



SANYO Semiconductors

# DATA SHEET

An ON Semiconductor Company

## LV59018M — Bi-CMOS LSI 1.8V Constant-Voltage Power Supply IC

### Overview

The LV59018M is a constant-voltage power supply IC incorporating the output ON/OFF function, which offers advantages such as small current drain when output OFF and saves power dissipation of the equipment.

### Features

- 1.8V output
- Output voltage ON/OFF function with the control pin (active, high)
- Output current of 1A obtainable ( $V_{IN1}, V_{IN2} \geq 2.8V$ )
- Small current drain (1 $\mu$ A max) when output OFF and optimum for power saving
- MFP8 (200mil) package, ensuring easy mounting design
- Full compliment of protection circuits incorporated (including overcurrent protection, thermal protection)

### Specifications

#### Absolute Maximum Ratings at $T_a = 25^\circ C$

Parameter	Symbol	Conditions	Ratings	Unit
Maximum power supply	$V_{IN1}$	$V_{IN1}$ pin	6.2	V
	$V_{IN2}$	$V_{IN2}$ pin	6.2	V
Allowable power dissipation	$P_d$ max	Mounted on a specified board.*	1.45	W
Operating Temperature	$T_{opr}$		-30 to +85	$^\circ C$
Storage Temperature	$T_{stg}$		-40 to +125	$^\circ C$

\* Specified board: 50mm  $\times$  50mm  $\times$  1.6mm, glass epoxy both sides

#### Recommended Operating Ranges at $T_a = 25^\circ C$

Parameter	Symbol	Conditions	Ratings	Unit
power supply	$V_{IN1}$	$V_{IN1}$ pin	1.9 to 6	V
	$V_{IN2}$	$V_{IN2}$ pin	1.9 to 6	V
Output current	$I_O$		0 to 1	A

■ Any and all SANYO Semiconductor Co.,Ltd. products described or contained herein are, with regard to "standard application", intended for the use as general electronics equipment (home appliances, AV equipment, communication device, office equipment, industrial equipment etc.). The products mentioned herein shall not be intended for use for any "special application" (medical equipment whose purpose is to sustain life, aerospace instrument, nuclear control device, burning appliances, transportation machine, traffic signal system, safety equipment etc.) that shall require extremely high level of reliability and can directly threaten human lives in case of failure or malfunction of the product or may cause harm to human bodies, nor shall they grant any guarantee thereof. If you should intend to use our products for applications outside the standard applications of our customer who is considering such use and/or outside the scope of our intended standard applications, please consult with us prior to the intended use. If there is no consultation or inquiry before the intended use, our customer shall be solely responsible for the use.

■ Specifications of any and all SANYO Semiconductor Co.,Ltd. products described or contained herein stipulate the performance, characteristics, and functions of the described products in the independent state, and are not guarantees of the performance, characteristics, and functions of the described products as mounted in the customer's products or equipment. To verify symptoms and states that cannot be evaluated in an independent device, the customer should always evaluate and test devices mounted in the customer's products or equipment.

# LV59018M

**Electrical Characteristics** at  $T_a = 25^\circ\text{C}$ ,  $V_{IN1} = V_{IN2} = 3\text{V}$

Parameter	Symbol	Conditions	Ratings			Unit
			min	typ	max	
Current drain	$I_{VIN}$	LDO ON		110	160	$\mu\text{A}$
Standby current	$I_{STBY}$	CTL = Low			1	$\mu\text{A}$
<b>Output</b>						
Output voltage	$V_O$	$I_O = 10\text{mA}$	1.767	1.8	1.836	V
Dropout voltage	$V_{drop1\_1}$	$I_O = 1\text{A}$			1	V
	$V_{drop1\_2}$	$I_O = 0.3\text{A}$			0.4	V
Load Regulation	$V_{LD}$	$I_O = 5\text{mA to } 1\text{A}$		10	50	mV
Line Regulation	$V_{LN}$	$V_{IN1} = V_{IN2} = 1.9\text{V to } 6\text{V}$ , $I_O = 10\text{mA}$		10	50	mV
Voltage temperature coefficient	$\Delta VT$	$T_a = -30 \text{ to } +85^\circ\text{C}$ , $I_O = 10\text{mA}$	*	$\pm 100$		ppm/ $^\circ\text{C}$
Ripple Rejection	$V_{RL}$	$I_O = 10\text{mA}$ , $V_{Rpp}=1\text{V}$ , $f_{RR} = 1\text{kHz}$	*	65		dB
Output Noise Voltage	$V_{ON}$	$20\text{Hz} < f < 20\text{kHz}$	*	100		$\mu\text{Vrms}$
<b>CTL pin</b>						
High level voltage	$V_{CTLH}$		1.5		5	V
Low level voltage	$V_{CTLL}$		0		0.3	V
Input current	$I_{CTL}$	$V_{CTL} = 6\text{V}$			8.5	$\mu\text{A}$

\* Design guarantee

## Package Dimensions

unit : mm (typ)

3372

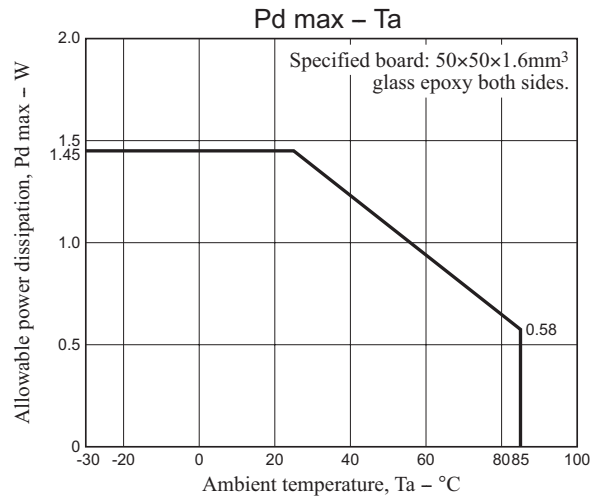
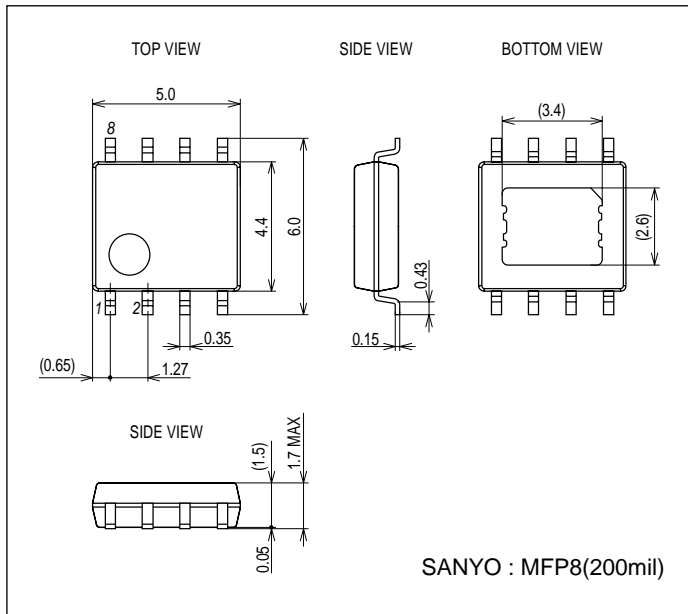

# LV59018M

## Pin Assignment

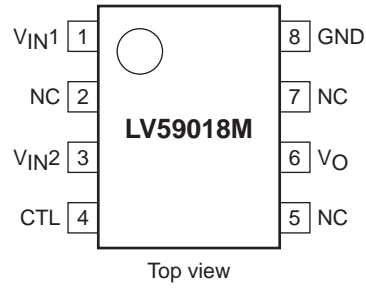

Specified Board (Top side)

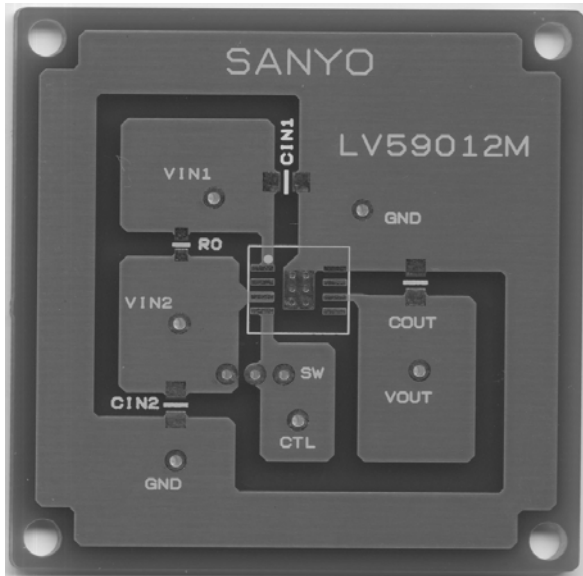

Specified Board (Bottom side)

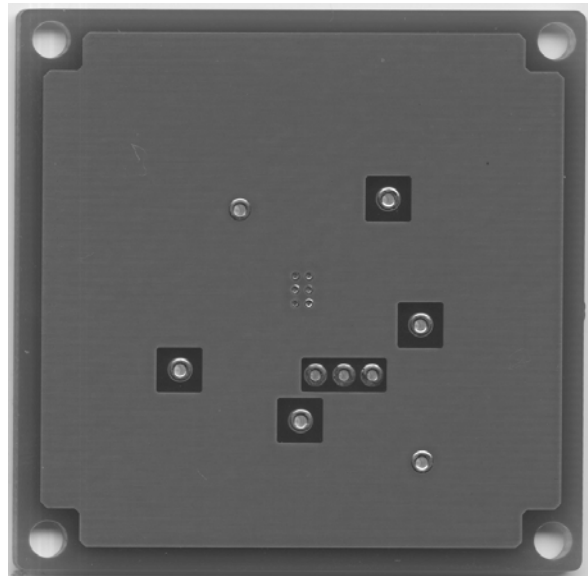

Note: The substrate is common with LV59012M.

## Block Diagram

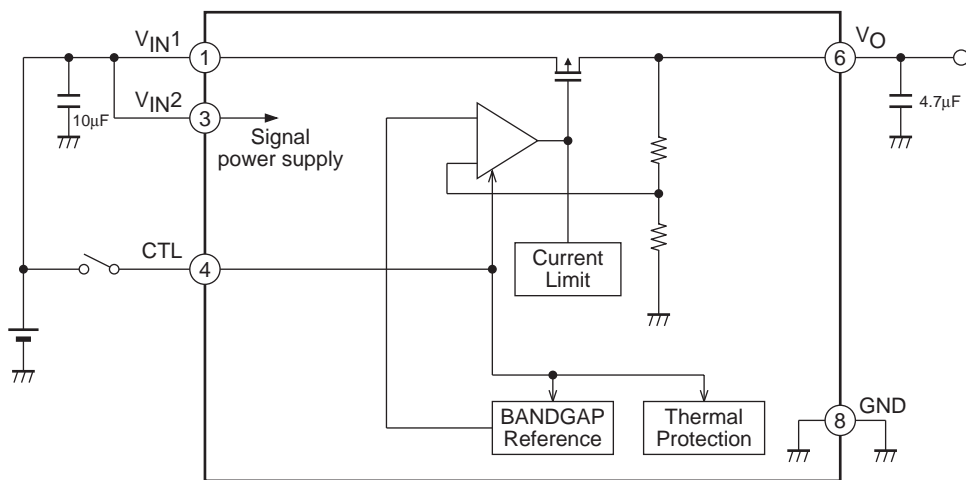

Pins 2,5,7 NC  
Connect and use V<sub>IN1</sub> and V<sub>IN2</sub>.

# LV59018M

## Pin Function

Pin No.	Pin name	Function	Equivalent circuit
1	V <sub>IN1</sub>	Power system supply pin.	
6	V <sub>O</sub>	Output voltage pin.	
2	NC	No contact.	
3	V <sub>IN2</sub>	Signal system power supply pin.	
4	CTL	ON/OFF control pin.	
5	NC	No contact.	
7	NC	No contact.	
8	GND	Ground pin.	

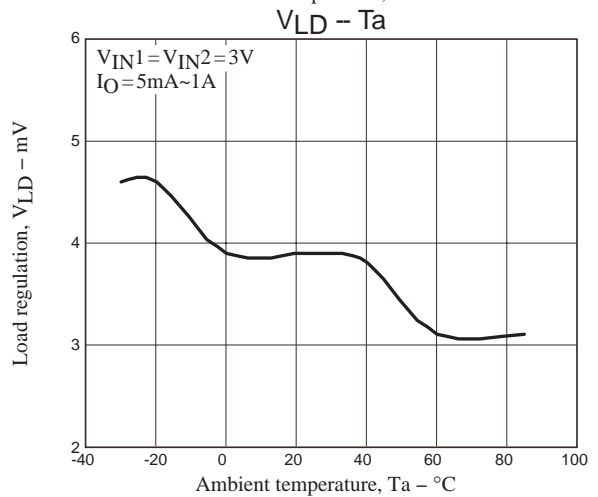
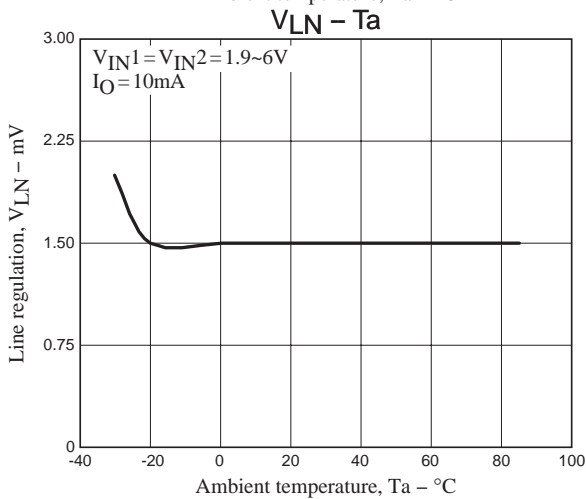
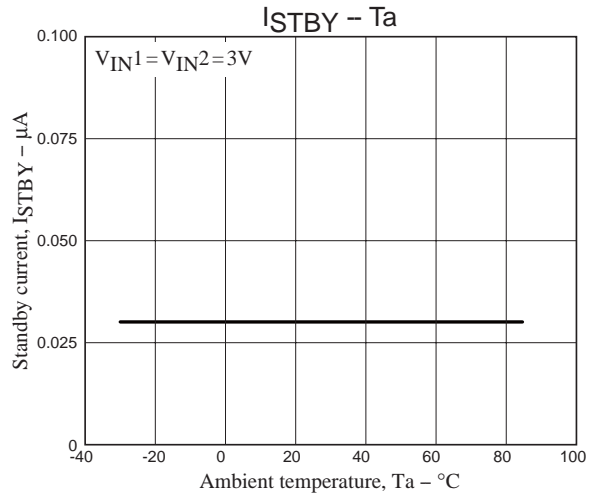
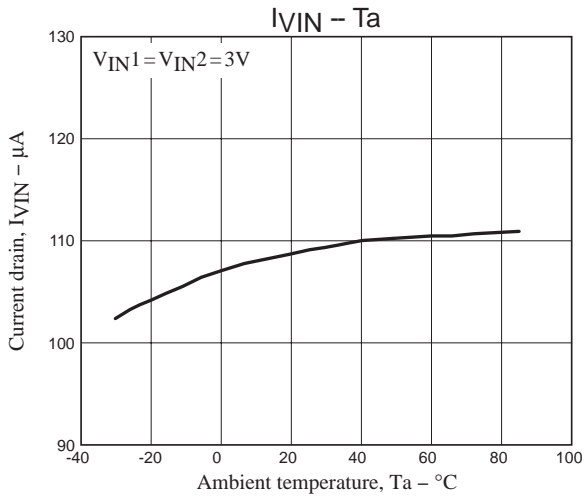

# LV59018M

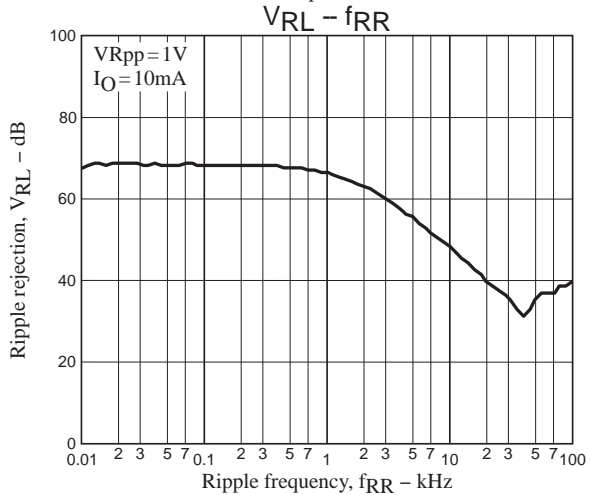
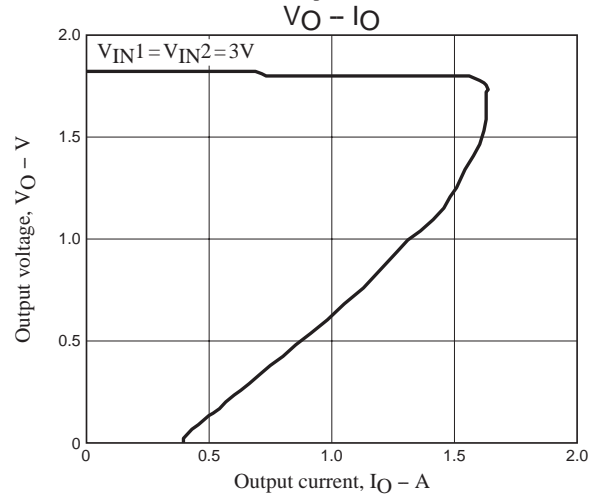
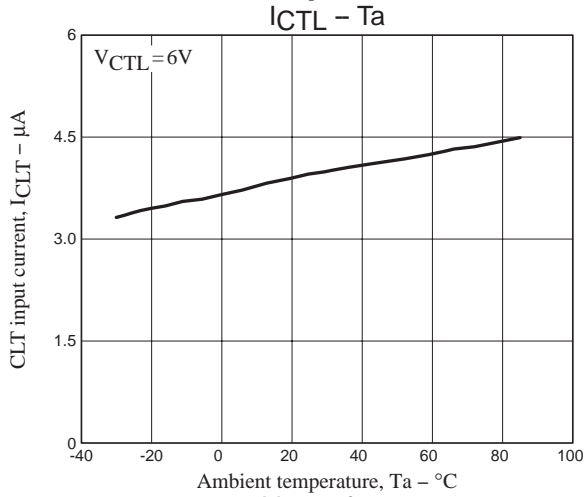
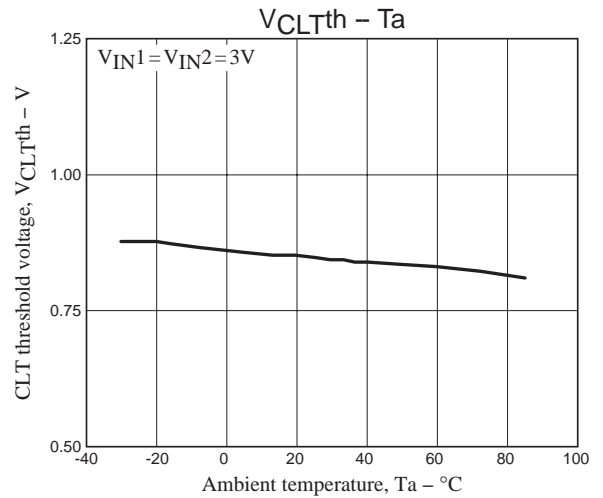
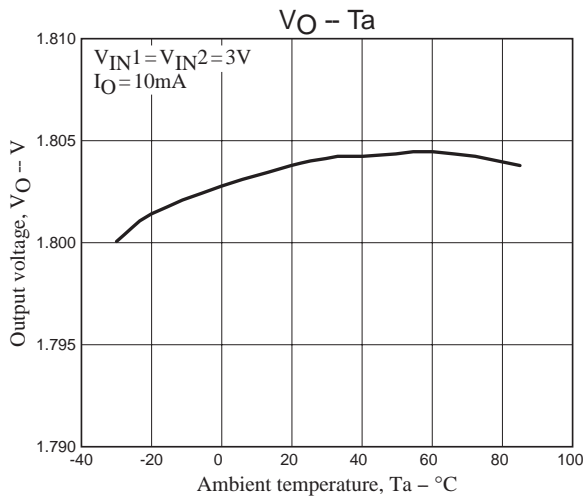
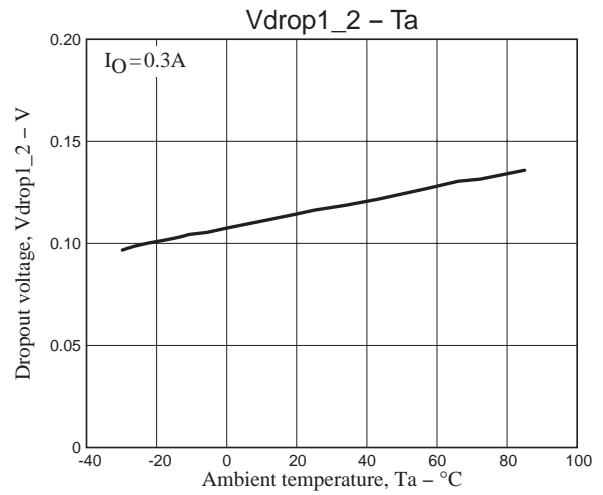
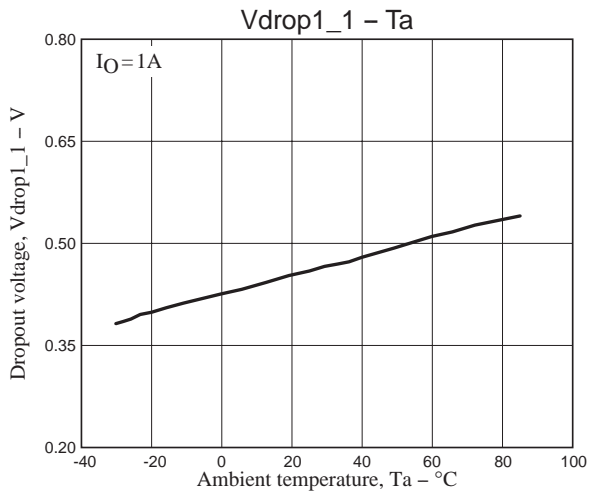

# LV59018M

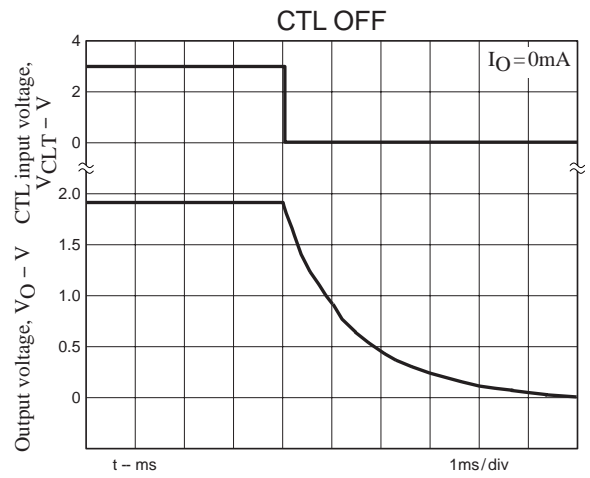
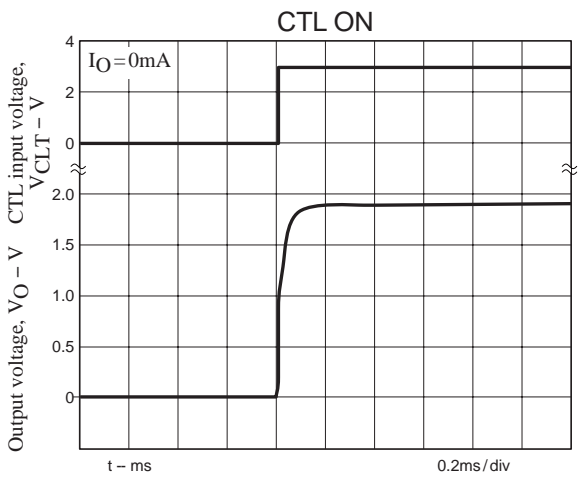
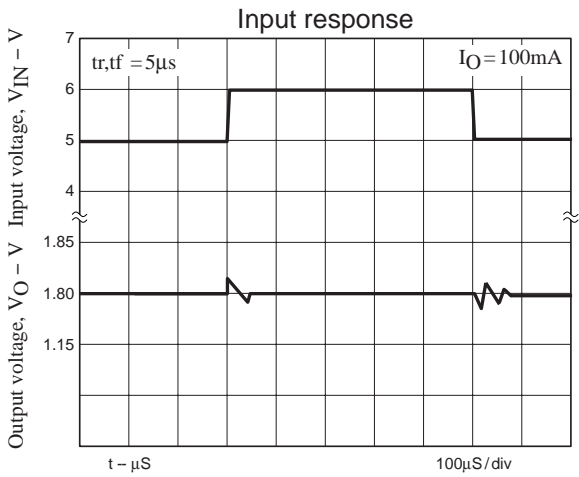
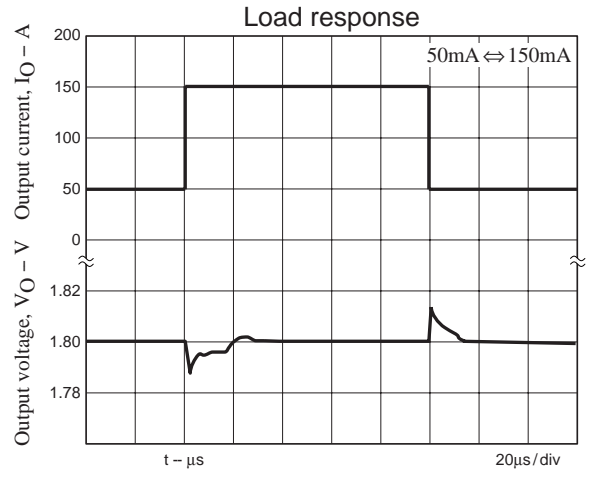
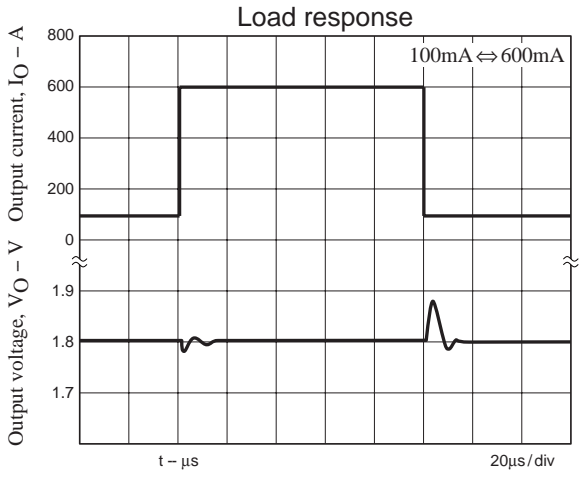

## Radiation Pad

- Radiation pad is high impedance and connected with a substrate of IC.
- Use radiation pad by GND or opening.

- SANYO Semiconductor Co.,Ltd. assumes no responsibility for equipment failures that result from using products at values that exceed, even momentarily, rated values (such as maximum ratings, operating condition ranges, or other parameters) listed in products specifications of any and all SANYO Semiconductor Co.,Ltd. products described or contained herein.
- SANYO Semiconductor Co.,Ltd. strives to supply high-quality high-reliability products, however, any and all semiconductor products fail or malfunction with some probability. It is possible that these probabilistic failures or malfunction could give rise to accidents or events that could endanger human lives, trouble that could give rise to smoke or fire, or accidents that could cause damage to other property. When designing equipment, adopt safety measures so that these kinds of accidents or events cannot occur. Such measures include but are not limited to protective circuits and error prevention circuits for safe design, redundant design, and structural design.
- In the event that any or all SANYO Semiconductor Co.,Ltd. products described or contained herein are controlled under any of applicable local export control laws and regulations, such products may require the export license from the authorities concerned in accordance with the above law.
- No part of this publication may be reproduced or transmitted in any form or by any means, electronic or mechanical, including photocopying and recording, or any information storage or retrieval system, or otherwise, without the prior written consent of SANYO Semiconductor Co.,Ltd.
- Any and all information described or contained herein are subject to change without notice due to product/technology improvement, etc. When designing equipment, refer to the "Delivery Specification" for the SANYO Semiconductor Co.,Ltd. product that you intend to use.
- Information (including circuit diagrams and circuit parameters) herein is for example only; it is not guaranteed for volume production.
- Upon using the technical information or products described herein, neither warranty nor license shall be granted with regard to intellectual property rights or any other rights of SANYO Semiconductor Co.,Ltd. or any third party. SANYO Semiconductor Co.,Ltd. shall not be liable for any claim or suits with regard to a third party's intellectual property rights which has resulted from the use of the technical information and products mentioned above.

This catalog provides information as of September, 2010. Specifications and information herein are subject to change without notice.