



MIC2206

2MHz PWM Synchronous Buck Regulator with LOWQ Mode and Voltage Scaling

General Description

The Micrel MIC2206 is a high efficiency 2MHz PWM synchronous buck (step-down) regulator that features a *LOWQ™* LDO standby mode that draws only 18 μ A of quiescent current. The MIC2206 allows an ultra-low noise, small size, and high efficiency solution for portable power applications.

In PWM mode, the MIC2206 operates with a constant frequency 2MHz PWM control. Under light load conditions, such as in system sleep or standby modes, the PWM switching operation can be disabled to reduce switching losses. In this light load *LOWQ™* mode, the LDO maintains an output voltage of 1V and draws only 18 μ A of quiescent current. The LDO mode of operation saves battery life while not introducing spurious noise and high ripple as experienced with pulse skipping or bursting mode regulators.

The MIC2206 operates from 2.7V to 5.5V input and features internal power MOSFETs that can supply up to 600mA output current in PWM mode. It can operate with a maximum duty cycle of 100% for use in low-dropout conditions.

The MIC2206 is available in the 3mm x 3mm MLF-10L package with a junction operating range from -40°C to +125°C.

Data sheets and support documentation can be found on Micrel's web site at www.micrel.com.

Features

- 2.7 to 5.5V supply voltage
- Light load *LOWQ™* LDO mode
 - 18 μ A quiescent current
 - Low noise, 75 μ Vrms
- 2MHz PWM mode
 - Output current to 600mA
 - >95% efficiency
 - 100% maximum duty cycle
- Output Voltage Scaling (1V output in *LOWQ* Mode)
- Ultra-fast transient response
- Stable with 1 μ F ceramic output capacitor
- Fully integrated MOSFET switches
- Micropower shutdown
- Thermal shutdown and current limit protection
- Pb-free 3mm x 3mm MLF-10L package
- -40°C to +125°C junction temperature range

Applications

- Cellular phones
- PDAs
- USB peripherals

Typical Application

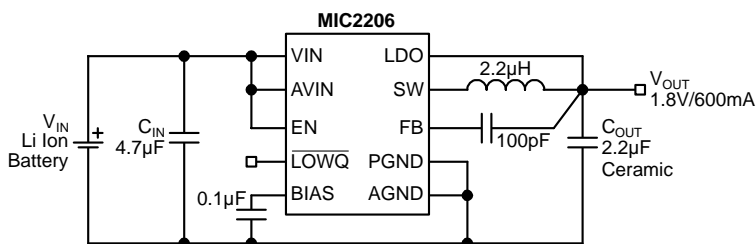

Fixed Output Buck Regulator with *LOWQ™* Mode

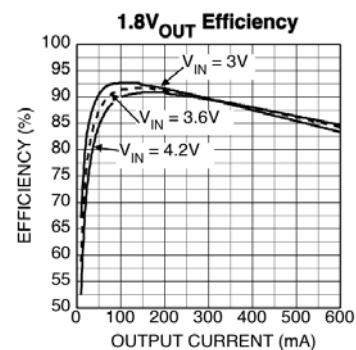

LOWQ is a trademark of Micrel, Inc

Micrel, Inc. • 2180 Fortune Drive • San Jose, Ca 95131 • USA • tel +1 (408) 944-0800 • fax +1 (408) 474-1000 • <http://www.micrel.com>

October 2005

M9999-102105

www.micrel@micrel.com

Ordering Information

Part Number (Pb-Free)	Output Voltage ⁽¹⁾ (PWM/LDO)	Junction Temp. Range	Package
MIC2206-1.8YML	1.8V/1.0V	-40° to +125°C	3x3 MLF-10L
MIC2206-1.2YML	1.2V/1.0V	-40° to +125°C	3x3 MLF-10L

Note:

- Other Voltage options available. Contact Micrel for details.

Pin Configuration

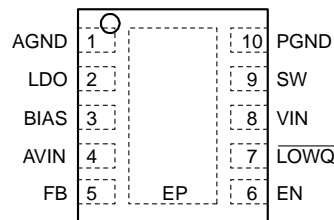

3mm x 3mm MLF-10L (ML)

Pin Description

Pin Number	Pin Name	Pin Function
1	AGND	Analog (signal) Ground.
2	LDO	LDO Output (Output): Connect to V_{OUT} for LDO mode operation.
3	BIAS	Internal circuit bias supply. Must be de-coupled to signal ground with a 0.1 μ F capacitor and should not be loaded.
4	AVIN	Analog Supply Voltage (Input): Supply voltage for the analog control circuitry and LDO input power. Requires bypass capacitor to GND.
5	FB	Feedback. Input to the error amplifier and internal feedback resistors. Place a 100pF ceramic capacitor from FB to the output.
6	EN	Enable (Input). Logic low will shut down the device, reducing the quiescent current to less than 5 μ A.
7	$\overline{\text{LOWQ}}$	Enable LDO Mode (Input): Logic low enables the internal LDO and disables the PWM operation. Logic high enables the PWM mode and disables the LDO mode.
8	VIN	Supply Voltage (Input): Supply voltage for the internal switches and drivers.
9	SW	Switch (Output): Internal power MOSFET output switches.
10	PGND	Power Ground.
EP	GND	Ground, backside pad.

Absolute Maximum Ratings⁽¹⁾

Supply Voltage (V_{IN})	+6V
Output Switch Voltage (V_{SW})	+6V
Output Switch Current (I_{SW})	2A
Logic Input Voltage (V_{EN}, V_{LOWQ})	-0.3V to V_{IN}
Storage Temperature (T_s)	-60°C to +150°C
ESD Rating ⁽³⁾	3kV

Operating Ratings⁽²⁾

Supply Voltage (V_{IN})	+2.7V to +5.5V
Logic Input Voltage (V_{EN}, V_{LOWQ})	-0.3V to V_{IN}
Junction Temperature (T_J)	-40°C to +125°C
Junction Thermal Resistance	
3x3 MLF-10L (θ_{JA})	60°C/W

Electrical Characteristics⁽⁴⁾

$V_{IN} = V_{EN} = V_{LOWQ} = 3.6V$; $L = 2.2\mu H$; $C_{OUT} = 2.2\mu F$; $T_A = 25^\circ C$, unless noted. **Bold** values indicate $-40^\circ C \leq T_J \leq +125^\circ C$

Parameter	Condition	Min	Typ	Max	Units
Supply Voltage Range		2.7		5.5	V
Under-Voltage Lockout Threshold	(turn-on)	2.45	2.55	2.65	V
UVLO Hysteresis			100		mV
Quiescent Current, PWM mode	$V_{FB} = 0.9 * V_{NOM}$ (not switching)		690	900	μA
Quiescent Current, LDO mode	$V_{LOWQ} = 0V; I_{OUT} = 0mA$		16	29	μA
Shutdown Current	$V_{EN} = 0V$		0.1	5	μA
[Fixed Output] Voltages	Nominal V_{OUT} tolerance	-1 -2		+1 +2	%
Current Limit in PWM Mode	$V_{FB} = 0.9 * V_{NOM}$	0.75	1	1.85	A
Output Voltage Line Regulation	$V_{OUT} > 2V; V_{IN} = V_{OUT} + 300mV$ to 5.5V; $I_{LOAD} = 100mA$ $V_{OUT} < 2V; V_{IN} = 2.7V$ to 5.5V; $I_{LOAD} = 100mA$		0.13		%
Output Voltage Load Regulation, PWM Mode	$20mA < I_{LOAD} < 300mA$		0.2	0.5	%
Output Voltage Load Regulation, LDO Mode	$100\mu A < I_{LOAD} < 50mA$ $V_{LOWQ} = 0V$		0.2	0.5	%
Maximum Duty Cycle	$V_{FB} \leq 0.4V$	100			%
PWM Switch ON-Resistance	$I_{SW} = 50mA$ $V_{FB} = 0.7V_{FB_NOM}$ (High Side Switch) $I_{SW} = -50mA$ $V_{FB} = 1.1V_{FB_NOM}$ (Low Side Switch)		0.4 0.4		Ω
Oscillator Frequency		1.8	2	2.2	MHz
LOWQ threshold voltage		0.5	0.85	1.3	V
LOWQ Input Current			0.1	2	μA
Enable Threshold		0.5	0.85	1.3	V
Enable Input Current			0.1	2	μA

Parameter	Condition	Min	Typ	Max	Units
Output Voltage Noise	$\overline{\text{LOWQ}} = 0\text{V}$; $C_{\text{OUT}} = 2.2 \mu\text{F}$, 10Hz to 100kHz		75		μVrms
LDO Current Limit	$\overline{\text{LOWQ}} = 0\text{V}$; $V_{\text{OUT}} = 0\text{V}$ (LDO Mode)	60	120		mA
Over-Temperature Shutdown			160		$^{\circ}\text{C}$
Over-Temperature Hysteresis			20		$^{\circ}\text{C}$

Notes:

1. Exceeding the absolute maximum rating may damage the device.
2. The device is not guaranteed to function outside its operating rating.
3. Devices are ESD sensitive. Handling precautions recommended. Human body model: 1.5k Ω in series with 100pF.
4. Specification for packaged product only.

Typical Characteristics – PWM Mode

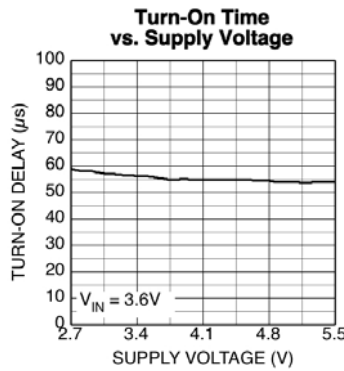
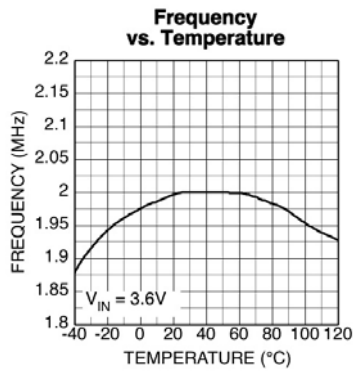
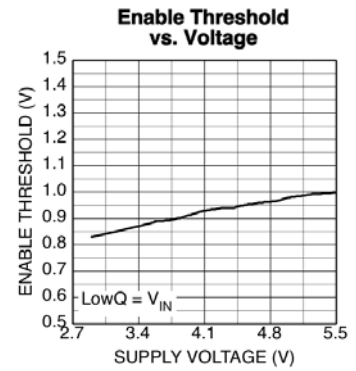
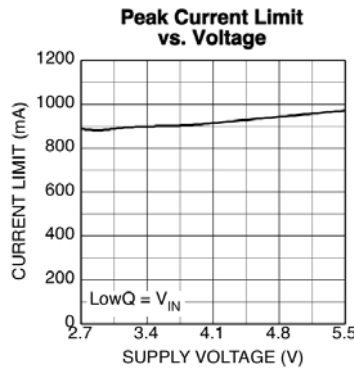
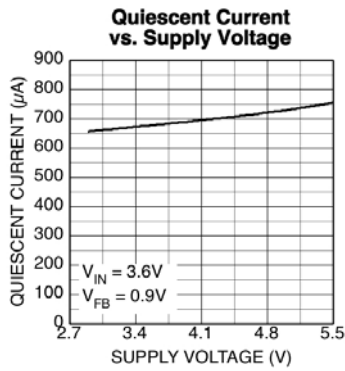
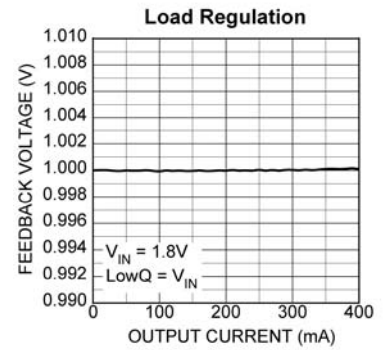
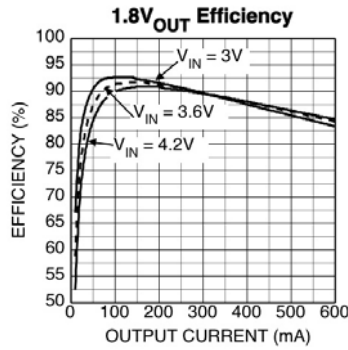
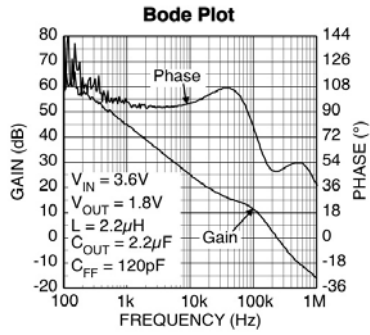

Typical Characteristics - LDO Mode

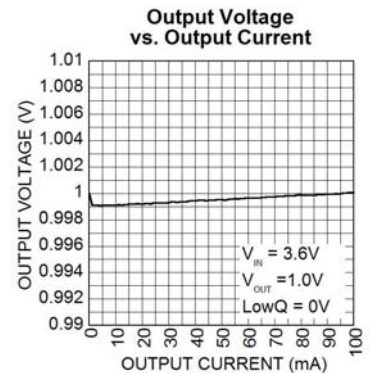
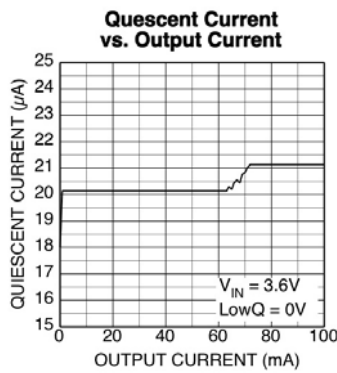
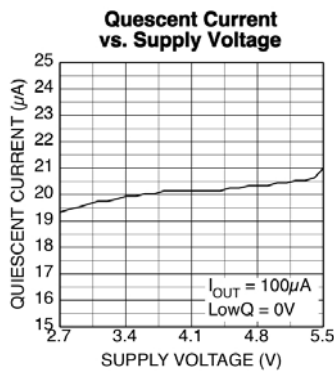
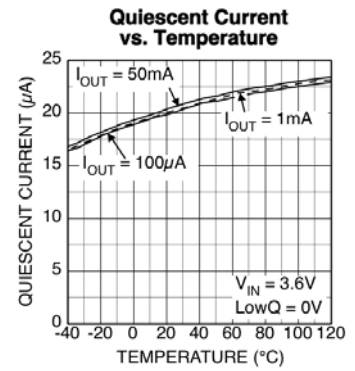
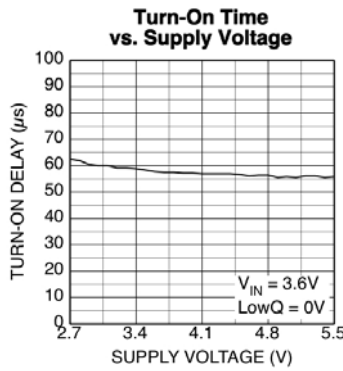
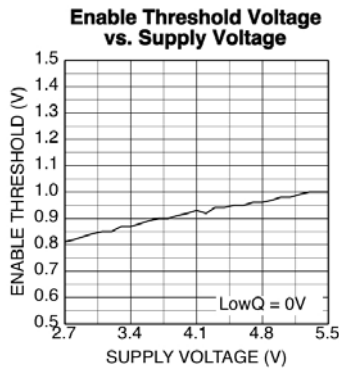
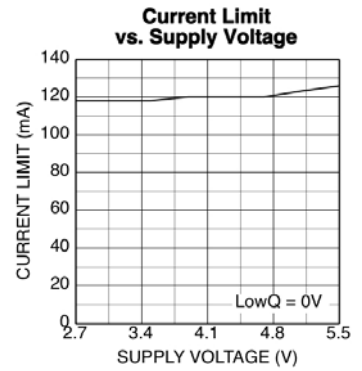
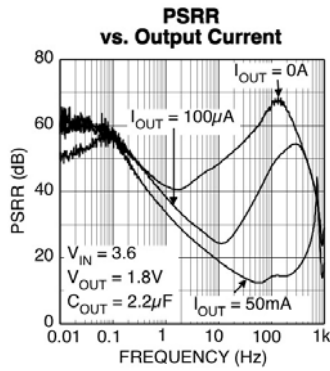
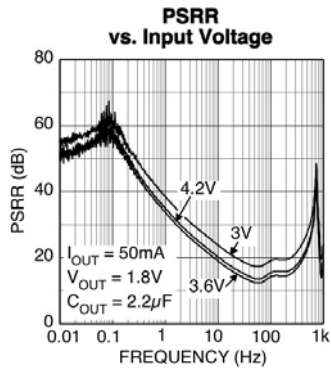

Functional Diagram

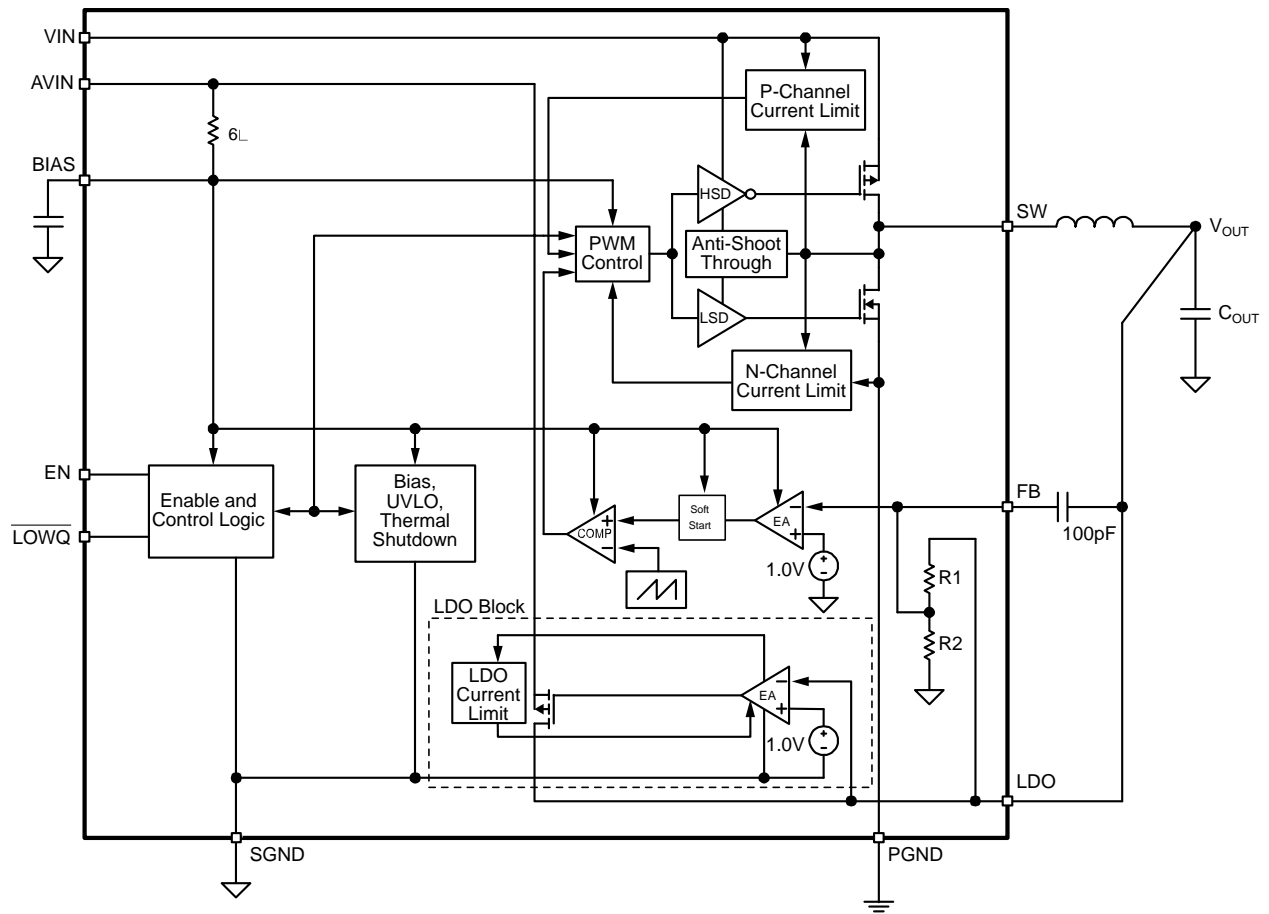

MIC2206 Block Diagram

Functional Characteristics

Load Transient PWM Mode

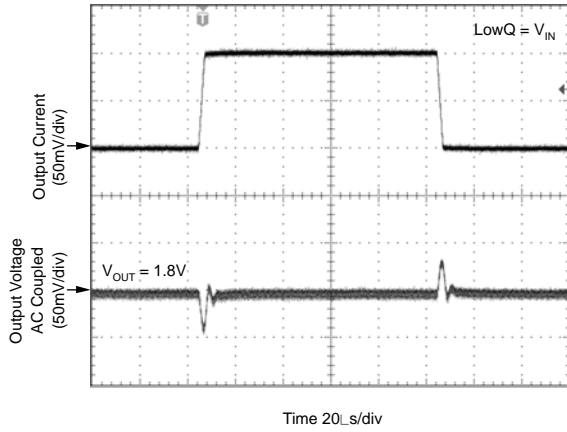

Load Transient LDO Mode

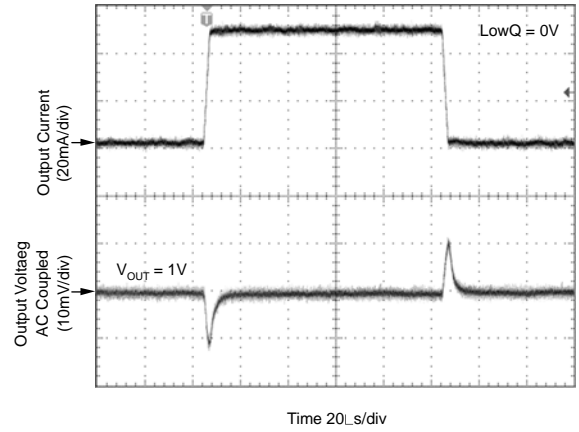

Enable Transient PWM Mode

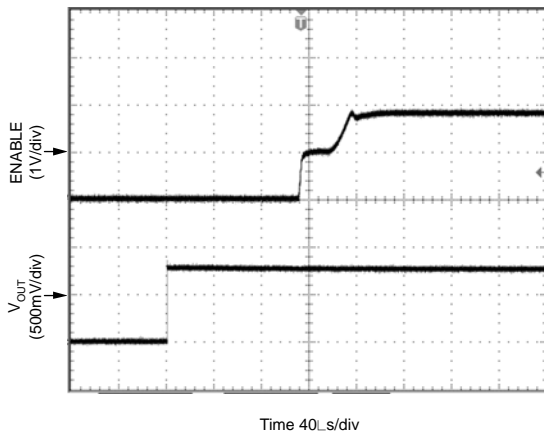

Enable Transient LDO Mode

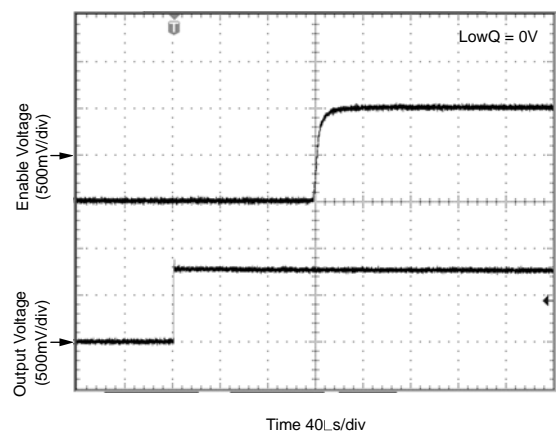

PWM Waveform

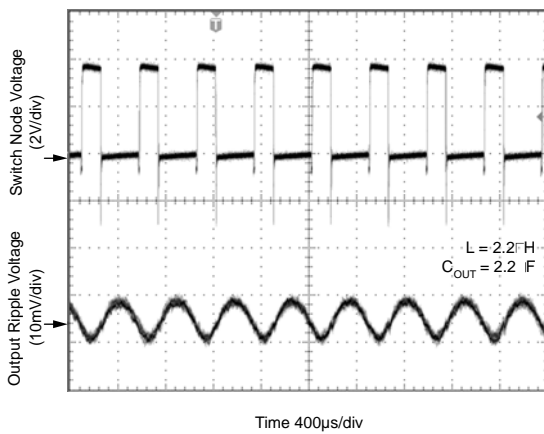

PWM Mode to LDO Mode Transition

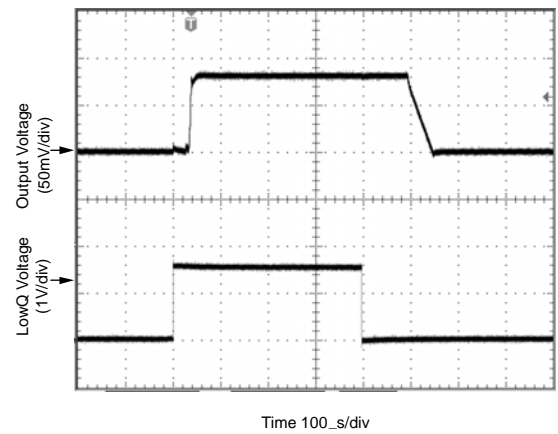

Functional Description

VIN

VIN provides power to the MOSFETs for the switch mode regulator section, along with the current limiting sensing. Due to the high switching speeds, a 1 μ F capacitor is recommended close to VIN and the power ground (PGND) pin for bypassing.

AVIN

Analog V_{IN} (AVIN) provides power to the LDO section and the bias through an internal 6 Ohm resistor. AVIN and VIN must be tied together. Careful layout should be considered to ensure high frequency switching noise caused by VIN is reduced before reaching AVIN.

LDO

The LDO pin is the output of the linear regulator and should be connected to the output. In LOWQ mode (LOWQ<1.5V), the LDO provides the output voltage. In PWM mode (LOWQ>1.5V) the LDO pin is high impedance.

EN

The enable pin provides a logic level control of the output. In the off state, supply current of the device is greatly reduced (typically <1 μ A). Also, in the off state, the output drive is placed in a "tri-stated" condition, where both the high side P-channel Mosfet and the low-side N-channel are in an off or non-conducting state. Do not drive the enable pin above the supply voltage.

LOWQ

The $\overline{\text{LOWQ}}$ pin provides a logic level control between the internal PWM mode and the low noise linear regulator mode. With LOWQ pulled low (<0.5V), quiescent current of the device is greatly reduced by switching to a low noise linear regulator mode that has a typical I_Q of 18 μ A. In linear (LDO) mode the output can deliver 60mA of current at 1.0V to the output. By placing $\overline{\text{LOWQ}}$ high (>1.5V), this transitions the device into a constant frequency PWM buck regulator mode. This allows the device the ability to efficiently deliver up to 600mA of output current at the same output voltage.

BIAS

The BIAS pin supplies the power to the internal power to the control and reference circuitry. The bias is powered from AVIN through an internal 6 Ω resistor. A small 0.1 μ F capacitor is recommended for bypassing.

FB

The feedback pin (FB) provides the connection to the internal FB resistor divider. Place a small 100pF ceramic capacitor between FB and the output voltage.

SW

The switch (SW) pin connects directly to the inductor and provides the switching current necessary to operate in PWM mode. Due to the high speed switching on this pin, the switch node should be routed away from sensitive nodes.

PGND

Power ground (PGND) is the ground path for the high current PWM mode. The current loop for the power ground should be as small as possible and separate from the Analog ground (AGND) loop. Refer to the layout considerations for more details.

SGND

Signal ground (SGND) is the ground path for the biasing and control circuitry. The current loop for the signal ground should be separate from the Power ground (PGND) loop. Refer to the layout considerations for more details.

Applications Information

The MIC2206 is a 600mA PWM power supply that utilizes a LOWQ™ light load mode to maximize battery efficiency in light load conditions. This is achieved with a LOWQ control pin that when pulled low, shuts down all the biasing and drive current for the PWM regulator, drawing only 18μA of operating current. This allows the output to be scaled down and regulated to 1.0V through the LDO output, capable of providing 60mA of output current. This method has the advantage of producing a clean, low current, ultra low noise output in LOWQ™ mode. During LOWQ™ mode, the SW node becomes high impedance, blocking current flow. Other methods of reducing quiescent current, such as pulse frequency modulation (PFM) or bursting techniques create large amplitude, low frequency ripple voltages that can be detrimental to system operation.

When more than 60mA is required, the $\overline{\text{LOWQ}}$ pin can be forced high, causing the MIC2206 to enter PWM mode. In this case, the LDO output makes a "hand-off" to the PWM regulator. The LDO output then turns off allowing up to 600mA of current to be efficiently supplied through the PWM output to the load.

Input Capacitor

A minimum 1μF ceramic is recommended on the VIN pin for bypassing. X5R or X7R dielectrics are recommended for the input capacitor. Y5V dielectrics lose most of their capacitance over temperature and are therefore not recommended.

A minimum 1μF is recommended close to the VIN and PGND pins for high frequency filtering. Smaller case size capacitors are recommended due to their lower ESR and ESL.

Output Capacitor

Even though the MIC2206 is optimized for a 2.2μF output capacitor, output capacitance can be varied from 1μF to 4.7μF. The MIC2206 utilizes type III internal compensation and utilizes an internal high frequency zero to compensate for the double pole roll off of the LC filter. For this reason, larger output capacitors can create instabilities. X5R or X7R dielectrics are recommended for the output capacitor. Y5V dielectrics lose most of their capacitance over temperature and are therefore not recommended.

In addition to a 2.2μF, a small 10nF is recommended close to the load for high frequency filtering. Smaller case size capacitors are recommended due to their lower ESR and ESL.

Inductor Selection

The MIC2206 is designed for use with a 2.2μH inductor. Proper selection should ensure the inductor can handle the maximum average and peak currents required by the load. Maximum current ratings of the inductor are generally given in two methods; permissible DC current and saturation current. Permissible DC current can be rated either for a 40°C temperature rise or a 10% to 20% loss in inductance. Ensure the inductor selected can handle the maximum operating current. When saturation current is specified, make sure that there is enough margin that the peak current will not saturate the inductor. Peak inductor current can be calculated as follows:

$$I_{PK} = I_{OUT} + \frac{V_{OUT} \left(1 - \frac{V_{OUT}}{V_{IN}} \right)}{2 \times f \times L}$$

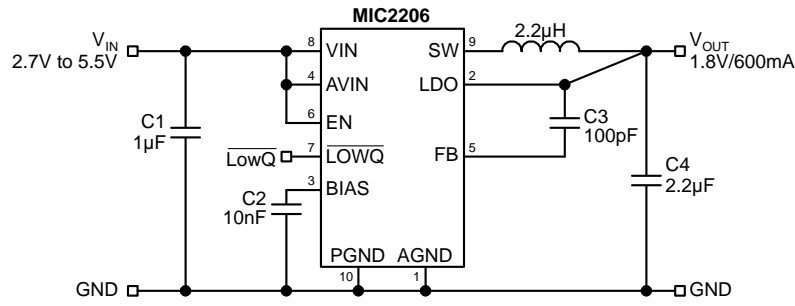

Item	Part Number	Description	Manufacturer	Qty
C1	06036D105MAT2 GRM185R60J105KE21D	1µF Ceramic Capacitor X5R, 6.3V 0603 1µF Ceramic Capacitor X5R, 6.3V 0603	AVX Murata	1
C4	06036D225MAT2 GRM188R61A225KE34	2.2µF Ceramic Capacitor X5R, 10V 0603 2.2µF Ceramic Capacitor X5R, 10V 0603	AVX Murata	1
C3	VJ0402A101KXAA	100pF Ceramic Capacitor	Vishay	1
C2	0201ZD103MAT2 GRM033R10J103KA01D	10nF Ceramic Capacitor 6.3V 0201 10nF Ceramic Capacitor 6.3V 0201	AVX Murata	1
L1	LQH32CN2R2M53K CDRH2D14-2R2	2.2µH Inductor 97mΩ 3.2mmx2.5mmx1.55mm 2.2µH Inductor 94mΩ 3.2mmx3.2mmx1.55mm	Murata Sumida	1
U1	MIC2206BML	2MHz Synchronous Buck Regulator with LOWQ™ Mode	Micrel Semiconductor	1

Notes:

Sumida Tel: 408-982-9660

Murata Tel: 949-916-4000

Vishay Tel: 402-644-4218

Micrel Semiconductor Tel: 408-944-0800

Package Information

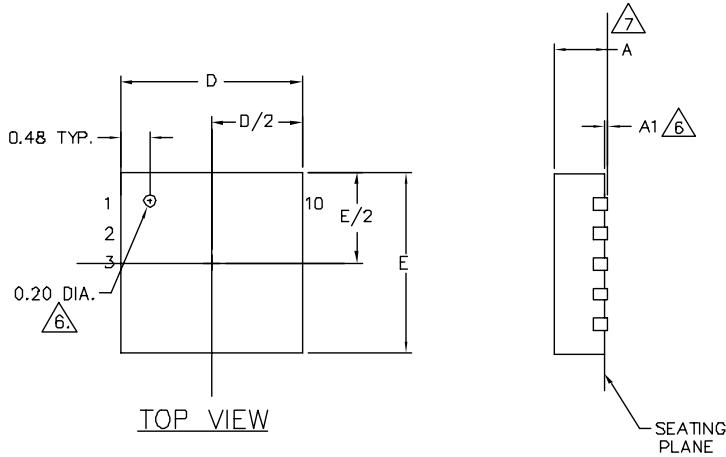

	DIMENSION (mm)		
	MIN.	NOM.	MAX.
A	0.80	0.85	1.00
A1	0.00	0.01	0.05
D	3.00 BSC		
D2	1.45	1.60	1.75
E	3.00 BSC		
E2	2.15	2.30	2.45
e	0.50 BSC		
L	0.35	0.40	0.55
b	0.18	0.23	0.30

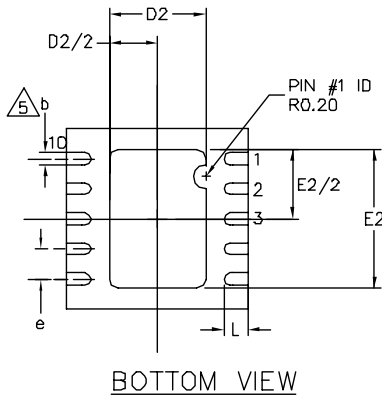

- NOTE:
1. ALL DIMENSIONS ARE IN MILLIMETERS.
 2. MAX. PACKAGE WARPAGE IS 0.05 mm.
 3. MAXIMUM ALLOWABLE BURRS IS 0.076 mm IN ALL DIRECTIONS.
 4. PIN #1 ID ON TOP WILL BE LASER/INK MARKED.
- ⚠ DIMENSION b APPLIES TO METALIZED TERMINAL AND IS MEASURED BETWEEN 0.20 AND 0.25 mm FROM TERMINAL TIP.
- ⚠ APPLIED ONLY FOR TERMINALS.
- ⚠ APPLIED FOR EXPOSED PAD AND TERMINALS.

10-Lead MLF™ (ML)

MICREL, INC. 2180 FORTUNE DRIVE SAN JOSE, CA 95131 USA
 TEL +1 (408) 944-0800 FAX +1 (408) 474-1000 WEB <http://www.micrel.com>

The information furnished by Micrel in this data sheet is believed to be accurate and reliable. However, no responsibility is assumed by Micrel for its use. Micrel reserves the right to change circuitry and specifications at any time without notification to the customer.

Micrel Products are not designed or authorized for use as components in life support appliances, devices or systems where malfunction of a product can reasonably be expected to result in personal injury. Life support devices or systems are devices or systems that (a) are intended for surgical implant into the body or (b) support or sustain life, and whose failure to perform can be reasonably expected to result in a significant injury to the user. A Purchaser's use or sale of Micrel Products for use in life support appliances, devices or systems is a Purchaser's own risk and Purchaser agrees to fully indemnify Micrel for any damages resulting from such use or sale.

© 2005 Micrel, Incorporated.