

# BIPOLAR ANALOG INTEGRATED CIRCUIT

## $\mu$ PC2900 Series

### THREE TERMINAL LOW DROPOUT VOLTAGE REGULATOR

The  $\mu$ PC2900 series of low dropout voltage three terminal positive regulators is constructed with PNP output transistor. The  $\mu$ PC2900 series feature the ability to source 1 A of output current with a low dropout voltage of typically 0.7 V.

The power dissipation of the  $\mu$ PC2900 series can be drastically reduced compared with the conventional three terminal positive voltage regulators that is constructed with NPN output transistor. Also, this series corresponds to the low voltage output (3 V, 3.3 V) which is not in the conventional low dropout regulators ( $\mu$ PC2400A series).

#### FEATURES

- Output current in excess of 1.0 A
- Low dropout voltage  $V_{DIF} = 0.7$  V TYP. (at  $I_o = 1$  A)
- On-chip overcurrent and thermal protection circuit
- On-chip output transistor safe area protection circuit

#### PIN CONFIGURATION (Marking Side)

$\mu$ PC2900HF Series: MP-45G

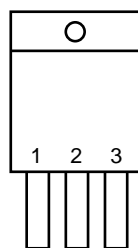

1: INPUT  
2: GND  
3: OUTPUT

$\mu$ PC2900HB Series: MP-3

$\mu$ PC2900T Series: MP-3Z

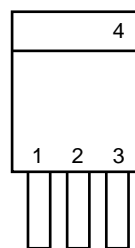

1: INPUT  
2: GND  
3: OUTPUT  
4: GND (Fin)

The information in this document is subject to change without notice.

**BLOCK DIAGRAM**

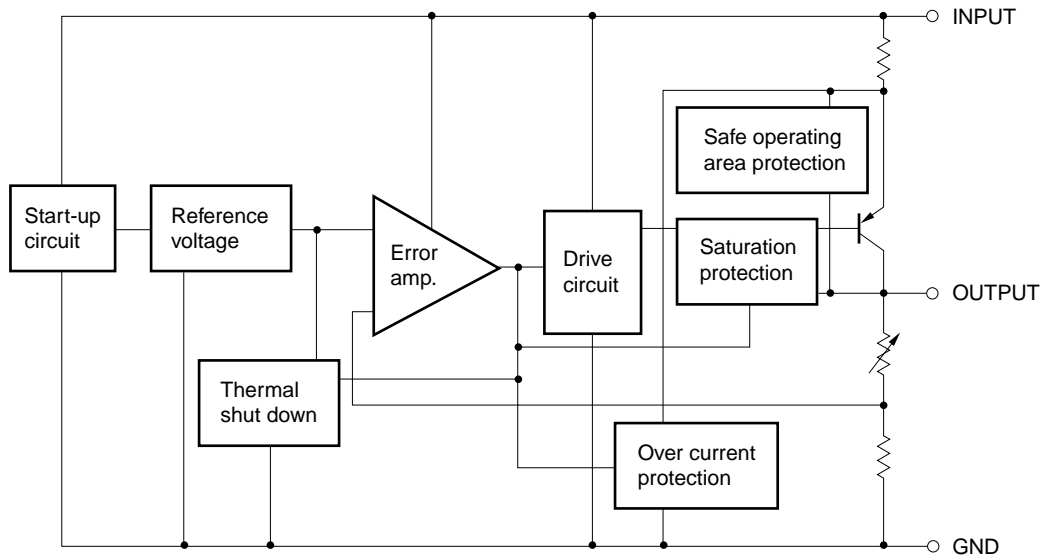

**ORDERING INFORMATION**

Part Number	Package	Output Voltage
μPC2903HF	MP-45G (Isolated TO-220)	3.0 V
μPC2903HB	MP-3 (SC-64)	3.0 V
μPC2903T	MP-3Z (SC-63)	3.0 V
μPC2933HF	MP-45G (Isolated TO-220)	3.3 V
μPC2933HB	MP-3 (SC-64)	3.3 V
μPC2933T	MP-3Z (SC-63)	3.3 V
μPC2905HF	MP-45G (Isolated TO-220)	5.0 V
μPC2905HB	MP-3 (SC-64)	5.0 V
μPC2905T	MP-3Z (SC-63)	5.0 V
★ μPC2906HF	MP-45G (Isolated TO-220)	6.0 V
★ μPC2906HB	MP-3 (SC-64)	6.0 V
★ μPC2906T	MP-3Z (SC-63)	6.0 V
★ μPC2907HF	MP-45G (Isolated TO-220)	7.0 V
★ μPC2907HB	MP-3 (SC-64)	7.0 V
★ μPC2907T	MP-3Z (SC-63)	7.0 V
μPC2908HF	MP-45G (Isolated TO-220)	8.0 V
μPC2908HB	MP-3 (SC-64)	8.0 V
μPC2908T	MP-3Z (SC-63)	8.0 V
μPC2909HF	MP-45G (Isolated TO-220)	9.0 V
μPC2909HB	MP-3 (SC-64)	9.0 V
μPC2909T	MP-3Z (SC-63)	9.0 V
μPC2910HF	MP-45G (Isolated TO-220)	10.0 V
μPC2910HB	MP-3 (SC-64)	10.0 V
μPC2910T	MP3Z (SC-63)	10.0 V
μPC2912HF	MP-45G (Isolated TO-220)	12.0 V
μPC2912HB	MP-3 (SC-64)	12.0 V
μPC2912T	MP-3Z (SC-63)	12.0 V

**ABSOLUTE MAXIMUM RATINGS (T<sub>A</sub> = 25 °C, Unless otherwise specified.)**

Parameter	Symbol	Rating		Unit
		μPC2900HF	μPC2900HB, μPC2900T	
Input Voltage	V <sub>IN</sub>	20		V
Internal Power Dissipation <sup>Note</sup>	P <sub>T</sub>	15	10	W
Operating Ambient Temperature	T <sub>A</sub>	-30 to +85		°C
Operating Junction Temperature	T <sub>J</sub>	-30 to +150		°C
Storage Temperature	T <sub>stg</sub>	-55 to +150		°C
Thermal Resistance (Junction to Case)	R <sub>th (J-C)</sub>	7	12.5	°C/W
Thermal Resistance (Junction to Ambient)	R <sub>th (J-A)</sub>	65	125	°C/W

**Note** T<sub>C</sub> = 25 °C, Internally limited

When operating junction temperature rises up to 150 °C, the internal circuit shutdown output voltage.

**Caution** Exposure to Absolute Maximum Ratings for extended periods may affect device reliability; exceeding the ratings could cause permanent damage. The parameters apply independently. The device should be operated within the limits specified under DC and AC Characteristics.

**TYPICAL CONNECTION**

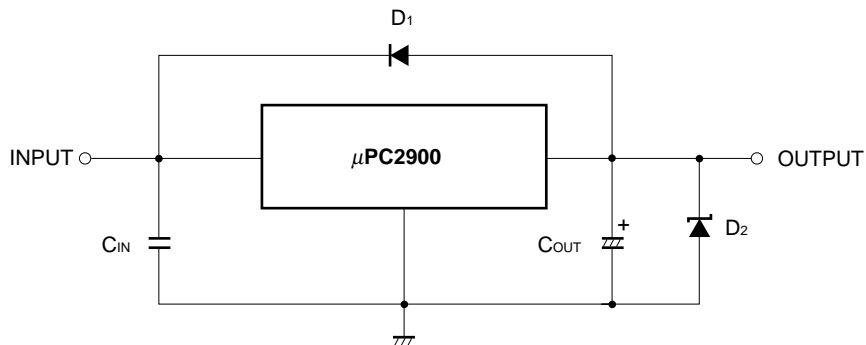

C<sub>IN</sub> : More than 0.1 μF. Required if regulator is located an appreciable distance from power supply filter. You must use to prevent from the parasitic oscillation.

C<sub>OUT</sub> : More than 47 μF. You must use the Low-impedance-type (low ESR) capacitor.

D<sub>1</sub> : Need for V<sub>O</sub> > V<sub>IN</sub>

D<sub>2</sub> : Need a shottky barrier diode for V<sub>O</sub> < GND.

RECOMMENDED OPERATING CONDITIONS

Parameter	Symbol	Type Number	MIN.	TYP.	MAX.	Unit
★ ★ Input Voltage	V <sub>IN</sub>	μPC2903	4.0		16	V
		μPC2933	4.3		16	
		μPC2905	6		16	
		μPC2906	7		16	
		μPC2907	8		16	
		μPC2908	9		18	
		μPC2909	10		18	
		μPC2910	11		18	
		μPC2912	13		18	
Output Current	I <sub>o</sub>	all	0		1.0	A
Operating Ambient Temperature	T <sub>A</sub>	all	-30		+85	°C
Operating Junction Temperature	T <sub>J</sub>	all	-30		+125	°C

ELECTRICAL CHARACTERISTICS μPC2903 (T<sub>J</sub> = 25 °C, V<sub>IN</sub> = 5 V, I<sub>o</sub> = 500 mA, C<sub>IN</sub> = 0.22 μF, C<sub>OUT</sub> = 47 μF, unless otherwise specified.)

Parameters	Symbol	Conditions	MIN.	TYP.	MAX.	Unit
Output Voltage	V <sub>o</sub>		2.88	3.0	3.12	V
		0 °C ≤ T <sub>J</sub> ≤ 125 °C, 4.0 V ≤ V <sub>IN</sub> ≤ 16 V, 0 A ≤ I <sub>o</sub> ≤ 500 mA	2.85		3.15	
		0 °C ≤ T <sub>J</sub> ≤ 125 °C, 0 A ≤ I <sub>o</sub> ≤ 1 A				
Line Regulation	REG <sub>IN</sub>	4.0 V ≤ V <sub>IN</sub> ≤ 16 V		11	30	mV
Load Regulation	REG <sub>L</sub>	0 A ≤ I <sub>o</sub> ≤ 1 A		9	30	mV
Quiescent Current	I <sub>BIAS</sub>	I <sub>o</sub> = 0 A		1.9	4.0	mA
		I <sub>o</sub> = 1 A		23	60	
Startup Quiescent Current	I <sub>BIAS (s)</sub>	V <sub>IN</sub> = 2.95 V, I <sub>o</sub> = 0 A		12	30	mA
		V <sub>IN</sub> = 2.95 V, I <sub>o</sub> = 1 A			80	
Quiescent Current Change	ΔI <sub>BIAS</sub>	0 °C ≤ T <sub>J</sub> ≤ 125 °C, 4.0 V ≤ V <sub>IN</sub> ≤ 16 V		3.2	20	mA
Output Noise Voltage	V <sub>n</sub>	10 Hz ≤ f ≤ 100 kHz		52		μV <sub>r.m.s.</sub>
Ripple Rejection	R·R	f = 120 Hz, 4.0 V ≤ V <sub>IN</sub> ≤ 16 V	48	63		dB
Dropout Voltage	V <sub>DIF</sub>	0 °C ≤ T <sub>J</sub> ≤ 125 °C, I <sub>o</sub> = 1 A		0.7	1.0	V
Short Circuit Current	I <sub>o short</sub>	V <sub>IN</sub> = 4.5 V	1.2	1.7	3.0	A
		V <sub>IN</sub> = 16 V		1.2		
Peak Output Current	I <sub>o peak</sub>	V <sub>IN</sub> = 4.5 V	1.0	1.5	3.0	A
		V <sub>IN</sub> = 16 V	1.3	1.7	2.8	
Temperature Coefficient of Output Voltage	ΔV <sub>o</sub> /ΔT	0 °C ≤ T <sub>J</sub> ≤ 125 °C, I <sub>o</sub> = 5 mA		-0.5		mV/°C

**ELECTRICAL CHARACTERISTICS  $\mu$ PC2933 ( $T_J = 25\text{ }^\circ\text{C}$ ,  $V_{IN} = 5\text{ V}$ ,  $I_o = 500\text{ mA}$ ,  $C_{IN} = 0.22\text{ }\mu\text{F}$ ,  $C_{OUT} = 47\text{ }\mu\text{F}$ , unless otherwise specified.)**

Parameters	Symbol	Conditions	MIN.	TYP.	MAX.	Unit
Output Voltage	$V_o$		3.17	3.3	3.43	V
		$0\text{ }^\circ\text{C} \leq T_J \leq 125\text{ }^\circ\text{C}$ , $4.3\text{ V} \leq V_{IN} \leq 16\text{ V}$ , $0\text{ A} \leq I_o \leq 500\text{ mA}$	3.14		3.46	
		$0\text{ }^\circ\text{C} \leq T_J \leq 125\text{ }^\circ\text{C}$ , $0\text{ A} \leq I_o \leq 1\text{ A}$				
Line Regulation	REG <sub>IN</sub>	$4.3\text{ V} \leq V_{IN} \leq 16\text{ V}$		12	33	mV
Load Regulation	REG <sub>L</sub>	$0\text{ A} \leq I_o \leq 1\text{ A}$		23	33	mV
Quiescent Current	$I_{BIAS}$	$I_o = 0\text{ A}$		2.0	4.0	mA
		$I_o = 1\text{ A}$		30	60	
Startup Quiescent Current	$I_{BIAS(s)}$	$V_{IN} = 3.1\text{ V}$ , $I_o = 0\text{ A}$		10	30	mA
		$V_{IN} = 3.1\text{ V}$ , $I_o = 1\text{ A}$			80	
Quiescent Current Change	$\Delta I_{BIAS}$	$0\text{ }^\circ\text{C} \leq T_J \leq 125\text{ }^\circ\text{C}$ , $4.3\text{ V} \leq V_{IN} \leq 16\text{ V}$		3.0	20	mA
Output Noise Voltage	$V_n$	$10\text{ Hz} \leq f \leq 100\text{ kHz}$		55		$\mu\text{V}_{r.m.s.}$
Ripple Rejection	R·R	$f = 120\text{ Hz}$ , $4.3\text{ V} \leq V_{IN} \leq 16\text{ V}$	48	64		dB
Dropout Voltage	$V_{DIF}$	$0\text{ }^\circ\text{C} \leq T_J \leq 125\text{ }^\circ\text{C}$ , $I_o = 1\text{ A}$		0.7	1.0	V
Short Circuit Current	$I_{O\text{ short}}$	$V_{IN} = 4.5\text{ V}$	1.2	1.6	3.0	A
		$V_{IN} = 16\text{ V}$		1.2		
Peak Output Current	$I_{O\text{ peak}}$	$V_{IN} = 4.5\text{ V}$	1.0	1.4	3.0	A
		$V_{IN} = 16\text{ V}$	1.3	1.7	2.8	
Temperature Coefficient of Output Voltage	$\Delta V_o/\Delta T$	$0\text{ }^\circ\text{C} \leq T_J \leq 125\text{ }^\circ\text{C}$ , $I_o = 5\text{ mA}$		-0.4		mV/ $^\circ\text{C}$

**ELECTRICAL CHARACTERISTICS** μPC2905 ( $T_J = 25\text{ }^\circ\text{C}$ ,  $V_{IN} = 8\text{ V}$ ,  $I_O = 500\text{ mA}$ ,  $C_{IN} = 0.22\text{ }\mu\text{F}$ ,  $C_{OUT} = 47\text{ }\mu\text{F}$ , unless otherwise specified.)

Parameters	Symbol	Conditions	MIN.	TYP.	MAX.	Unit
Output Voltage	$V_O$		4.8	5.0	5.2	V
		$0\text{ }^\circ\text{C} \leq T_J \leq 125\text{ }^\circ\text{C}$ , $6\text{ V} \leq V_{IN} \leq 16\text{ V}$ , $0\text{ A} \leq I_O \leq 500\text{ mA}$	4.75		5.25	
		$0\text{ }^\circ\text{C} \leq T_J \leq 125\text{ }^\circ\text{C}$ , $0\text{ A} \leq I_O \leq 1\text{ A}$				
Line Regulation	$REG_{IN}$	$6\text{ V} \leq V_{IN} \leq 16\text{ V}$		23	50	mV
Load Regulation	$REG_L$	$0\text{ A} \leq I_O \leq 1\text{ A}$		28	50	mV
Quiescent Current	$I_{BIAS}$	$I_O = 0\text{ A}$		2.2	4.0	mA
		$I_O = 1\text{ A}$		30	60	
Startup Quiescent Current	$I_{BIAS(s)}$	$V_{IN} = 4.5\text{ V}$ , $I_O = 0\text{ A}$		10	30	mA
		$V_{IN} = 4.5\text{ V}$ , $I_O = 1\text{ A}$			80	
Quiescent Current Change	$\Delta I_{BIAS}$	$0\text{ }^\circ\text{C} \leq T_J \leq 125\text{ }^\circ\text{C}$ , $6\text{ V} \leq V_{IN} \leq 16\text{ V}$		2.9	20	mA
Output Noise Voltage	$V_n$	$10\text{ Hz} \leq f \leq 100\text{ kHz}$		90		$\mu\text{V}_{r.m.s.}$
Ripple Rejection	R·R	$f = 120\text{ Hz}$ , $6\text{ V} \leq V_{IN} \leq 16\text{ V}$	46	61		dB
Dropout Voltage	$V_{DIF}$	$0\text{ }^\circ\text{C} \leq T_J \leq 125\text{ }^\circ\text{C}$ , $I_O = 1\text{ A}$		0.7	1.0	V
Short Circuit Current	$I_{O\text{ short}}$	$V_{IN} = 6.5\text{ V}$	1.15	1.8	3.0	A
		$V_{IN} = 16\text{ V}$		1.1		
Peak Output Current	$I_{O\text{ peak}}$	$V_{IN} = 6.5\text{ V}$	1.1	1.5	3.0	A
		$V_{IN} = 16\text{ V}$	1.4	2.0	2.8	
Temperature Coefficient of Output Voltage	$\Delta V_O/\Delta T$	$0\text{ }^\circ\text{C} \leq T_J \leq 125\text{ }^\circ\text{C}$ , $I_O = 5\text{ mA}$		0.6		$\text{mV}/^\circ\text{C}$

★ ELECTRICAL CHARACTERISTICS μPC2906 (T<sub>J</sub> = 25 °C, V<sub>IN</sub> = 9 V, I<sub>O</sub> = 500 mA, C<sub>IN</sub> = 0.22 μF, C<sub>OUT</sub> = 47 μF, unless otherwise specified.)

Parameters	Symbol	Conditions	MIN.	TYP.	MAX.	Unit
Output Voltage	V <sub>O</sub>		5.76	6.0	6.24	V
		0 °C ≤ T <sub>J</sub> ≤ 125 °C, 7 V ≤ V <sub>IN</sub> ≤ 16 V, 0 A ≤ I <sub>O</sub> ≤ 500 mA	5.70		6.30	
		0 °C ≤ T <sub>J</sub> ≤ 125 °C, 0 A ≤ I <sub>O</sub> ≤ 1 A				
Line Regulation	REG <sub>IN</sub>	7 V ≤ V <sub>IN</sub> ≤ 16 V		25	60	mV
Load Regulation	REG <sub>L</sub>	0 A ≤ I <sub>O</sub> ≤ 1 A		29	60	mV
Quiescent Current	I <sub>BIAS</sub>	I <sub>O</sub> = 0 A		2.0	4.0	mA
		I <sub>O</sub> = 1 A		23	60	
Startup Quiescent Current	I <sub>BIAS (s)</sub>	V <sub>IN</sub> = 5.5 V, I <sub>O</sub> = 0 A		10	30	mA
		V <sub>IN</sub> = 5.5 V, I <sub>O</sub> = 1 A			80	
Quiescent Current Change	ΔI <sub>BIAS</sub>	0 °C ≤ T <sub>J</sub> ≤ 125 °C, 7 V ≤ V <sub>IN</sub> ≤ 16 V		2.2	20	mA
Output Noise Voltage	V <sub>n</sub>	10 Hz ≤ f ≤ 100 kHz		108		μV <sub>r.m.s.</sub>
Ripple Rejection	R·R	f = 120 Hz, 7 V ≤ V <sub>IN</sub> ≤ 16 V	44	60		dB
Dropout Voltage	V <sub>DIF</sub>	0 °C ≤ T <sub>J</sub> ≤ 125 °C, I <sub>O</sub> = 1 A		0.7	1.0	V
Short Circuit Current	I <sub>O short</sub>	V <sub>IN</sub> = 7.5 V		1.8		A
		V <sub>IN</sub> = 16 V		1.1		
Peak Output Current	I <sub>O peak</sub>	V <sub>IN</sub> = 7.5 V	1.1	1.5	3.0	A
		V <sub>IN</sub> = 16 V	1.4	2.0	2.8	
Temperature Coefficient of Output Voltage	ΔV <sub>O</sub> /ΔT	0 °C ≤ T <sub>J</sub> ≤ 125 °C, I <sub>O</sub> = 5 mA		0.6		mV/°C

★ ELECTRICAL CHARACTERISTICS μPC2907 (T<sub>J</sub> = 25 °C, V<sub>IN</sub> = 10 V, I<sub>O</sub> = 500 mA, C<sub>IN</sub> = 0.22 μF, C<sub>OUT</sub> = 47 μF, unless otherwise specified.)

Parameters	Symbol	Conditions	MIN.	TYP.	MAX.	Unit
Output Voltage	V <sub>O</sub>		6.72	7.0	7.28	V
		0 °C ≤ T <sub>J</sub> ≤ 125 °C, 8 V ≤ V <sub>IN</sub> ≤ 16 V, 0 A ≤ I <sub>O</sub> ≤ 500 mA	6.65		7.35	
		0 °C ≤ T <sub>J</sub> ≤ 125 °C, 0 A ≤ I <sub>O</sub> ≤ 1 A				
Line Regulation	REG <sub>IN</sub>	8 V ≤ V <sub>IN</sub> ≤ 16 V		27	70	mV
Load Regulation	REG <sub>L</sub>	0 A ≤ I <sub>O</sub> ≤ 1 A		30	70	mV
Quiescent Current	I <sub>BIAS</sub>	I <sub>O</sub> = 0 A		2.0	4.0	mA
		I <sub>O</sub> = 1 A		24	60	
Startup Quiescent Current	I <sub>BIAS (s)</sub>	V <sub>IN</sub> = 6.5 V, I <sub>O</sub> = 0 A		10	30	mA
		V <sub>IN</sub> = 6.5 V, I <sub>O</sub> = 1 A			80	
Quiescent Current Change	ΔI <sub>BIAS</sub>	0 °C ≤ T <sub>J</sub> ≤ 125 °C, 8 V ≤ V <sub>IN</sub> ≤ 16 V		2.3	20	mA
Output Noise Voltage	V <sub>n</sub>	10 Hz ≤ f ≤ 100 kHz		126		μV <sub>r.m.s.</sub>
Ripple Rejection	R·R	f = 120 Hz, 8 V ≤ V <sub>IN</sub> ≤ 16 V	43	59		dB
Dropout Voltage	V <sub>DIF</sub>	0 °C ≤ T <sub>J</sub> ≤ 125 °C, I <sub>O</sub> = 1 A		0.7	1.0	V
Short Circuit Current	I <sub>O short</sub>	V <sub>IN</sub> = 8.5 V		1.8		A
		V <sub>IN</sub> = 16 V		1.1		
Peak Output Current	I <sub>O peak</sub>	V <sub>IN</sub> = 8.5 V	1.1	1.5	3.0	A
		V <sub>IN</sub> = 16 V	1.4	2.0	2.8	
Temperature Coefficient of Output Voltage	ΔV <sub>O</sub> /ΔT	0 °C ≤ T <sub>J</sub> ≤ 125 °C, I <sub>O</sub> = 5 mA		0.6		mV/°C



**ELECTRICAL CHARACTERISTICS  $\mu$ PC2908 ( $T_J = 25\text{ }^\circ\text{C}$ ,  $V_{IN} = 11\text{ V}$ ,  $I_O = 500\text{ mA}$ ,  $C_{IN} = 0.22\text{ }\mu\text{F}$ ,  $C_{OUT} = 47\text{ }\mu\text{F}$ , unless otherwise specified.)**

Parameters	Symbol	Conditions	MIN.	TYP.	MAX.	Unit
Output Voltage	$V_O$		7.68	8.0	8.32	V
		$0\text{ }^\circ\text{C} \leq T_J \leq 125\text{ }^\circ\text{C}$ , $9\text{ V} \leq V_{IN} \leq 18\text{ V}$ , $0\text{ A} \leq I_O \leq 500\text{ mA}$	7.6		8.4	
		$0\text{ }^\circ\text{C} \leq T_J \leq 125\text{ }^\circ\text{C}$ , $0\text{ A} \leq I_O \leq 1\text{ A}$				
Line Regulation	REG <sub>IN</sub>	$9\text{ V} \leq V_{IN} \leq 18\text{ V}$		31	80	mV
Load Regulation	REG <sub>L</sub>	$0\text{ A} \leq I_O \leq 1\text{ A}$		30	80	mV
Quiescent Current	$I_{BIAS}$	$I_O = 0\text{ A}$		1.9	4.0	mA
		$I_O = 1\text{ A}$		25	60	
Startup Quiescent Current	$I_{BIAS(s)}$	$V_{IN} = 7.5\text{ V}$ , $I_O = 0\text{ A}$		10	30	mA
		$V_{IN} = 7.5\text{ V}$ , $I_O = 1\text{ A}$			80	
Quiescent Current Change	$\Delta I_{BIAS}$	$0\text{ }^\circ\text{C} \leq T_J \leq 125\text{ }^\circ\text{C}$ , $9\text{ V} \leq V_{IN} \leq 18\text{ V}$		2.4	20	mA
Output Noise Voltage	$V_n$	$10\text{ Hz} \leq f \leq 100\text{ kHz}$		145		$\mu\text{V}_{r.m.s.}$
Ripple Rejection	R·R	$f = 120\text{ Hz}$ , $9\text{ V} \leq V_{IN} \leq 18\text{ V}$	42	58		dB
Dropout Voltage	$V_{DIF}$	$0\text{ }^\circ\text{C} \leq T_J \leq 125\text{ }^\circ\text{C}$ , $I_O = 1\text{ A}$		0.7	1.0	V
Short Circuit Current	$I_{O\text{ short}}$	$V_{IN} = 9.5\text{ V}$		1.9		A
		$V_{IN} = 18\text{ V}$		1.0		
Peak Output Current	$I_{O\text{ peak}}$	$V_{IN} = 9.5\text{ V}$	1.1	1.5	3.0	A
		$V_{IN} = 18\text{ V}$	1.4	2.0	2.8	
Temperature Coefficient of Output Voltage	$\Delta V_O/\Delta T$	$0\text{ }^\circ\text{C} \leq T_J \leq 125\text{ }^\circ\text{C}$ , $I_O = 5\text{ mA}$		0.6		mV/ $^\circ\text{C}$

**ELECTRICAL CHARACTERISTICS μPC2909 (T<sub>J</sub> = 25 °C, V<sub>IN</sub> = 12 V, I<sub>O</sub> = 500 mA, C<sub>IN</sub> = 0.22 μF, C<sub>OUT</sub> = 47 μF, unless otherwise specified.)**

Parameters	Symbol	Conditions	MIN.	TYP.	MAX.	Unit
Output Voltage	V <sub>O</sub>		8.64	9.0	9.36	V
		0 °C ≤ T <sub>J</sub> ≤ 125 °C, 10 V ≤ V <sub>IN</sub> ≤ 18 V, 0 A ≤ I <sub>O</sub> ≤ 500 mA	8.55		9.45	
		0 °C ≤ T <sub>J</sub> ≤ 125 °C, 0 A ≤ I <sub>O</sub> ≤ 1 A				
Line Regulation	REG <sub>IN</sub>	10 V ≤ V <sub>IN</sub> ≤ 18 V		31	90	mV
Load Regulation	REG <sub>L</sub>	0 A ≤ I <sub>O</sub> ≤ 1 A		32	90	mV
Quiescent Current	I <sub>BIAS</sub>	I <sub>O</sub> = 0 A		1.9	4.0	mA
		I <sub>O</sub> = 1 A		27	60	
Startup Quiescent Current	I <sub>BIAS (s)</sub>	V <sub>IN</sub> = 8.5 V, I <sub>O</sub> = 0 A		11	30	mA
		V <sub>IN</sub> = 8.5 V, I <sub>O</sub> = 1 A			80	
Quiescent Current Change	ΔI <sub>BIAS</sub>	0 °C ≤ T <sub>J</sub> ≤ 125 °C, 10 V ≤ V <sub>IN</sub> ≤ 18 V		3.0	20	mA
Output Noise Voltage	V <sub>n</sub>	10 Hz ≤ f ≤ 100 kHz		155		μV <sub>r.m.s.</sub>
Ripple Rejection	R·R	f = 120 Hz, 10 V ≤ V <sub>IN</sub> ≤ 18 V	41	58		dB
Dropout Voltage	V <sub>DIF</sub>	0 °C ≤ T <sub>J</sub> ≤ 125 °C, I <sub>O</sub> = 1 A		0.7	1.0	V
Short Circuit Current	I <sub>O short</sub>	V <sub>IN</sub> = 10.5 V		1.9		A
		V <sub>IN</sub> = 18 V		1.0		
Peak Output Current	I <sub>O peak</sub>	V <sub>IN</sub> = 10.5 V	1.1	1.5	3.0	A
		V <sub>IN</sub> = 18 V	1.4	2.0	3.0	
Temperature Coefficient of Output Voltage	ΔV <sub>O</sub> /ΔT	0 °C ≤ T <sub>J</sub> ≤ 125 °C, I <sub>O</sub> = 5 mA		1.0		mV/°C

**ELECTRICAL CHARACTERISTICS  $\mu$ PC2910 ( $T_J = 25\text{ }^\circ\text{C}$ ,  $V_{IN} = 13\text{ V}$ ,  $I_o = 500\text{ mA}$ ,  $C_{IN} = 0.22\text{ }\mu\text{F}$ ,  $C_{OUT} = 47\text{ }\mu\text{F}$ , unless otherwise specified.)**

Parameters	Symbol	Conditions	MIN.	TYP.	MAX.	Unit
Output Voltage	$V_o$		9.6	10.0	10.4	V
		$0\text{ }^\circ\text{C} \leq T_J \leq 125\text{ }^\circ\text{C}$ , $11\text{ V} \leq V_{IN} \leq 18\text{ V}$ , $0\text{ A} \leq I_o \leq 500\text{ mA}$	9.5		10.5	
		$0\text{ }^\circ\text{C} \leq T_J \leq 125\text{ }^\circ\text{C}$ , $0\text{ A} \leq I_o \leq 1\text{ A}$				
Line Regulation	REG <sub>IN</sub>	$11\text{ V} \leq V_{IN} \leq 18\text{ V}$		35	100	mV
Load Regulation	REG <sub>L</sub>	$0\text{ A} \leq I_o \leq 1\text{ A}$		33	100	mV
Quiescent Current	$I_{BIAS}$	$I_o = 0\text{ A}$		2.0	4.0	mA
		$I_o = 1\text{ A}$		25	60	
Startup Quiescent Current	$I_{BIAS(s)}$	$V_{IN} = 9.5\text{ V}$ , $I_o = 0\text{ A}$		10	30	mA
		$V_{IN} = 9.5\text{ V}$ , $I_o = 1\text{ A}$			80	
Quiescent Current Change	$\Delta I_{BIAS}$	$0\text{ }^\circ\text{C} \leq T_J \leq 125\text{ }^\circ\text{C}$ , $11\text{ V} \leq V_{IN} \leq 18\text{ V}$		1.9	20	mA
Output Noise Voltage	$V_n$	$10\text{ Hz} \leq f \leq 100\text{ kHz}$		180		$\mu\text{V}_{r.m.s.}$
Ripple Rejection	R·R	$f = 120\text{ Hz}$ , $11\text{ V} \leq V_{IN} \leq 18\text{ V}$	40	56		dB
Dropout Voltage	$V_{DIF}$	$0\text{ }^\circ\text{C} \leq T_J \leq 125\text{ }^\circ\text{C}$ , $I_o = 1\text{ A}$		0.7	1.0	V
Short Circuit Current	$I_{O\text{ short}}$	$V_{IN} = 11.5\text{ V}$		1.7		A
		$V_{IN} = 18\text{ V}$		1.0		
Peak Output Current	$I_{O\text{ peak}}$	$V_{IN} = 11.5\text{ V}$	1.1	1.6	3.0	A
		$V_{IN} = 18\text{ V}$	1.4	2.0	3.0	
Temperature Coefficient of Output Voltage	$\Delta V_o/\Delta T$	$0\text{ }^\circ\text{C} \leq T_J \leq 125\text{ }^\circ\text{C}$ , $I_o = 5\text{ mA}$		2.1		mV/°C

**ELECTRICAL CHARACTERISTICS** μPC2912 ( $T_J = 25\text{ }^\circ\text{C}$ ,  $V_{IN} = 15\text{ V}$ ,  $I_O = 500\text{ mA}$ ,  $C_{IN} = 0.22\text{ }\mu\text{F}$ ,  $C_{OUT} = 47\text{ }\mu\text{F}$ , unless otherwise specified.)

Parameters	Symbol	Conditions	MIN.	TYP.	MAX.	Unit
Output Voltage	$V_O$		11.52	12	12.48	V
		$0\text{ }^\circ\text{C} \leq T_J \leq 125\text{ }^\circ\text{C}$ , $13\text{ V} \leq V_{IN} \leq 18\text{ V}$ , $0\text{ A} \leq I_O \leq 500\text{ mA}$	11.4		12.6	
		$0\text{ }^\circ\text{C} \leq T_J \leq 125\text{ }^\circ\text{C}$ , $0\text{ A} \leq I_O \leq 1\text{ A}$				
Line Regulation	$REG_{IN}$	$13\text{ V} \leq V_{IN} \leq 18\text{ V}$		38	120	mV
Load Regulation	$REG_L$	$0\text{ A} \leq I_O \leq 1\text{ A}$		35	120	mV
Quiescent Current	$I_{BIAS}$	$I_O = 0\text{ A}$		2.1	4.0	mA
		$I_O = 1\text{ A}$		26	60	
Startup Quiescent Current	$I_{BIAS(s)}$	$V_{IN} = 11.5\text{ V}$ , $I_O = 0\text{ A}$		10	30	mA
		$V_{IN} = 11.5\text{ V}$ , $I_O = 1\text{ A}$			80	
Quiescent Current Change	$\Delta I_{BIAS}$	$0\text{ }^\circ\text{C} \leq T_J \leq 125\text{ }^\circ\text{C}$ , $13\text{ V} \leq V_{IN} \leq 18\text{ V}$		1.5	20	mA
Output Noise Voltage	$V_n$	$10\text{ Hz} \leq f \leq 100\text{ kHz}$		210		$\mu\text{V}_{r.m.s.}$
Ripple Rejection	R·R	$f = 120\text{ Hz}$ , $13\text{ V} \leq V_{IN} \leq 18\text{ V}$	40	52		dB
Dropout Voltage	$V_{DIF}$	$0\text{ }^\circ\text{C} \leq T_J \leq 125\text{ }^\circ\text{C}$ , $I_O = 1\text{ A}$		0.7	1.0	V
Short Circuit Current	$I_{O\text{ short}}$	$V_{IN} = 14\text{ V}$		1.7		A
		$V_{IN} = 18\text{ V}$		1.0		
Peak Output Current	$I_{O\text{ peak}}$	$V_{IN} = 14\text{ V}$	1.1	1.6	3.0	A
		$V_{IN} = 18\text{ V}$	1.4	2.0	3.0	
Temperature Coefficient of Output Voltage	$\Delta V_O/\Delta T$	$0\text{ }^\circ\text{C} \leq T_J \leq 125\text{ }^\circ\text{C}$ , $I_O = 5\text{ mA}$		2.1		mV/°C

TYPICAL CHARACTERISTICS

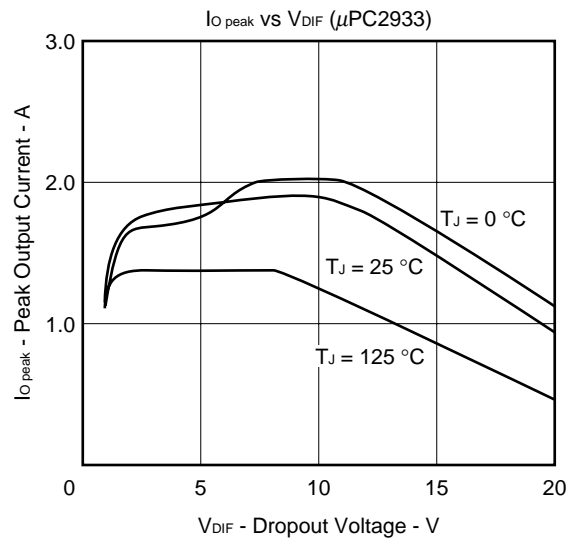
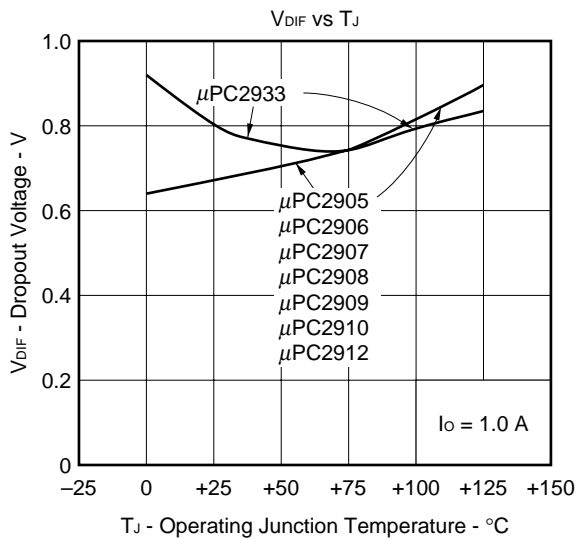
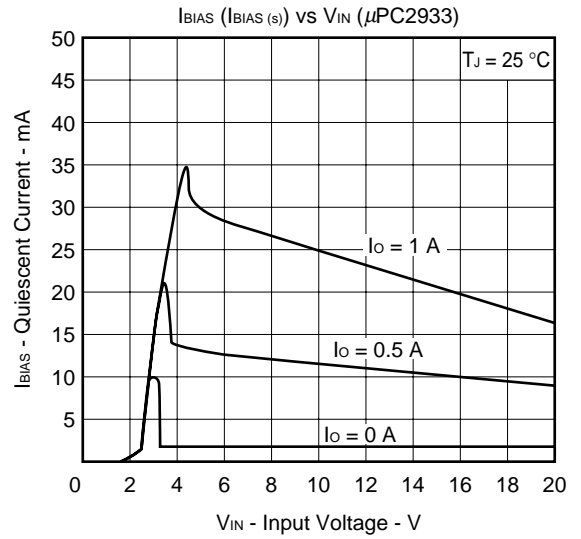
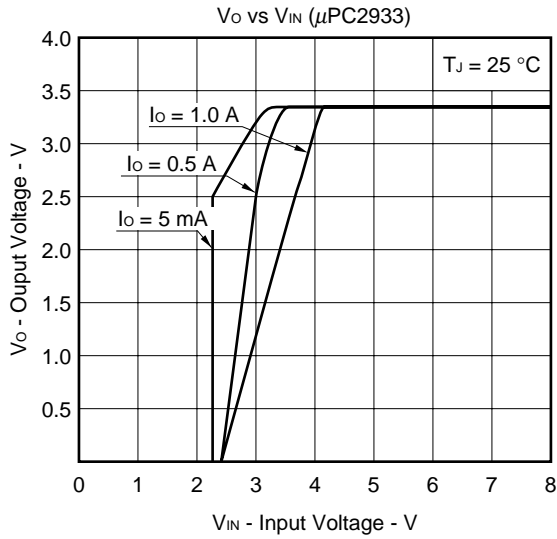
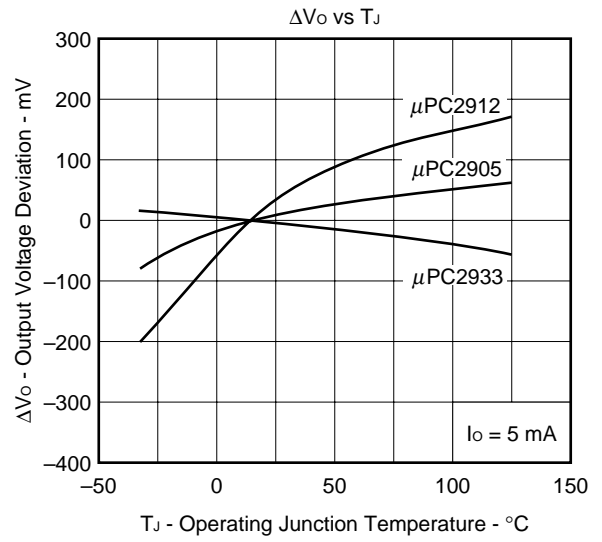
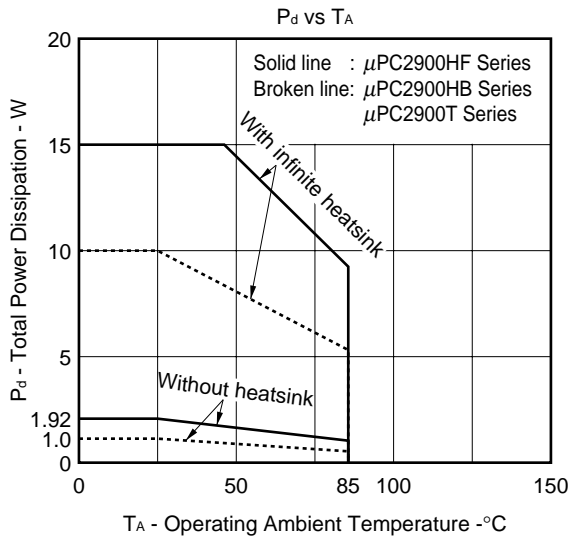

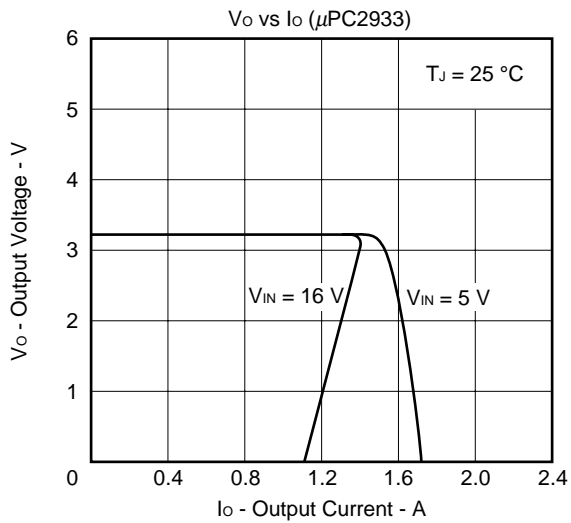
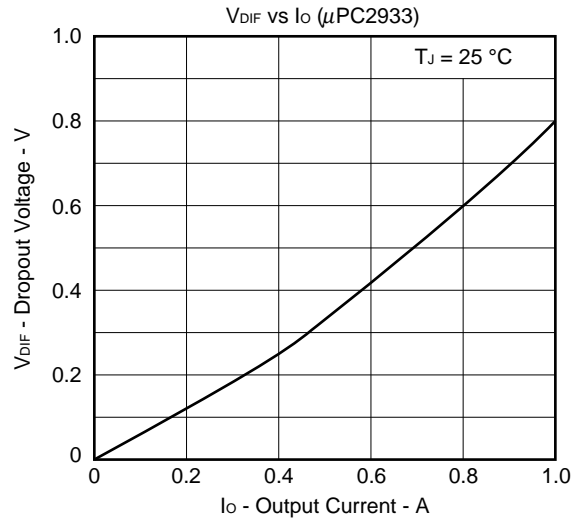
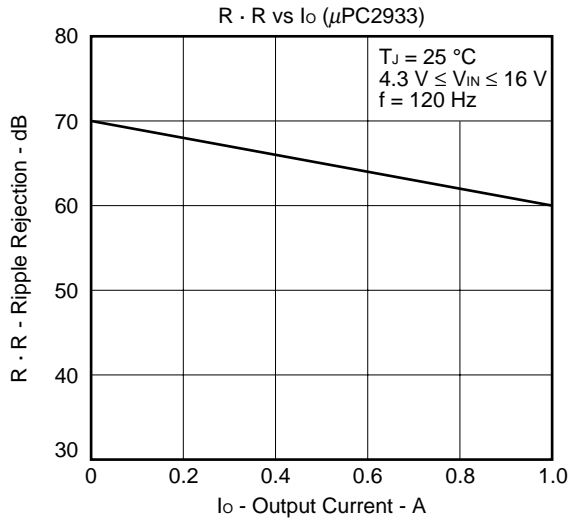
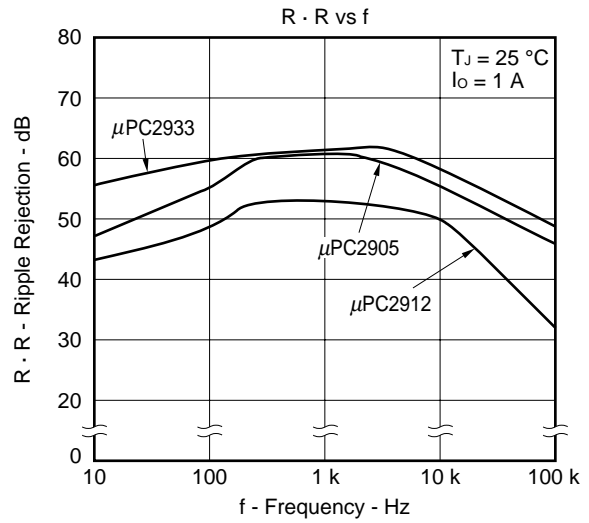
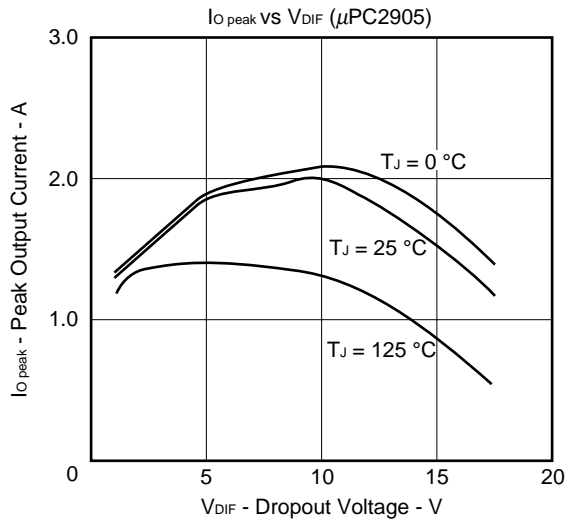

PACKAGE DRAWINGS

μPC2900HF Series

3PIN PLASTIC SIP (MP-45G)

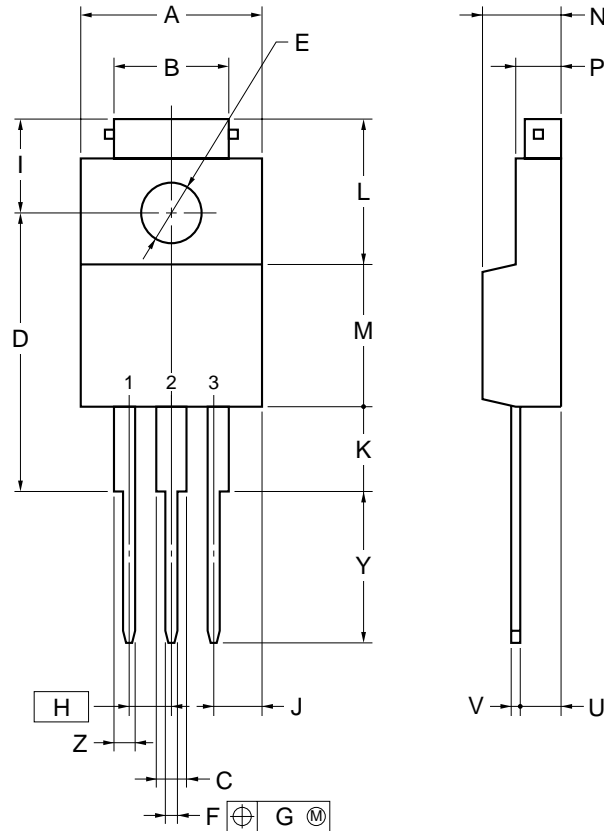

NOTE

Each lead centerline is located within 0.25 mm of its true position (T.P.) at maximum material condition.

ITEM	MILLIMETERS
A	10.0±0.2
B	7.0±0.2
C	1.50±0.2
D	17.0±0.3
E	φ3.3±0.2
F	0.75±0.10
G	0.25
H	2.54 (T.P.)
I	5.0±0.3
J	2.46±0.2
K	5.0±0.2
L	8.5±0.2
M	8.5±0.2
N	4.5±0.2
P	2.8±0.2
U	2.4±0.5
V	0.65±0.10
Y	8.9±0.7
Z	1.30±0.2

P3HF-254B-4

μPC2900HB Series

MP-3 (SC-64) (Unit: mm)

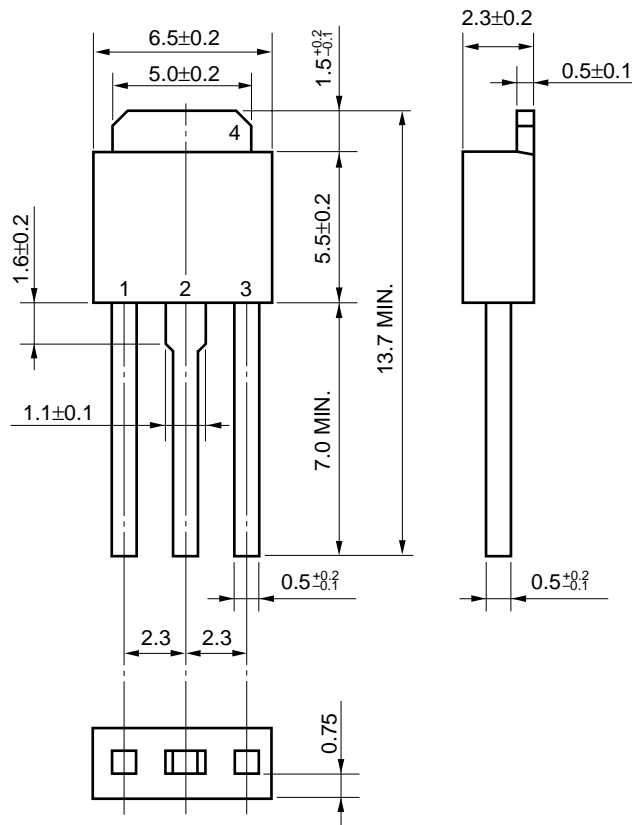

μPC2900T Series

MP-3Z (SC-63) (Unit: mm)

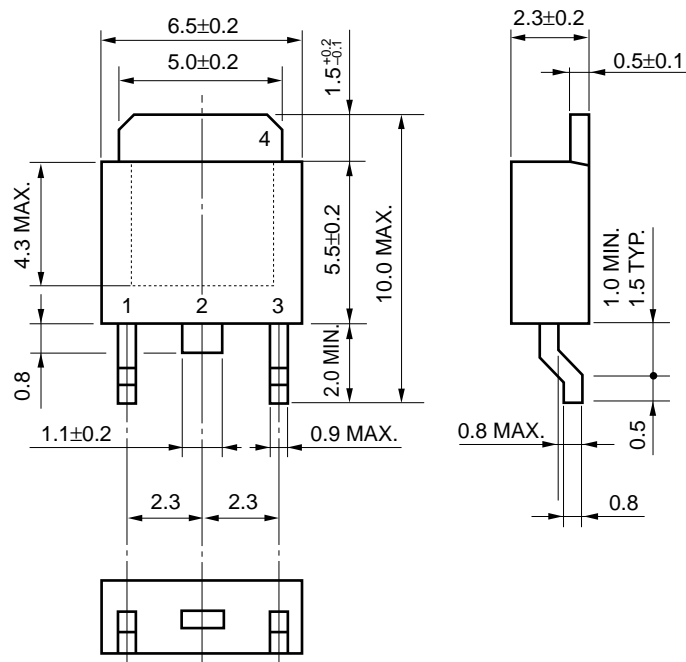



**RECOMMENDED SOLDERING CONDITIONS**

When soldering this product, it is highly recommended to observe the conditions as shown below. If other soldering processes are used, or if the soldering is performed under different condition, please make sure to consult with our sales offices.

For more details, refer to our document “**SEMICONDUCTOR DEVICE MOUNTING TECHNOLOGY MANUAL**” (C10535E).

**Surface mount devices**

**μPC2900T Series: MP-3Z**

Process	Conditions	Symbol
Infrared ray reflow	Peak temperature: 235 °C or below (Package surface temperature), Reflow time: 30 seconds or less (at 210 °C or higher), Maximum number of reflow processes: 2 times.	IR35-00-2
VPS	Peak temperature: 215 °C or below (Package surface temperature), Reflow time: 40 seconds or less (at 200 °C or higher), Maximum number of reflow processes: 2 times.	VP15-00-2
Wave soldering	Solder temperature: 260 °C or below, Flow time: 10 seconds or less, Maximum number of flow processes: 1 time, Pre-heating temperature: 120 °C or below (Package surface temperature).	WS60-00-1
★ Partial heating method	Pin temperature: 300 °C or below, Heat time: 3 seconds or less (Per each side of the device).	—

**Caution** Apply only one kind of soldering condition to a device, except for “partial heating method”, or the device will be damaged by heat stress.

**Through-hole devices**

**μPC2900HF Series: MP-45G**

**μPC2900HB Series: MP-3**

Process	Conditions
Wave soldering (only to leads)	Solder temperature: 260 °C or below, Flow time: 10 seconds or less.
★ Partial heating method	Pin temperature: 300 °C or below, Heat time: 3 seconds or less (Per each pin).

**Caution** For through-hole device, the wave soldering process must be applied only to leads, and make sure that the package body does not get jet soldered.

**CAUTION ON USE**

When using the  $\mu$ PC2900 series at the input voltage which is lower than in the recommended operating condition, the big quiescent current flows through devices because the transistor of the output paragraph is saturated (Refer to  $I_{BIAS}$  ( $I_{BIAS(s)}$ ) vs  $V_{IN}$  curves in **TYPICAL CHARACTERISTICS**). The  $\mu$ PC2900 series have saturation protection circuits, but they sometimes need about 80 mA current. Therefore the power supply on the input needs the enough current capacity to pass this quiescent current when the devices startup.

**REFERENCE DOCUMENTS**

★ QUALITY GRADE ON NEC SEMICONDUCTOR DEVICES	C11531E
SEMICONDUCTOR DEVICE MOUNTING TECHNOLOGY MANUAL	C10535E
IC PACKAGE MANUAL	C10943X
GUIDE TO QUALITY ASSUARANCE FOR SEMICONDUCTOR DEVICES	MEI-1202
SEMICONDUCTORS SELECTION GUIDE	X10679E
NEC SEMICONDUCTOR DEVICE RELIABILITY/QUALITY CONTROL	IEI-1212
SYSTEM-THREE TERMINAL REGULATOR	

[MEMO]

[MEMO]

No part of this document may be copied or reproduced in any form or by any means without the prior written consent of NEC Corporation. NEC Corporation assumes no responsibility for any errors which may appear in this document.

NEC Corporation does not assume any liability for infringement of patents, copyrights or other intellectual property rights of third parties by or arising from use of a device described herein or any other liability arising from use of such device. No license, either express, implied or otherwise, is granted under any patents, copyrights or other intellectual property rights of NEC Corporation or others.

While NEC Corporation has been making continuous effort to enhance the reliability of its semiconductor devices, the possibility of defects cannot be eliminated entirely. To minimize risks of damage or injury to persons or property arising from a defect in an NEC semiconductor device, customers must incorporate sufficient safety measures in its design, such as redundancy, fire-containment, and anti-failure features.

NEC devices are classified into the following three quality grades:

"Standard", "Special", and "Specific". The Specific quality grade applies only to devices developed based on a customer designated "quality assurance program" for a specific application. The recommended applications of a device depend on its quality grade, as indicated below. Customers must check the quality grade of each device before using it in a particular application.

Standard: Computers, office equipment, communications equipment, test and measurement equipment, audio and visual equipment, home electronic appliances, machine tools, personal electronic equipment and industrial robots

Special: Transportation equipment (automobiles, trains, ships, etc.), traffic control systems, anti-disaster systems, anti-crime systems, safety equipment and medical equipment (not specifically designed for life support)

Specific: Aircrafts, aerospace equipment, submersible repeaters, nuclear reactor control systems, life support systems or medical equipment for life support, etc.

The quality grade of NEC devices is "Standard" unless otherwise specified in NEC's Data Sheets or Data Books. If customers intend to use NEC devices for applications other than those specified for Standard quality grade, they should contact an NEC sales representative in advance.

Anti-radioactive design is not implemented in this product.