

To our customers,

Old Company Name in Catalogs and Other Documents

On April 1st, 2010, NEC Electronics Corporation merged with Renesas Technology Corporation, and Renesas Electronics Corporation took over all the business of both companies. Therefore, although the old company name remains in this document, it is a valid Renesas Electronics document. We appreciate your understanding.

Renesas Electronics website: <http://www.renesas.com>

April 1st, 2010
Renesas Electronics Corporation

Issued by: Renesas Electronics Corporation (<http://www.renesas.com>)

Send any inquiries to <http://www.renesas.com/inquiry>.

Notice

1. All information included in this document is current as of the date this document is issued. Such information, however, is subject to change without any prior notice. Before purchasing or using any Renesas Electronics products listed herein, please confirm the latest product information with a Renesas Electronics sales office. Also, please pay regular and careful attention to additional and different information to be disclosed by Renesas Electronics such as that disclosed through our website.
2. Renesas Electronics does not assume any liability for infringement of patents, copyrights, or other intellectual property rights of third parties by or arising from the use of Renesas Electronics products or technical information described in this document. No license, express, implied or otherwise, is granted hereby under any patents, copyrights or other intellectual property rights of Renesas Electronics or others.
3. You should not alter, modify, copy, or otherwise misappropriate any Renesas Electronics product, whether in whole or in part.
4. Descriptions of circuits, software and other related information in this document are provided only to illustrate the operation of semiconductor products and application examples. You are fully responsible for the incorporation of these circuits, software, and information in the design of your equipment. Renesas Electronics assumes no responsibility for any losses incurred by you or third parties arising from the use of these circuits, software, or information.
5. When exporting the products or technology described in this document, you should comply with the applicable export control laws and regulations and follow the procedures required by such laws and regulations. You should not use Renesas Electronics products or the technology described in this document for any purpose relating to military applications or use by the military, including but not limited to the development of weapons of mass destruction. Renesas Electronics products and technology may not be used for or incorporated into any products or systems whose manufacture, use, or sale is prohibited under any applicable domestic or foreign laws or regulations.
6. Renesas Electronics has used reasonable care in preparing the information included in this document, but Renesas Electronics does not warrant that such information is error free. Renesas Electronics assumes no liability whatsoever for any damages incurred by you resulting from errors in or omissions from the information included herein.
7. Renesas Electronics products are classified according to the following three quality grades: “Standard”, “High Quality”, and “Specific”. The recommended applications for each Renesas Electronics product depends on the product’s quality grade, as indicated below. You must check the quality grade of each Renesas Electronics product before using it in a particular application. You may not use any Renesas Electronics product for any application categorized as “Specific” without the prior written consent of Renesas Electronics. Further, you may not use any Renesas Electronics product for any application for which it is not intended without the prior written consent of Renesas Electronics. Renesas Electronics shall not be in any way liable for any damages or losses incurred by you or third parties arising from the use of any Renesas Electronics product for an application categorized as “Specific” or for which the product is not intended where you have failed to obtain the prior written consent of Renesas Electronics. The quality grade of each Renesas Electronics product is “Standard” unless otherwise expressly specified in a Renesas Electronics data sheets or data books, etc.
 - “Standard”: Computers; office equipment; communications equipment; test and measurement equipment; audio and visual equipment; home electronic appliances; machine tools; personal electronic equipment; and industrial robots.
 - “High Quality”: Transportation equipment (automobiles, trains, ships, etc.); traffic control systems; anti-disaster systems; anti-crime systems; safety equipment; and medical equipment not specifically designed for life support.
 - “Specific”: Aircraft; aerospace equipment; submersible repeaters; nuclear reactor control systems; medical equipment or systems for life support (e.g. artificial life support devices or systems), surgical implantations, or healthcare intervention (e.g. excision, etc.), and any other applications or purposes that pose a direct threat to human life.
8. You should use the Renesas Electronics products described in this document within the range specified by Renesas Electronics, especially with respect to the maximum rating, operating supply voltage range, movement power voltage range, heat radiation characteristics, installation and other product characteristics. Renesas Electronics shall have no liability for malfunctions or damages arising out of the use of Renesas Electronics products beyond such specified ranges.
9. Although Renesas Electronics endeavors to improve the quality and reliability of its products, semiconductor products have specific characteristics such as the occurrence of failure at a certain rate and malfunctions under certain use conditions. Further, Renesas Electronics products are not subject to radiation resistance design. Please be sure to implement safety measures to guard them against the possibility of physical injury, and injury or damage caused by fire in the event of the failure of a Renesas Electronics product, such as safety design for hardware and software including but not limited to redundancy, fire control and malfunction prevention, appropriate treatment for aging degradation or any other appropriate measures. Because the evaluation of microcomputer software alone is very difficult, please evaluate the safety of the final products or system manufactured by you.
10. Please contact a Renesas Electronics sales office for details as to environmental matters such as the environmental compatibility of each Renesas Electronics product. Please use Renesas Electronics products in compliance with all applicable laws and regulations that regulate the inclusion or use of controlled substances, including without limitation, the EU RoHS Directive. Renesas Electronics assumes no liability for damages or losses occurring as a result of your noncompliance with applicable laws and regulations.
11. This document may not be reproduced or duplicated, in any form, in whole or in part, without prior written consent of Renesas Electronics.
12. Please contact a Renesas Electronics sales office if you have any questions regarding the information contained in this document or Renesas Electronics products, or if you have any other inquiries.

(Note 1) “Renesas Electronics” as used in this document means Renesas Electronics Corporation and also includes its majority-owned subsidiaries.

(Note 2) “Renesas Electronics product(s)” means any product developed or manufactured by or for Renesas Electronics.

THREE TERMINAL POSITIVE VOLTAGE REGULATORS

DESCRIPTION

The μPC78L00 series are monolithic three terminal positive regulators which employ internally current limiting, thermal shut down, output transistor safe area protection make them essentially indestructible.

They are intended as fixed voltage regulators in a wide range of application including local on card regulation for elimination of distribution problems associated wide single point regulation.

FEATURES

- Output current in excess of 100 mA.
- Low noise.
- High Ripple Rejection.
- Internal output transistor safe area protection.
- Internal thermal overload protection.
- Internal short circuit current limiting.

ORDER INFORMATION

Type Number	Output Voltage	Package	Quality Grade
μPC78L05J	5 V	TO-92	Standard
μPC78L05T		SOT-89	
μPC78L06J	6 V	TO-92	
μPC78L06T		SOT-89	
μPC78L07J	7 V	TO-92	
μPC78L07T		SOT-89	
μPC78L08J	8 V	TO-92	
μPC78L08T		SOT-89	
μPC78L10J	10 V	TO-92	
μPC78L10T		SOT-89	
μPC78L12J	12 V	TO-92	
μPC78L12T		SOT-89	
μPC78L15J	15 V	TO-92	
μPC78L15T		SOT-89	

CONNECTION DIAGRAM

μPC78L00J Series

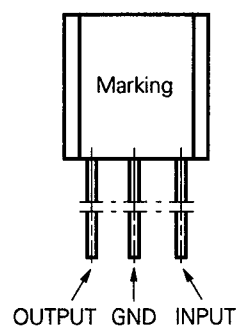

μPC78L00T Series

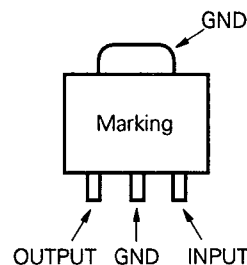

Please refer to "Quality grade on NEC Semiconductor Devices" (Document number IEI-1209) published by NEC Corporation to know the specification of quality grade on the devices and its recommended applications.

EQUIVALENT CIRCUIT

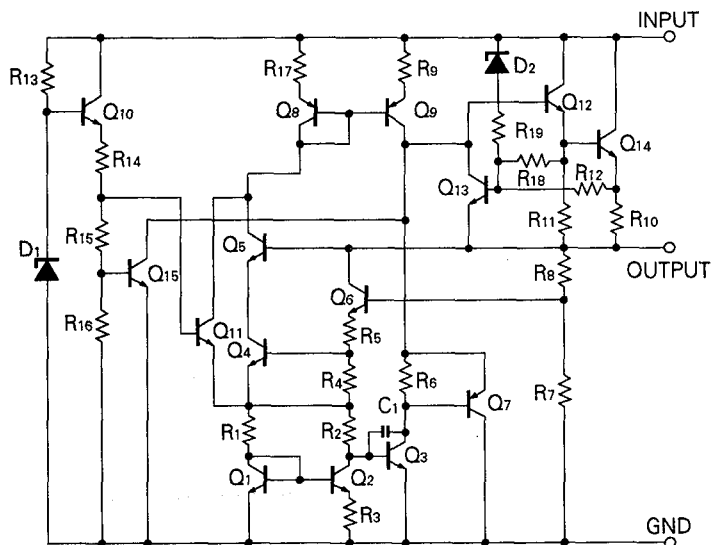

ABSOLUTE MAXIMUM RATINGS (T_a = 25 °C)

PARAMETER	SYMBOL	RATINGS		UNIT
		μPC78L00J Series	μPC78L00T Series	
Input Voltage	V _{IN}	30/35 (Note1)		V
Internal Power Dissipation	P _T	700	400/2000 (Note2)	mW
Operating Ambient Temperature Range	T _{opt}	-20 to +85		°C
Operating Junction Temperature Range	T _{opt (j)}	-20 to +150		°C
Storage Temperature Range	T _{stg}	-55 to +150		°C
Thermal Resistance (junction to ambient)	R _{th (j-a)}	180	315/62.5 (Note2)	°C/W

(Note 1) μPC78L05, 06, 07, 08 : 30 V, μPC78L10, 12, 15 : 35 V

(Note 2) with 2.5 cm² × 0.7 mm ceramic substrate

TYPICAL CONNECTION

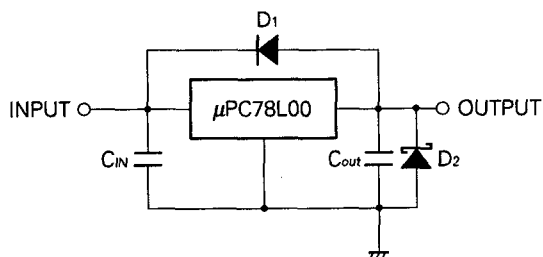

C₁: Required if regulator is located an appreciable distance from power supply filter

C₂: More than 0.1 μF

D₁: Needed for V_{IN} < V_o

D₂: Needed for V_o < GND

RECOMMENDED OPERATING CONDITIONS

CHARACTERISTIC	SYMBOL	TYPE NUMBER	MIN.	TYP.	MAX.	UNIT
Input Voltage	V_{IN}	μ PC78L05	7	10	20	V
		μ PC78L06	8.5	11	21	
		μ PC78L07	9.5	12	22	
		μ PC78L08	10.5	14	23	
		μ PC78L10	12.5	17	25	
		μ PC78L12	14.5	19	27	
		μ PC78L15	17.5	23	30	
Output Current	I_o	All	0	40	70	mA
Operating Temperature Range	T_{opt}	All	-20		+85	$^{\circ}$ C
Operating Junction Temperature Range	$T_{opt(j)}$	All	-20		+125	$^{\circ}$ C

ELECTRICAL CHARACTERISTICS μ PC78L05

($V_{IN} = 10$ V, $I_o = 40$ mA, 0 $^{\circ}$ C $\leq T_j \leq +125$ $^{\circ}$ C, $C_{IN} = 0.33$ μ F, $C_{OUT} = 0.1$ μ F)

CHARACTERISTIC	SYMBOL	TEST CONDITIONS	MIN.	TYP.	MAX.	UNIT
Output Voltage	V_o	$T_j = 25$ $^{\circ}$ C	4.8	5.0	5.2	V
		7 V $\leq V_{IN} \leq 20$ V, 1 mA $\leq I_o \leq 40$ mA	4.75		5.25	
		$V_{IN} = 10$ V, 1 mA $\leq I_o \leq 70$ mA	4.75		5.25	
Line Regulation	REG_{IN}	$T_j = 25$ $^{\circ}$ C, 7 V $\leq V_{IN} \leq 20$ V		6	150	mV
		$T_j = 25$ $^{\circ}$ C, 8 V $\leq V_{IN} \leq 20$ V		4	100	
Load Regulation	REG_L	$T_j = 25$ $^{\circ}$ C, 1 mA $\leq I_o \leq 100$ mA		9	60	mV
		$T_j = 25$ $^{\circ}$ C, 1 mA $\leq I_o \leq 40$ mA		4	30	
Quiescent Current	I_{BIAS}	$T_j = 25$ $^{\circ}$ C		2.3	5.5	mA
Quiescent Current Change	ΔI_{BIAS}	8 V $\leq V_{IN} \leq 20$ V, $I_o = 40$ mA			1.5	mA
		$V_{IN} = 10$ V, 1 mA $\leq I_o \leq 40$ mA			0.1	
Output Noise Voltage	V_n	$T_j = 25$ $^{\circ}$ C, 10 Hz $\leq f \leq 100$ kHz		45	120	μ V _{r.m.s.}
Ripple Rejection	R · R	$T_j = 25$ $^{\circ}$ C, $f = 120$ Hz, 8 V $\leq V_{IN} \leq 18$ V	55	75		dB
Dropout Voltage	V_{DIF}	$T_j = 25$ $^{\circ}$ C		1.7		V
Short Circuit Current	I_{Oshort}	$T_j = 25$ $^{\circ}$ C, $V_{IN} = 20$ V		88		mA
Peak Output Current	I_{Opeak}	$T_j = 25$ $^{\circ}$ C		125	205	mA
Temperature coefficient of Output Voltage	$\Delta V_o/\Delta T$	$I_o = 5$ mA		0.4		mV/ $^{\circ}$ C

ELECTRICAL CHARACTERISTICS μ PC78L06

($V_{IN} = 11\text{ V}$, $I_o = 40\text{ mA}$, $0\text{ }^\circ\text{C} \leq T_j \leq +125\text{ }^\circ\text{C}$, $C_{IN} = 0.33\text{ }\mu\text{F}$, $C_{OUT} = 0.1\text{ }\mu\text{F}$)

CHARACTERISTIC	SYMBOL	TEST CONDITIONS	MIN.	TYP.	MAX.	UNIT
Output Voltage	V_o	$T_j = 25\text{ }^\circ\text{C}$	5.76	6.0	6.24	V
		$8.5\text{ V} \leq V_{IN} \leq 21\text{ V}$, $1\text{ mA} \leq I_o \leq 40\text{ mA}$	5.70		6.30	
		$V_{IN} = 11\text{ V}$, $1\text{ mA} \leq I_o \leq 70\text{ mA}$	5.70		6.30	
Line Regulation	REG _{IN}	$T_j = 25\text{ }^\circ\text{C}$, $8.5\text{ V} \leq V_{IN} \leq 21\text{ V}$		6	155	mV
		$T_j = 25\text{ }^\circ\text{C}$, $9\text{ V} \leq V_{IN} \leq 21\text{ V}$		4	105	
Load Regulation	REG _L	$T_j = 25\text{ }^\circ\text{C}$, $1\text{ mA} \leq I_o \leq 100\text{ mA}$		10	65	mV
		$T_j = 25\text{ }^\circ\text{C}$, $1\text{ mA} \leq I_o \leq 40\text{ mA}$		4	35	
Quiescent Current	I _{BIAS}	$T_j = 25\text{ }^\circ\text{C}$		2.3	5.5	mA
Quiescent Current Change	ΔI_{BIAS}	$9\text{ V} \leq V_{IN} \leq 21\text{ V}$, $I_o = 40\text{ mA}$			1.5	mA
		$V_{IN} = 11\text{ V}$, $1\text{ mA} \leq I_o \leq 40\text{ mA}$			0.1	
Output Noise Voltage	V_n	$T_j = 25\text{ }^\circ\text{C}$, $10\text{ Hz} \leq f \leq 100\text{ kHz}$		55	145	$\mu\text{V}_{r.m.s.}$
Ripple Rejection	R · R	$T_j = 25\text{ }^\circ\text{C}$, $f = 120\text{ Hz}$, $9\text{ V} \leq V_{IN} \leq 19\text{ V}$	54	75		dB
Dropout Voltage	V_{DIF}	$T_j = 25\text{ }^\circ\text{C}$		1.7		V
Short Circuit Current	$I_{o\text{short}}$	$T_j = 25\text{ }^\circ\text{C}$, $V_{IN} = 21\text{ V}$		85		mA
Peak Output Current	$I_{o\text{peak}}$	$T_j = 25\text{ }^\circ\text{C}$	125	160	205	mA
Temperature coefficient of Output Voltage	$\Delta V_o/\Delta T$	$I_o = 5\text{ mA}$		0.5		mV/°C

ELECTRICAL CHARACTERISTICS μ PC78L07

($V_{IN} = 12\text{ V}$, $I_o = 40\text{ mA}$, $0\text{ }^\circ\text{C} \leq T_j \leq +125\text{ }^\circ\text{C}$, $C_{IN} = 0.33\text{ }\mu\text{F}$, $C_{OUT} = 0.1\text{ }\mu\text{F}$)

CHARACTERISTIC	SYMBOL	TEST CONDITIONS	MIN.	TYP.	MAX.	UNIT
Output Voltage	V_o	$T_j = 25\text{ }^\circ\text{C}$	6.72	7.0	7.28	V
		$9.5\text{ V} \leq V_{IN} \leq 22\text{ V}$, $1\text{ mA} \leq I_o \leq 40\text{ mA}$	6.65		7.35	
		$V_{IN} = 12\text{ V}$, $1\text{ mA} \leq I_o \leq 70\text{ mA}$	6.65		7.35	
Line Regulation	REG _{IN}	$T_j = 25\text{ }^\circ\text{C}$, $9.5\text{ V} \leq V_{IN} \leq 22\text{ V}$		8	165	mV
		$T_j = 25\text{ }^\circ\text{C}$, $10\text{ V} \leq V_{IN} \leq 22\text{ V}$		5	115	
Load Regulation	REG _L	$T_j = 25\text{ }^\circ\text{C}$, $1\text{ mA} \leq I_o \leq 100\text{ mA}$		12	75	mV
		$T_j = 25\text{ }^\circ\text{C}$, $1\text{ mA} \leq I_o \leq 40\text{ mA}$		5	35	
Quiescent Current	I _{BIAS}	$T_j = 25\text{ }^\circ\text{C}$		2.3	5.5	mA
Quiescent Current Change	ΔI_{BIAS}	$10\text{ V} \leq V_{IN} \leq 22\text{ V}$, $I_o = 40\text{ mA}$			1.5	mA
		$V_{IN} = 12\text{ V}$, $1\text{ mA} \leq I_o \leq 40\text{ mA}$			0.1	
Output Noise Voltage	V_n	$T_j = 25\text{ }^\circ\text{C}$, $10\text{ Hz} \leq f \leq 100\text{ kHz}$		70	180	$\mu\text{V}_{r.m.s.}$
Ripple Rejection	R · R	$T_j = 25\text{ }^\circ\text{C}$, $f = 120\text{ Hz}$, $10\text{ V} \leq V_{IN} \leq 20\text{ V}$	52	74		dB
Dropout Voltage	V_{DIF}	$T_j = 25\text{ }^\circ\text{C}$		1.7		V
Short Circuit Current	$I_{o\text{short}}$	$T_j = 25\text{ }^\circ\text{C}$, $V_{IN} = 22\text{ V}$		83		mA
Peak Output Current	$I_{o\text{peak}}$	$T_j = 25\text{ }^\circ\text{C}$	125	160	205	mA
Temperature coefficient of Output Voltage	$\Delta V_o/\Delta T$	$I_o = 5\text{ mA}$		0.6		mV/°C

ELECTRICAL CHARACTERISTICS μPC78L08

($V_{IN} = 14\text{ V}$, $I_o = 40\text{ mA}$, $0\text{ °C} \leq T_j \leq +125\text{ °C}$, $C_{IN} = 0.33\text{ μF}$, $C_{OUT} = 0.1\text{ μF}$)

CHARACTERISTIC	SYMBOL	TEST CONDITIONS	MIN.	TYP.	MAX.	UNIT
Output Voltage	V_o	$T_j = 25\text{ °C}$	7.7	8.0	8.3	V
		$10.5\text{ V} \leq V_{IN} \leq 23\text{ V}$, $1\text{ mA} \leq I_o \leq 40\text{ mA}$	7.6		8.4	
		$V_{IN} = 14\text{ V}$, $1\text{ mA} \leq I_o \leq 70\text{ mA}$	7.6		8.4	
Line Regulation	REG_{IN}	$T_j = 25\text{ °C}$, $10.5\text{ V} \leq V_{IN} \leq 23\text{ V}$		10	175	mV
		$T_j = 25\text{ °C}$, $11\text{ V} \leq V_{IN} \leq 23\text{ V}$		6	125	
Load Regulation	REG_L	$T_j = 25\text{ °C}$, $1\text{ mA} \leq I_o \leq 100\text{ mA}$		14	80	mV
		$T_j = 25\text{ °C}$, $1\text{ mA} \leq I_o \leq 40\text{ mA}$		6	40	
Quiescent Current	I_{BIAS}	$T_j = 25\text{ °C}$		2.4	5.5	mA
Quiescent Current Change	ΔI_{BIAS}	$12\text{ V} \leq V_{IN} \leq 23\text{ V}$, $I_o = 40\text{ mA}$			1.5	mA
		$V_{IN} = 14\text{ V}$, $1\text{ mA} \leq I_o \leq 40\text{ mA}$			0.1	
Output Noise Voltage	V_n	$T_j = 25\text{ °C}$, $10\text{ Hz} \leq f \leq 100\text{ kHz}$		85	190	μV _{r.m.s.}
Ripple Rejection	$R \cdot R$	$T_j = 25\text{ °C}$, $f = 120\text{ Hz}$, $12\text{ V} \leq V_{IN} \leq 22\text{ V}$	51	73		dB
Dropout Voltage	V_{DIF}	$T_j = 25\text{ °C}$		1.7		V
Short Circuit Current	I_{Oshort}	$T_j = 25\text{ °C}$, $V_{IN} = 23\text{ V}$		80		mA
Peak Output Current	I_{Opeak}	$T_j = 25\text{ °C}$	125	160	205	mA
Temperature coefficient of Output Voltage	$\Delta V_o / \Delta T$	$I_o = 5\text{ mA}$		0.6		mV/°C

ELECTRICAL CHARACTERISTICS μPC78L10

($V_{IN} = 17\text{ V}$, $I_o = 40\text{ mA}$, $0\text{ °C} \leq T_j \leq +125\text{ °C}$, $C_{IN} = 0.33\text{ μF}$, $C_{OUT} = 0.1\text{ μF}$)

CHARACTERISTIC	SYMBOL	TEST CONDITIONS	MIN.	TYP.	MAX.	UNIT
Output Voltage	V_o	$T_j = 25\text{ °C}$	9.6	10	10.4	V
		$12.5\text{ V} \leq V_{IN} \leq 25\text{ V}$, $1\text{ mA} \leq I_o \leq 40\text{ mA}$	9.5		10.5	
		$V_{IN} = 17\text{ V}$, $1\text{ mA} \leq I_o \leq 70\text{ mA}$	9.5		10.5	
Line Regulation	REG_{IN}	$T_j = 25\text{ °C}$, $12.5\text{ V} \leq V_{IN} \leq 25\text{ V}$		12	200	mV
		$T_j = 25\text{ °C}$, $13\text{ V} \leq V_{IN} \leq 25\text{ V}$		8	150	
Load Regulation	REG_L	$T_j = 25\text{ °C}$, $1\text{ mA} \leq I_o \leq 100\text{ mA}$		18	90	mV
		$T_j = 25\text{ °C}$, $1\text{ mA} \leq I_o \leq 40\text{ mA}$		8	45	
Quiescent Current	I_{BIAS}	$T_j = 25\text{ °C}$		2.5	5.5	mA
Quiescent Current Change	ΔI_{BIAS}	$13\text{ V} \leq V_{IN} \leq 25\text{ V}$, $I_o = 40\text{ mA}$			1.5	mA
		$V_{IN} = 17\text{ V}$, $1\text{ mA} \leq I_o \leq 40\text{ mA}$			0.1	
Output Noise Voltage	V_n	$T_j = 25\text{ °C}$, $10\text{ Hz} \leq f \leq 100\text{ kHz}$		100	230	μV _{r.m.s.}
Ripple Rejection	$R \cdot R$	$T_j = 25\text{ °C}$, $f = 120\text{ Hz}$, $14\text{ V} \leq V_{IN} \leq 24\text{ V}$	49	69		dB
Dropout Voltage	V_{DIF}	$T_j = 25\text{ °C}$		1.7		V
Short Circuit Current	I_{Oshort}	$T_j = 25\text{ °C}$, $V_{IN} = 25\text{ V}$		70		mA
Peak Output Current	I_{Opeak}	$T_j = 25\text{ °C}$	125	160	205	mA
Temperature coefficient of Output Voltage	$\Delta V_o / \Delta T$	$I_o = 5\text{ mA}$		0.8		mV/°C

ELECTRICAL CHARACTERISTICS μ PC78L12

($V_{IN} = 19\text{ V}$, $I_o = 40\text{ mA}$, $0\text{ }^\circ\text{C} \leq T_j \leq +125\text{ }^\circ\text{C}$, $C_{IN} = 0.33\text{ }\mu\text{F}$, $C_{OUT} = 0.1\text{ }\mu\text{F}$)

CHARACTERISTIC	SYMBOL	TEST CONDITIONS	MIN.	TYP.	MAX.	UNIT
Output Voltage	V_o	$T_j = 25\text{ }^\circ\text{C}$	11.5	12	12.5	V
		$14\text{ V} \leq V_{IN} \leq 27\text{ V}$, $1\text{ mA} \leq I_o \leq 40\text{ mA}$	11.4		12.6	
		$V_{IN} = 19\text{ V}$, $1\text{ mA} \leq I_o \leq 70\text{ mA}$	11.4		12.6	
Line Regulation	REG _{IN}	$T_j = 25\text{ }^\circ\text{C}$, $14.5\text{ V} \leq V_{IN} \leq 27\text{ V}$		14	250	mV
		$T_j = 25\text{ }^\circ\text{C}$, $16\text{ V} \leq V_{IN} \leq 27\text{ V}$		10	200	
Load Regulation	REG _L	$T_j = 25\text{ }^\circ\text{C}$, $1\text{ mA} \leq I_o \leq 100\text{ mA}$		20	100	mV
		$T_j = 25\text{ }^\circ\text{C}$, $1\text{ mA} \leq I_o \leq 40\text{ mA}$		10	50	
Quiescent Current	I _{BIAS}	$T_j = 25\text{ }^\circ\text{C}$		2.6	5.5	mA
Quiescent Current Change	ΔI_{BIAS}	$16\text{ V} \leq V_{IN} \leq 27\text{ V}$, $I_o = 40\text{ mA}$			1.5	mA
		$V_{IN} = 19\text{ V}$, $1\text{ mA} \leq I_o \leq 40\text{ mA}$			0.1	
Output Noise Voltage	V_n	$T_j = 25\text{ }^\circ\text{C}$, $10\text{ Hz} \leq f \leq 100\text{ kHz}$		115	280	$\mu\text{V}_{r.m.s.}$
Ripple Rejection	R · R	$T_j = 25\text{ }^\circ\text{C}$, $f = 120\text{ Hz}$, $15\text{ V} \leq V_{IN} \leq 25\text{ V}$	47	66		dB
Dropout Voltage	V _{DIF}	$T_j = 25\text{ }^\circ\text{C}$		1.7		V
Short Circuit Current	I _{oshort}	$T_j = 25\text{ }^\circ\text{C}$, $V_{IN} = 27\text{ V}$		64		mA
Peak Output Current	I _{Opeak}	$T_j = 25\text{ }^\circ\text{C}$	125	160	205	mA
Temperature coefficient of Output Voltage	$\Delta V_o / \Delta T$	$I_o = 5\text{ mA}$		1.1		mV/°C

ELECTRICAL CHARACTERISTICS μ PC78L15

($V_{IN} = 23\text{ V}$, $I_o = 40\text{ mA}$, $0\text{ }^\circ\text{C} \leq T_j \leq +125\text{ }^\circ\text{C}$, $C_{IN} = 0.33\text{ }\mu\text{F}$, $C_{OUT} = 0.1\text{ }\mu\text{F}$)

CHARACTERISTIC	SYMBOL	TEST CONDITIONS	MIN.	TYP.	MAX.	UNIT
Output Voltage	V_o	$T_j = 25\text{ }^\circ\text{C}$	14.4	15	15.6	V
		$17.5\text{ V} \leq V_{IN} \leq 30\text{ V}$, $1\text{ mA} \leq I_o \leq 40\text{ mA}$	14.25		15.75	
		$V_{IN} = 23\text{ V}$, $1\text{ mA} \leq I_o \leq 70\text{ mA}$	14.25		15.75	
Line Regulation	REG _{IN}	$T_j = 25\text{ }^\circ\text{C}$, $17.5\text{ V} \leq V_{IN} \leq 30\text{ V}$		18	300	mV
		$T_j = 25\text{ }^\circ\text{C}$, $20\text{ V} \leq V_{IN} \leq 30\text{ V}$		13	250	
Load Regulation	REG _L	$T_j = 25\text{ }^\circ\text{C}$, $1\text{ mA} \leq I_o \leq 100\text{ mA}$		25	150	mV
		$T_j = 25\text{ }^\circ\text{C}$, $1\text{ mA} \leq I_o \leq 40\text{ mA}$		12	75	
Quiescent Current	I _{BIAS}	$T_j = 25\text{ }^\circ\text{C}$		2.7	5.5	mA
Quiescent Current Change	ΔI_{BIAS}	$20\text{ V} \leq V_{IN} \leq 30\text{ V}$, $I_o = 40\text{ mA}$			1.5	mA
		$V_{IN} = 23\text{ V}$, $1\text{ mA} \leq I_o \leq 40\text{ mA}$			0.1	
Output Noise Voltage	V_n	$T_j = 25\text{ }^\circ\text{C}$, $10\text{ Hz} \leq f \leq 100\text{ kHz}$		135	350	$\mu\text{V}_{r.m.s.}$
Ripple Rejection	R · R	$T_j = 25\text{ }^\circ\text{C}$, $f = 120\text{ Hz}$, $18.5\text{ V} \leq V_{IN} \leq 28.5\text{ V}$	45	61		dB
Dropout Voltage	V _{DIF}	$T_j = 25\text{ }^\circ\text{C}$		1.7		V
Short Circuit Current	I _{oshort}	$T_j = 25\text{ }^\circ\text{C}$, $V_{IN} = 30\text{ V}$		53		mA
Peak Output Current	I _{Opeak}	$T_j = 25\text{ }^\circ\text{C}$	125	160	205	mA
Temperature coefficient of Output Voltage	$\Delta V_o / \Delta T$	$I_o = 5\text{ mA}$		1.4		mV/°C

TYPICAL CHARACTERISTICS ($T_a = 25^\circ\text{C}$)

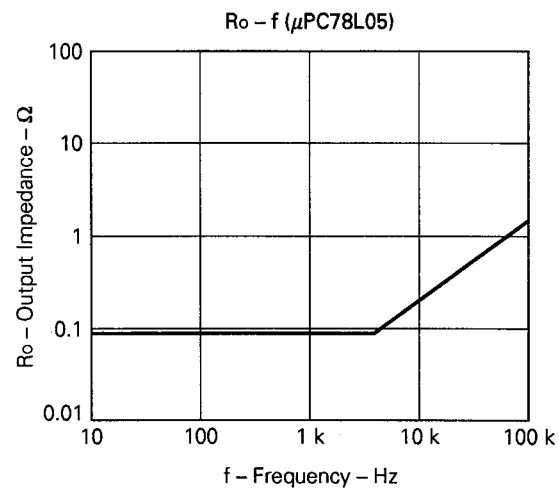
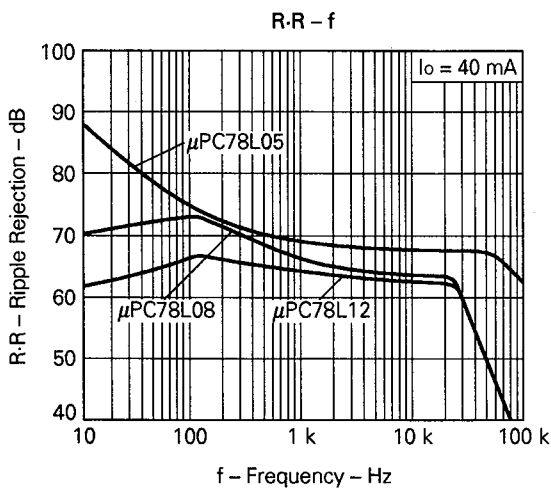
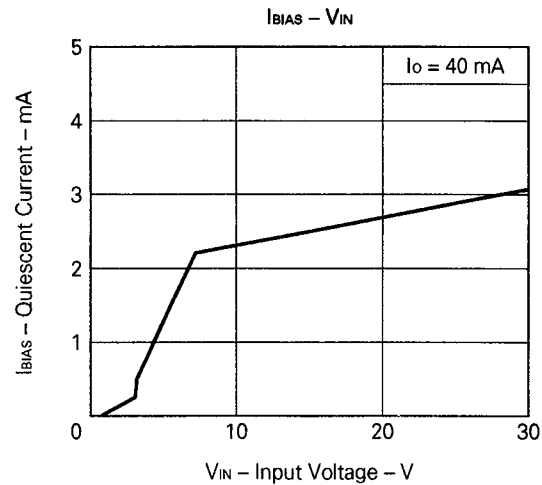
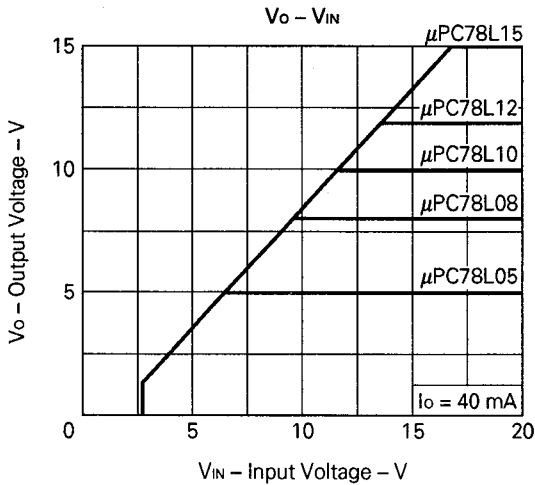
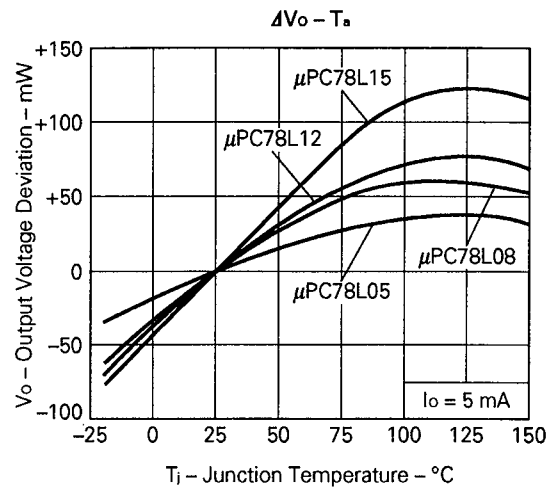
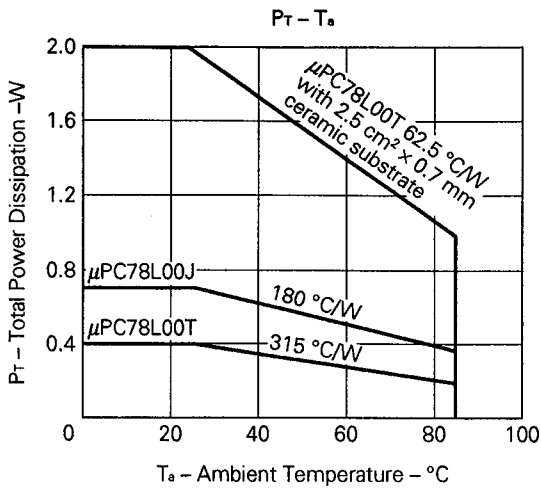

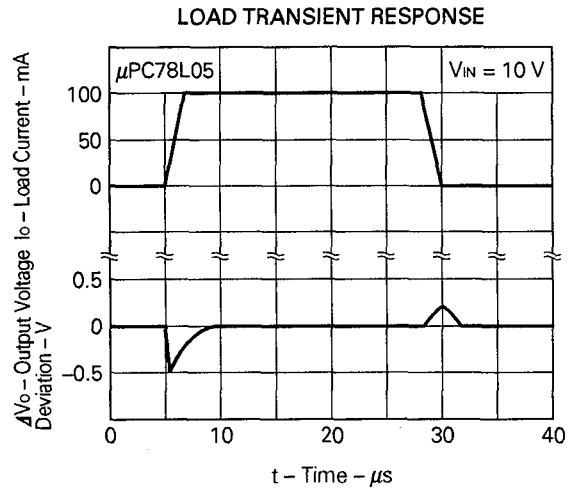
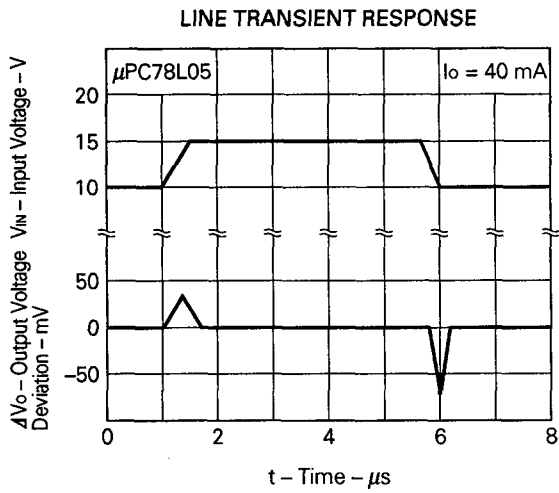
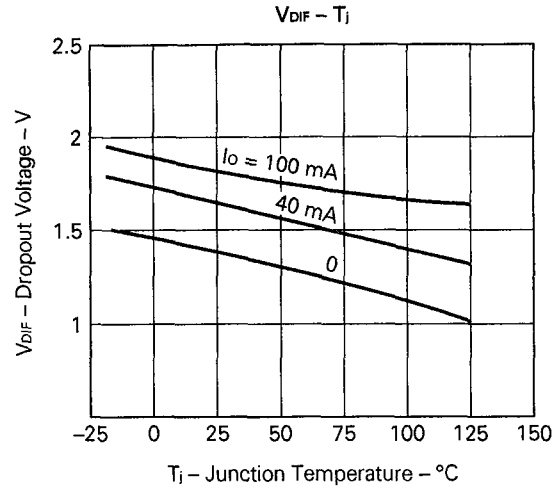
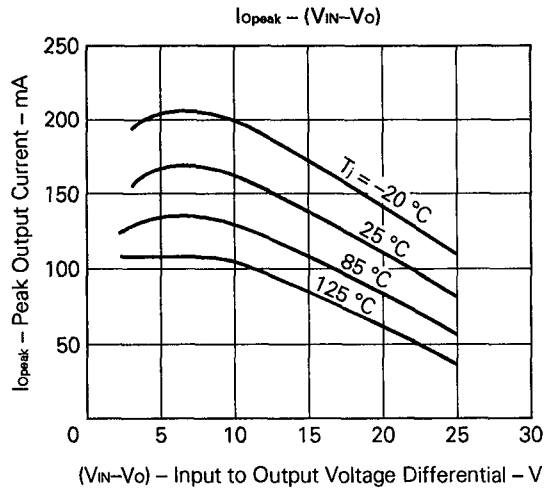

PACKAGE DIMENSIONS (Unit: mm)

μPC78L00J Series

3 PIN PLASTIC SIP (TO-92)

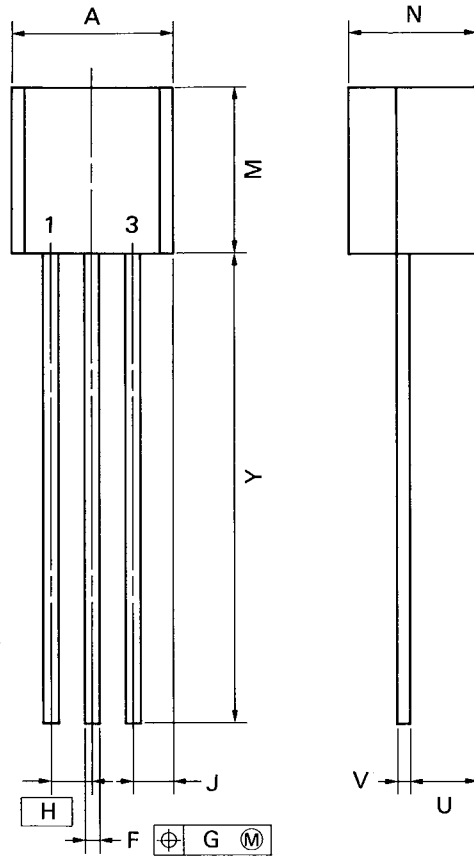

P3J-127B

NOTE

Each lead centerline is located within 0.12 mm (0.005 inch) of its true position (T.P.) at maximum material condition.

ITEM	MILLIMETERS	INCHES
A	5.2 MAX.	0.205 MAX.
F	0.5 ^{+0.3}	0.02 ^{+0.012}
G	0.12	0.005
H	1.27	0.05
J	1.33 MAX.	0.053 MAX.
M	5.5 MAX.	0.217 MAX.
N	4.2 MAX.	0.166 MAX.
U	2.8 MAX.	0.111 MAX.
V	0.5 ^{+0.1}	0.02 ^{+0.004}
Y	15.0 ^{+0.7}	0.591 ^{+0.028}

μ PC78L00T Series

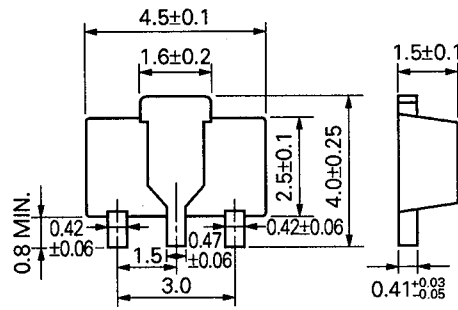

RECOMMENDED SOLDERING CONDITIONS

The following conditions (see table below) must be met when soldering this product.

Please consult with our sales offices in case other soldering process is used, or in case soldering is done under different conditions.

<TYPES OF SURFACE MOUNT DEVICE>

For more details, refer to our document "SMT MANUAL" (IEI-1207).

[μPC78L00T Series]

Soldering process	Soldering condition	Symbol
Infrared ray reflow	Peak package's surface temperature: 230 °C or below, Reflow time: 30 seconds or below (210 °C or higher), Number of reflow process: 1, Exposure limit*: None	IR30-00
VPS	Peak package's surface temperature: 215 °C or below, Reflow time: 40 seconds or below (200 °C or higher), Number of reflow process: 1, Exposure limit*: None	VP15-00

*: Exposure limit before soldering after dry-pack package is opened. Storage conditions: 25 °C and relative humidity at 65% or less.

Note: Do not apply more than a single process at once, except for "Partial heating method".

<TYPES OF THROUGH HOLE MOUNT DEVICE>

[μPC78L00J Series]

Soldering process	Soldering condition	Symbol
Wave soldering	Solder temperature: 260 °C or below, Flow time: 10 seconds or below	

Reference

Application note name	No.
Quality control of NEC semiconductor devices	TEI-1202
Quality control guide of semiconductor devices	MEI-1202
Assembly manual of semiconductor devices	IEI-1207
NEC semiconductor device reliability/quality control system	IEI-1212

No part of this document may be copied or reproduced in any form or by any means without the prior written consent of NEC Corporation. NEC Corporation assumes no responsibility for any errors which may appear in this document.

NEC Corporation does not assume any liability for infringement of patents, copyrights or other intellectual property rights of third parties by or arising from use of a device described herein or any other liability arising from use of such device. No license, either express, implied or otherwise, is granted under any patents, copyrights or other intellectual property rights of NEC Corporation or others.

The devices listed in this document are not suitable for use in aerospace equipment, submarine cables, nuclear reactor control systems and life support systems. If customers intend to use NEC devices for above applications or they intend to use "Standard" quality grade NEC devices for applications not intended by NEC, please contact our sales people in advance.

Application examples recommended by NEC Corporation.

Standard: Computer, Office equipment, Communication equipment, Test and Measurement equipment, Machine tools, Industrial robots, Audio and Visual equipment, Other consumer products, etc.

Special: Automotive and Transportation equipment, Traffic control systems, Antidisaster systems, Anticrime systems, etc.