

## 4 A Forced PWM Step-down DC/DC Converter with Synchronous Rectifier

No. EA-366-190515

### OVERVIEW

The RP510L is a low input voltage step-down DC/DC converter that operates from 2.5 V to 5.5 V and provides up to 4 A of output current <sup>(1)</sup>. It is suitable for power supply of SoC (System-on-a-chip). It is also available in a foldback type overcurrent protection which automatically recovers to the normal state after the cause of overcurrent is removed.

### KEY BENEFITS

- The realization of the high-density mounting by the adoption of a small package DFN3030-12.
- A simplification of the power sequencing by power-good and adjustable soft-start functions.
- Selectable overcurrent protection: Latch type or Foldback type.

### KEY SPECIFICATIONS

- Operating Temperature Range: -40°C to 85°C
- Output Voltage Range<sup>(2)</sup>: 0.8 V to 3.3 V
- Output Voltage Accuracy<sup>(3)</sup>:  $\pm 1\%$  ( $V_{SET} \geq 1.2$  V),  
 $\pm 12$  mV ( $V_{SET} < 1.2$  V)
- Feedback Voltage Accuracy<sup>(4)</sup>:  $\pm 6$  mV ( $V_{FB} = 0.6$  V)
- Output/Feedback Voltage Temperature Coefficient:  $\pm 100$  ppm/°C
- Standby Current: Typ. 0.35  $\mu$ A (RP510LxxN)  
Typ. 0.01  $\mu$ A or less (RP510LxxG/H/J)
- Oscillator Frequency: Typ. 2.3 MHz
- Built-in Driver On-resistance (Pch./Nch.): Typ. 0.04  $\Omega$  ( $V_{IN} = 3.6$  V)
- Maximum Duty Cycle: Min. 100%
- Minimum On Time: Typ. 55 ns
- Protection Features: UVLO, LX Peak Current Limit, Overcurrent protection (Latch/Foldback type), and Thermal shutdown.

### TYPICAL CHARACTERISTICS

$V_{OUT} = 1.2$  V,  $V_{IN} = 3.3$  V/5.0 V ( $T_a = 25^\circ\text{C}$ )

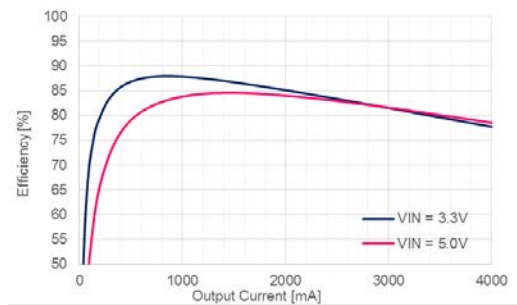

### TYPICAL APPLICATION CIRCUIT

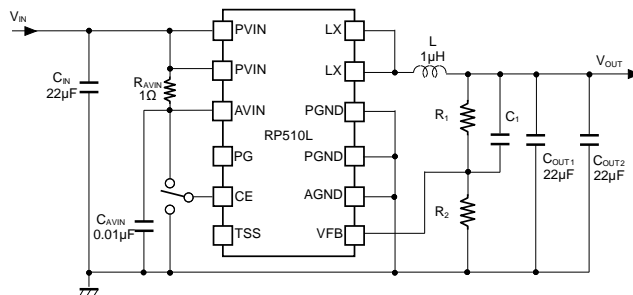

RP510L001G/1H/4G/4H (Adjustable Output Voltage Type)

### PACKAGE



DFN3030-12  
3.0 x 3.0 x 0.8<sup>(1)</sup> mm  
<sup>(1)</sup> maximum dimension

### APPLICATIONS

- POL (Point of Load) Converter, and Micro-processor Power Supply with using Battery
- Server, Networking Equipment, FPGA, and DSP

<sup>(1)</sup> The maximum allowable output current is 4 A but it is a criterion and can be affected by conditions and external parts.  
<sup>(2)</sup> Refer to the section *SELECTION GUIDE* for details of  $V_{SET}$ .  
<sup>(3)</sup> Fixed Output Voltage Type  
<sup>(4)</sup> Adjustable Output Voltage Type

---

## RP510L

---

No. EA-366-190515

### SELECTION GUIDE

The set output voltage, the output voltage type, the auto-discharge function<sup>(1)</sup>, and the protection type are user-selectable options.

#### Selection Guide

Product Name	Package	Quantity per Reel	Pb Free	Halogen Free
RP510Lxx\$\$-TR	DFN3030-12	3,000 pcs	Yes	Yes

xx: Set Output Voltage ( $V_{SET}$ ).

Fixed Output Voltage Type: 08 (0.8 V), 10 (1.0 V), 11 (1.1 V), 12 (1.2 V), 13 (1.3 V), 15 (1.5 V),  
18 (1.8 V), 30 (3.0 V), 33 (3.3 V)

Adjustable Output Voltage Type: 00 (0.8 V to 3.3 V)

\$\$: Other Functions

Version	Output Voltage Type	Auto-discharge Function	Oscillator Frequency	Protection Type
RP510Lxx1G	Fixed	No	2.3 MHz	Latch
RP510Lxx1H		Yes		
RP510L001J	Adjustable	No		
RP510L001N		Yes		
RP510Lxx4G	Fixed	No		Foldback
RP510Lxx4H		Yes		
RP510L004J	Adjustable	No		
RP510L004N		Yes		

---

<sup>(1)</sup> Auto-discharge function quickly lowers the output voltage to 0 V, when the chip enable signal is switched from the active mode to the standby mode, by releasing the electrical charge accumulated in the external capacitor.

---



---

**RP510L**

---

No. EA-366-190515

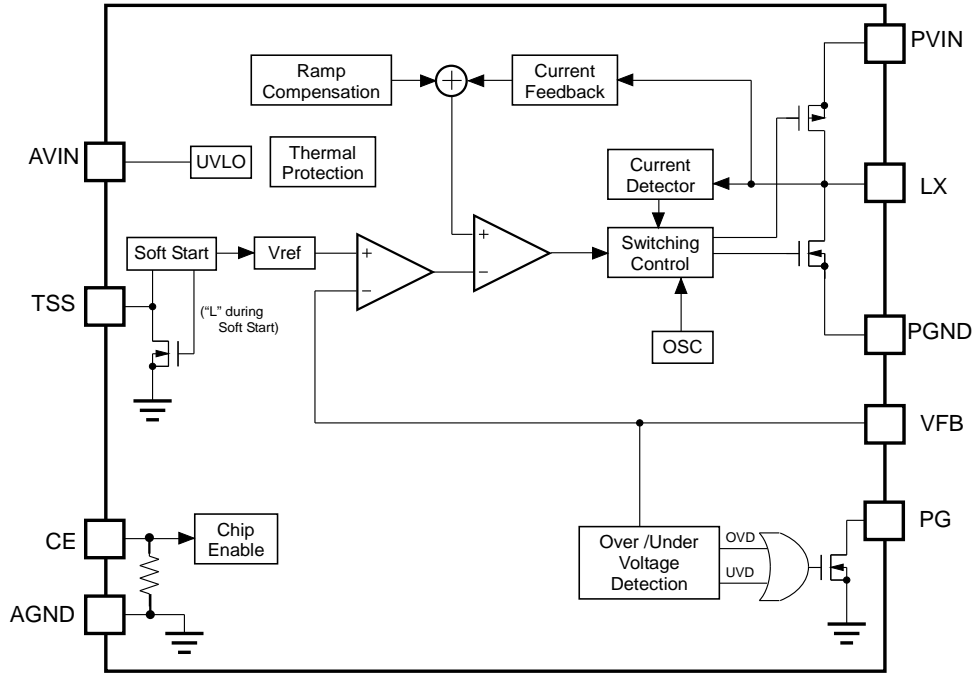
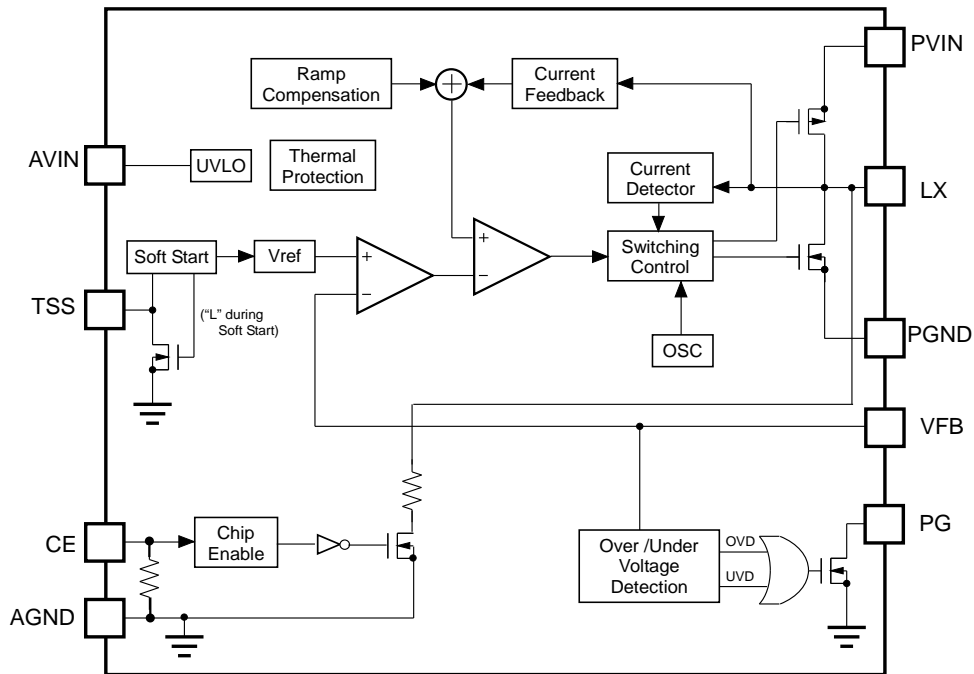
**RP510L001J/4J/1N/4N (Adjustable Output Voltage Type)****RP510L001J/ 4J Block Diagram****RP510L001N/ 4N Block Diagram**

## PIN DESCRIPTION

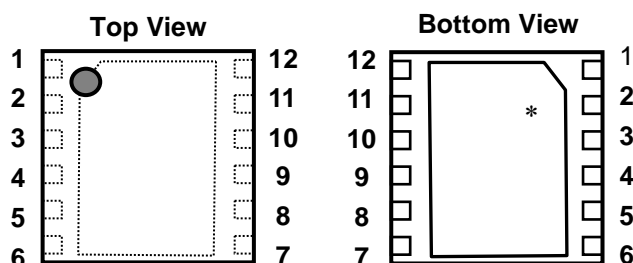

DFN3030-12 Pin Configurations

### DFN3030-12 Pin Description

Pin No.	Pin Name	Description
1	PVIN <sup>(1)</sup>	Input Voltage Pin
2	PVIN <sup>(1)</sup>	Input Voltage Pin
3	AVIN <sup>(2)</sup>	Input Voltage Pin
4	PG	Power Good Pin, NMOS Open-drain
5	CE	Chip Enable Pin, Active-high
6	TSS	Soft-start Pin
7	VOUT/ VFB	Output Voltage Pin / Feedback Voltage Pin
8	AGND <sup>(3)</sup>	Analog Ground Pin
9	PGND <sup>(3)</sup>	Power Ground Pin
10	PGND <sup>(3)</sup>	Power Ground Pin
11	LX	Switching Pin
12	LX	Switching Pin

\* The tab on the bottom of the package must be connected to the ground plane on the board to enhance thermal performance.

<sup>(1)</sup> No.1 pin and No.2 pin must be wired to the V<sub>IN</sub> plane when mounting on boards.

<sup>(2)</sup> No.3 pin must be wired to No.1 and No.2 pins via a low-pass filter (LPF: 1 Ω, 10 nF) when mounting on boards.

<sup>(3)</sup> No.8 pin, No.9 pin and No.10 pin must be wired to the GND plane when mounting on boards.

## RP510L

No. EA-366-190515

## ABSOLUTE MAXIMUM RATINGS

### Absolute Maximum Ratings

(AGND = PGND = 0 V)

Symbol	Parameter			Rating	Unit
$V_{IN}$	A/PVIN Pin Voltage			-0.3 to 6.5	V
$V_{LX}$	LX Pin Voltage			-0.3 to $V_{IN} + 0.3$	V
$V_{CE}$	CE Pin Voltage			-0.3 to 6.5	V
$V_{OUT}/V_{FB}$	Output Voltage / Feedback Voltage			-0.3 to 6.5	V
$V_{PG}$	PG Pin Voltage			-0.3 to 6.5	V
$V_{TSS}$	TSS Pin Voltage			-0.3 to $V_{IN} + 0.3$	V
$P_D$	Power Dissipation <sup>(1)</sup>	DFN3030-12	JEDEC STD. 51-7	3400	mW
$T_j$	Junction Temperature Range			-40 to 125	°C
Tstg	Storage Temperature Range			-55 to 125	°C

### ABSOLUTE MAXIMUM RATINGS

Electronic and mechanical stress momentarily exceeded absolute maximum ratings may cause permanent damage and may degrade the life time and safety for both device and system using the device in the field. The functional operation at or over these absolute maximum ratings are not assured.

## RECOMMENDED OPERATING CONDITIONS

### Recommended Operating Conditions

Symbol	Parameter	Rating	Unit
$V_{IN}$	Input Voltage	2.5 to 5.5	V
$T_a$	Operating Temperature Range	-40 to 85	°C

### RECOMMENDED OPERATING CONDITIONS

All of electronic equipment should be designed that the mounted semiconductor devices operate within the recommended operating conditions. The semiconductor devices cannot operate normally over the recommended operating conditions, even if they are used over such conditions by momentary electronic noise or surge. And the semiconductor devices may receive serious damage when they continue to operate over the recommended operating conditions.

<sup>(1)</sup> Refer to *POWER DISSIPATION* for detailed information.

## ELECTRICAL CHARACTERISTICS

The specifications surrounded by   are guaranteed by design engineering at  $-40^{\circ}\text{C} \leq T_a \leq 85^{\circ}\text{C}$ .

### RP510Lxx1/4 Electrical Characteristics

(Ta = 25°C)

Symbol	Parameter	Test Conditions/Comments	Min.	Typ.	Max.	Unit
I <sub>STANDBY</sub>	Standby Current	V <sub>IN</sub> = 5.5 V, V <sub>CE</sub> = 0 V		0.35	<span style="border: 1px solid black; padding: 0 2px;">15.5</span>	μA
			RP510LxxxN			
				0.01	<span style="border: 1px solid black; padding: 0 2px;">7.5</span>	
R <sub>CE</sub>	CE Pin Pull-down Resistance			1		MΩ
I <sub>CEL</sub>	CE Pin Input Current, Low	V <sub>IN</sub> = 5.5 V, V <sub>CE</sub> = 0 V	<span style="border: 1px solid black; padding: 0 2px;">-1</span>	0	<span style="border: 1px solid black; padding: 0 2px;">1</span>	μA
I <sub>LXLEAKH</sub>	LX Pin Leakage Current, High	V <sub>IN</sub> = V <sub>LX</sub> = 5.5 V, V <sub>CE</sub> = 0 V	<span style="border: 1px solid black; padding: 0 2px;">-1</span>	0	<span style="border: 1px solid black; padding: 0 2px;">3</span>	μA
I <sub>LXLEAKL</sub>	LX Pin Leakage Current, Low	V <sub>IN</sub> = 5.5 V, V <sub>CE</sub> = V <sub>LX</sub> = 0 V	<span style="border: 1px solid black; padding: 0 2px;">-10</span>	0	<span style="border: 1px solid black; padding: 0 2px;">1</span>	μA
V <sub>CEH</sub>	CE Pin Input Voltage, High	V <sub>IN</sub> = 5.5 V	<span style="border: 1px solid black; padding: 0 2px;">1.0</span>			V
V <sub>CEL</sub>	CE Pin Input Voltage, Low	V <sub>IN</sub> = 2.5 V			<span style="border: 1px solid black; padding: 0 2px;">0.4</span>	V
t <sub>START1</sub>	Soft-start Time1	V <sub>IN</sub> = V <sub>CE</sub> = 3.6 V or V <sub>SET</sub> + 1 V, TSS = OPEN	<span style="border: 1px solid black; padding: 0 2px;">75</span>	150	<span style="border: 1px solid black; padding: 0 2px;">300</span>	μs
t <sub>START2</sub>	Soft-start Time2	V <sub>IN</sub> = V <sub>CE</sub> = 3.6 V or V <sub>SET</sub> + 1 V, C <sub>SS</sub> = 0.1 μF	<span style="border: 1px solid black; padding: 0 2px;">15</span>	30	<span style="border: 1px solid black; padding: 0 2px;">45</span>	ms
I <sub>LXLIM</sub>	LX Current Limit	V <sub>IN</sub> = V <sub>CE</sub> = 3.6 V or V <sub>SET</sub> + 1 V	<span style="border: 1px solid black; padding: 0 2px;">5000</span>	6500		mA
t <sub>PROT</sub>	Protection Delay Time	V <sub>IN</sub> = V <sub>CE</sub> = 3.6 V or V <sub>SET</sub> + 1 V	<span style="border: 1px solid black; padding: 0 2px;">0.5</span>	1.5	<span style="border: 1px solid black; padding: 0 2px;">5</span>	ms
V <sub>UVLO1</sub>	UVLO Threshold Voltage	V <sub>IN</sub> = V <sub>CE</sub> , Falling	<span style="border: 1px solid black; padding: 0 2px;">2.1</span>	2.2	<span style="border: 1px solid black; padding: 0 2px;">2.3</span>	V
V <sub>UVLO2</sub>		V <sub>IN</sub> = V <sub>CE</sub> , Rising	<span style="border: 1px solid black; padding: 0 2px;">2.2</span>	2.3	<span style="border: 1px solid black; padding: 0 2px;">2.4</span>	V
T <sub>TSD</sub>	Thermal Shutdown Threshold Temperature, Detection	T <sub>j</sub> , Rising		165		°C
T <sub>TSR</sub>	Thermal Shutdown Threshold Temperature, Release	T <sub>j</sub> , Falling		115		°C
R <sub>PGDIS</sub>	PG Pin Low Output ON Resistance	V <sub>IN</sub> = 3.6 V, V <sub>OUT</sub> = 0 V or V <sub>FB</sub> = 0 V		45		Ω
f <sub>OSC</sub>	Oscillation Frequency	V <sub>IN</sub> = V <sub>CE</sub> = 3.6 V or V <sub>SET</sub> + 1 V	<span style="border: 1px solid black; padding: 0 2px;">2.00</span>	2.3	<span style="border: 1px solid black; padding: 0 2px;">2.50</span>	MHz

All test items listed under Electrical Characteristics are done under the pulse load condition (T<sub>j</sub> ≈ T<sub>a</sub> = 25°C).

**RP510L**

No. EA-366-190515

The specifications surrounded by   are guaranteed by design engineering at  $-40^{\circ}\text{C} \leq T_a \leq 85^{\circ}\text{C}$ .**RP510Lxx1G/1H/4G/4H Electrical Characteristics: Fixed Output Voltage Type** (Ta = 25°C)

Symbol	Parameter	Test Conditions/Comments	Min.	Typ.	Max.	Unit	
V <sub>OUT</sub>	Output Voltage	V <sub>IN</sub> = V <sub>CE</sub> = 3.6 V or V <sub>SET</sub> + 1 V	V <sub>SET</sub> ≥ 1.2 V	x0.99		x1.01	V
				<span style="border: 1px solid black; padding: 0 2px;">x0.98</span>		<span style="border: 1px solid black; padding: 0 2px;">x1.02</span>	
			V <sub>SET</sub> < 1.2 V	-0.012		0.012	
				<span style="border: 1px solid black; padding: 0 2px;">-0.024</span>		<span style="border: 1px solid black; padding: 0 2px;">0.024</span>	
I <sub>SS</sub>	Supply Current	V <sub>IN</sub> = V <sub>CE</sub> = 5.5 V		800		μA	
I <sub>VOULT</sub>	V <sub>OUT</sub> Pin Current, Low	V <sub>IN</sub> = 5.5 V, V <sub>CE</sub> = V <sub>OUT</sub> = 0 V	<span style="border: 1px solid black; padding: 0 2px;">-1</span>	0	<span style="border: 1px solid black; padding: 0 2px;">1</span>	μA	
V <sub>OVD</sub>	OVD Voltage	V <sub>IN</sub> = 3.6 V		V <sub>SET</sub> × 1.2		V	
V <sub>UVD</sub>	UVD Voltage	V <sub>IN</sub> = 3.6 V		V <sub>SET</sub> × 0.8		V	

**RP510Lxx1G/4G: Auto-discharge Function Not Included**

I <sub>VOUTH</sub>	V <sub>OUT</sub> Pin Current, High	V <sub>IN</sub> = V <sub>OUT</sub> = 5.5 V, V <sub>CE</sub> = 0 V	<span style="border: 1px solid black; padding: 0 2px;">-1</span>	0	<span style="border: 1px solid black; padding: 0 2px;">1</span>	μA
--------------------	------------------------------------	---	--	---	---	----

**RP510Lxx1H/4H: Auto-discharge Function Included**

R <sub>VOU<sub>TDIS</sub></sub>	V <sub>OUT</sub> Pin Discharge NMOS ON-resistance	V <sub>IN</sub> = 2.5 V, V <sub>CE</sub> = 0 V, V <sub>OUT</sub> = 0.5 V		45		Ω
---------------------------------	--	--	--	----	--	---

**RP510L001J/1N/4J/4N Electrical Characteristics: Adjustable Output Voltage Type**

Symbol	Parameter	Test Conditions/Comments	Min.	Typ.	Max.	Unit
V <sub>FB</sub>	Feedback Voltage	V <sub>IN</sub> = V <sub>CE</sub> = 3.6 V	0.594	0.600	0.606	V
			<span style="border: 1px solid black; padding: 0 2px;">0.588</span>	0.600	<span style="border: 1px solid black; padding: 0 2px;">0.612</span>	
I <sub>SS</sub>	Supply Current	V <sub>IN</sub> = V <sub>CE</sub> = 5.5 V		800		μA
I <sub>VFBH</sub>	V <sub>FB</sub> Pin Current, High	V <sub>IN</sub> = V <sub>FB</sub> = 5.5 V, V <sub>CE</sub> = 0 V	<span style="border: 1px solid black; padding: 0 2px;">-1</span>	0	<span style="border: 1px solid black; padding: 0 2px;">1</span>	μA
I <sub>VFBL</sub>	V <sub>FB</sub> Pin Current, Low	V <sub>IN</sub> = 5.5 V, V <sub>CE</sub> = V <sub>FB</sub> = 0 V	<span style="border: 1px solid black; padding: 0 2px;">-1</span>	0	<span style="border: 1px solid black; padding: 0 2px;">1</span>	μA
V <sub>OVD</sub>	OVD Voltage	V <sub>IN</sub> = 3.6 V		0.72		V
V <sub>UVD</sub>	UVD Voltage	V <sub>IN</sub> = 3.6 V		0.48		V

**RP510L001N/4N: Auto-discharge Function Included**

R <sub>LXDIS</sub>	LX Pin Discharge NMOS ON-resistance	V <sub>IN</sub> = 2.5 V, V <sub>CE</sub> = 0 V, L <sub>X</sub> = 0.5 V		65		Ω
--------------------	--	--	--	----	--	---

All test items listed under Electrical Characteristics are done under the pulse load condition (T<sub>j</sub> ≈ T<sub>a</sub> = 25°C).



The specifications surrounded by   are guaranteed by design engineering at  $-40^{\circ}\text{C} \leq T_a \leq 85^{\circ}\text{C}$ .

**RP510Lxx1G/1H/4G/4H Electrical Characteristics: Fixed Output Voltage Type**

Product Name	$V_{\text{OUT}}$ [V]					
	$T_a = 25^{\circ}\text{C}$			$-40^{\circ}\text{C} \leq T_a \leq 85^{\circ}\text{C}$		
	Min.	Typ.	Max.	Min.	Typ.	Max.
RP510x08xx	0.788	0.800	0.812	<span style="border: 1px solid black; padding: 0 2px;">0.776</span>	0.800	<span style="border: 1px solid black; padding: 0 2px;">0.824</span>
RP510x10xx	0.988	1.000	1.012	<span style="border: 1px solid black; padding: 0 2px;">0.976</span>	1.000	<span style="border: 1px solid black; padding: 0 2px;">1.024</span>
RP510x11xx	1.088	1.100	1.112	<span style="border: 1px solid black; padding: 0 2px;">1.076</span>	1.100	<span style="border: 1px solid black; padding: 0 2px;">1.124</span>
RP510x12xx	1.188	1.200	1.212	<span style="border: 1px solid black; padding: 0 2px;">1.176</span>	1.200	<span style="border: 1px solid black; padding: 0 2px;">1.224</span>
RP510x13xx	1.287	1.300	1.313	<span style="border: 1px solid black; padding: 0 2px;">1.274</span>	1.300	<span style="border: 1px solid black; padding: 0 2px;">1.326</span>
RP510x15xx	1.485	1.500	1.515	<span style="border: 1px solid black; padding: 0 2px;">1.470</span>	1.500	<span style="border: 1px solid black; padding: 0 2px;">1.530</span>
RP510x18xx	1.782	1.800	1.818	<span style="border: 1px solid black; padding: 0 2px;">1.764</span>	1.800	<span style="border: 1px solid black; padding: 0 2px;">1.836</span>
RP510x30xx	2.970	3.000	3.030	<span style="border: 1px solid black; padding: 0 2px;">2.940</span>	3.000	<span style="border: 1px solid black; padding: 0 2px;">3.060</span>
RP510x33xx	3.267	3.300	3.333	<span style="border: 1px solid black; padding: 0 2px;">3.234</span>	3.300	<span style="border: 1px solid black; padding: 0 2px;">3.366</span>

**THEORY OF OPERATION**

**Soft-start**

**Starting-up with CE Pin**

The device starts to operate when the CE pin voltage ( $V_{CE}$ ) exceeds the threshold voltage. The threshold voltage is preset between CE “High” input voltage ( $V_{CEH}$ ) and CE “Low” input voltage ( $V_{CEL}$ ). The soft-start circuit also starts to operate after the device start-up. Then, after a certain period of time, the reference voltage ( $V_{REF}$ ) in the device gradually increases up to the specified value.

Notes: Soft-start time ( $t_{START}$ )<sup>(1)</sup> might not be always equal to an actual turn-on speed of the output voltage. Please note that the turn-on speed could be affected by the power supply capacity, the output current, the inductance value, and the  $C_{OUT}$  value.

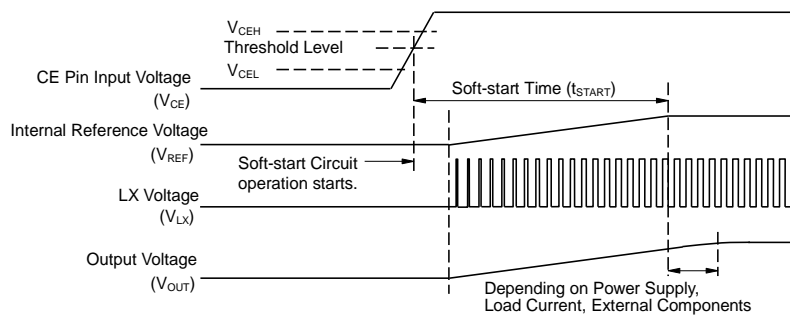

**Timing Chart when Starting-up with CE Pin**

**Starting-up with Power Supply**

After the power-on, the device starts to operate when  $V_{IN}$  exceeds the UVLO released voltage ( $V_{UVLO2}$ ). The soft-start circuit also starts to operate. Then after a certain period of time,  $V_{REF}$  gradually increases up to the specified value. Please note that the turn-on speed of  $V_{OUT}$  could be affected by the following conditions.

1. Power supply capacity and Turn-on speed of  $V_{IN}$  determined by  $C_{IN}$
2. Values of Inductor, Capacitor and Output current

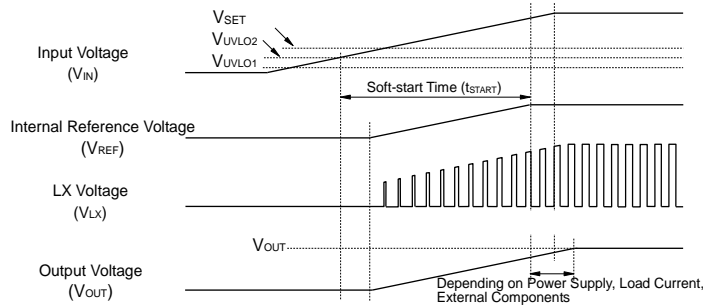

**Timing Chart when Starting-up with Power Supply**

<sup>(1)</sup> Soft-start time ( $t_{START}$ ) indicates the duration until the reference voltage ( $V_{REF}$ ) reaches the specified voltage after soft-start circuit's activation.

### Soft-start Time Adjustment

Soft-start time ( $t_{START}$ ) of the RP510L is adjustable by connecting a soft-start time adjustment capacitor ( $C_{SS}$ ) between the TSS pin and GND.  $t_{START}$  can be set from Typ. 0.15 ms as a lower limit. As the figure below shows,  $t_{START}$  is Typ. 30 ms when  $C_{SS}$  is 0.1  $\mu$ F. If not requiring to adjust  $t_{START}$ ,  $t_{START}$  is set to 0.15 ms (Typ.) by making the TSS pin open. The capacitance value for required soft-start time ( $t_{START}$ ) can be calculated by the following equation.

$$C_{SS} \text{ [nF]} = 3.5 \times t_{START} \text{ [ms]}$$

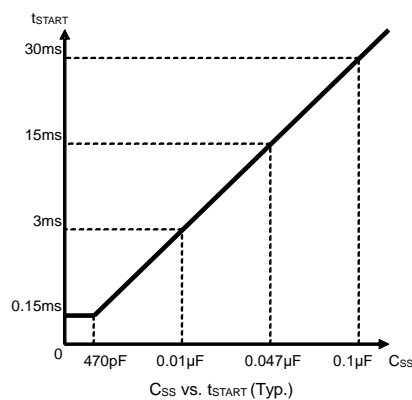

Soft-start Time ( $t_{START}$ ) vs. Soft-start Time Adjustment Capacitor ( $C_{SS}$ )

### Power Good Function

If any condition as follows is detected, power good function with using Nch. open drain turns Nch. transistor ON and switches the PG pin to “Low”. After the condition is removed, the power good function turns Nch. transistor OFF and switches the PG pin back to “High”. The time until the Nch. transistor is turned OFF includes the release delay time of 0.05 ms (Typ.).

- CE = "L" (Shutdown)
- UVLO
- Thermal Shutdown
- Over Voltage Detection (Typ.):  
 $V_{OUT} > V_{SET} \times 1.2 \text{ V (RP510Lxx1G/1H/4G/4H)}$  or  $V_{FB} > 0.72 \text{ V (RP510L001J/1N/4J/4N)}$
- Under Voltage Detection (Typ.):  
 $V_{OUT} < V_{SET} \times 0.8 \text{ V (RP510Lxx1G/1H/4G/4H)}$  or  $V_{FB} < 0.48 \text{ V (RP510L001J/1N/4J/4N)}$
- During the Latch Type Protecting operation

Notes: When using the power good function, the resistance of PG pin ( $R_{PG}$ ) should be between 10 k $\Omega$  to 100 k $\Omega$ . The PG pin must be open or connected to GND if the power good function is not used.

**Under Voltage Lockout (UVLO)**

If  $V_{IN}$  becomes lower than  $V_{SET}$ , the step-down DC/DC converter stops the switching operation and ON duty becomes 100%, and then  $V_{OUT}$  gradually drops according to  $V_{IN}$ .

If the  $V_{IN}$  drops more and becomes lower than the UVLO detector threshold ( $V_{UVLO1}$ ), the UVLO circuit starts to operate,  $V_{REF}$  stops, and Pch. and Nch. built-in transistors become the OFF state. As a result,  $V_{OUT}$  drops according to the  $C_{OUT}$  capacitance value and the load.

To restart the operation,  $V_{IN}$  is required to be higher than  $V_{UVLO2}$ . The timing chart below shows the voltage shifts of  $V_{REF}$ ,  $V_{LX}$  and  $V_{OUT}$  in response to variation of the  $V_{IN}$  value.

Notes: Falling edge (operating) and rising edge (releasing) waveforms of  $V_{OUT}$  might be affected by the initial voltage of  $C_{OUT}$  and the output current of  $V_{OUT}$ .

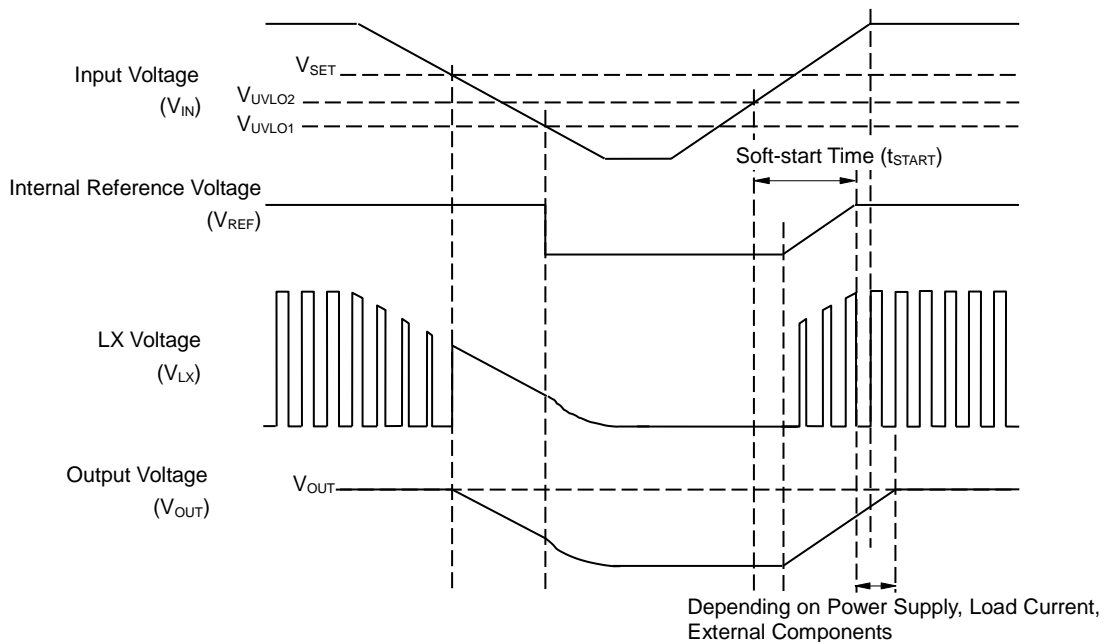

**Timing Chart with Variations in Input Voltage ( $V_{IN}$ )**

**Current limit Function**

Current limit circuit supervises the inductor current flowing through the Pch. transistor in each switching cycle. If the current exceeds the LX current limit ( $I_{LXLIM}$ , Typ.6.5 A), a Pch. transistor is turned off and the upper limit of the inductor peak current is imposed.

**Latch Type Protection (RP510Lxx1G/1H, RP510L001J/1N)**

Latch type protection circuit latches Pch. and Nch. transistors in the OFF state and stops the operation of the step-down DC/DC converter when the over current status or the output voltage ( $V_{OUT}$ ) / the feedback voltage ( $V_{FB}$ ) being dropped to the half of the setting voltage due to shorting continues for the protection delay time ( $t_{PROT}$ ). To release the latch type protection circuit, restart the device by inputting "Low" signal to the CE pin or making the supply voltage lower than  $V_{UVLO1}$ .

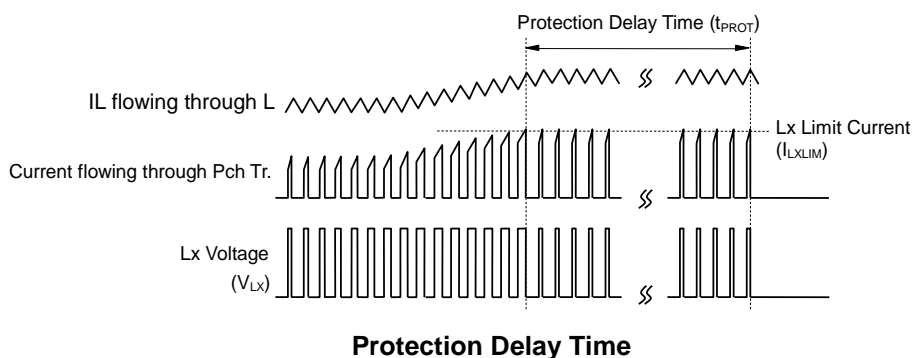

**Protection Delay Time**

The timing chart below shows the voltage shift of  $V_{CE}$ ,  $V_{Lx}$  and  $V_{OUT}$  when the device status is changed by the following orders:  $V_{IN}$  rising → stable operation → high load → CE reset → stable operation →  $V_{IN}$  falling →  $V_{IN}$  recovering (UVLO reset) → stable operation.

- (1)(2) If the overcurrent flows through the circuit or the device goes into low  $V_{OUT}$  condition due to short-circuit or other reasons, the latch type protection circuit latches Pch. and Nch. transistors in the OFF state after  $t_{PROT}$ . Then,  $V_{Lx}$  becomes "Low" and  $V_{OUT}$  turns OFF.
- (3) The latch type protection circuit is released by CE reset, which puts the device into "Low" once with the CE pin and back into "High".
- (4) The latch type protection circuit is released by UVLO reset, which makes  $V_{IN}$  lower than  $V_{UVLO1}$ .

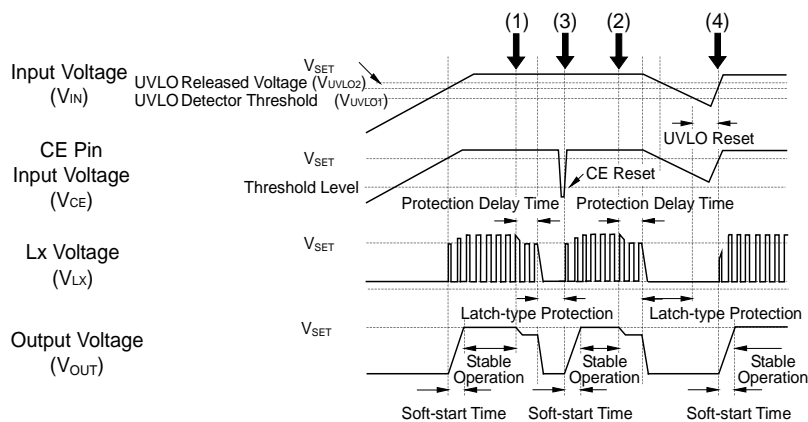

**Timing Chart**

---

## RP510L

---

No. EA-366-190515

### Foldback Protection (RP510Lxx4G/4H, RP510L004J/4N)

If the device is in a state where an overcurrent is detected during protection delay time ( $t_{\text{PROT}}$ ) or a state where the output voltage ( $V_{\text{OUT}}$ ) or the feedback voltage ( $V_{\text{FB}}$ ) becomes lower than UVD detector threshold ( $V_{\text{UVD}}$ ) over about 20  $\mu\text{sec}$  while the overcurrent is caused by an output short-circuit, the foldback protection is enabled. During the foldback protection, the inductor current is set to the upper limit of 1/2 of LX limit current ( $I_{\text{LXLIM}}$ ) and the lower limit of 0mA. During the foldback protection, the device alternately operates the following Pch. and Nch. transistor as follows: the Pch. transistor is turned ON until the inductor current reach the upper limit and the Nch. transistor is turned ON until the inductor current reach 0mA. Therefore, the switching frequency is decreased and the upper limit of the output current ( $I_{\text{OUT\_SHORT}}$ ) during the foldback protection is limited to a current value calculated by the following equation.

$$I_{\text{OUT\_SHORT}} = I_{\text{LXLIM}} / 4$$

When the short-circuit and the overcurrent states are released and the output current ( $I_{\text{OUT}}$ ) becomes less than  $I_{\text{OUT\_SHORT}}$ , the output voltage reaches the set output voltage. Then, the foldback protection is released. And also, the foldback protection is released when the device is reset by inputting CE pin to "Low" or by decreasing the input voltage to less than the UVLO detector threshold ( $V_{\text{UVLO1}}$ ). If the foldback protection occurs by the short-circuit and the overcurrent states when  $I_{\text{OUT}}$  exceed  $I_{\text{OUT\_SHORT}}$ , the device might not return to a normal state even if their states are released. Release of the foldback protection is required to reduce  $I_{\text{OUT}}$  less than  $I_{\text{OUT\_SHORT}}$  or reset the device.

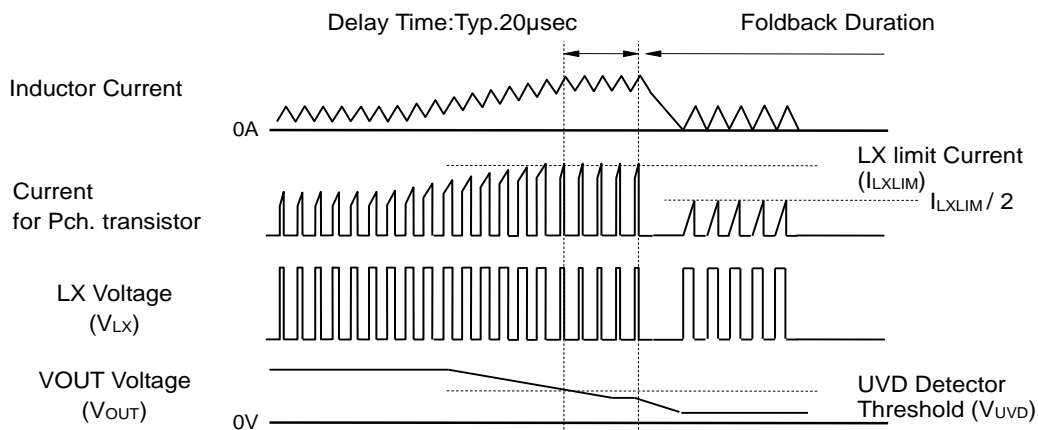

**Foldback Protection Timing Chart at Low Output Voltage**

Note: The current limit function and the overcurrent limit protection of the latch / foldback type, as described above, becomes possible to provide a high degree of safety to the device, not to secure reliability. And,  $I_{\text{LXLIM}}$  and  $t_{\text{PROT}}$  could be easily affected by self-heating or ambient environment. If the  $V_{\text{IN}}$  drops dramatically or becomes unstable due to short-circuit, protection operation and  $t_{\text{PROT}}$  could be affected.

**Reverse Current Limit Function**

The reverse current limit function supervises the current on the Nch. transistor in every switching. When an overcurrent more than the threshold current (Typ. -2.0 A) occur, the Nch. transistor is turned off to limit a lower of the inductor current. On the heavy-to-light load transient, the reverse current limit function may occur by the overcurrent. If this limit function occur, the reduction of the output voltage overshoot by reverse current will be limited.

# RP510L

No. EA-366-190515

## APPLICATION INFORMATION

Conditions: Power Good enabled, Soft-start time of 30 ms

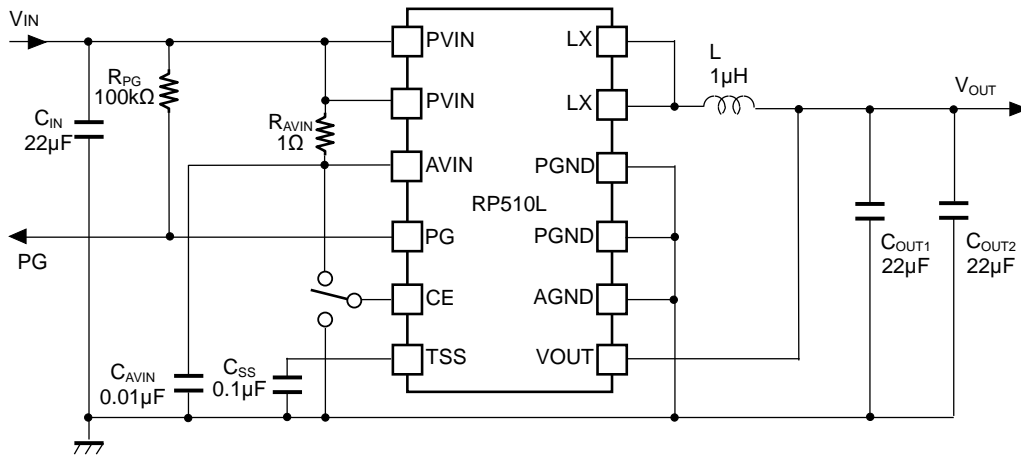

RP510Lxx1G/1H/4G/4H (Fixed Output Voltage Type) Typical Application Circuit

Conditions: Power Good disabled, Soft-start time of 150 µs

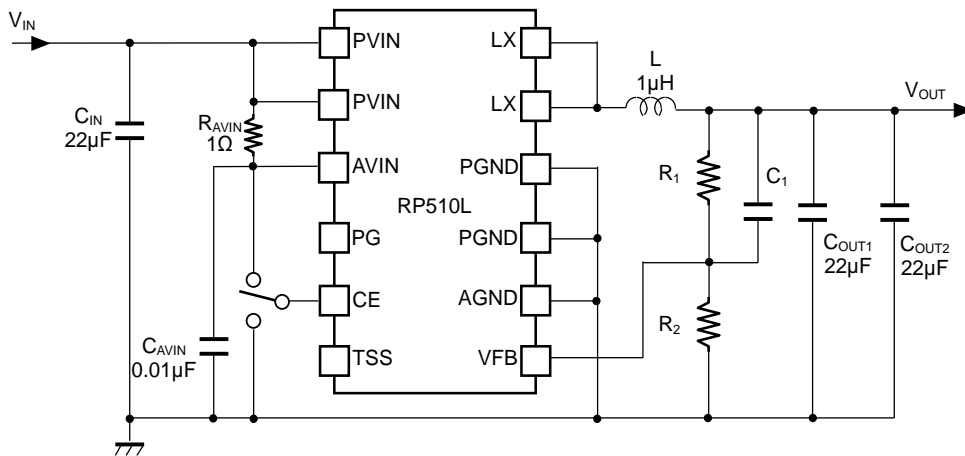

RP510L001J/1N/4J/4N (Adjustable Output Voltage Type) Typical Application Circuit

### Recommended External Components

Symbol	Descriptions
$C_{IN}$	22 µF, Ceramic Capacitor, CGA5L1X7R0J226M160AC (TDK) / C2012X6S0J226M125AB (TDK)
$C_{OUT}$	22 µF x 2, Ceramic Capacitor, CGA5L1X7R0J226M160AC (TDK) / C2012X6S0J226M125AB (TDK)
L	1.0 µH, Inductor, CLF7045NIT-1R0N-D (TDK) / SPM4012T-1R0M-LR (TDK) / VLS3012HBX-1R0M (TDK)



### Cautions in selecting external components

- Choose a low ESR ceramic capacitor. The input capacitor ( $C_{IN}$ ) between PVIN and PGND should be more than 22  $\mu$ F, and the output capacitor ( $C_{OUT}$ ) should be used by two or more parallel connection with ceramic capacitor of 22  $\mu$ F.
- The phase compensation of this device is designed according to the  $C_{OUT}$  and L values. The inductance value of an inductor should be 1.0 $\mu$ H to gain stability.
- Choose an inductor that has small DC resistance, has enough permissible current and is hard to cause magnetic saturation. If the inductance value of the inductor becomes extremely small under the load conditions, the peak current of LX may increase along with the load current. As a result, the overcurrent protection circuit may start to operate when the peak current of LX reaches to LX limit current. Therefore, choose an inductor with consideration for the value of  $I_{LXMAX}$ . See the following page of *Calculation Conditions of LX Pin Maximum Output Current ( $I_{LXMAX}$ )*.
- As for the adjustable output voltage type (RP510L001J/1N/4J/4N), the output voltage ( $V_{OUT}$ ) is adjustable by changing the resistance values of R1 and R2.

$$V_{SET}^{(1)} = V_{FB} \times (R1 + R2) / R2, (0.8 V \leq V_{SET} \leq 3.3 V)$$

If R2 are too large, the impedance of  $V_{FB}$  also become large, as a result, the device could be easily affected by noise. For this reason, R2 should be 30k $\Omega$  or less. If the operation becomes unstable dues to the high impedances, the impedances should be decreased.

C1 can be calculated by the following equation. Please use the value close to the calculation result.

$$C1 = 5 \times 10^{-7} / R2 [F]$$

The recommended component values for R1, R2, and C1 are as follows.

#### Set Output Voltage ( $V_{SET}$ ) vs. Resistor (R1, R2), Capacitor (C1)

Set Output Voltage $V_{SET}$ [V]	Resistor [k $\Omega$ ]		Capacitor [pF]
	R1	R2	C1
0.8	10	30	16
1.2	20	20	25
1.8	40	20	25
2.5	95	30	16
3.3	90	20	25

---

<sup>(1)</sup>  $V_{SET}$ : set output voltage

---

**RP510L**

---

No. EA-366-190515

**Calculation Conditions of LX Pin Maximum Output Current ( $I_{LXMAX}$ )**

The following equations explain the relationship to determine  $I_{LXMAX}$  at the ideal operation of the device in continuous mode.

$I_{RP}$  : Ripple Current P-P value

$R_{ONP} / R_{ONN}$  : ON resistance of Pch. / Nch. transistor

$R_L$  : DC resistance of the inductor

First, when the Pch. transistor is "ON", Equation 1 is satisfied.

$$V_{IN} = V_{OUT} + (R_{ONP} + R_L) \times I_{OUT} + L \times I_{RP} / t_{ON} \dots \dots \dots \text{Equation 1}$$

Second, when the Pch. transistor is "OFF" (the Nch. transistor is "ON"), Equation 2 is satisfied.

$$L \times I_{RP} / t_{OFF} = R_{ONN} \times I_{OUT} + V_{OUT} + R_L \times I_{OUT} \dots \dots \dots \text{Equation 2}$$

Put Equation 2 into Equation 1 to solve ON duty of the Pch. transistor ( $D_{ON} = t_{ON} / (t_{OFF} + t_{ON})$ ):

$$D_{ON} = (V_{OUT} + R_{ONN} \times I_{OUT} + R_L \times I_{OUT}) / (V_{IN} + R_{ONN} \times I_{OUT} - R_{ONP} \times I_{OUT}) \dots \dots \dots \text{Equation 3}$$

Ripple Current is described as follows:

$$I_{RP} = (V_{IN} - V_{OUT} - R_{ONP} \times I_{OUT} - R_L \times I_{OUT}) \times D_{ON} / f_{OSC} / L \dots \dots \dots \text{Equation 4}$$

Peak current that flows through L, and Pch. and Nch. transistors is described as follows:

$$I_{LXMAX} = I_{OUT} + I_{RP} / 2 \dots \dots \dots \text{Equation 5}$$

**Example applications: Control sequencer**

Sequencer control can be established by using the soft-start time adjustment and the power good functions of the RP510L. The following figure indicates an application circuit example with using two RP510L (DCDC1 and DCDC2).

DCDC1 starts up prior to DCDC2. After DCDC1 reaches the output voltage of typ.1.44 V ( $V_{SET} \times 0.8$ ), CE pin of DCDC2 receives "High" signal from PG pin of DCDC1, and the DCDC2's soft-start starts.

**DCDC1 (RP510L001J/1N):  $V_{IN} = 5.0\text{ V}$ ,  $V_{OUT} = 1.8\text{ V}$ ,  $t_{START} = 30\text{ ms}$ ,  $C_{SS} = 0.1\text{ }\mu\text{F}$**

**DCDC2 (RP510L001J/1N):  $V_{IN} = 5.0\text{ V}$ ,  $V_{OUT} = 1.2\text{ V}$ ,  $t_{START} = 30\text{ ms}$ ,  $C_{SS} = 0.1\text{ }\mu\text{F}$**

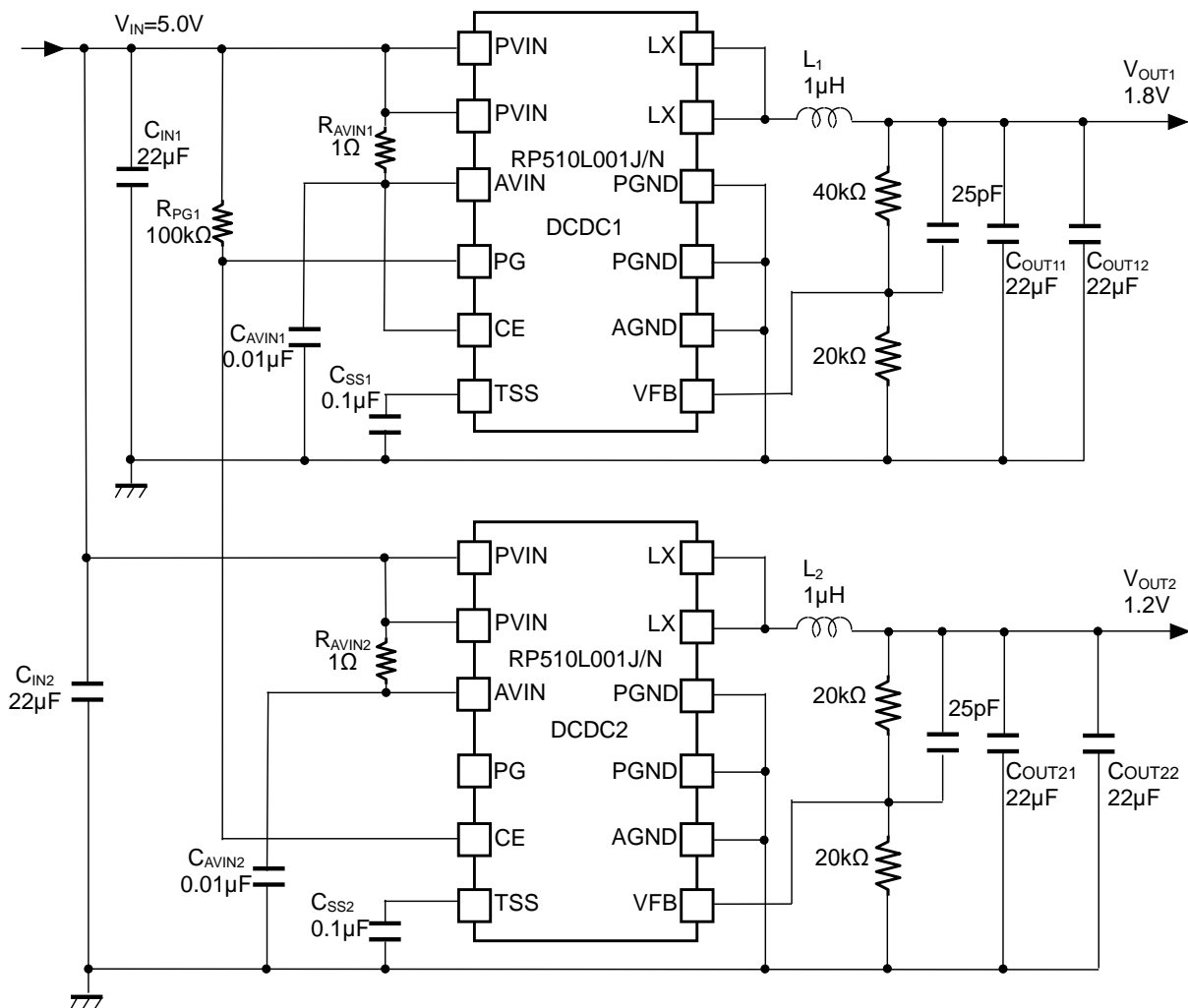

**Sequence Control Application Circuit Example**

## TECHNICAL NOTES

The performance of a power source circuit using this device is highly dependent on a peripheral circuit. A peripheral component or the device mounted on PCB should not exceed a rated voltage, a rated current or a rated power. When designing a peripheral circuit, please be fully aware of the following points.

- AGND and PGND must be wired to the GND plane when mounting on boards.
- AVIN must be connected to between an input capacitor ( $C_{IN}$ ) and PVIN via a low-pass filter (Recommended LPF: 1  $\Omega$ , 10 nF). Place a capacitor between AVIN and AGND as close as possible to the IC.
- Set the external components as close as possible to the IC and minimize the wiring between the components and the IC. Especially, place  $C_{IN}$  as close as possible to PVIN pin and PGND.
- Use the VIN and the GND lines as wide and short as possible to make low impedance, since noise pickup or unstable operation occurs when their impedance are too high.
- The VIN line, the GND line, the  $V_{OUT}$  line, an inductor, and  $L_x$  should make special considerations for the large switching current flows.
- For the feedback of output voltage, the wiring to the VOUT pin (RP510Lxx1G/1H/4G/4H) or to a resistor for setting output voltage (R1) (RP510L001J/1N/4J/4N) must be taken from the connection with the output capacitor, and also the wiring should be separated from the wiring between the output capacitor and Load.
- Overcurrent protection circuit and latch / foldback type protection circuit may be affected by self-heating or power dissipation environment.
- When not using the soft-start time adjustment, always make TSS pin open.
- When not using the power good function, PG pin should be Open or connected to GND.

PCB Layout Example

RP510L001J/1N/4J/4N (Adjustable Output Voltage Type)

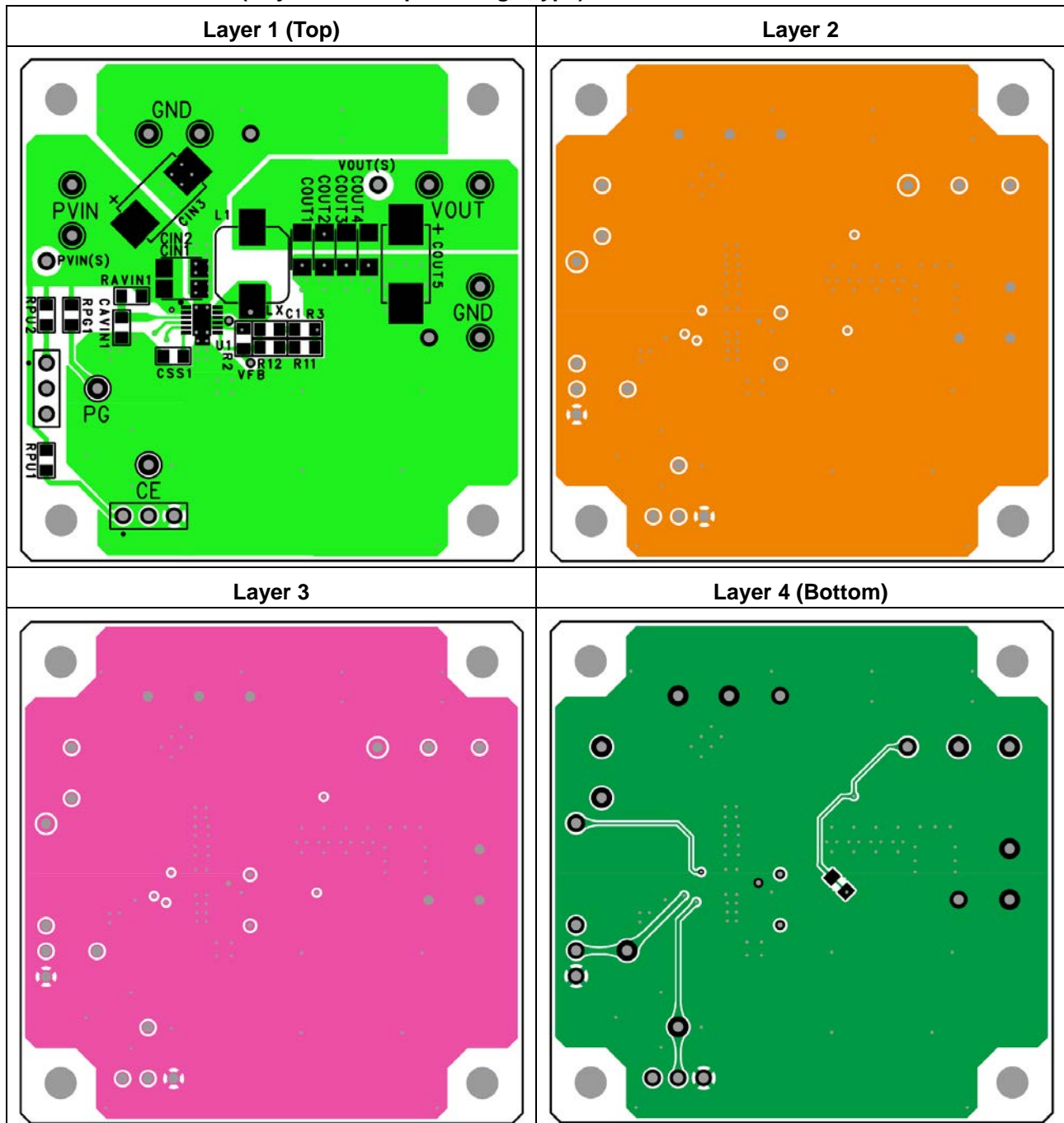

\* The LPF between PVIN and AVIN is recommended to place to the layer 1 (Top) is recommended.

\*\* R11 and R12 are arranged as a substitute for R1 so that two resistors can be connected in series.

# RP510L

No. EA-366-190515

## RP510Lxx1G/1H/4G/4H (Fixed Output Voltage Type)

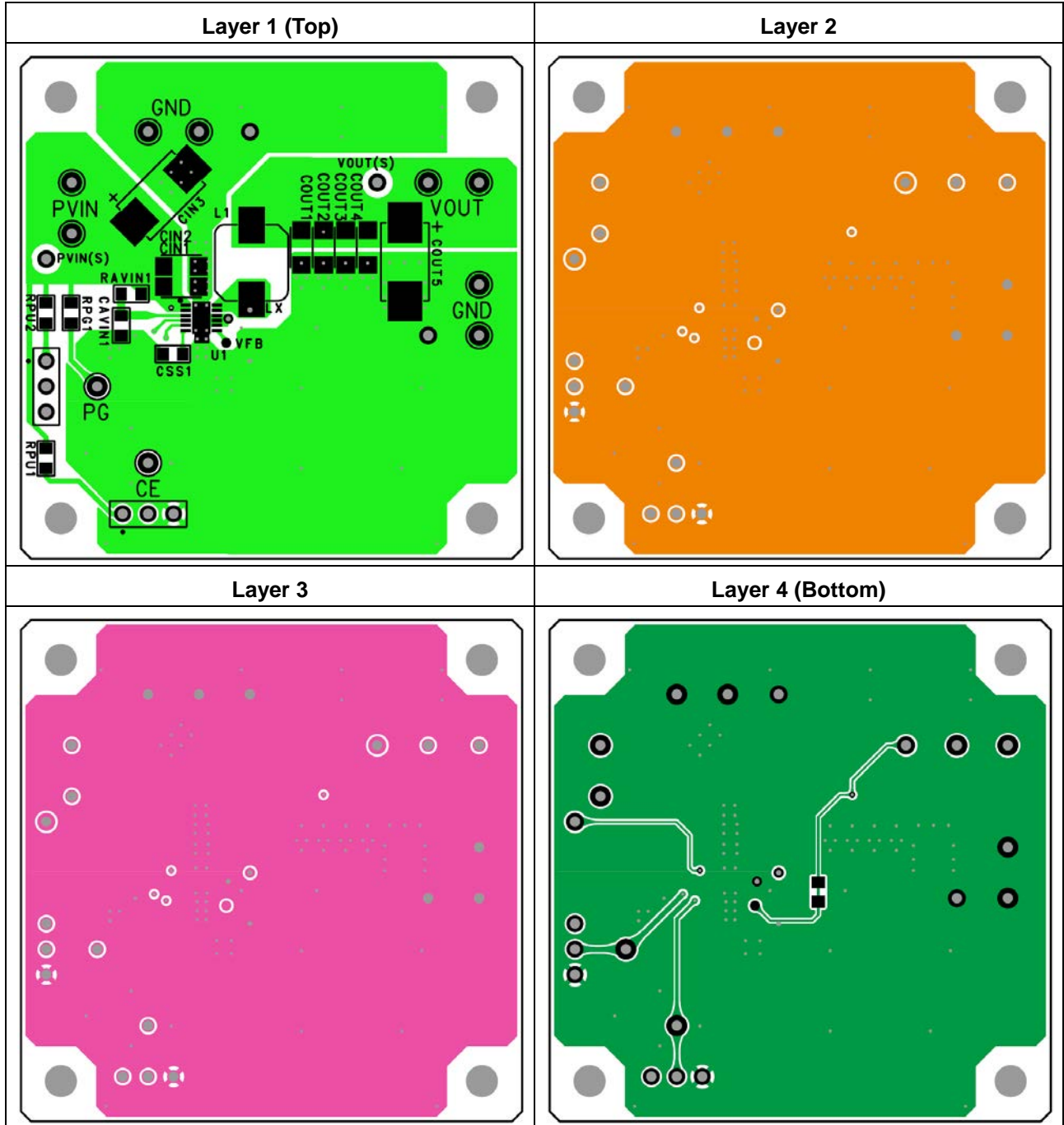

\* LPF between PVIN and AVIN is recommended to place to Layer 1 (Top) is recommended.

## TYPICAL CHARACTERISTICS

Typical Characteristics are intended to be used as reference data, they are not guaranteed.

### 1) Output Voltage vs. Output Current

$V_{OUT} = 0.8\text{ V}$

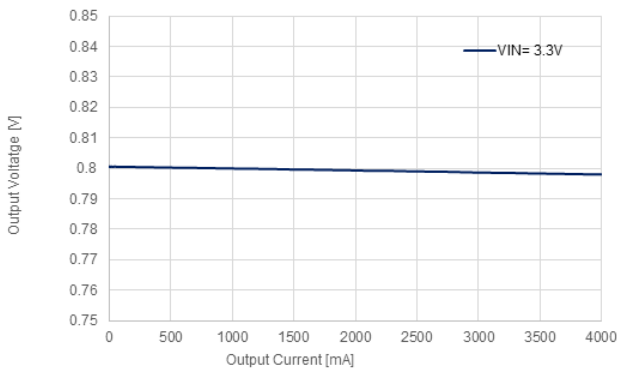

$V_{OUT} = 1.2\text{ V}$

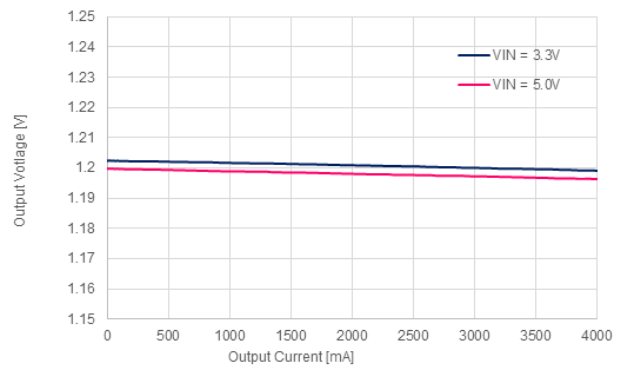

$V_{OUT} = 3.3\text{ V}$

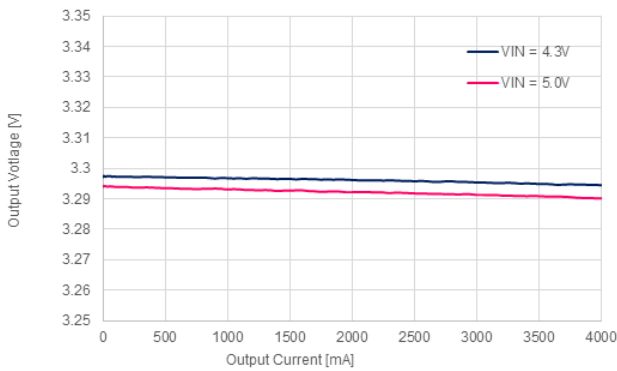

### 2) Output Voltage vs. Input Voltage

$V_{OUT} = 1.2\text{ V}$

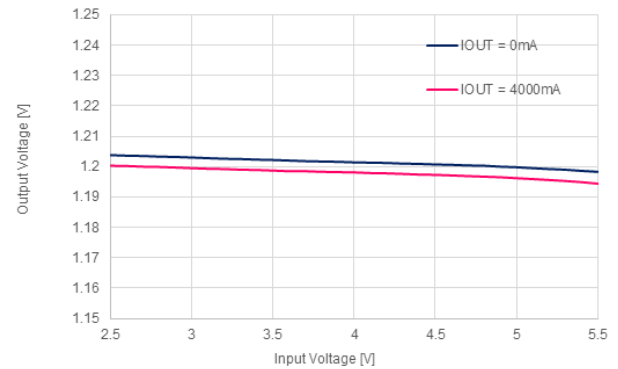

### 3) Feedback Voltage vs. Temperature

RP510L001J/1N/4J/4N/

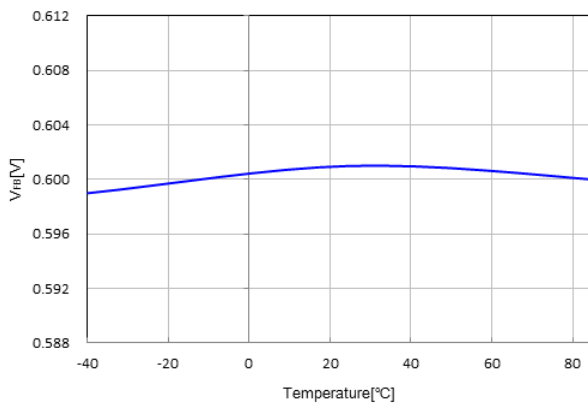

### 4) Output Voltage vs. Temperature

RP510Lxx1G/1H/4G/4H

$V_{OUT} = 1.2\text{ V}$

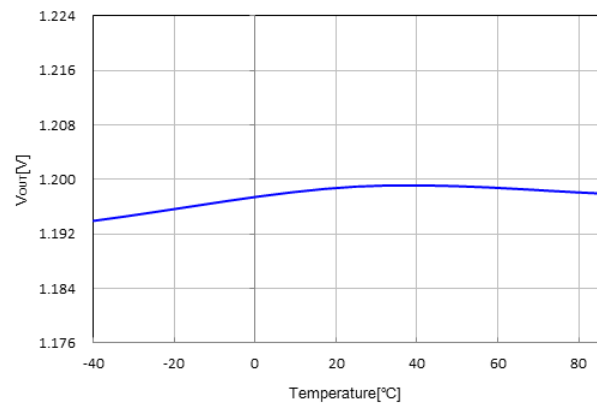

**5) Efficiency vs. Output Current**

$V_{OUT} = 0.8\text{ V}$

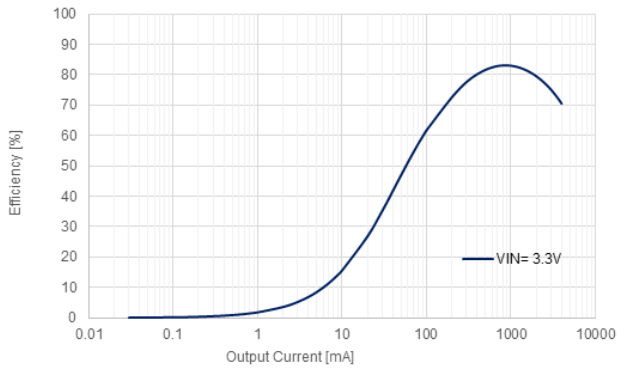

$V_{OUT} = 1.2\text{ V}$

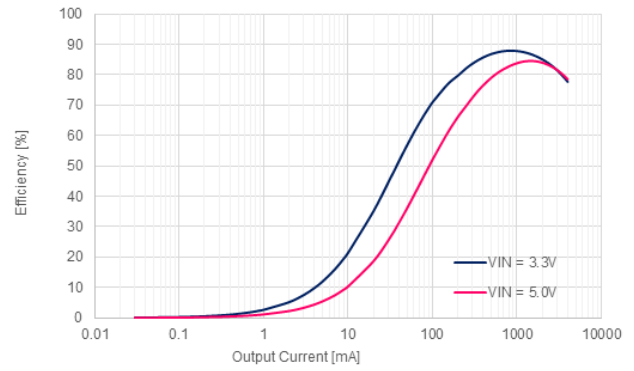

$V_{OUT} = 3.3\text{ V}$

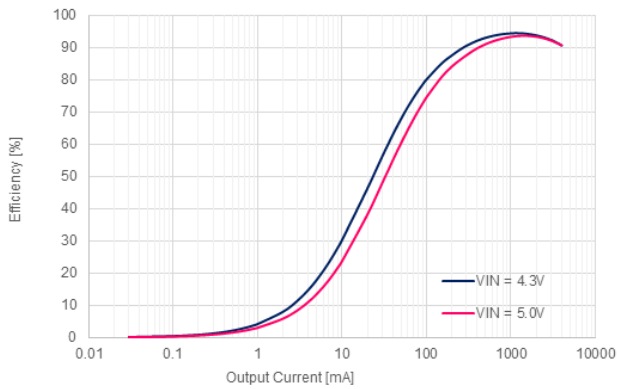

**6) Current Consumption vs. Temperature**

$V_{IN} = 5.5\text{ V}$

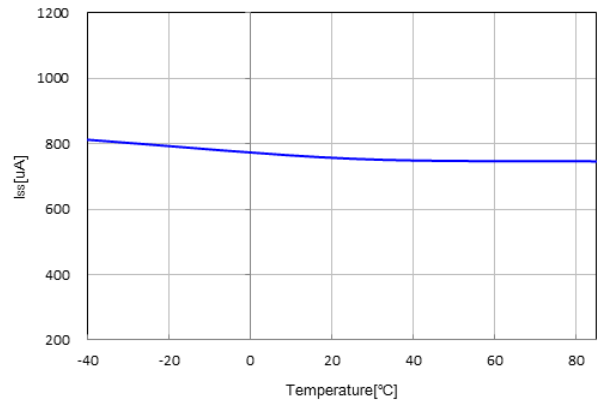

**7) Current Consumption vs. Input Voltage**

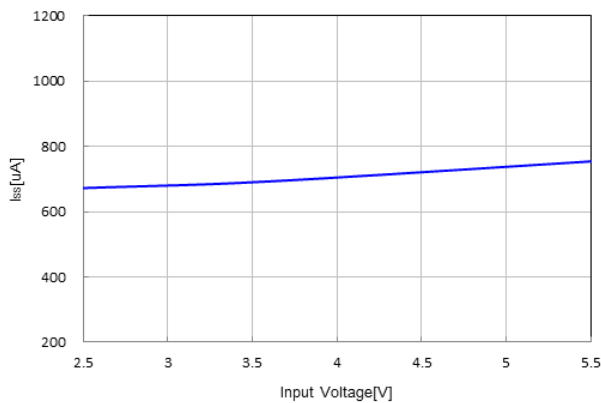



**8) Output Voltage Waveform**

$V_{OUT} = 1.2\text{ V}$ ,  $I_{OUT} = 0\text{mA}$

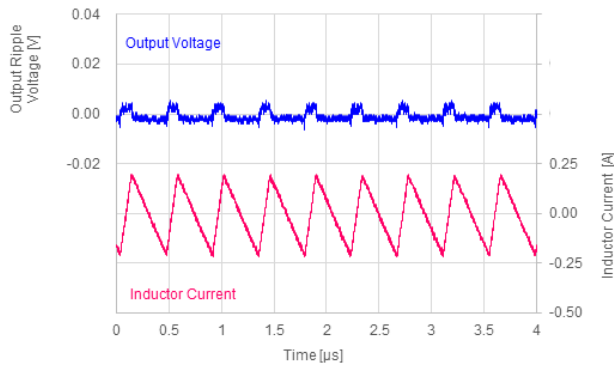

$V_{OUT} = 1.2\text{ V}$ ,  $I_{OUT} = 4000\text{mA}$

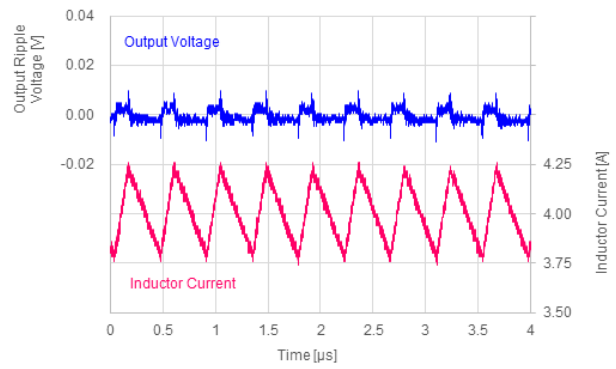

**9) Oscillation Frequency vs. Temperature**

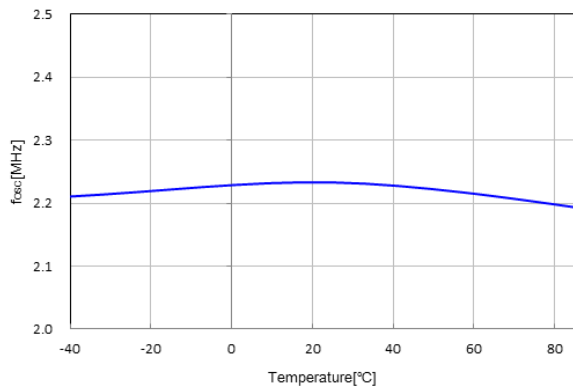

**10) Oscillation Frequency vs. Input Voltage**

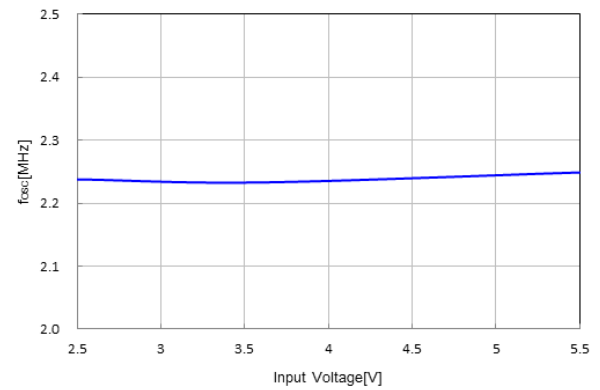

**11) Soft-start time vs. Temperature**

$C_{SS} = \text{open}$

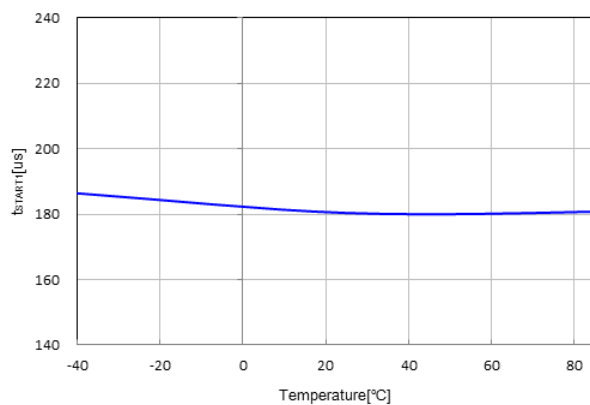

$C_{SS} = 0.1\mu\text{F}$

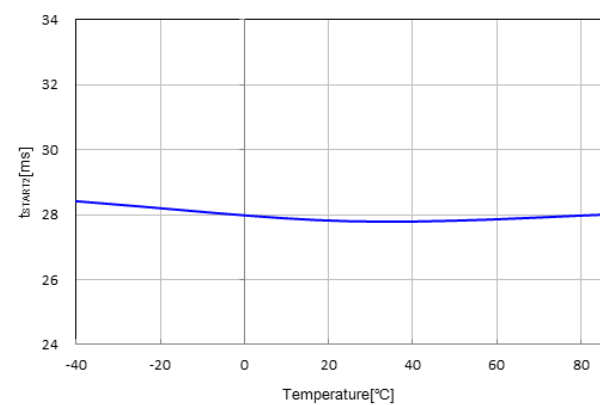

---

# RP510L

---

No. EA-366-190515

## 12) UVLO vs. Temperature

UVLO detection voltage

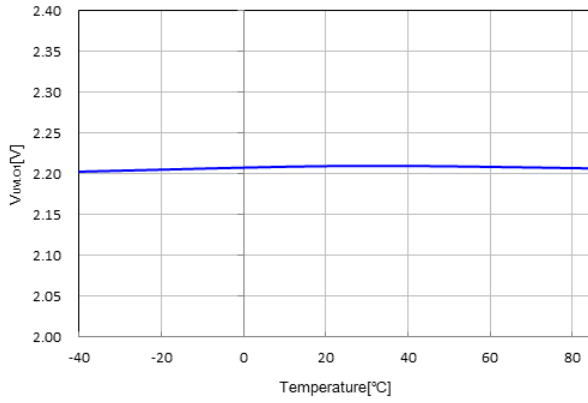

UVLO release voltage

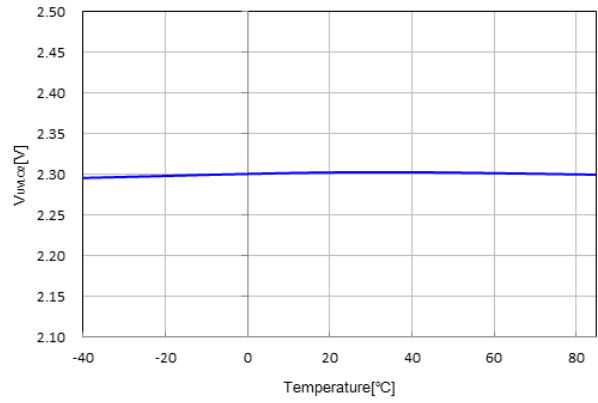

## 13) CE Input Voltage vs. Temperature

CE "H" input voltage

$V_{IN} = 5.5$  V

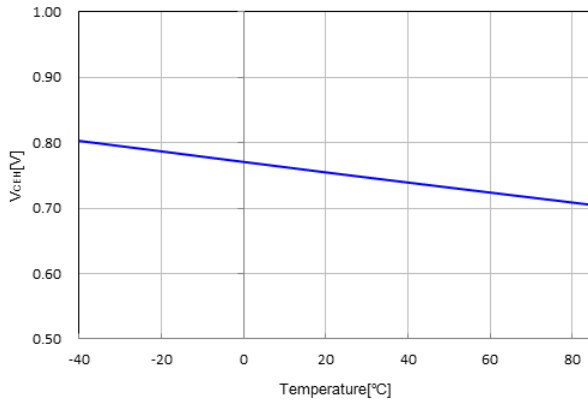

CE "L" input voltage

$V_{IN} = 2.5$  V

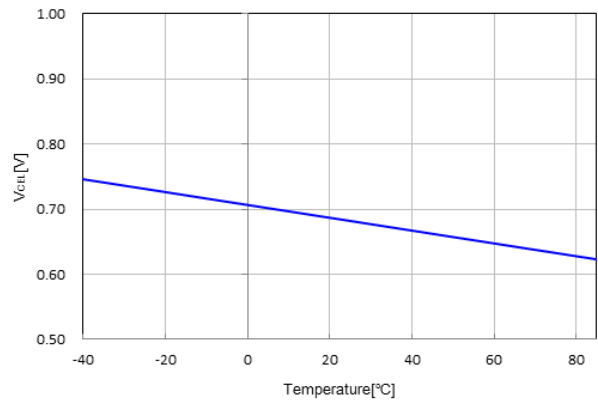

## 14) LX Limit Current vs. Temperature

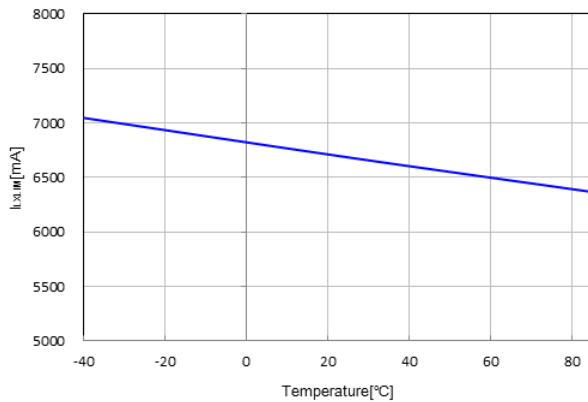

**15) PG Detection Voltage vs. Temperature**  
Over Voltage Detection

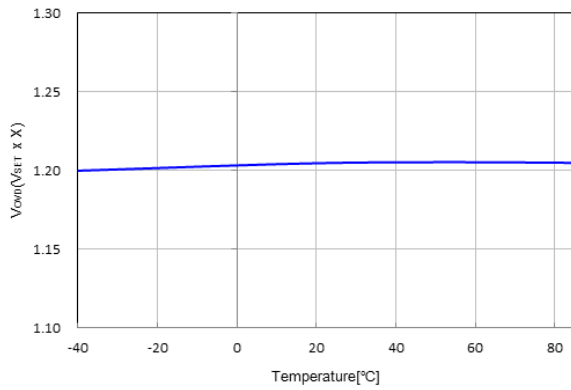

Under Voltage Detection

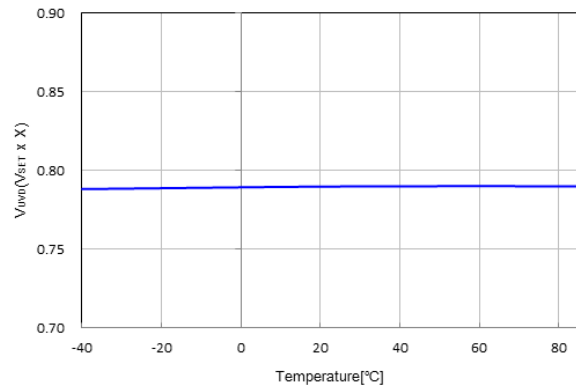

**16) Soft-start Waveform**  
 $V_{OUT} = 1.2\text{ V}$ ,  $C_{SS} = \text{open}$

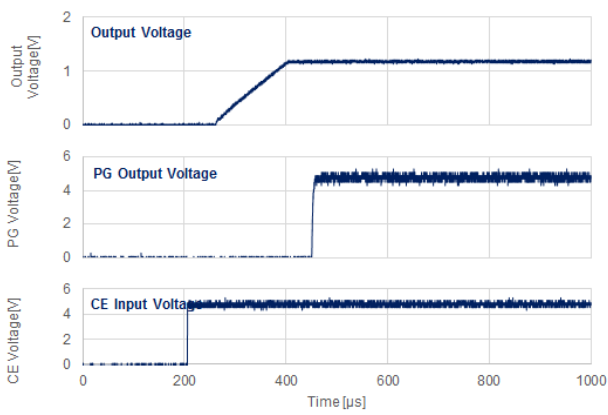

$V_{OUT} = 1.2\text{ V}$ ,  $C_{SS} = 0.1\mu\text{F}$

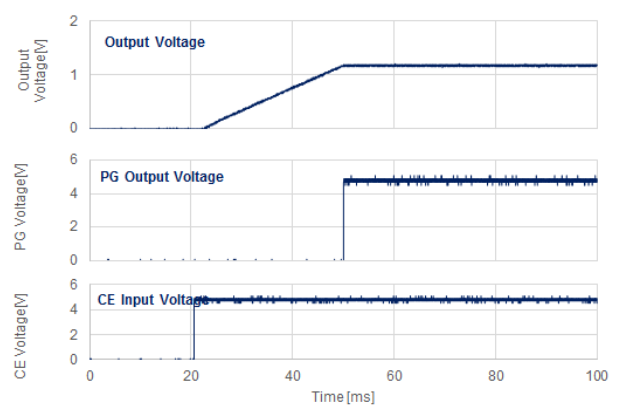

**17) Load Transient Response**  
 $V_{IN} = 3.3\text{ V}$ ,  $V_{OUT} = 1.2\text{ V}$   
 $I_{OUT} = 0.5\text{ A} \leftrightarrow 3.5\text{ A}$

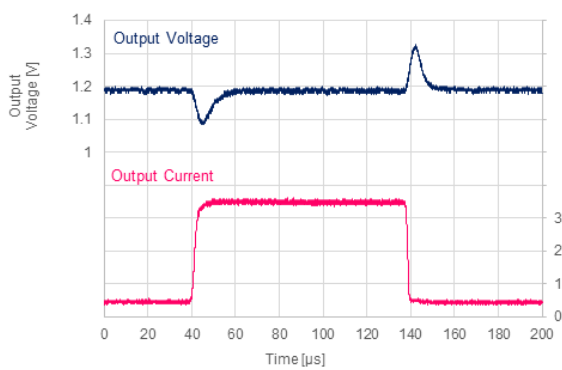

$V_{IN} = 5.0\text{ V}$ ,  $V_{OUT} = 1.2\text{ V}$   
 $I_{OUT} = 0.5\text{ A} \leftrightarrow 3.5\text{ A}$

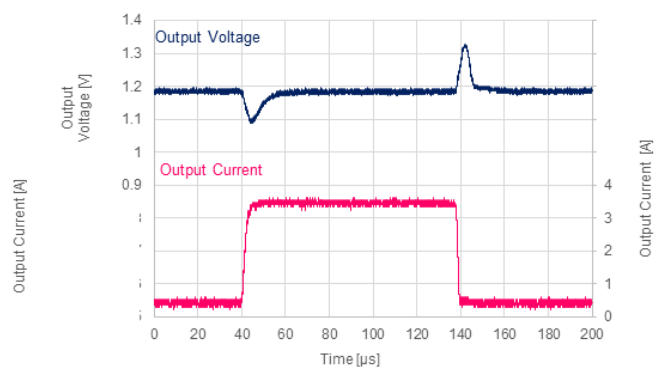

---

# RP510L

---

No. EA-366-190515

## 18) Output Short-circuit Waveform

RP510Lxx1G/1H/1J/1N (Latch Type)

$V_{IN} = 5.0\text{ V}$ ,  $V_{OUT} = 0.8\text{ V}$

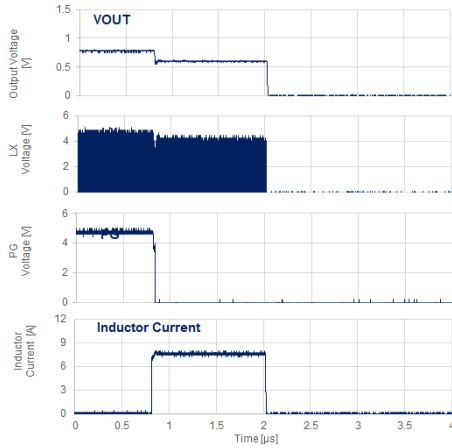

RP510Lxx4G/4H/4J/4N (Foldback Type)

$V_{IN} = 5.0\text{ V}$ ,  $V_{OUT} = 0.8\text{ V}$

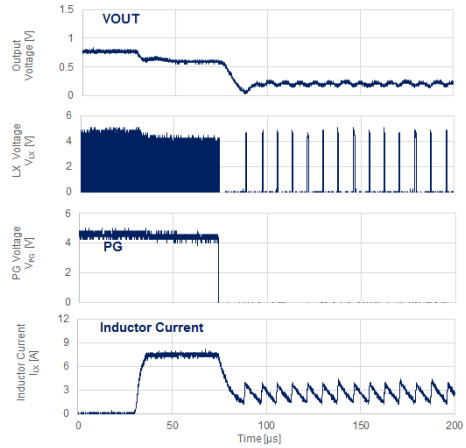

## 19) Output Short-circuit Release Waveform

RP510Lxx4G/4H/4J/4N (Foldback Type)

$V_{IN} = 5.0\text{ V}$ ,  $V_{OUT} = 0.8\text{ V}$

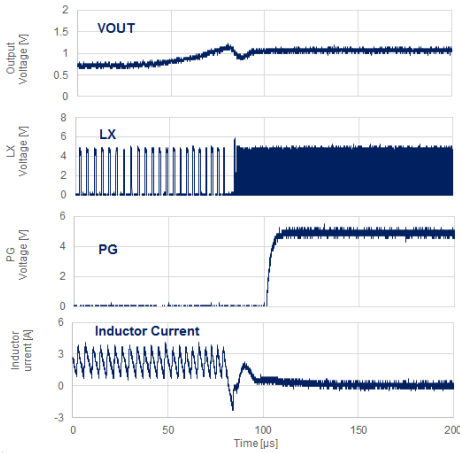

The power dissipation of the package is dependent on PCB material, layout, and environmental conditions. The following measurement conditions are based on JEDEC STD. 51-7.

**Measurement Conditions**

Item	Measurement Conditions
Environment	Mounting on Board (Wind Velocity = 0 m/s)
Board Material	Glass Cloth Epoxy Plastic (Four-Layer Board)
Board Dimensions	76.2 mm × 114.3 mm × 0.8 mm
Copper Ratio	Outer Layer (First Layer): Less than 95% of 50 mm Square Inner Layers (Second and Third Layers): Approx. 100% of 50 mm Square Outer Layer (Fourth Layer): Approx. 100% of 50 mm Square
Through-holes	φ 0.3 mm × 32 pcs

**Measurement Result**

(Ta = 25°C, Tjmax = 125°C)

Item	Measurement Result
Power Dissipation	3400 mW
Thermal Resistance (θja)	θja = 29°C/W
Thermal Characterization Parameter (ψjt)	ψjt = 3.1°C/W

θja: Junction-to-Ambient Thermal Resistance

ψjt: Junction-to-Top Thermal Characterization Parameter

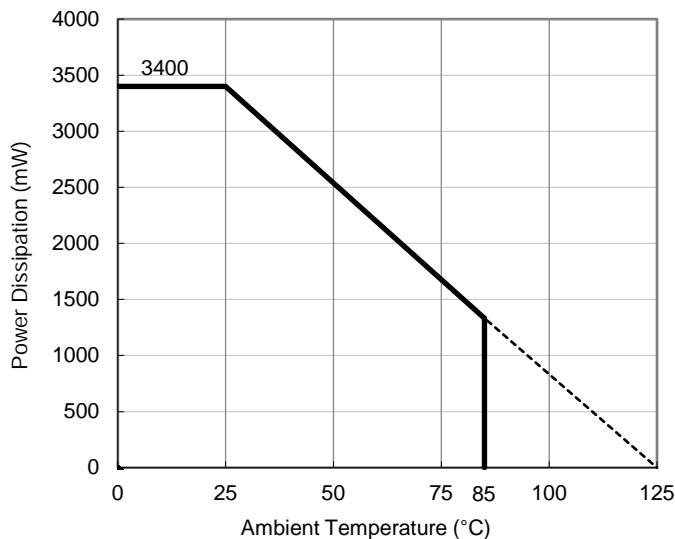

**Power Dissipation vs. Ambient Temperature**

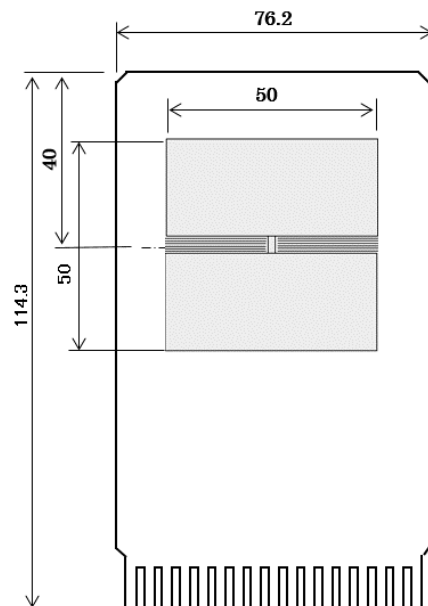

**Measurement Board Pattern**

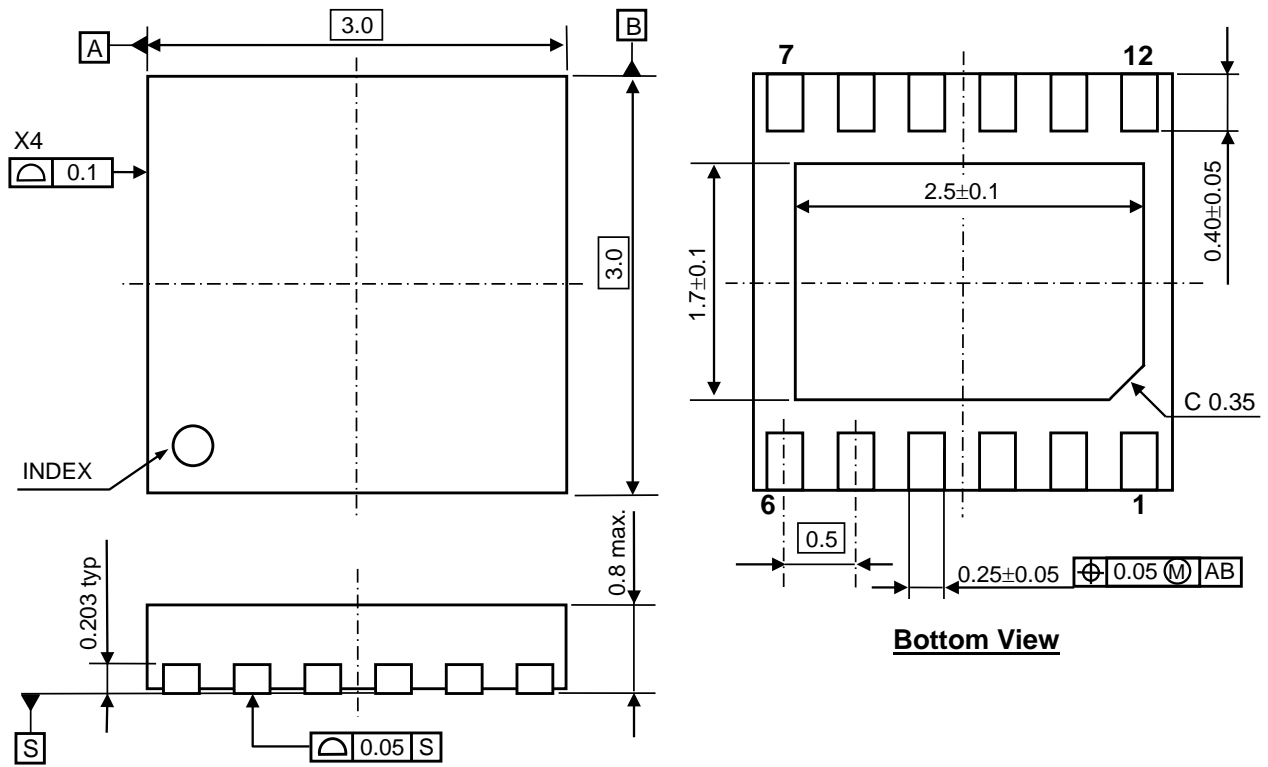

DFN3030-12 Package Dimensions (Unit: mm)



1. The products and the product specifications described in this document are subject to change or discontinuation of production without notice for reasons such as improvement. Therefore, before deciding to use the products, please refer to our sales representatives for the latest information thereon.
2. The materials in this document may not be copied or otherwise reproduced in whole or in part without prior written consent of our company.
3. Please be sure to take any necessary formalities under relevant laws or regulations before exporting or otherwise taking out of your country the products or the technical information described herein.
4. The technical information described in this document shows typical characteristics of and example application circuits for the products. The release of such information is not to be construed as a warranty of or a grant of license under our company's or any third party's intellectual property rights or any other rights.
5. The products listed in this document are intended and designed for use as general electronic components in standard applications (office equipment, telecommunication equipment, measuring instruments, consumer electronic products, amusement equipment etc.). Those customers intending to use a product in an application requiring extreme quality and reliability, for example, in a highly specific application where the failure or misoperation of the product could result in human injury or death (aircraft, spacevehicle, nuclear reactor control system, traffic control system, automotive and transportation equipment, combustion equipment, safety devices, life support system etc.) should first contact us.
6. We are making our continuous effort to improve the quality and reliability of our products, but semiconductor products are likely to fail with certain probability. In order to prevent any injury to persons or damages to property resulting from such failure, customers should be careful enough to incorporate safety measures in their design, such as redundancy feature, fire containment feature and fail-safe feature. We do not assume any liability or responsibility for any loss or damage arising from misuse or inappropriate use of the products.
7. Anti-radiation design is not implemented in the products described in this document.
8. The X-ray exposure can influence functions and characteristics of the products. Confirm the product functions and characteristics in the evaluation stage.
9. WLCSP products should be used in light shielded environments. The light exposure can influence functions and characteristics of the products under operation or storage.
10. There can be variation in the marking when different AOI (Automated Optical Inspection) equipment is used. In the case of recognizing the marking characteristic with AOI, please contact our sales or our distributor before attempting to use AOI.
11. Please contact our sales representatives should you have any questions or comments concerning the products or the technical information.



**Nisshinbo Micro Devices Inc.**

**Official website**

<https://www.nisshinbo-microdevices.co.jp/en/>

**Purchase information**

<https://www.nisshinbo-microdevices.co.jp/en/buy/>

