

## 1.5 A PWM/VFM Buck-Boost DC/DC Converter with Synchronous Rectifier

No. EA-353-190507

### OVERVIEW

The RP602x is a 6.5 V (Max. rating) buck-boost DC/DC converter with synchronous rectifier. This device is ideally suited for industrial or OA equipment that require constant voltage even when low-input voltage (Min. 2.3 V). Since operating with switching frequency of 2.6 MHz, this device can realize a high-speed response with a small coil and maintain a high-efficiency at low input voltage.

### KEY BENEFITS

- Realize a high-efficiency at low input voltage.
- Provide output voltage of 2.7 to 4.2 V corresponding to input voltage of 2.3 to 5.5 V.

### KEY SPECIFICATIONS

- Input Voltage Range: 2.3 V to 5.5 V
- Output Voltage Range: 2.7 V to 4.2 V (0.1V step)
- Output Voltage Accuracy:  $\pm 1.5\%$
- Line Regulation: Typ. 0.5%, PWM mode
- Load Regulation: Typ. 0.1%,  
( $I_{OUT} = 0$  to 500 mA, PWM mode)
- Maximum Output Current: Typ. 1.5 A,  
( $PV_{IN} = 3$  V,  $VO_{UT} = 3.3$  V)
- Maximum Burst Current: Typ. 2.7 A,  
( $PV_{IN} = 3$  V,  $VO_{UT} = 3.3$  V, Duty=10%,  $t = 2.0$  ms)
- Overcurrent Limit Protection: Typ. 4.2 A
- Oscillator Frequency: Typ. 2.6 MHz
- Built-in Driver ON Resistance:  
Typ. Pch. 80 m $\Omega$ , Nch. 80 m $\Omega$
- Operating Quiescent Current: Typ. 27.5  $\mu$ A,  
(VFM mode, Non-switching)
- UVLO Detector Threshold: Typ. 2.0 V
- Soft-start Time: Typ. 1.0 ms
- Thermal Shutdown Temperature: Typ. 150 $^{\circ}$ C
- Protection Feature: Overvoltage, Overcurrent

### TYPICAL CHARACTERISTICS

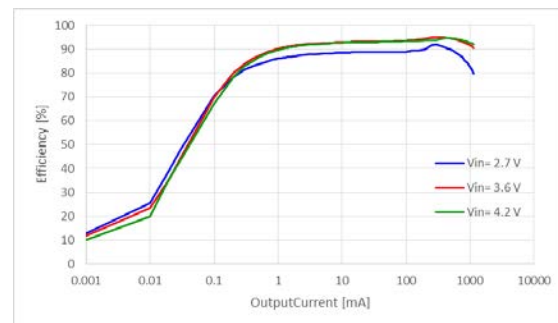

Efficiency Characteristics (RP602Z330x, MODE = H)

### TYPICAL APPLICATION

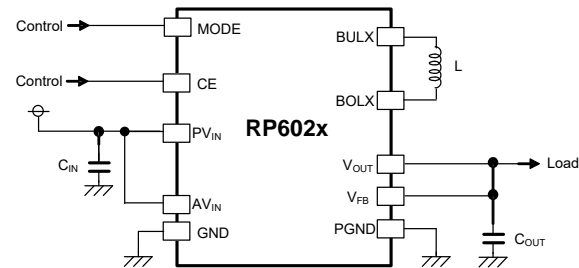

### PACKAGE

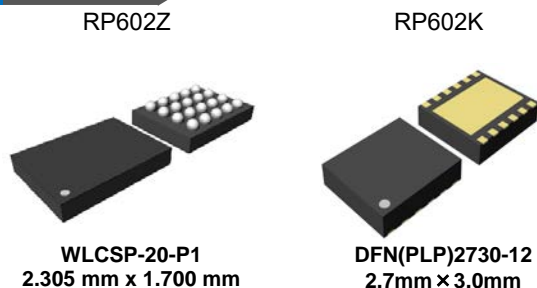

### OPTIONAL FUNCTION

The following functions are user-selectable options.

Code	Auto-discharge Function	Latch Protection	Reset Protection
A/E	Yes	Yes	No
B/F	No	Yes	No
C/G	Yes	No	Yes
D/H	No	No	Yes

### APPLICATIONS

- Power source for portable equipment such as laptops, PDAs, DSCs, cellular phones, and smartphones
- Power source for Li-ion battery-used equipment

---

**RP602x**

---

No. JA-353-190507

**SELECTION GUIDE****Selection Guide**

Product Name	Package	Quantity per Reel	Pb Free	Halogen Free
RP602Zxxx\$-E2-F	WLCSP-20-P1	5,000 pcs	Yes	Yes
RP602Kxxx#-TR	DFN(PLP)2730-12	5,000 pcs	Yes	Yes

xxx: Specify the set output voltage ( $V_{SET}$ ) within the range of 2.7 V to 4.2 V in 0.1 V <sup>(1)</sup> steps.

\$: Specify the combination of the auto-discharge option and the protection function option.

Symbol	Auto-discharge Function	Latch-type Protection	Reset-type Protection	Short-circuit Protection
A	Yes	Yes	No	Yes
B	No	Yes	No	Yes
C	Yes	No	Yes	Yes
D	No	No	Yes	Yes

#: Specify the combination of the auto-discharge option and the protection function option.

Symbol	Auto-discharge Function	Latch-type Protection	Reset-type Protection	Short-circuit Protection
E	Yes	Yes	No	Yes
F	No	Yes	No	Yes
G	Yes	No	Yes	Yes
H	No	No	Yes	Yes

---

<sup>(1)</sup> 0.05 V step is also available as a custom code.

---

**BLOCK DIAGRAM**

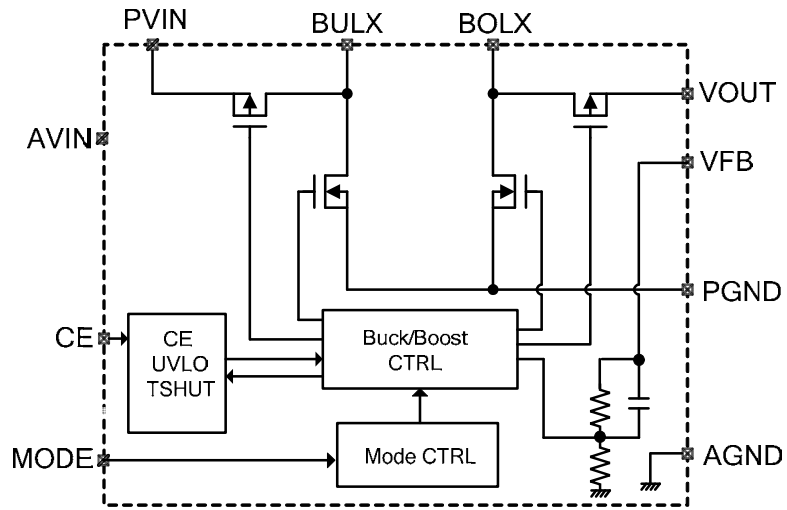

**RP602x Block Diagram**

## RP602x

No. JA-353-190507

## PIN DESCRIPTION

### RP602Z Pin Description

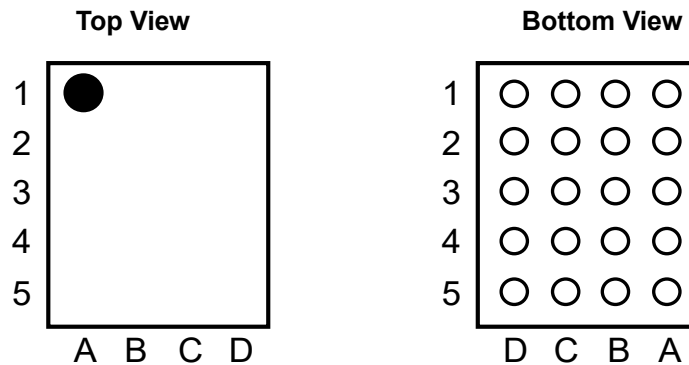

WLCSP-20-P1 Pin Configuration

Pin No.	Symbol	Pin Description
A5, B5, C5	VOUT <sup>(1)</sup>	Output Voltage Pin
A4, B4, C4	BOLX <sup>(1)</sup>	Boost Switching Output Pin
A3, B3, C3	PGND <sup>(2)</sup>	Power GND Pin
A2, B2, C2	BULX <sup>(1)</sup>	Buck Switching Output Pin
A1, B1, C1	PVIN <sup>(1)</sup>	Power Input Voltage Pin
D1	AVIN <sup>(1)</sup>	Analog Power Input Voltage Pin
D2	CE	Chip Enable Pin, Active-high
D3	MODE	Mode Control Pin, Forced PWM Control: L, PWM/VFM Auto Switching Control: H
D4	AGND <sup>(2)</sup>	Analog GND Pin
D5	VFB	Output Voltage Feedback Pin

### Pin Truth Table

CE Pin	MODE Pin <sup>(3)</sup>	Operation
L	-	OFF
H	H	PWM/ VFM Auto Switching Control Mode
	L	Forced PWM Control Mode

<sup>(1)</sup> The pin numbers sharing the same pin symbol must be connected together: A4, B4, and C4 of the BOLX pin, A2, B2, and C2 of the BULX pin, A5, B5, and C5 of the VOUT pin. D1 of the AVIN pin and A1, B1, and C1 of the PVIN pin must be connected together.

<sup>(2)</sup> D4 of the AGND pin and A3, B3, and C3 of the PGND pin must be connected to the ground.

<sup>(3)</sup> The logic to the MODE pin should not be changed while CE = "H".

RP602K Pin Description

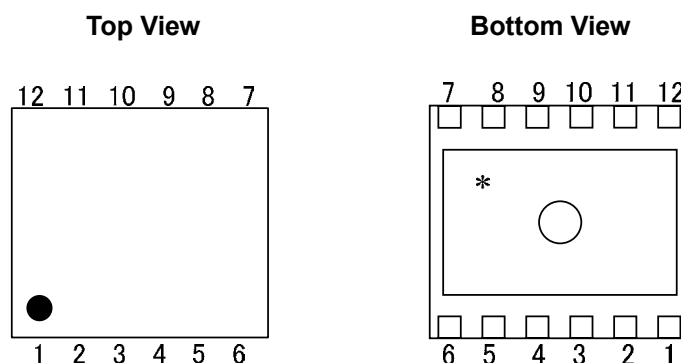

DFN(PLP)2730-12 Pin Configuration

Pin No.	Symbol	Pin Description
1	AVIN <sup>(1)</sup>	Analog Power Input Voltage Pin
2	CE	Chip Enable Pin, Active-high
3	MODE	Mode Control Pin, Forced PWM Control: L, PWM/VFM Auto Switching Control: H
4	NC	No Connection
5	AGND <sup>(2)</sup>	Analog GND Pin
6	VFB	Output Voltage Feedback Pin
7	VOUT	Output Voltage Pin
8	BOLX	Boost Switching Output Pin
9,10	PGND <sup>(2)</sup>	Power GND Pin
11	BULX	Buck Switching Output Pin
12	PVIN <sup>(1)</sup>	Power Input Voltage Pin

\* The tab on the bottom of the package must be connected to the ground plane on the board to enhance thermal performance.

Pin Truth Table

CE Pin	MODE Pin <sup>(3)</sup>	Operation
L	-	OFF
H	H	PWM/ VFM Auto Switching Control Mode
	L	Forced PWM Control Mode

<sup>(1)</sup> The AVIN pin and the PVIN pin must be connected together.

<sup>(2)</sup> The AGND pin and the PGND pin must be connected to the ground.

<sup>(3)</sup> The logic to the MODE pin should not be changed while CE = "H".

## RP602x

No. JA-353-190507

## ABSOLUTE MAXIMUM RATINGS

### Absolute Maximum Ratings

(AGND = PGND = 0 V)

Symbol	Item		Rating	Unit
$V_{IN}$	AVIN/ PVIN Pin Voltage		-0.3 to 6.5	V
$V_{BULX}$	BULX Pin Voltage		-0.3 to $V_{IN} + 0.3$	V
$V_{BOLX}$	BOLX Pin Voltage		-0.3 to $V_{OUT} + 0.3$	V
$V_{CE}$	CE Pin Voltage		-0.3 to 6.5	V
$V_{MODE}$	MODE Pin Voltage		-0.3 to 6.5	V
$V_{OUT}$	VOUT Pin Voltage		-0.3 to 6.5	V
$V_{FB}$	VFB Pin Voltage		-0.3 to 6.5	V
$I_{LX}$	BULX/ BOLX Pin Output Current		4.2	A
$P_D$	Power Dissipation <sup>(1)</sup>	WLCSP-20-P1 (JEDEC STD.51-9 )	1400	mW
		DFN(PLP)2730-12 (JEDEC STD.51-7 )	3100	
$T_j$	Junction Temperature Range		-40 to 125	°C
$T_{stg}$	Storage Temperature Range		-55 to 125	°C

### ABSOLUTE MAXIMUM RATINGS

Electronic and mechanical stress momentarily exceeded absolute maximum ratings may cause permanent damage and may degrade the life time and safety for both device and system using the device in the field.  
The functional operation at or over these absolute maximum ratings are not assured.

## RECOMMENDED OPERATING CONDITIONS

Symbol	Item	Rating	Unit
$V_{IN}$	Input Voltage	2.3 to 5.5	V
$T_a$	Operating Temperature Range	-40 to 85	°C

### RECOMMENDED OPERATING CONDITIONS

All of electronic equipment should be designed that the mounted semiconductor devices operate within the recommended operating conditions. The semiconductor devices cannot operate normally over the recommended operating conditions, even if they are used over such ratings by momentary electronic noise or surge. And the semiconductor devices may receive serious damage when they continue to operate over the recommended operating conditions.

<sup>(1)</sup> Refer to *POWER DISSIPATION* for detailed information.

## ELECTRICAL CHARACTERISTICS

Open-loop Measurement GND = 0 V, unless otherwise noted.

### RP602Z Electrical Characteristics

(Ta = 25°C)

Symbol	Item	Conditions	Min.	Typ.	Max.	Unit
I <sub>DD</sub>	Power Current	V <sub>IN</sub> = 5.5 V, V <sub>MODE</sub> = 5.5V		27.5	60	μA
		V <sub>OUT</sub> = 4.2 V, V <sub>MODE</sub> = 0 V		1000	1400	
I <sub>STANDBY</sub>	Standby Current	V <sub>IN</sub> = 5.5 V, V <sub>CE</sub> = 0 V		0.1	5.0	μA
V <sub>OUT</sub>	Output Voltage	V <sub>IN</sub> = 3.6 V	x0.985		x1.015	V
Δ V <sub>OUT</sub> / ΔTa	Output Voltage Temperature Coefficient	-40°C ≤ Ta ≤ 85°C		±50		ppm/°C
V <sub>OVP</sub>	OVP Detection Voltage	V <sub>IN</sub> = 3.6 V, Rising	4.5	5.0	5.5	V
	OVP Release Voltage	V <sub>IN</sub> = 3.6 V, Falling	4.3	4.8	5.3	V
f <sub>OSC</sub>	Switching Frequency	V <sub>IN</sub> = 3.6 V	2.4	2.6	2.9	MHz
I <sub>LIMHS</sub>	BULX Current Limit <sup>(1)</sup>	V <sub>IN</sub> = 3.6 V	3.7	4.2		A
R <sub>ON</sub>	High & Low Switch On-resistance	V <sub>IN</sub> = 3.6 V		80		mΩ
R <sub>DIS</sub>	On-resistance of Discharge Tr. (RP602ZxxxA/C)	V <sub>IN</sub> = 3.6 V, V <sub>CE</sub> = 0 V		80		Ω
I <sub>FBH</sub>	V <sub>FB</sub> Input Current, High	V <sub>IN</sub> = 5.5 V, V <sub>CE</sub> = 0 V V <sub>FB</sub> = 5.5V			1	μA
I <sub>FBL</sub>	V <sub>FB</sub> Input Current, Low	V <sub>IN</sub> = 5.5 V, V <sub>CE</sub> = 0 V V <sub>FB</sub> = 0V			1	μA
V <sub>H</sub>	CE / MODE Pins Input Voltage, High	V <sub>IN</sub> = 5.5 V	1.0			V
V <sub>L</sub>	CE / MODE Pins Input Voltage, Low	V <sub>IN</sub> = 2.3 V			0.4	V
I <sub>H</sub>	CE / MODE Pins Input Current, High	V <sub>IN</sub> = V <sub>CE</sub> = 5.5 V	-1	0	1	μA
I <sub>L</sub>	CE / MODE Pins Input Current, Low	V <sub>IN</sub> = 5.5 V, V <sub>CE</sub> = 0 V	-1	0	1	μA
V <sub>UVLO1</sub>	UVLO Detection Voltage	V <sub>IN</sub> = Falling	1.83	2.00		V
V <sub>UVLO2</sub>	UVLO Release Voltage	V <sub>IN</sub> = Rising		2.05	2.25	V
T <sub>TSD</sub>	Thermal Shutdown Threshold Temperature	T <sub>j</sub> , Rising		150		°C
T <sub>TSR</sub>		T <sub>j</sub> , Falling		110		°C
t <sub>START</sub>	Soft-start Time	V <sub>IN</sub> = 3.6 V		1		ms
t <sub>PROT</sub>	Protection Delay Time (RP602ZxxxA/B/C/D)	V <sub>IN</sub> = 3.6 V		1.6		ms
t <sub>RST</sub>	Reset Protection Delay Time (RP602ZxxxC/D)	V <sub>IN</sub> = 3.6 V		12		ms

All test items listed under *ELECTRICAL CHARACTERISTICS* are done under the pulse load condition (T<sub>j</sub> ≈ Ta = 25°C).

<sup>(1)</sup> BULX Current Limit vary according to the switching duty ratio.

## RP602x

No. JA-353-190507

Open-loop Measurement GND = 0 V, unless otherwise noted.

### RP602K Electrical Characteristics

(Ta = 25°C)

Symbol	Item	Conditions	Min.	Typ.	Max.	Unit
I <sub>DD</sub>	Power Current	V <sub>IN</sub> = 5.5 V, V <sub>OUT</sub> = 4.2 V, V <sub>MODE</sub> = 5.5 V		27.5	60	μA
		V <sub>MODE</sub> = 0 V		1000	1400	
I <sub>STANDBY</sub>	Standby Current	V <sub>IN</sub> = 5.5 V, V <sub>CE</sub> = 0 V		0.1	5.0	μA
V <sub>OUT</sub>	Output Voltage	V <sub>IN</sub> = 3.6 V	x0.985		x1.015	V
Δ V <sub>OUT</sub> / ΔTa	Output Voltage Temperature Coefficient	-40°C ≤ Ta ≤ 85°C		±50		ppm/°C
V <sub>OVP</sub>	OVP Detection Voltage	V <sub>IN</sub> = 3.6 V, Rising	4.5	5.0	5.5	V
	OVP release Voltage	V <sub>IN</sub> = 3.6 V, Falling	4.3	4.8	5.3	V
f <sub>OSC</sub>	Switching Frequency	V <sub>IN</sub> = 3.6 V	2.4	2.6	2.9	MHz
I <sub>LIMHS</sub>	BULX Current Limit <sup>(1)</sup>	V <sub>IN</sub> = 3.6 V	3.7	4.2		A
R <sub>ON</sub>	High & Low Switch On-resistance	V <sub>IN</sub> = 3.6 V		120		mΩ
R <sub>DIS</sub>	On-resistance of Discharge Tr. (RP602KxxxE/G)	V <sub>IN</sub> = 3.6 V, V <sub>CE</sub> = 0 V		80		Ω
I <sub>FBH</sub>	V <sub>FB</sub> Input Current, High	V <sub>IN</sub> = 5.5 V, V <sub>CE</sub> = 0 V V <sub>FB</sub> = 5.5V			1	μA
I <sub>FBL</sub>	V <sub>FB</sub> Input Current, Low	V <sub>IN</sub> = 5.5 V, V <sub>CE</sub> = 0 V V <sub>FB</sub> = 0V			1	μA
V <sub>H</sub>	CE / MODE Pins Input Voltage, High	V <sub>IN</sub> = 5.5 V	1.0			V
V <sub>L</sub>	CE / MODE Pins Input Voltage, Low	V <sub>IN</sub> = 2.3 V			0.4	V
I <sub>H</sub>	CE / MODE Pins Input Current, High	V <sub>IN</sub> = V <sub>CE</sub> = 5.5 V	-1	0	1	μA
I <sub>L</sub>	CE / MODE Pins Input Current, Low	V <sub>IN</sub> = 5.5 V, V <sub>CE</sub> = 0 V	-1	0	1	μA
V <sub>UVLO1</sub>	UVLO Detection Voltage	V <sub>IN</sub> = Falling	1.83	2.00		V
V <sub>UVLO2</sub>	UVLO Release Voltage	V <sub>IN</sub> = Rising		2.05	2.25	V
T <sub>TSD</sub>	Thermal Shutdown Threshold Temperature	T <sub>j</sub> , Rising		150		°C
T <sub>TSR</sub>		T <sub>j</sub> , Falling		110		°C
t <sub>START</sub>	Soft-start Time	V <sub>IN</sub> = 3.6 V		1		ms
t <sub>PROT</sub>	Protection Delay Time (RP602KxxxE/F/G/H)	V <sub>IN</sub> = 3.6 V		1.6		ms
t <sub>RST</sub>	Reset Protection Delay Time (RP602KxxxG/H)	V <sub>IN</sub> = 3.6 V		12		ms

All test items listed under *ELECTRICAL CHARACTERISTICS* are done under the pulse load condition (T<sub>j</sub> ≈ Ta = 25°C).

<sup>(1)</sup> BULX Current Limit vary according to the switching duty ratio.



**Product-specific Electrical Characteristics**

(Ta = 25°C)

Product Name	V <sub>OUT</sub> (V)		
	Min.	Typ.	Max.
RP602x270x	2.660	2.700	2.740
RP602x280x	2.758	2.800	2.842
RP602x290x	2.857	2.900	2.943
RP602x300x	2.955	3.000	3.045
RP602x310x	3.054	3.100	3.146
RP602x320x	3.152	3.200	3.248
RP602x330x	3.251	3.300	3.349
RP602x340x	3.349	3.400	3.451
RP602x350x	3.448	3.500	3.552
RP602x360x	3.546	3.600	3.654
RP602x370x	3.645	3.700	3.755
RP602x380x	3.743	3.800	3.857
RP602x390x	3.842	3.900	3.958
RP602x400x	3.940	4.000	4.060
RP602x410x	4.039	4.100	4.161
RP602x420x	4.137	4.200	4.263

## THEORY OF OPERATION

### Soft-start Time

#### Starting-up with CE Pin

The IC starts to operate when the CE pin voltage ( $V_{CE}$ ) exceeds the threshold voltage. The threshold voltage is preset between CE “High” input voltage ( $V_{CEH}$ ) and CE “Low” input voltage ( $V_{CEL}$ ). After the start-up of the IC, soft-start circuit starts to operate. Then, after a certain period of time, the reference voltage ( $V_{REF}$ ) in the IC gradually increases up to the specified value. Soft-start time ( $t_{START}$ ) starts when soft-start circuit is activated, and ends when the reference voltage reaches the specified voltage. Soft start time is not always equal to the turn-on speed of the DC/DC converter. Note that the turn-on speed could be affected by the power supply capacity, the output current, the inductance value and the  $C_{OUT}$  value.

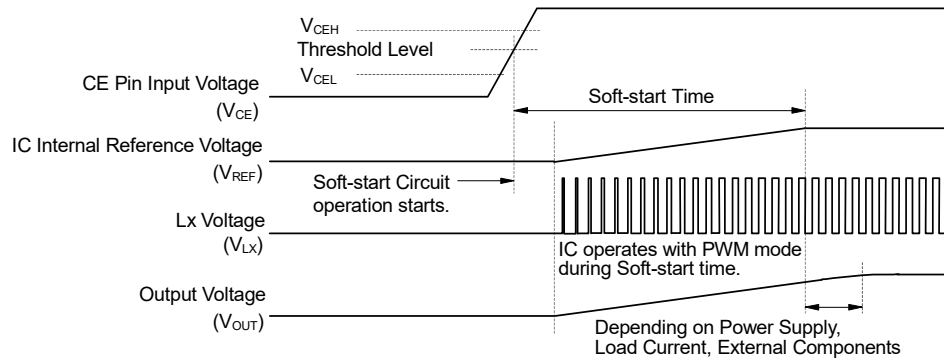

Timing Chart: Starting-up with CE Pin

#### Starting-up with Power Supply

After the power-on, when  $V_{IN}$  exceeds the UVLO release voltage ( $V_{UVLO2}$ ), the IC starts to operate. Then, soft-start circuit starts to operate and after a certain period of time,  $V_{REF}$  gradually increases up to the specified value. Soft-start time starts when soft-start circuit is activated, and ends when  $V_{REF}$  reaches the specified voltage. Note that the turn-on speed of  $V_{OUT}$  could be affected by the power supply capacity, the output current, the inductance value, the  $C_{OUT}$  value and the turn-on speed of  $V_{IN}$  determined by  $C_{IN}$ .

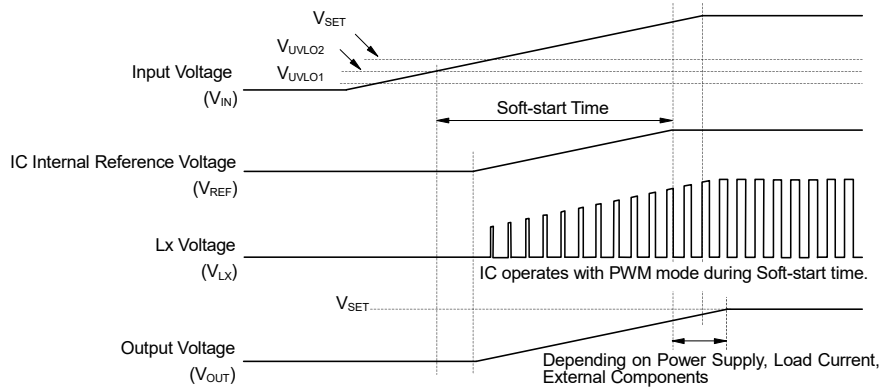

Timing Chart: Starting-up with Power Supply

### Undervoltage Lockout (UVLO) Circuit

If the  $V_{IN}$  becomes lower than the UVLO detection voltage ( $V_{UVLO1}$ ), the UVLO circuit starts to operate,  $V_{REF}$  stops, and P-channel and N-channel built-in switch transistors turn “OFF”. As a result,  $V_{OUT}$  drops according to the  $C_{OUT}$  capacitance value and the load. To restart the operation,  $V_{IN}$  needs to be higher than  $V_{UVLO2}$ .

### Overvoltage Protection (OVP) Circuit

If the  $V_{OUT}$  becomes higher than the OVP detection voltage ( $V_{OVP}$ ), the OVP circuit starts to operate, P-channel and N-channel built-in switch transistors turn “OFF”. As a result,  $V_{OUT}$  drops according to the  $C_{OUT}$  capacitance value and the load.

### Overcurrent Protection Circuit

Overcurrent protection circuit supervises the inductor peak current (the peak current flowing through Pch Tr (SW1) in each switching cycle, and if the current exceeds the BULX current limit ( $I_{LXLIM}$ ), it turns off Pch Tr (SW1).  $I_{LXLIM}$  of the RP602x is set to Typ.4200 mA.

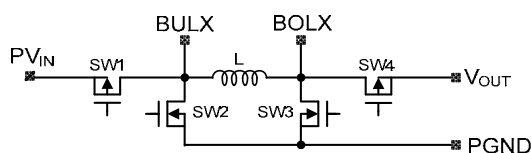

Simplified Diagram of Output Switches

### Short Protection Circuit

If the  $V_{OUT}$  becomes lower than a certain threshold, the BULX current limit is reduced.

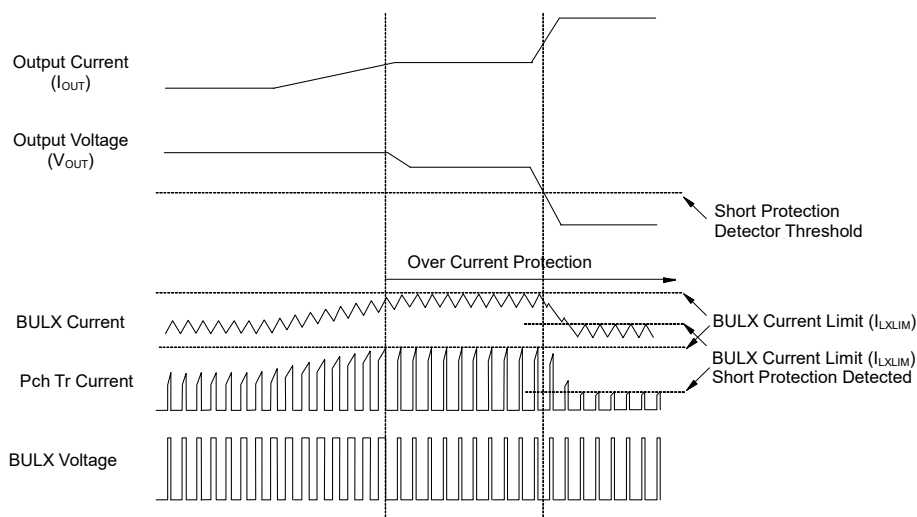

Timing Chart: Overcurrent Protection Circuit & Short Protection Circuit

---

## RP602x

---

No. JA-353-190507

### Latch Type Protection Circuit: RP602xxxxA/B/E/F

The latch type protection circuit latches the built-in drivers of SW1, SW2, SW3 and SW4 off to stop the operation of the device if the overcurrent state continues more than the protection delay time ( $t_{\text{PROT}}$ ).

To release the latch-type protection, reset the device by switching the CE pin from High to Low or making the input voltage ( $V_{\text{IN}}$ ) lower than the UVLO detection voltage ( $V_{\text{UVLO1}}$ ).

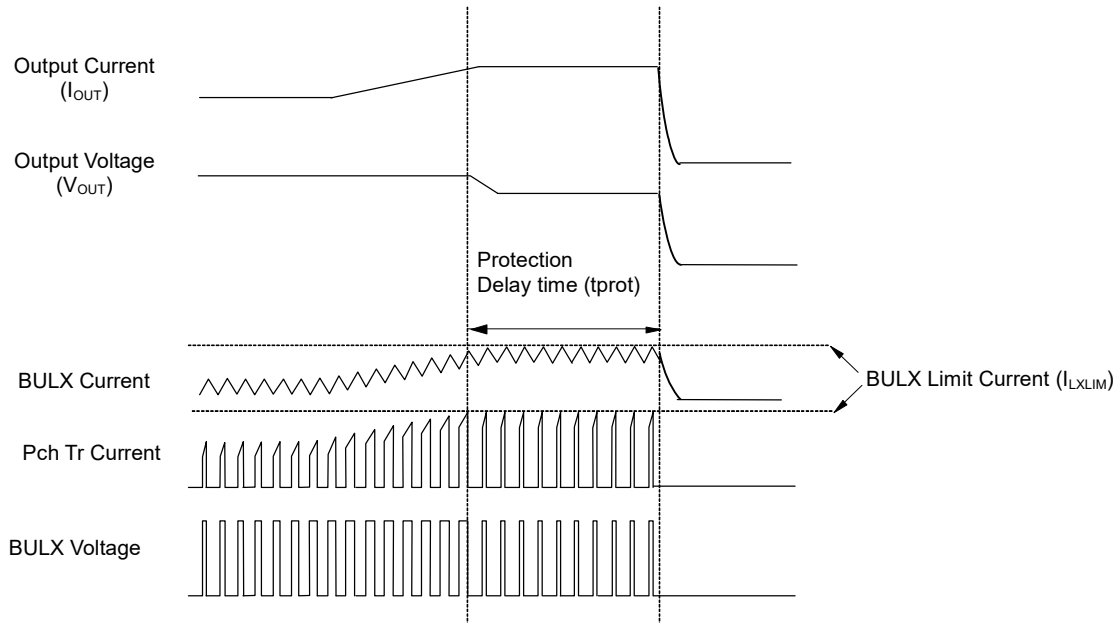

**Timing Chart: RP602xxxxA/B/E/F Latch Protection Circuit**

**Reset Type Protection Circuit: RP602xxxxC/D/G/H**

When the overcurrent state continues more than the protection delay time ( $t_{PROT}$ ), the reset type protection circuit operates and switching stops. The built-in drivers of SW1, SW2, SW3 and SW4 turn off and restarts after the reset protection delay time ( $t_{RST}$ ). When the overcurrent state is released, the operation is automatically released and returns to normal operation.

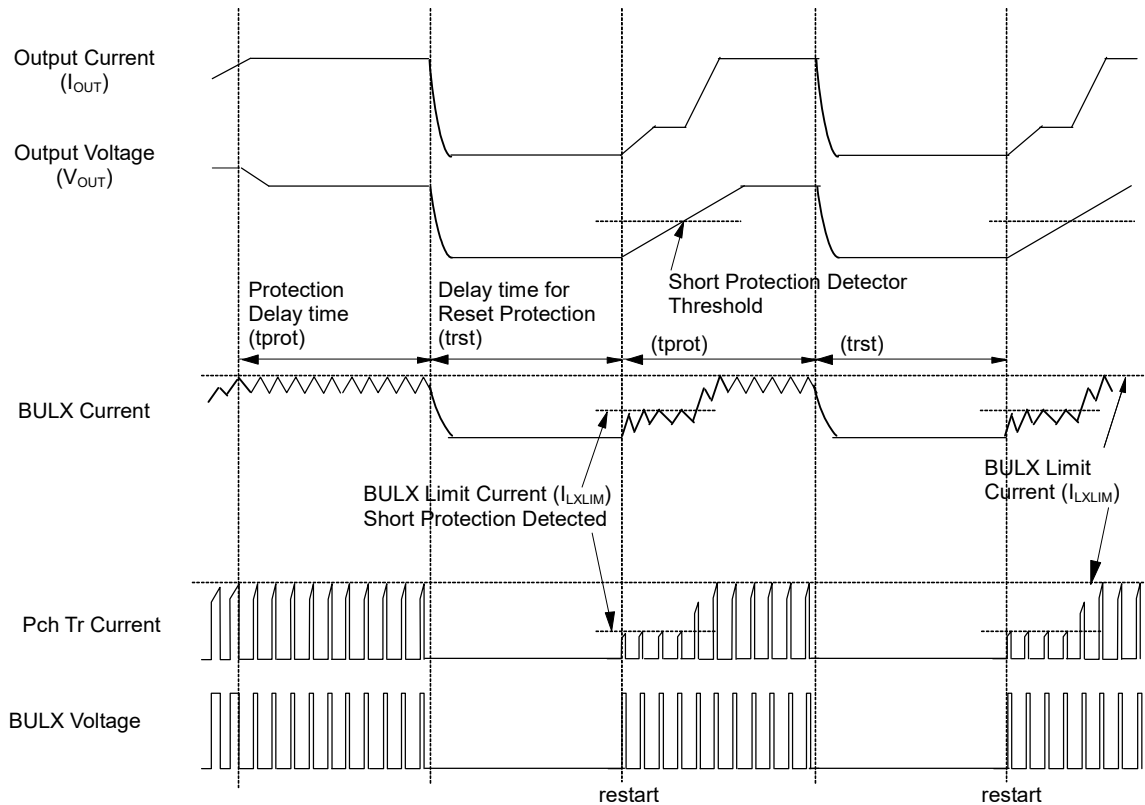

**Timing Chart: RP602xxxxC/D/G/H Reset Protection Circuit**

---

## RP602x

---

No. JA-353-190507

### APPLICATION INFORMATION

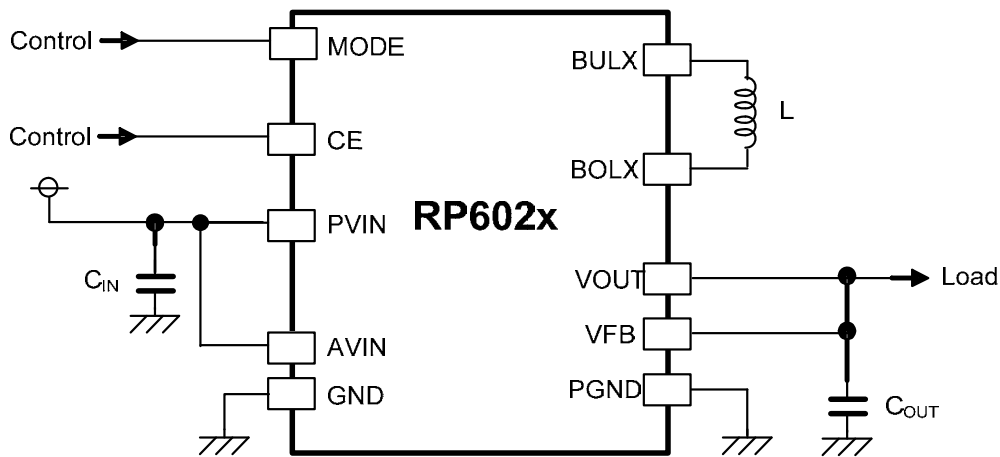

RP602x Typical Application Circuit

#### Recommended External Components

Symbol	Description
C <sub>IN</sub> <sup>(1)</sup>	10 $\mu$ F, Ceramic, GRM188R60J106ME47, Murata
C <sub>OUT</sub> <sup>(2)</sup>	22 $\mu$ F x 2, Ceramic, GRM188R60J226MEA0, Murata
L	1.0 $\mu$ H, Inductor, DFE201610P- 1R0M, TOKO 1.0 $\mu$ H, Inductor, XAL4020- 102ME, Coilcraft

#### Technical Notes on External Components Selection

- Use ceramic capacitors having a low equivalent series resistance (ESR). C<sub>OUT</sub> should be paralleled with another C<sub>OUT</sub>. When selecting the capacitors, consider the bias characteristics and input/ output voltage.
- When the built-in switches are turned off, the inductor may generate a spike-shaped high voltage. Use the high-breakdown voltage capacitor (C<sub>OUT</sub>) which output voltage is 1.5 times or more than the set output voltage.
- Use an inductor that has a low DC resistance, has an enough tolerable current and is less likely to cause magnetic saturation. If the inductance value is extremely small, the peak current of LX may increase. When the peak current of LX reaches to the LX limit current (I<sub>LXLIM</sub>), overcurrent protection circuit starts to operate. When selecting the inductor, consider the peak current of LX pin (I<sub>LXMAX</sub>). Refer to *Calculation Method of Peak Current of LX Pin (I<sub>LXMAX</sub>) in Continuous Mode* for details.

---

<sup>(1)</sup> Place C<sub>IN</sub> as close as possible to the PV<sub>IN</sub> pin.

<sup>(2)</sup> Place C<sub>OUT</sub> as close as possible to the V<sub>OUT</sub> pin.

---

### Calculation Method of Peak Current of LX Pin ( $I_{LXMAX}$ ) in Continuous Mode

The peak current of LX pin ( $I_{LXMAX}$ ) can be calculated as follows, in the case of an ideal buck converter operating in steady conditions, using the components listed in *Recommended External Components of APPLICATION INFORMATION*.

Ripple Current P-P value is described as  $I_{RP}$ , ON resistance of Pch. Tr. is described as  $R_{ONP}$ , ON resistance of Nch. Tr. is described as  $R_{ONN}$ , and DC resistor of the inductor is described as  $R_L$ .

First, when Pch. Tr. is "ON", the following equation is satisfied.

$$V_{IN} = V_{OUT} + (R_{ONP} + R_L) \times I_{OUT} + L \times I_{RP} / t_{ON} \dots \dots \dots \text{Equation 1}$$

Second, when Pch. Tr. is "OFF" (Nch. Tr. is "ON"), the following equation is satisfied.

$$L \times I_{RP} / t_{OFF} = R_{ONN} \times I_{OUT} + V_{OUT} + R_L \times I_{OUT} \dots \dots \dots \text{Equation 2}$$

Put Equation 2 into Equation 1 to solve ON duty of Pch. Tr. ( $D_{ON} = t_{ON} / (t_{OFF} + t_{ON})$ ):

$$D_{ON} = (V_{OUT} + R_{ONN} \times I_{OUT} + R_L \times I_{OUT}) / (V_{IN} + R_{ONN} \times I_{OUT} - R_{ONP} \times I_{OUT}) \dots \dots \dots \text{Equation 3}$$

Ripple Current is described as follows:

$$I_{RP} = (V_{IN} - V_{OUT} - R_{ONP} \times I_{OUT} - R_L \times I_{OUT}) \times D_{ON} / f_{osc} / L \dots \dots \dots \text{Equation 4}$$

Peak current that flows through L, and LX Tr. is described as follows:

$$I_{LXmax} = I_{OUT} + I_{RP} / 2 \dots \dots \dots \text{Equation 5}$$

---

**RP602x**

---

No. JA-353-190507

The peak current of LX pin ( $I_{LXMAX}$ ) can be calculated as follows, in the case of an ideal boost converter operating in steady conditions, using the components listed in *Recommended External Components* of *APPLICATION INFORMATION*.

Ripple Current P-P value is described as  $I_{RP}$ , Average inductor current is described as  $I_{LX}$ , ON resistance of Pch. Tr. and ON resistance of Nch. Tr. is described as  $R_{ONP}$  and  $R_{ONN}$  respectively, and DC resistor of the inductor is described as  $R_L$ .

First, when Nch. Tr. is "ON", the following equation is satisfied.

$$L \times I_{RP} / t_{ON} = V_{IN} - (R_L + R_{ONN}) \times I_{LX} \dots \dots \dots \text{Equation 6}$$

Second, when Nch. Tr. is "OFF" (Pch. Tr. is "ON"), the following equation is satisfied.

$$L \times I_{RP} / t_{OFF} = V_{OUT} + (R_L + R_{ONP}) \times I_{LX} - V_{IN} \dots \dots \dots \text{Equation 7}$$

Put Equation 7 into Equation 6 to solve ON duty of Nch. Tr. ( $D_{ON} = t_{ON} / (t_{OFF} + t_{ON})$ ):

$$D_{ON} = (V_{OUT} - V_{IN} + R_L \times I_{LX} + R_{ONP} \times I_{LX}) / (V_{OUT} + R_{ONP} \times I_{LX} - R_{ONN} \times I_{LX}) \dots \dots \dots \text{Equation 8}$$

Ripple Current is described as follows:

$$I_{RP} = (V_{IN} - R_L \times I_{LX} - R_{ONN} \times I_{LX}) \times D_{ON} / f_{OSC} / L \dots \dots \dots \text{Equation 9}$$

Peak current that flows through L ( $I_{LMAX}$ ), and LX Tr. is described as follows:

$$I_{LMAX} = I_{LX} + I_{RP} / 2 \dots \dots \dots \text{Equation 10}$$

Also, the average peak current ( $I_{OUT}$  and  $D_{ON}$ ) in the boost circuit is described as follows:

$$I_{LX} = I_{OUT} / (1 - D_{ON}) \dots \dots \dots \text{Equation 11}$$



## TECHNICAL NOTES

The performance of a power source circuit using this device is highly dependent on a peripheral circuit. A peripheral component or the device mounted on PCB should not exceed a rated voltage, a rated current or a rated power. When designing a peripheral circuit, please be fully aware of the following points.

- Place the bypass capacitor ( $C_{IIN}$ ) between the PVIN pin and the GND pin with shortest-distance wiring.
- Place the output capacitor ( $C_{OUT}$ ) between the  $V_{OUT}$  pin and the GND pin with shortest-distance wiring. Connect GND of  $C_{OUT}$  to the GND pin with shortest-distance wiring.
- Make the GND plane wide.
- Ensure the PVIN and GND lines are firmly connected. A large switching current flows through the PVIN, GND, inductor, BOLX, BULX and  $V_{OUT}$  lines. If their impedance is too high, noise pickup or unstable operation may result.
- Connect the BOLX pin and the inductor and the BULX pin with shortest-distance wiring.

**PCB LAYOUT CONSIDERATIONS****Current Paths on PCB**

Figure 1 and Figure 2 show the current pathways of step-up circuit when NMOSFET is turned on. Figure 3 and Figure 4 show the current pathways of step-down circuit when PMOSFET is turned on.

The currents flow in the directions of blue or green arrows. The parasitic components, such as impedance, inductance or capacitance, formed in the pathways indicated by the red arrows affect the stability of the system and become the cause of noise. Reduce the parasitic components as much as possible. The current pathways should be made by short and thick wirings.

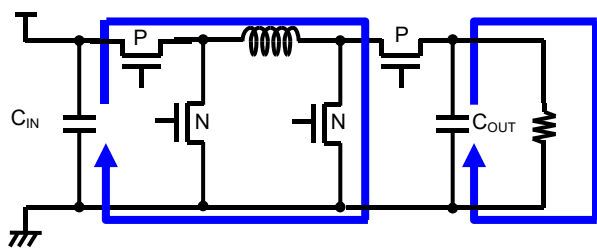

Figure 1. NMOSFET-ON (Step-up)

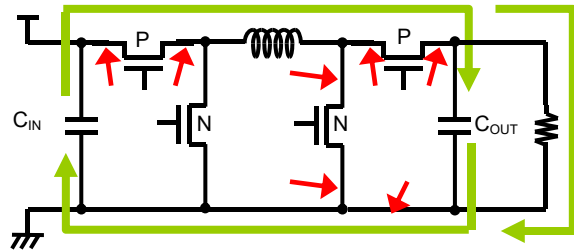

Figure 2. PMOSFET-ON (Step-up)

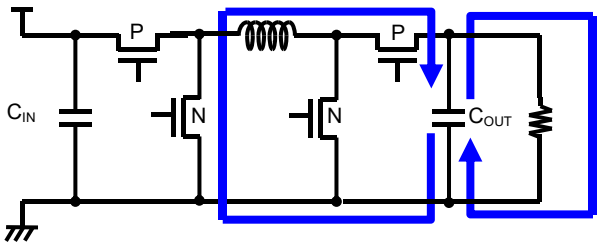

Figure 3. NMOSFET-ON (Step-down)

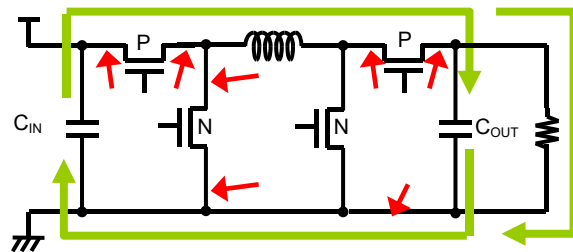
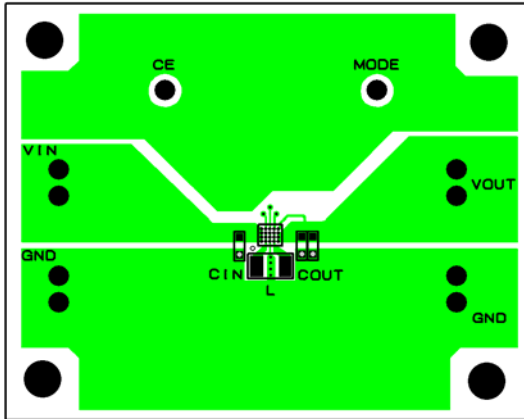

Figure 4. PMOSFET-ON (Step-down)

PCB LAYOUT

Top Layer



Bottom Layer

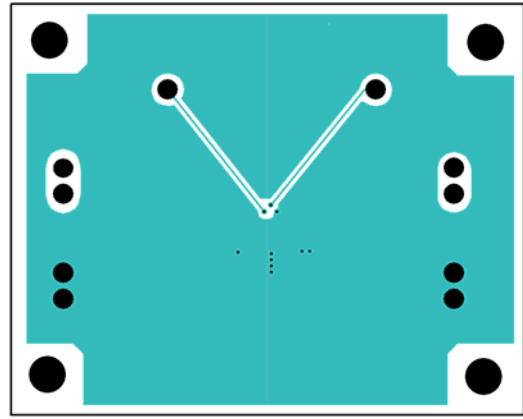

RP602x [PKG: WLCSP-20-P1] PCB Layout

Top Layer

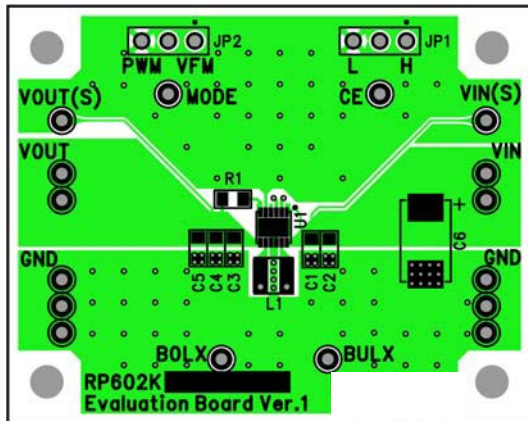

Bottom Layer

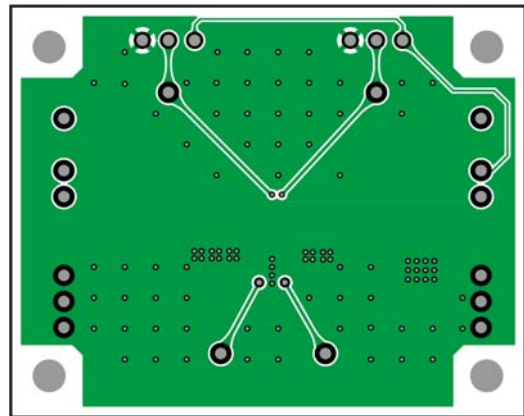

RP602x [PKG: DFN(PLP)2730-12] PCB Layer

---

# RP602x

---

No. JA-353-190507

## TYPICAL CHARACTERISTICS

Note: Typical Characteristics are intended to be used as reference data; they are not guaranteed.

### 1) Input Voltage vs. Output Voltage RP602Z330x, MODE = H

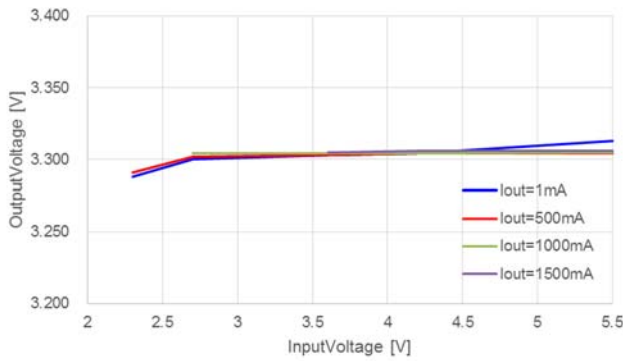

### RP602Z330x, MODE = L

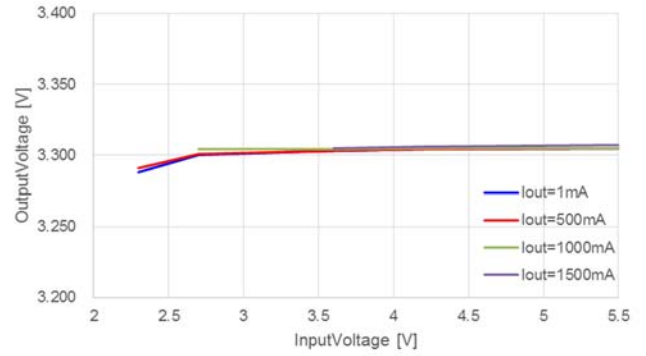

### 2) Output Current vs. Efficiency (for Different Input Voltages) RP602Z330x, MODE = H

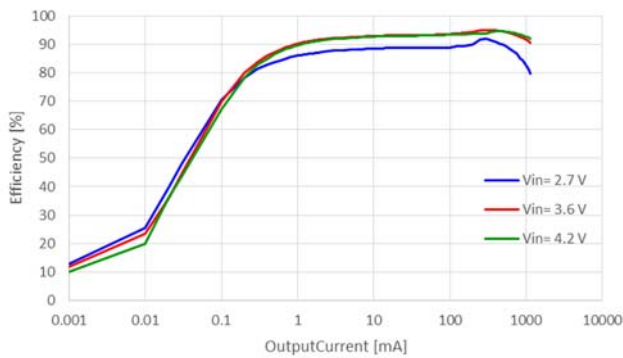

### RP602Z330x, MODE = L

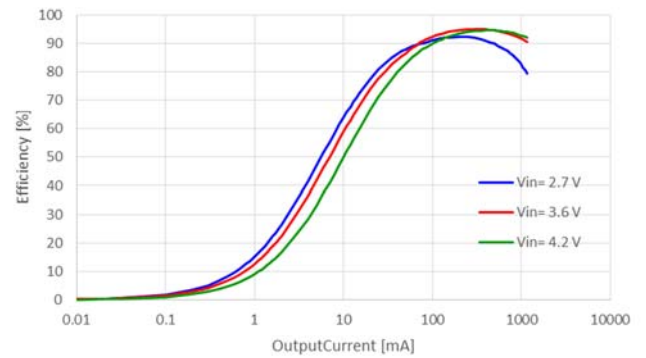

### 3) Output Current vs. Output Voltage RP602Z330x, MODE = H

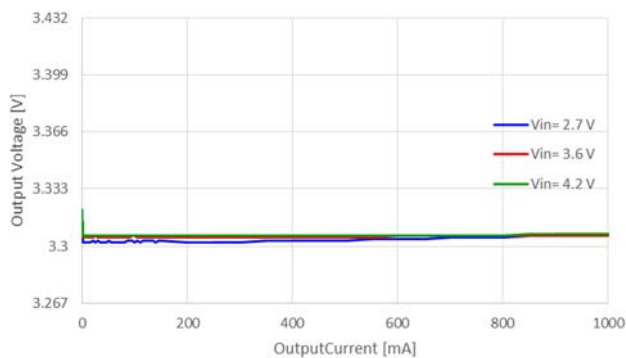

### RP602Z330x, MODE = L

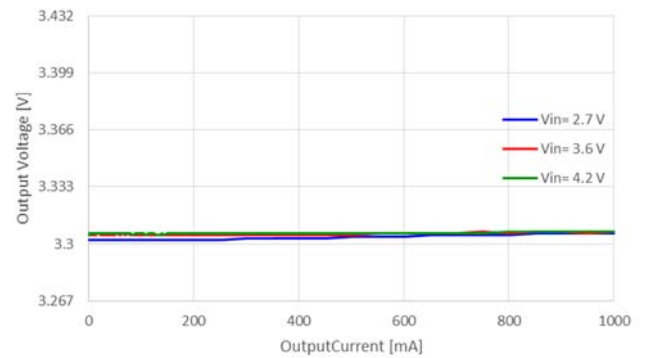

**4) Temperature vs. Output Voltage  
RP602Z330x**

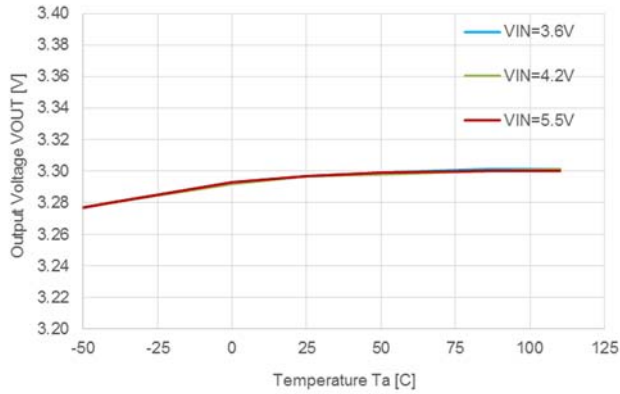

**5) Temperature vs. Standby Current  
RP602Z330x, VIN = 5.5 V**

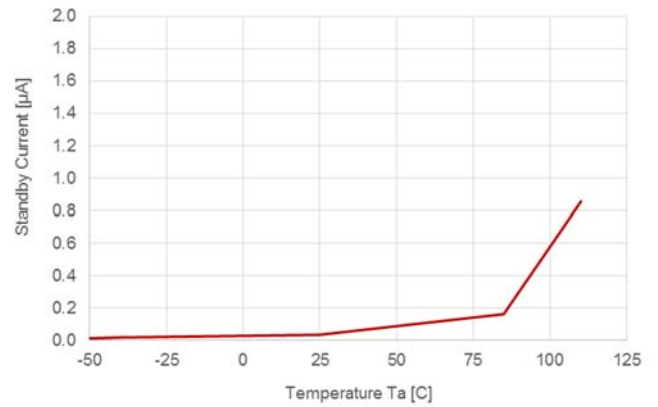

**6) Input Voltage vs. Output Current  
RP602Z330x, MODE = L**

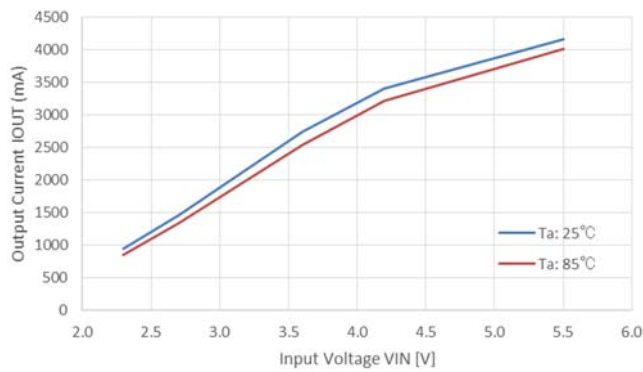

**7) Temperature vs. Soft-start Time  
RP602Z330x**

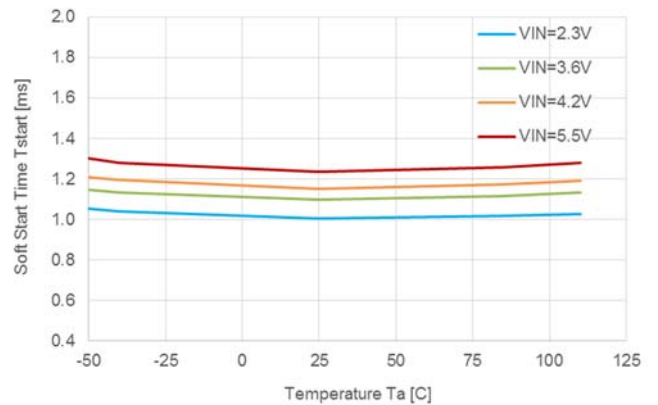

**8) CE Start-up Waveform  
RP602Z330x, VIN = 3.6 V, MODE = H  
IOUT = 0 mA**

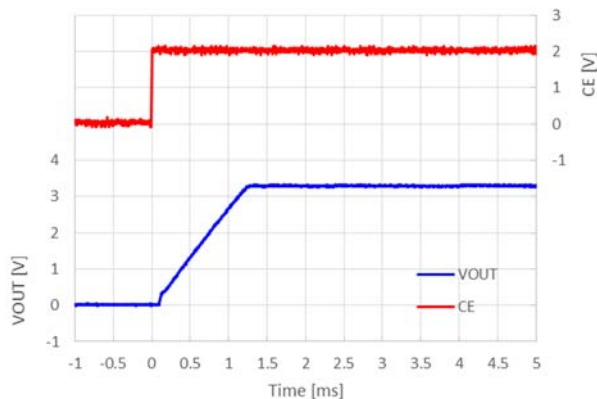

**RP602Z330x, VIN = 5.5 V, MODE = H  
IOUT = 0 mA**

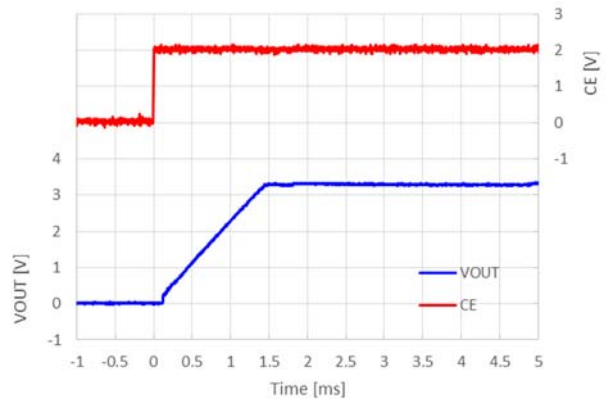

---

## RP602x

---

No. JA-353-190507

**RP602Z330x,  $V_{IN} = 3.6\text{ V}$ , MODE = L**  
 **$I_{OUT} = 0\text{ mA}$**

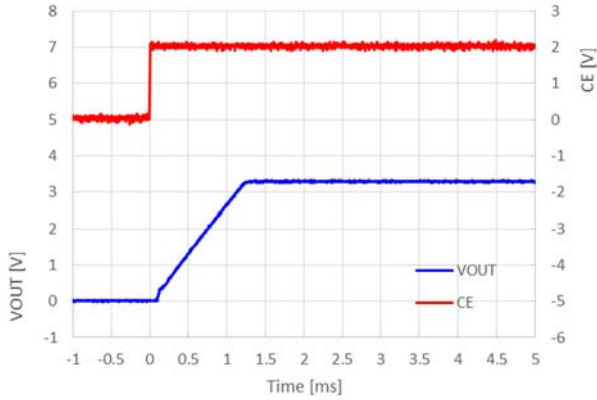

**RP602Z330x,  $V_{IN} = 5.5\text{ V}$ , MODE = L**  
 **$I_{OUT} = 0\text{ mA}$**

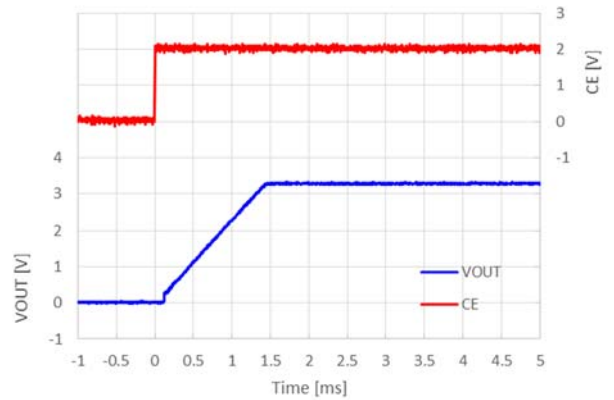

### 9) $V_{OUT}$ Waveform

**RP602Z270x,  $V_{IN} = 3.6\text{ V}$ , MODE = H**  
 **$I_{OUT} = 10\text{ mA}$**

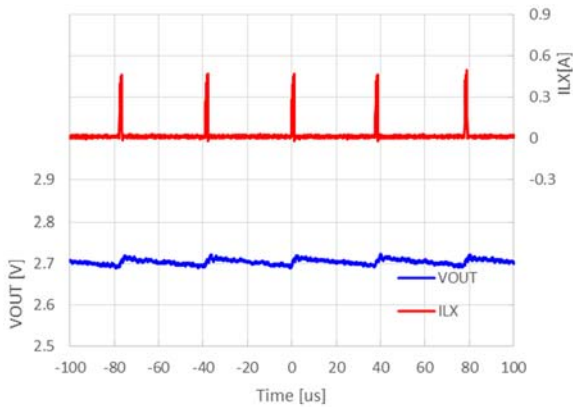

**RP602Z270x,  $V_{IN} = 3.6\text{ V}$ , MODE = L**  
 **$I_{OUT} = 0\text{ mA}$**

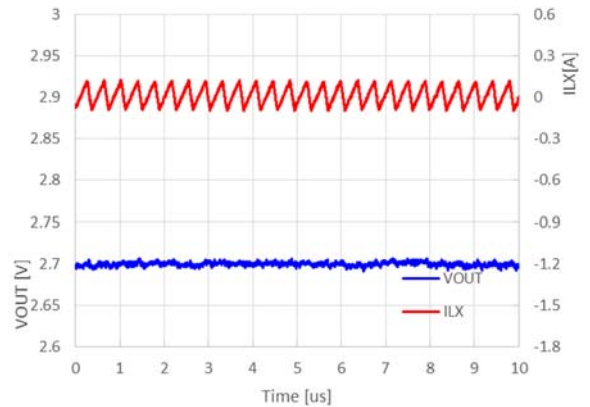

**RP602Z330x,  $V_{IN} = 3.6\text{ V}$ , MODE = H**  
 **$I_{OUT} = 10\text{ mA}$**

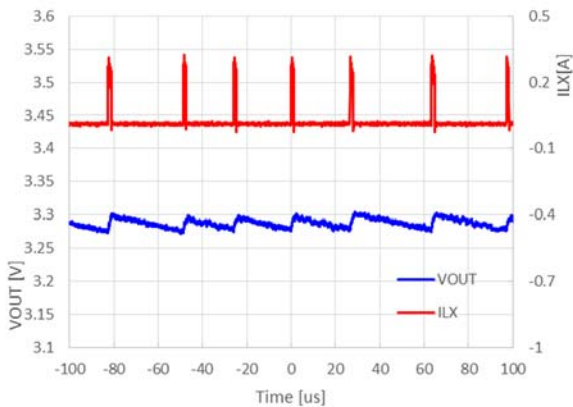

**RP602Z330x,  $V_{IN} = 3.6\text{ V}$ , MODE = L**  
 **$I_{OUT} = 0\text{ mA}$**

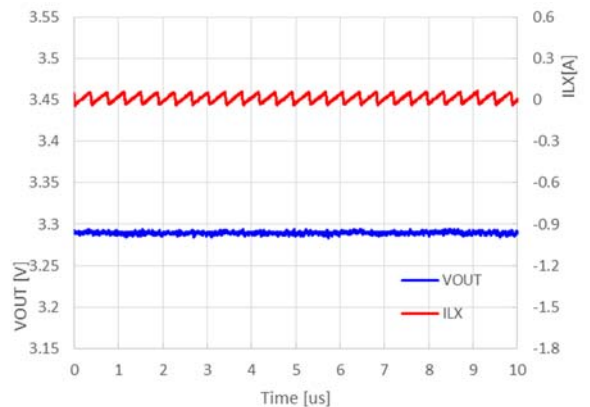

RP602Z420x,  $V_{IN} = 3.6\text{ V}$ , MODE = H  
 $I_{OUT} = 10\text{ mA}$

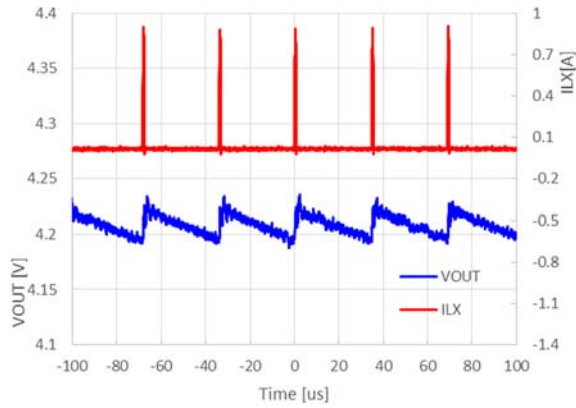

RP602Z420x,  $V_{IN} = 3.6\text{ V}$ , MODE = L  
 $I_{OUT} = 0\text{ mA}$

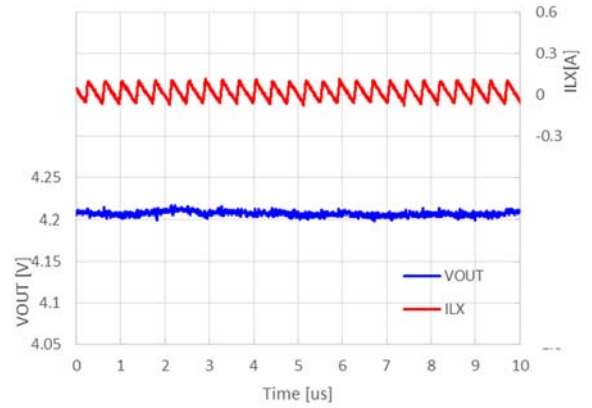

10) Load Transient Response Waveform  
 RP602Z330x,  $V_{IN} = 3.6\text{ V}$ , MODE = H  
 $I_{OUT} = 1\text{ mA} \leftrightarrow 500\text{ mA}$

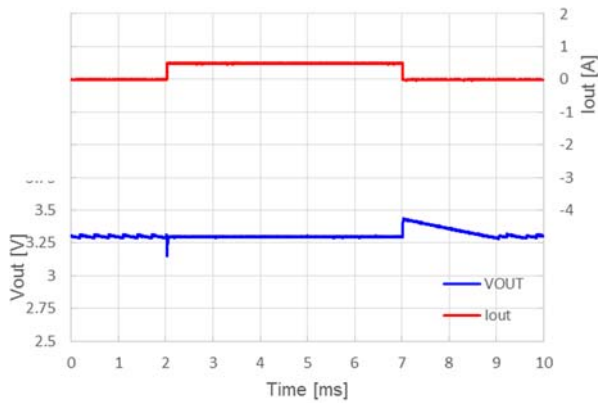

RP602Z330x,  $V_{IN} = 3.6\text{ V}$ , MODE = L  
 $I_{OUT} = 1\text{ mA} \leftrightarrow 500\text{ mA}$

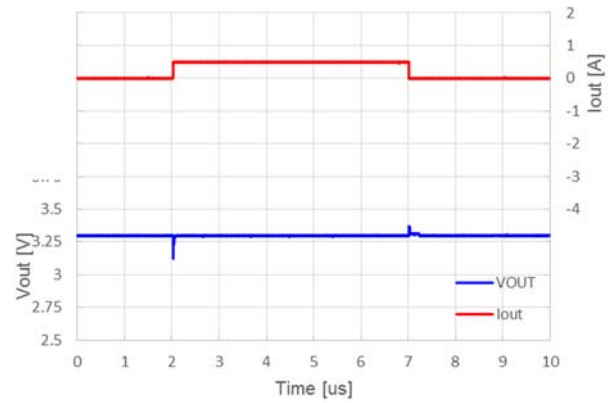

RP602Z330x,  $V_{IN} = 3.6\text{ V}$ , MODE = H  
 $I_{OUT} = 50\text{ mA} \leftrightarrow 900\text{ mA}$

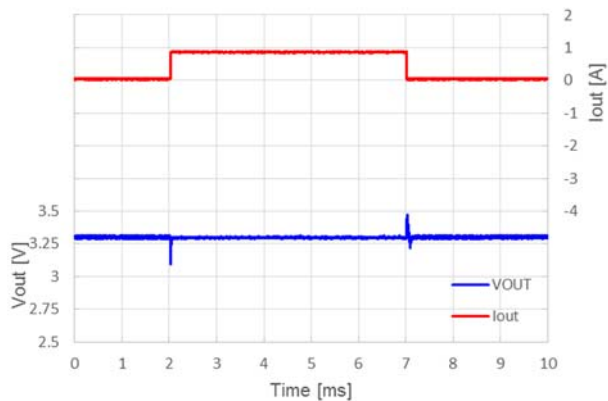

RP602Z330x,  $V_{IN} = 3.6\text{ V}$ , MODE = L  
 $I_{OUT} = 50\text{ mA} \leftrightarrow 900\text{ mA}$

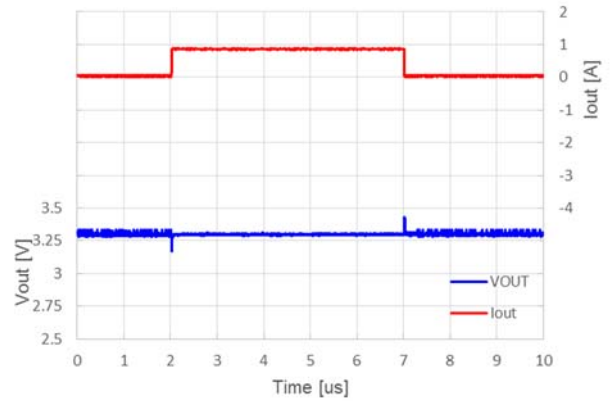



---

## RP602x

---

No. JA-353-190507

**RP602Z330x,  $V_{IN} = 3.6\text{ V}$ , MODE = H**  
 **$I_{OUT} = 1000\text{ mA} \leftrightarrow 1500\text{ mA}$**

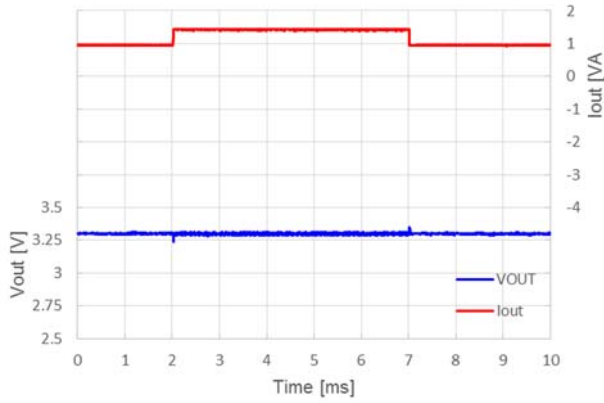

**RP602Z330x,  $V_{IN} = 3.6\text{ V}$ , MODE = L**  
 **$I_{OUT} = 1000\text{ mA} \leftrightarrow 1500\text{ mA}$**

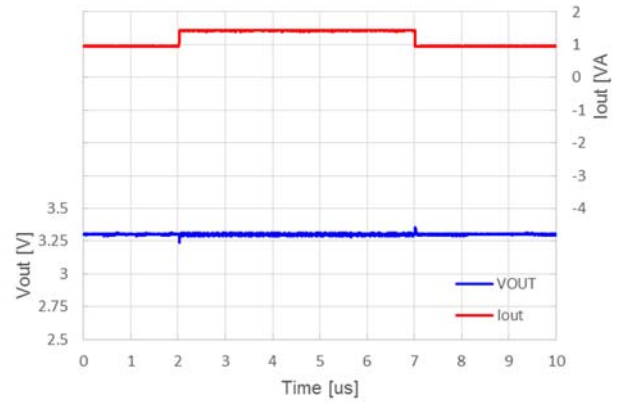

**11) CE Turn off Waveform**  
**RP602Z330x,  $V_{IN} = 3.6\text{ V}$ , MODE = H**  
 **$I_{OUT} = 0\text{ mA}$**

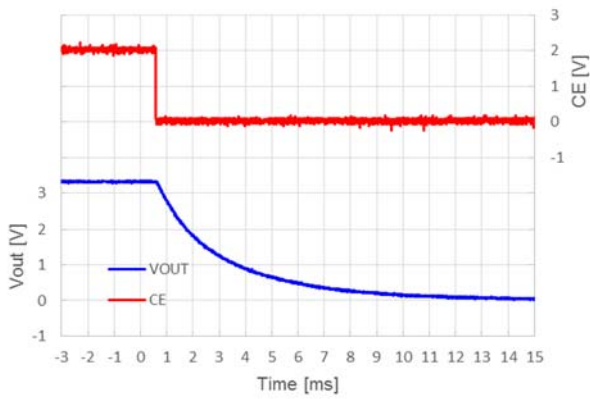

**RP602Z330x,  $V_{IN} = 3.6\text{ V}$ , MODE = L**  
 **$I_{OUT} = 0\text{ mA}$**

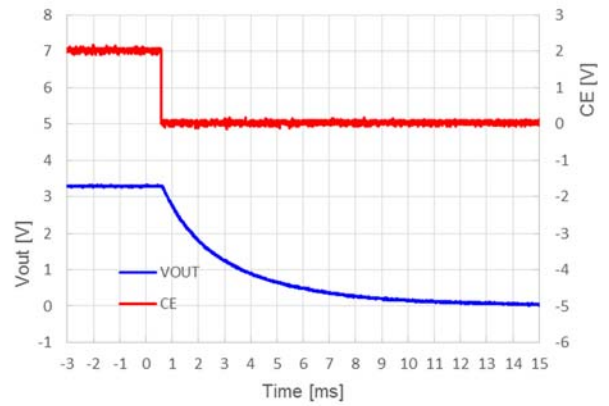

**12) Input Transient Response Waveform**  
**RP602Z330x, MODE = H**  
 **$I_{OUT} = 500\text{ mA}$ ,  $V_{IN} = 2.5\text{ V} \leftrightarrow 4.5\text{ V}$**

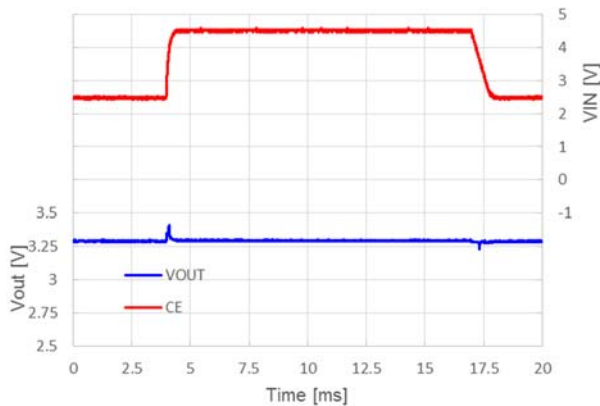

**RP602Z330x, MODE = L**  
 **$I_{OUT} = 500\text{ mA}$ ,  $V_{IN} = 2.5\text{ V} \leftrightarrow 4.5\text{ V}$**

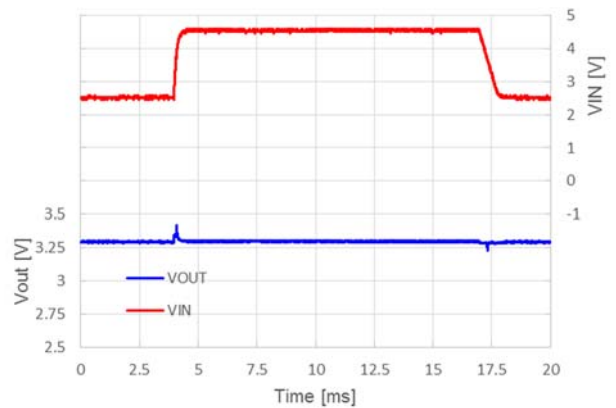



The power dissipation of the package is dependent on PCB material, layout, and environmental conditions. The following measurement conditions are based on JEDEC STD. 51-9.

**Measurement Conditions**

Item	Measurement Conditions
Environment	Mounting on Board (Wind Velocity = 0 m/s)
Board Material	Glass Cloth Epoxy Plastic (Four-Layer Board)
Board Dimensions	101.5 mm x 114.5 mm x 1.6 mm
Copper Ratio	Outer Layers (First and Fourth Layers): 60% Inner Layers (Second and Third Layers): 100%

**Measurement Result**

(Ta = 25°C, Tjmax = 125°C)

Item	Measurement Result
Power Dissipation	1400 mW
Thermal Resistance ( $\theta_{ja}$ )	$\theta_{ja} = (125 - 25^\circ\text{C}) / 1.4\text{W} = 71^\circ\text{C/W}$

$\theta_{ja}$ : Junction-to-Ambient Thermal Resistance

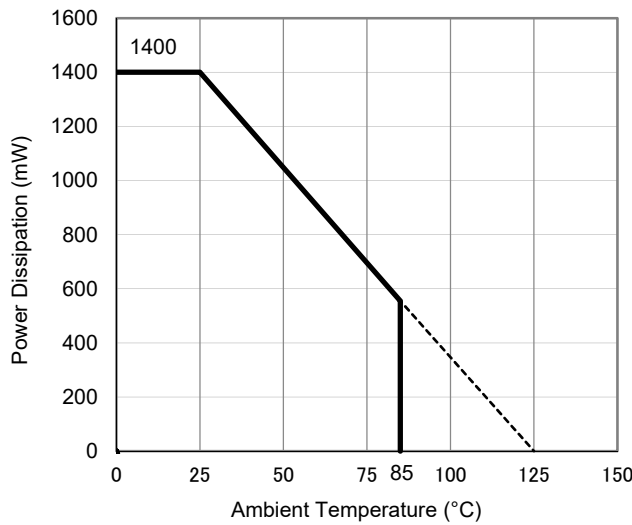

**Power Dissipation vs. Ambient Temperature**

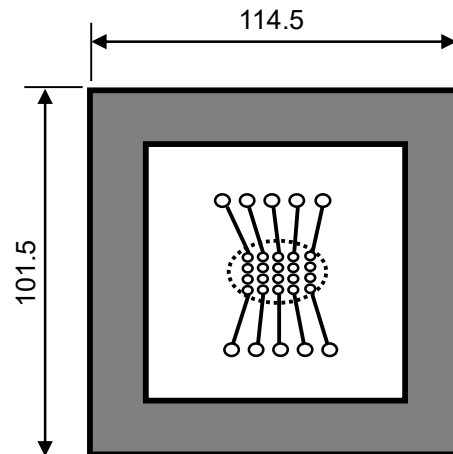

**Measurement Board Pattern**

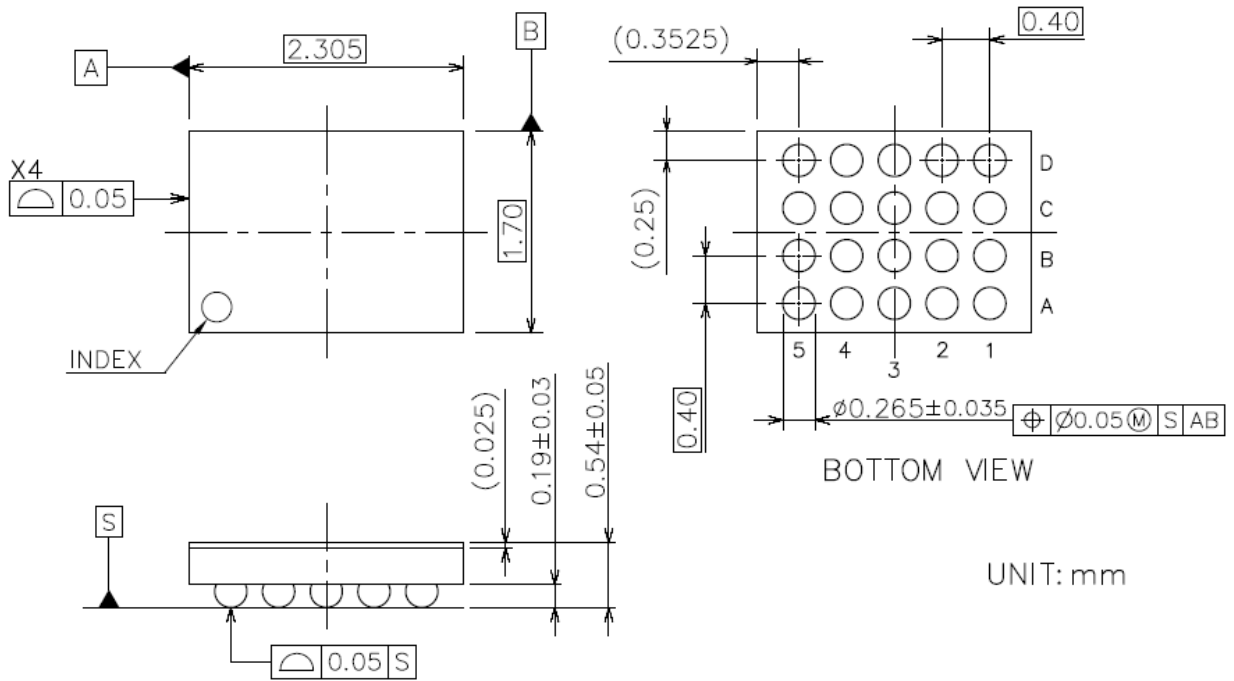

**WLCSP-20-P1 Package Dimensions (Unit: mm)**

The power dissipation of the package is dependent on PCB material, layout, and environmental conditions. The following measurement conditions are based on JEDEC STD. 51-7.

**Measurement Conditions**

Item	Measurement Conditions
Environment	Mounting on Board (Wind Velocity = 0 m/s)
Board Material	Glass Cloth Epoxy Plastic (Four-Layer Board)
Board Dimensions	76.2 mm × 114.3 mm × 0.8 mm
Copper Ratio	Outer Layer (First Layer): Less than 95% of 50 mm Square Inner Layers (Second and Third Layers): Approx. 100% of 50 mm Square Outer Layer (Fourth Layer): Approx. 100% of 50 mm Square
Through-holes	φ 0.3 mm × 23 pcs

**Measurement Result**

(Ta = 25°C, Tjmax = 125°C)

Item	Measurement Result
Power Dissipation	3100 mW
Thermal Resistance (θja)	θja = 32°C/W
Thermal Characterization Parameter (ψjt)	ψjt = 8°C/W

θja: Junction-to-Ambient Thermal Resistance

ψjt: Junction-to-Top Thermal Characterization Parameter

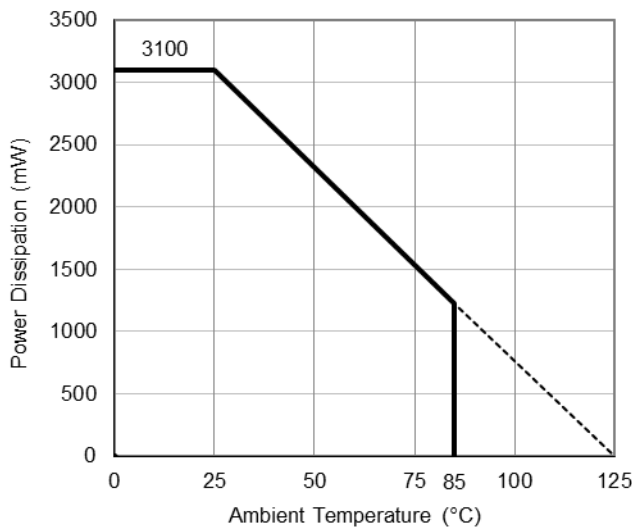

**Power Dissipation vs. Ambient Temperature**

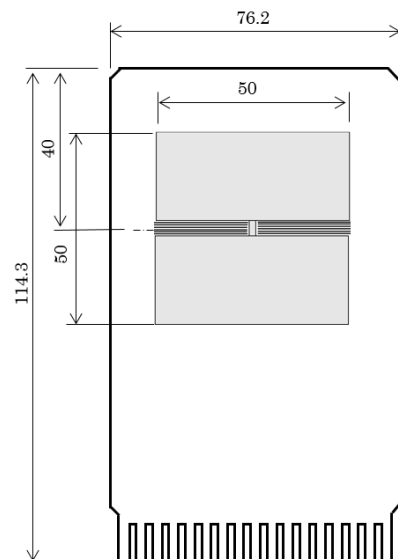

**Measurement Board Pattern**

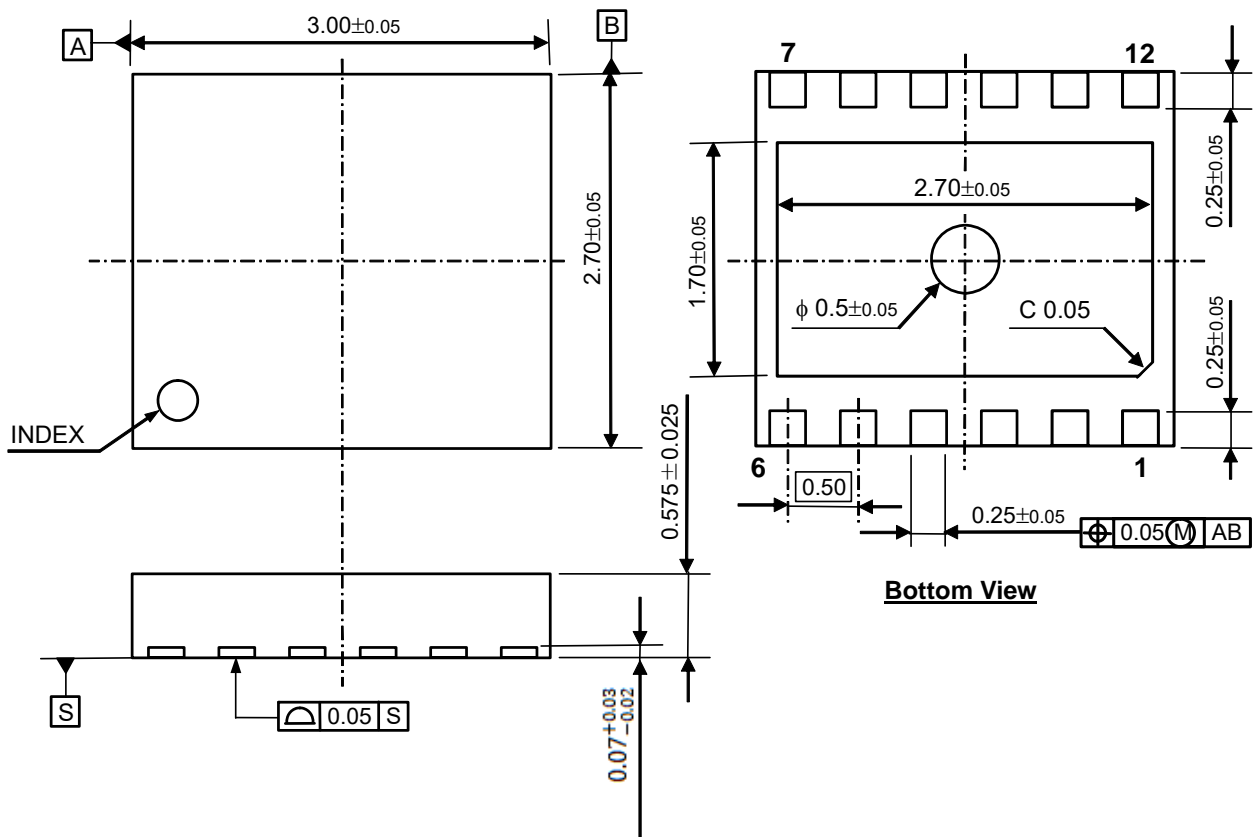

DFN(PLP)2730-12 Package Dimensions (Unit: mm)



1. The products and the product specifications described in this document are subject to change or discontinuation of production without notice for reasons such as improvement. Therefore, before deciding to use the products, please refer to our sales representatives for the latest information thereon.
2. The materials in this document may not be copied or otherwise reproduced in whole or in part without prior written consent of our company.
3. Please be sure to take any necessary formalities under relevant laws or regulations before exporting or otherwise taking out of your country the products or the technical information described herein.
4. The technical information described in this document shows typical characteristics of and example application circuits for the products. The release of such information is not to be construed as a warranty of or a grant of license under our company's or any third party's intellectual property rights or any other rights.
5. The products listed in this document are intended and designed for use as general electronic components in standard applications (office equipment, telecommunication equipment, measuring instruments, consumer electronic products, amusement equipment etc.). Those customers intending to use a product in an application requiring extreme quality and reliability, for example, in a highly specific application where the failure or misoperation of the product could result in human injury or death (aircraft, spacevehicle, nuclear reactor control system, traffic control system, automotive and transportation equipment, combustion equipment, safety devices, life support system etc.) should first contact us.
6. We are making our continuous effort to improve the quality and reliability of our products, but semiconductor products are likely to fail with certain probability. In order to prevent any injury to persons or damages to property resulting from such failure, customers should be careful enough to incorporate safety measures in their design, such as redundancy feature, fire containment feature and fail-safe feature. We do not assume any liability or responsibility for any loss or damage arising from misuse or inappropriate use of the products.
7. Anti-radiation design is not implemented in the products described in this document.
8. The X-ray exposure can influence functions and characteristics of the products. Confirm the product functions and characteristics in the evaluation stage.
9. WLCSP products should be used in light shielded environments. The light exposure can influence functions and characteristics of the products under operation or storage.
10. There can be variation in the marking when different AOI (Automated Optical Inspection) equipment is used. In the case of recognizing the marking characteristic with AOI, please contact our sales or our distributor before attempting to use AOI.
11. Please contact our sales representatives should you have any questions or comments concerning the products or the technical information.



**Nisshinbo Micro Devices Inc.**

**Official website**

<https://www.nisshinbo-microdevices.co.jp/en/>

**Purchase information**

<https://www.nisshinbo-microdevices.co.jp/en/buy/>

