

---

## 2 A PWM/VFM Step-down DC/DC Converter with Synchronous Rectifier

---

No.EA-296-210909

### OUTLINE

The RP506K is a low supply current CMOS-based PWM/VFM step-down DC/DC converter with synchronous rectifier featuring 2 A<sup>(1)</sup> output current. Internally, a single converter consists of an oscillator, a reference voltage unit, an error amplifier, a switching control circuit, a mode control circuit, a soft start circuit, a latch type protection circuit, an under-voltage lockout (UVLO) circuit, a thermal shutdown circuit, and switching transistors. The RP506K is employing synchronous rectification for improving the efficiency of rectification by replacing diodes with built-in switching transistors. Using synchronous rectification not only increases circuit performance but also allows a design to reduce parts count.

Power controlling method can be selected from forced PWM control type or PWM/VFM auto switching control type by inputting a signal to the MODE pin. In low output current, forced PWM control switches at fixed frequency rate in order to reduce noise. Likewise, in low output current, PWM/VFM auto switching control automatically switches from PWM mode to VFM mode in order to achieve high efficiency.

Output voltage type can be selected from an internally fixed output voltage type (RP506Kxx1A/B/D/E) or an externally adjustable output voltage type (RP506K001C/F). The output voltage of the RP506Kxx1A/B/D/E can be set by 0.1 V step and the output voltage accuracy is as high as  $\pm 1.5\%$  or  $\pm 18$  mV. The output voltage of the RP506K001C/F can be set by using the external resistors.

Oscillator frequency can be selected from 2.25 MHz (RP506Kxx1A/B/C) or 1.2 MHz (RP506Kxx1D/E/F). Soft-start time is Typ. 0.15 ms, and by connecting an external capacitor to the TSS pin, soft-start time is adjustable. Power good (PG) function monitors the  $V_{OUT}$  pin voltage or the feedback pin voltage ( $V_{FB}$ ), and switches the PG pin to low if any abnormal condition is detected.

Protection circuits included in the RP506K are over current protection circuit, latch type protection circuit and thermal shutdown circuit. Over current protection circuit supervises the inductor peak current in each switching cycle, and if the current exceeds the  $I_{LX(LIM)}$ , it turns off Pch Tr. Latch type protection circuit latches the built-in driver to the OFF state and stops the operation of the step-down DC/DC converter if the over current status continues or  $V_{OUT}$  continues being the half of the setting voltage for equal or longer than protection delay time ( $t_{prot}$ ). Thermal shutdown circuit detects overheating of the converter if the output pin is shorted to the ground pin (GND) etc. and stops the converter operation to protect it from damage if the junction temperature exceeds the specified temperature.

The RP506K is available in DFN(PLP)2527-10 which achieves high-density mounting on boards.

---

<sup>(1)</sup> This is an approximate value. The output current is dependent on conditions and external components.

---

## RP506K

---

No.EA-296-210909

### FEATURES

- Supply Current.....Typ. 48  $\mu$ A (VFM mode, Lx at no load)
- Standby Current.....Typ. 0  $\mu$ A
- Input Voltage Range .....2.5 V to 5.5 V (Absolute Maximum Ratings: 6.5 V)
- Output Voltage Range<sup>(1)</sup>..... Fixed output voltage type (RP506Kxx1A/B/D/E) : to 3.3 V by 0.1 V step  
Adjustable output voltage type (RP506K001C/F) : to 4.0 V

Version	Forced PWM Control	PWM/VFM Auto Switching Control
RP506Kxx1A/B	1.1 V to 3.3 V	0.8 V to 3.3 V
RP506K001C	1.1 V to 4.0 V	0.8 V to 4.0 V
RP506Kxx1D/E	0.6 V to 3.3 V	
RP506K001F	0.6 V to 4.0 V	

- Output Voltage Accuracy..... $\pm 1.5\%$  ( $V_{SET}^{(2)} \geq 1.2$  V),  
..... $\pm 18$  mV ( $V_{SET} < 1.2$  V) (RP506Kxx1A/B/D/E)
- Feedback Voltage Accuracy..... $\pm 9$  mV ( $V_{FB} = 0.6$  V) (RP506K001C/F)
- Output Voltage/Feedback Voltage  
Temperature Coefficient ..... $\pm 100$  ppm/ $^{\circ}$ C
- Oscillator Frequency .....Typ. 2.25 MHz (RP506Kxx1A/B/C)  
.....Typ. 1.2 MHz (RP506Kxx1D/E/F)
- Oscillator Maximum Duty .....Min. 100%
- Built-in Driver ON Resistance.....Typ. Pch. 0.130  $\Omega$ , Nch. 0.125  $\Omega$  ( $V_{IN} = 3.6$  V)
- UVLO Detector Threshold .....Typ. 2.2 V
- Inductor Current Limit Circuit.....Current limit Typ. 2.8 A
- Latch Type Protection Circuit .....Typ. 1.5 ms
- Package.....DFN(PLP)2527-10

### APPLICATION

- Power source for Li-ion battery-used equipment
- Power source for portable communication equipment, camcorder, DSC, Notebook PC
- Power source for HDD, WLAN

---

<sup>(1)</sup> Refer to *Selection Guide* for detailed information.

<sup>(2)</sup>  $V_{SET}$  = Set Output Voltage

---

## SELECTION GUIDE

The set output voltage, the output voltage type, the auto-discharge function<sup>(1)</sup>, and the oscillator frequency for the ICs are user-selectable options.

### Selection Guide

Product Name	Package	Quantity per Reel	Pb Free	Halogen Free
RP506Kxx1\$(y)-TR	DFN(PLP)2527-10	5,000 pcs	Yes	Yes

xx: Designation of the set output voltage ( $V_{SET}$ )<sup>(2)</sup>

For Fixed Output Voltage Type<sup>(3)</sup>: 0.6 V to 3.3 V in 0.1 V steps

For Adjustable Output Voltage Type: 00 only

(y): If  $V_{SET}$  includes the 3rd digit, indicate the digit of 0.01 V.

(1.25 V)

Ex. If  $V_{SET}$  is 1.25 V, RP506K121\$5-TR.

\$: Designation of Version

Version	Output Voltage Type	Auto-discharge Function	Oscillator Frequency	$V_{SET}$	
				Forced PWM	PWM/VFM Auto Switching
RP506Kxx1A	Fixed	No	2.25 MHz	1.1 V to 3.3 V	0.8 V to 3.3 V
RP506Kxx1B		Yes			
RP506K001C	Adjustable	No	1.2 MHz	1.1 V to 4.0 V	0.8 V to 4.0 V
RP506Kxx1D	Fixed				
RP506Kxx1E		Yes	0.6 V to 3.3 V		
RP506K001F	Adjustable	No		0.6 V to 4.0 V	

<sup>(1)</sup> Auto-discharge function quickly lowers the output voltage to 0 V, when the chip enable signal is switched from the active mode to the standby mode, by releasing the electrical charge accumulated in the external capacitor.

<sup>(2)</sup>  $V_{SET}$  can be set only within the specified range of voltage. Refer to *Designation of Version* for detailed information.

<sup>(3)</sup> 0.05 V step is also available as a custom code.

---

# RP506K

---

No.EA-296-210909

## BLOCK DIAGRAM

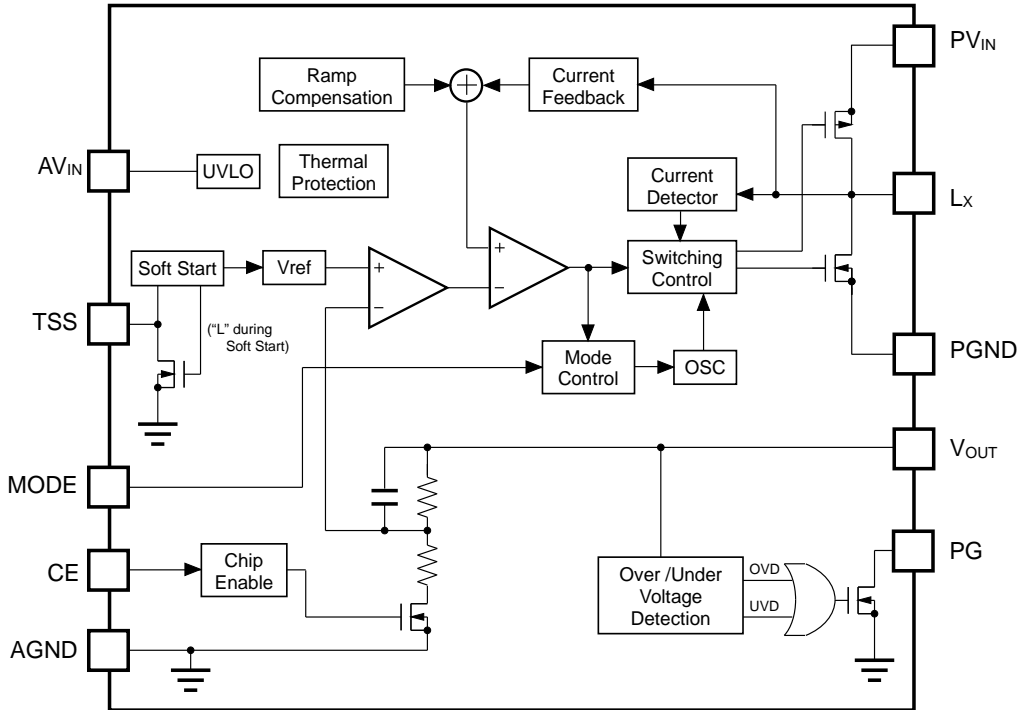

RP506Kxx1A/D Block Diagram

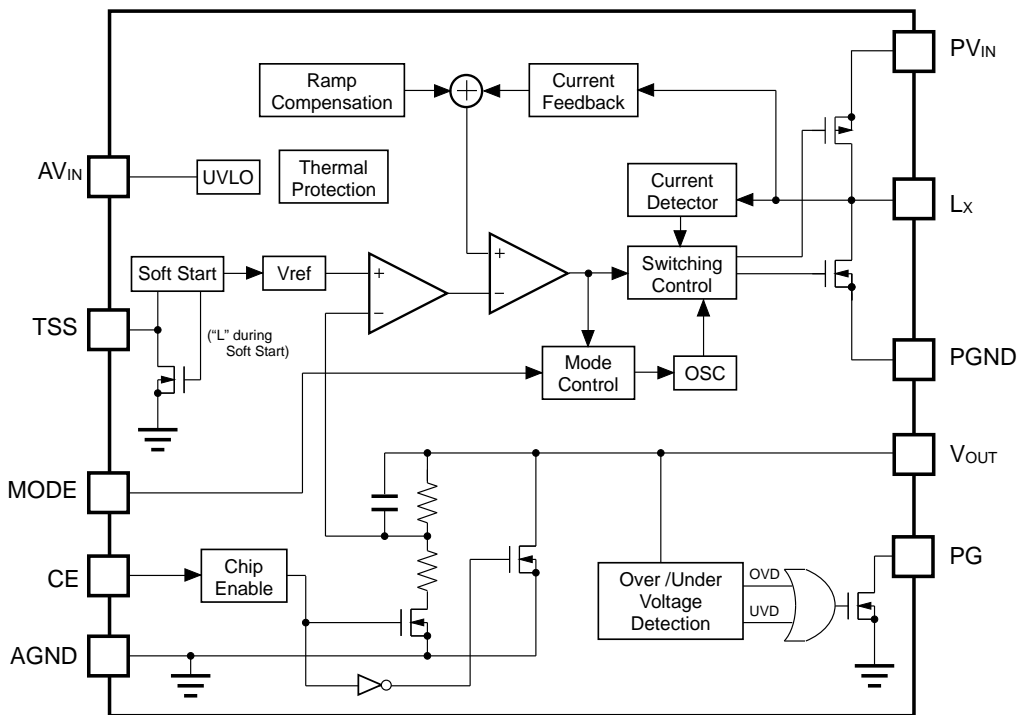

RP506Kxx1B/E Block Diagram

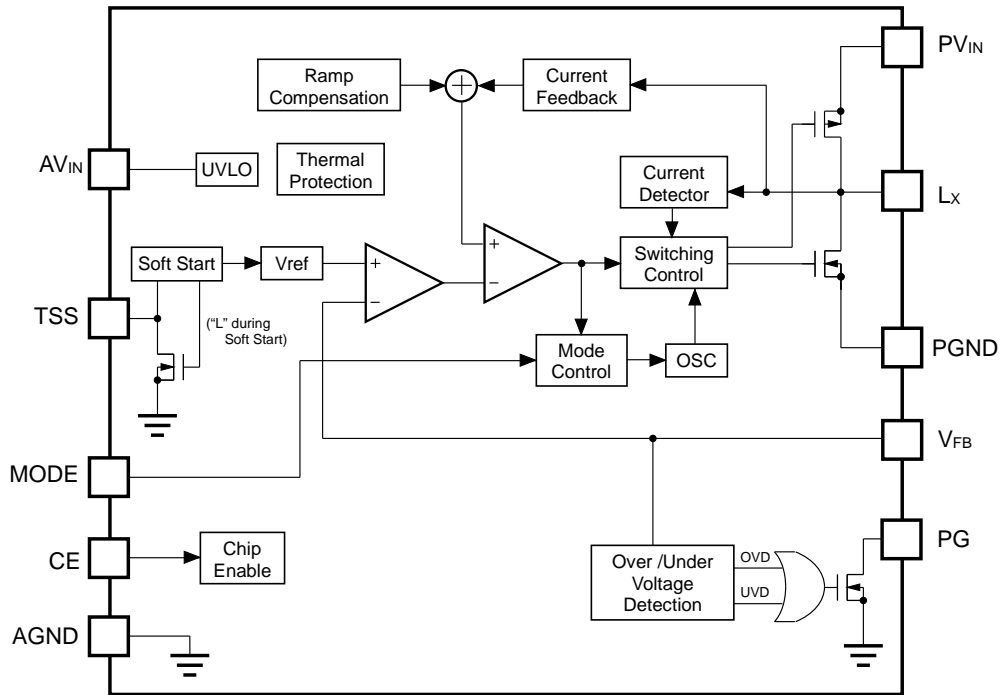

RP506K001C/F Block Diagram

---

## RP506K

---

No.EA-296-210909

### PIN DESCRIPTION

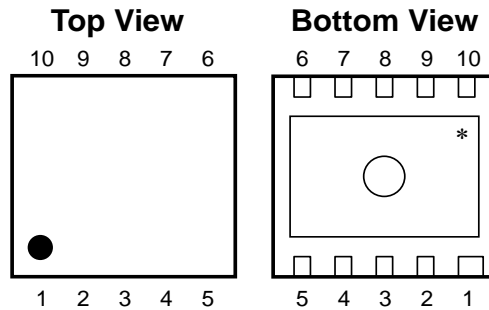

**DFN(PLP)2527-10 Pin Configurations**

#### DFN(PLP)2527-10 Pin Description

Pin No.	Symbol	Description
1	PV <sub>IN</sub>	PV <sub>IN</sub> Input Voltage Pin <sup>(1)</sup>
2	AV <sub>IN</sub>	AV <sub>IN</sub> Input Voltage Pin <sup>(1)</sup>
3	PG	Power Good Pin
4	CE	Chip Enable Pin (Active "H")
5	MODE	Mode Control Pin ("H": forced PWM control, "L": PWM/VFM auto switching control)
6	TSS	Soft-start Pin
7	V <sub>OUT</sub> / V <sub>FB</sub>	Output/ Feedback Voltage Pin
8	AGND	Analog Ground Pin <sup>(2)</sup>
9	L <sub>x</sub>	Switching Pin
10	PGND	Power Ground Pin <sup>(2)</sup>

\* The tab on the bottom of the package enhances thermal performance and is electrically connected to GND (substrate level). It is recommended that the tab be connected to the ground plane on the board, or otherwise be left floating.

---

<sup>(1)</sup> No.1 pin and No.2 pin must be wired to the V<sub>IN</sub> plane when mounting on boards.

<sup>(2)</sup> No.8 pin and No.10 pin must be wired to the GND plane when mounting on boards.

---

## ABSOLUTE MAXIMUM RATINGS

### Absolute Maximum Ratings

(AGND = PGND = 0 V)

Symbol	Item	Rating	Unit	
V <sub>IN</sub>	A/PV <sub>IN</sub> Pin Voltage	-0.3 to 6.5	V	
V <sub>LX</sub>	L <sub>X</sub> Pin Voltage	-0.3 to A/PV <sub>IN</sub> +0.3	V	
V <sub>CE</sub>	CE Pin Voltage	-0.3 to 6.5	V	
V <sub>OUT/V<sub>FB</sub></sub>	V <sub>OUT/V<sub>FB</sub></sub> Pin Voltage	-0.3 to 6.5	V	
V <sub>MODE</sub>	MODE Pin Voltage	-0.3 to 6.5	V	
V <sub>PG</sub>	PG Pin Voltage	-0.3 to 6.5	V	
V <sub>TSS</sub>	TSS Pin Voltage	-0.3 to AV <sub>IN</sub> +0.3	V	
I <sub>LX</sub>	L <sub>X</sub> Pin Output Current	2.8	A	
P <sub>D</sub>	Power Dissipation <sup>(1)</sup>	Standard Land Pattern	910	mW
		High Wattage Land Pattern	1400	mW
T <sub>j</sub>	Junction Temperature	-40 to 125	°C	
T <sub>stg</sub>	Storage Temperature Range	-55 to 125	°C	

### ABSOLUTE MAXIMUM RATINGS

Electronic and mechanical stress momentarily exceeded absolute maximum ratings may cause permanent damage and may degrade the life time and safety for both device and system using the device in the field. The functional operation at or over these absolute maximum ratings are not assured.

## RECOMMENDED OPERATING CONDITIONS

### Recommended Operating Conditions

Symbol	Item	Rating	Unit
V <sub>IN</sub>	Input Voltage	2.5 to 5.5	V
T <sub>a</sub>	Operating Temperature Range	-40 to 85	°C

### RECOMMENDED OPERATING CONDITIONS

All of electronic equipment should be designed that the mounted semiconductor devices operate within the recommended operating conditions. The semiconductor devices cannot operate normally over the recommended operating conditions, even if they are used over such ratings by momentary electronic noise or surge. And the semiconductor devices may receive serious damage when they continue to operate over the recommended operating conditions.

<sup>(1)</sup> Refer to *PACKAGE INFORMATION* for detailed information.

---

**RP506K**

---

No.EA-296-210909

**ELECTRICAL CHARACTERISTICS****RP506Kxx1 Electrical Characteristics**

(Ta = 25°C)

Symbol	Item	Conditions	Min.	Typ.	Max.	Unit
Istandby	Standby Current	A/PVIN = 5.5 V, VCE = 0 V		0	5	μA
ICEH	CE "H" Input Current	A/PVIN = VCE = 5.5 V	-1	0	1	μA
ICEL	CE "L" Input Current	A/PVIN = 5.5 V, VCE = 0 V	-1	0	1	μA
IMODEH	MODE "H" Input Current	A/PVIN = VMODE = 5.5 V, VCE = 0 V	-1	0	1	μA
IMODEL	MODE "L" Input Current	A/PVIN = 5.5 V, VCE = VMODE = 0 V	-1	0	1	μA
ILXLEAKH	Lx Leakage Current "H"	A/PVIN = VLX = 5.5 V, VCE = 0 V	-1	0	6	μA
ILXLEAKL	Lx Leakage Current "L"	A/PVIN = 5.5 V, VCE = VLX = 0 V	-6	0	1	μA
VCEH	CE "H" Input Voltage	A/PVIN = 5.5 V	1.0			V
VCEL	CE "L" Input Voltage	A/PVIN = 2.5 V			0.4	V
VMODEH	MODE "H" Input Voltage	A/PVIN = 5.5 V	1.0			V
VMODEL	MODE "L" Input Voltage	A/PVIN = 2.5 V			0.4	V
RONP	On Resistance of Pch Transistor	A/PVIN = 3.6 V, ILX = -100 mA		0.130		Ω
RONN	On Resistance of Nch Transistor	A/PVIN = 3.6 V, ILX = -100 mA		0.125		Ω
Maxduty	Maximum Duty Cycle		100			%
tstart1	Soft-start Time 1	A/PVIN = VCE = 3.6 V or VSET +1 V, TSS = OPEN		150	300	μs
tstart2	Soft-start Time 2	A/PVIN = VCE = 3.6 V or VSET +1 V, CSS = 0.1 μF	15	30	45	ms
ILXLIM	Lx Current Limit	A/PVIN = VCE = 3.6 V or VSET +1 V	2300	2800		mA
tprot	Protection Delay Time	A/PVIN = VCE = 3.6 V or VSET +1 V	0.5	1.5	5	ms
VUVLO1	UVLO Detector Threshold	A/PVIN = VCE	2.1	2.2	2.3	V
VUVLO2	UVLO Released Voltage	A/PVIN = VCE	2.2	2.3	2.4	V
TTSD	Thermal Shutdown Temperature	Junction Temperature		150		°C
TTSR	Thermal Shutdown Released Temperature	Junction Temperature		100		°C
RPG	On Resistance of PG Pin When Low Output	A/PVIN = 3.6 V, VOUT = 0 V or VFB = 0 V		45		Ω



## ELECTRICAL CHARACTERISTICS (continued)

### RP506Kxx1A/B, RP506K001C (Oscillator Frequency: 2.25 MHz) Electrical Characteristics (Ta = 25°C)

Symbol	Item	Conditions	Min.	Typ.	Max.	Unit
V <sub>IN</sub>	When MODE = H Operating Input Voltage <sup>(1)</sup>	1.1 V ≤ V <sub>SET</sub> < 1.2 V	2.5		4.5	V
		1.2 V ≤ V <sub>SET</sub>	2.5		5.5	
	When MODE = L Operating Input Voltage <sup>(2)</sup>	0.8 V ≤ V <sub>SET</sub> < 1.0 V	2.5		4.5	
		1.0 V ≤ V <sub>SET</sub>	2.5		5.5	
fosc	Oscillator Frequency	A/PV <sub>IN</sub> = V <sub>CE</sub> = 3.6 V or V <sub>SET</sub> + 1 V	2.00	2.25	2.50	MHz

### RP506Kxx1D/E, RP506K001F (Oscillator Frequency: 1.2 MHz) Electrical Characteristics

Symbol	Item	Conditions	Min.	Typ.	Max.	Unit
V <sub>IN</sub>	When MODE = H Operating Input Voltage	0.6 V ≤ V <sub>SET</sub> < 0.7 V	2.5		4.5	V
		0.7 V ≤ V <sub>SET</sub>	2.5		5.5	
	When MODE = L Operating Input Voltage	0.6 V ≤ V <sub>SET</sub>	2.5		5.5	
fosc	Oscillator Frequency	A/PV <sub>IN</sub> = V <sub>CE</sub> = 3.6 V or V <sub>SET</sub> + 1 V	1.00	1.20	1.40	MHz

<sup>(1)</sup> As for RP506Kxx1A/B/C (MODE = H), V<sub>SET</sub> can be set from 1.1 V.

<sup>(2)</sup> As for RP506Kxx1A/B/C (MODE = L), V<sub>SET</sub> can be set from 0.8 V.

**RP506K**

No.EA-296-210909

**ELECTRICAL CHARACTERISTICS (continued)****RP506Kxx1A/B/D/E (Fixed Output Voltage Type) Electrical Characteristics**

(Ta = 25°C)

Symbol	Item	Conditions	Min.	Typ.	Max.	Unit	
V <sub>OUT</sub>	Output Voltage	A/PV <sub>IN</sub> = V <sub>CE</sub> = 3.6 V or V <sub>SET</sub> + 1 V	V <sub>SET</sub> ≥ 1.2 V	x0.985	x1.015	V	
			V <sub>SET</sub> < 1.2 V	-0.018	+0.018		
ΔV <sub>OUT</sub> /ΔTa	Output Voltage Temperature Coefficient	-40°C ≤ Ta ≤ 85°C		±100		ppm/°C	
I <sub>DD1</sub>	Supply Current 1	A/PV <sub>IN</sub> = V <sub>CE</sub> = 5.5 V, V <sub>OUT</sub> = V <sub>SET</sub> × 0.8		600		μA	
I <sub>DD2</sub>	Supply Current 2	A/PV <sub>IN</sub> = V <sub>CE</sub> = V <sub>OUT</sub> = 5.5 V	V <sub>MODE</sub> = 0 V		48	72	μA
			V <sub>MODE</sub> = 5.5 V		600		μA
I <sub>OUTL</sub>	V <sub>OUT</sub> "L" Current	A/PV <sub>IN</sub> = 5.5 V, V <sub>CE</sub> = V <sub>OUT</sub> = 0 V	-1	0	1	μA	
V <sub>OVD</sub>	OVD Voltage	A/PV <sub>IN</sub> = 3.6 V		V <sub>SET</sub> × 1.2		V	
V <sub>UVD</sub>	UVD Voltage	A/PV <sub>IN</sub> = 3.6 V		V <sub>SET</sub> × 0.8		V	

**RP506Kxx1A/D (Fixed Output Voltage Type without Auto-discharge Function)**

I <sub>OUTH</sub>	V <sub>OUT</sub> "H" Current	A/PV <sub>IN</sub> = V <sub>OUT</sub> = 5.5 V, V <sub>CE</sub> = 0 V	-1	0	1	μA
-------------------	------------------------------	--	----	---	---	----

**RP506Kxx1B/E (Fixed Output Voltage Type with Auto-discharge Function)**

R <sub>LOW</sub>	On Resistance of Low Output	A/PV <sub>IN</sub> = 3.6 V, V <sub>CE</sub> = 0 V		45		Ω
------------------	-----------------------------	---	--	----	--	---

**RP506K001C/F (Adjustable Output Voltage Type) Electrical Characteristics**

V <sub>FB</sub>	Feedback Voltage	A/PV <sub>IN</sub> = V <sub>CE</sub> = 3.6 V	0.591	0.600	0.609	V	
ΔV <sub>FB</sub> /ΔTa	Feedback Voltage Temperature Coefficient	-40°C ≤ Ta ≤ 85°C		±100		ppm/°C	
I <sub>DD1</sub>	Supply Current 1	A/PV <sub>IN</sub> = V <sub>CE</sub> = 5.5 V, V <sub>FB</sub> = 0.48 V		600		μA	
I <sub>DD2</sub>	Supply Current 2	A/PV <sub>IN</sub> = V <sub>CE</sub> = V <sub>FB</sub> = 5.5 V	V <sub>MODE</sub> = 0 V		48	72	μA
			V <sub>MODE</sub> = 5.5 V		600		μA
I <sub>VBH</sub>	V <sub>FB</sub> "H" Current	A/PV <sub>IN</sub> = V <sub>FB</sub> = 5.5 V, V <sub>CE</sub> = 0 V	-1	0	1	μA	
I <sub>VBH</sub>	V <sub>FB</sub> "L" Current	A/PV <sub>IN</sub> = 5.5 V, V <sub>CE</sub> = V <sub>FB</sub> = 0 V	-1	0	1	μA	
V <sub>OVD</sub>	OVD Voltage	A/PV <sub>IN</sub> = 3.6 V		0.72		V	
V <sub>UVD</sub>	UVD Voltage	A/PV <sub>IN</sub> = 3.6 V		0.48		V	

All test items listed under Electrical Characteristics are done under the pulse load condition (T<sub>j</sub> ≈ Ta = 25°C) except Output Voltage Temperature Coefficient and Feedback Voltage Temperature Coefficient.

**ELECTRICAL CHARACTERISTICS (continued)**
**RP506K Electrical Characteristics by Different Output Voltage**

(Ta = 25°C)

Product Name	Output Voltage (V <sub>OUT</sub> ) [V]		
	Min.	Typ.	Max.
RP506K061x	0.582	0.600	0.618
RP506K071x	0.682	0.700	0.718
RP506K081x	0.782	0.800	0.818
RP506K091x	0.882	0.900	0.918
RP506K101x	0.982	1.000	1.018
RP506K111x	1.082	1.100	1.118
RP506K121x	1.182	1.200	1.218
RP506K131x	1.281	1.300	1.319
RP506K141x	1.379	1.400	1.421
RP506K151x	1.478	1.500	1.522
RP506K161x	1.576	1.600	1.624
RP506K171x	1.675	1.700	1.725
RP506K181x	1.773	1.800	1.827
RP506K191x	1.872	1.900	1.928
RP506K201x	1.97	2.000	2.03
RP506K211x	2.069	2.100	2.131
RP506K221x	2.167	2.200	2.233
RP506K231x	2.266	2.300	2.334
RP506K241x	2.364	2.400	2.436
RP506K251x	2.463	2.500	2.537
RP506K261x	2.561	2.600	2.639
RP506K271x	2.66	2.700	2.74
RP506K281x	2.758	2.800	2.842
RP506K291x	2.857	2.900	2.943
RP506K301x	2.955	3.000	3.045
RP506K311x	3.054	3.100	3.146
RP506K321x	3.152	3.200	3.248
RP506K331x	3.251	3.300	3.349
RP506K121x5	1.232	1.250	1.268

## THEORY OF OPERATION

### Soft-start Time Adjustment Function

Soft-start time ( $t_{start}$ ) of the RP506K is adjustable by connecting a soft-start time adjustment capacitor ( $C_{SS}$ ) between the TSS pin and GND.  $t_{start}$  can be set from Typ. 0.15 ms. As Figure 6 shows, if 0.1  $\mu\text{F}$   $C_{SS}$  is connected,  $t_{start}$  will be 30 ms. The TSS pin must be open if the soft-start time function is not used.  $t_{start}$  is set to 0.15 ms (Typ.) when the TSS pin is open.

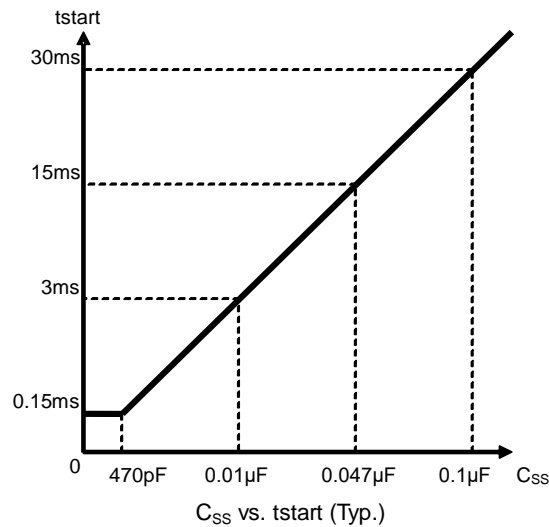

**Soft-start Time ( $t_{start}$ ) vs. Soft-start Time Adjustment Capacitor ( $C_{SS}$ )**

### Power Good Function

The RP506K contains a power good function using Nch open drain. If any abnormal condition is detected, the power good function turns Nch transistor on and switches the PG pin to low. If the cause of the abnormal condition is removed, the power good function turns Nch transistor off and switches the PG pin back to high. After the recovery from abnormal condition, it takes typically 0.05 ms for the IC to turn Nch transistor off. The followings are the abnormal conditions that the power good function can detect.

- CE = "L" (Shut down)
- UVLO (Shut down)
- Thermal Shutdown
- Over Voltage Detection: Typ.  $V_{SET} \times 1.2 \text{ V}$  (RP506Kxx1A/B/D/E) or 0.72 V (RP506K001C/F)
- Under Voltage Detection: Typ.  $V_{SET} \times 0.8 \text{ V}$  (RP506Kxx1A/B/D/E) or 0.48 V (RP506K001C/F)
- Latch Type Protection

Notes: When using the power good function, the resistance of PG pin ( $R_{PG}$ ) should be between 10 k $\Omega$  to 100 k $\Omega$ . The PG pin must be open or connected to GND if the power good function is not used.

### Sequential Start-Up Using Soft-Start Time Adjustment and Power Good Functions

Sequential startup circuits can be built by using soft-start time adjustment and power good functions of the RP506K. The figure below is an example of sequential startup circuits using DC/DC1 and DC/DC2.

The DC/DC1 starts up first followed by the DC/DC2: the output of DC/DC1 reaches 1.44 V ( $V_{SET} \times 0.8$ ), the PG pin of DC/DC1 sends a high signal to the CE pin of DC/DC2, and then the DC/DC2 starts soft-start.

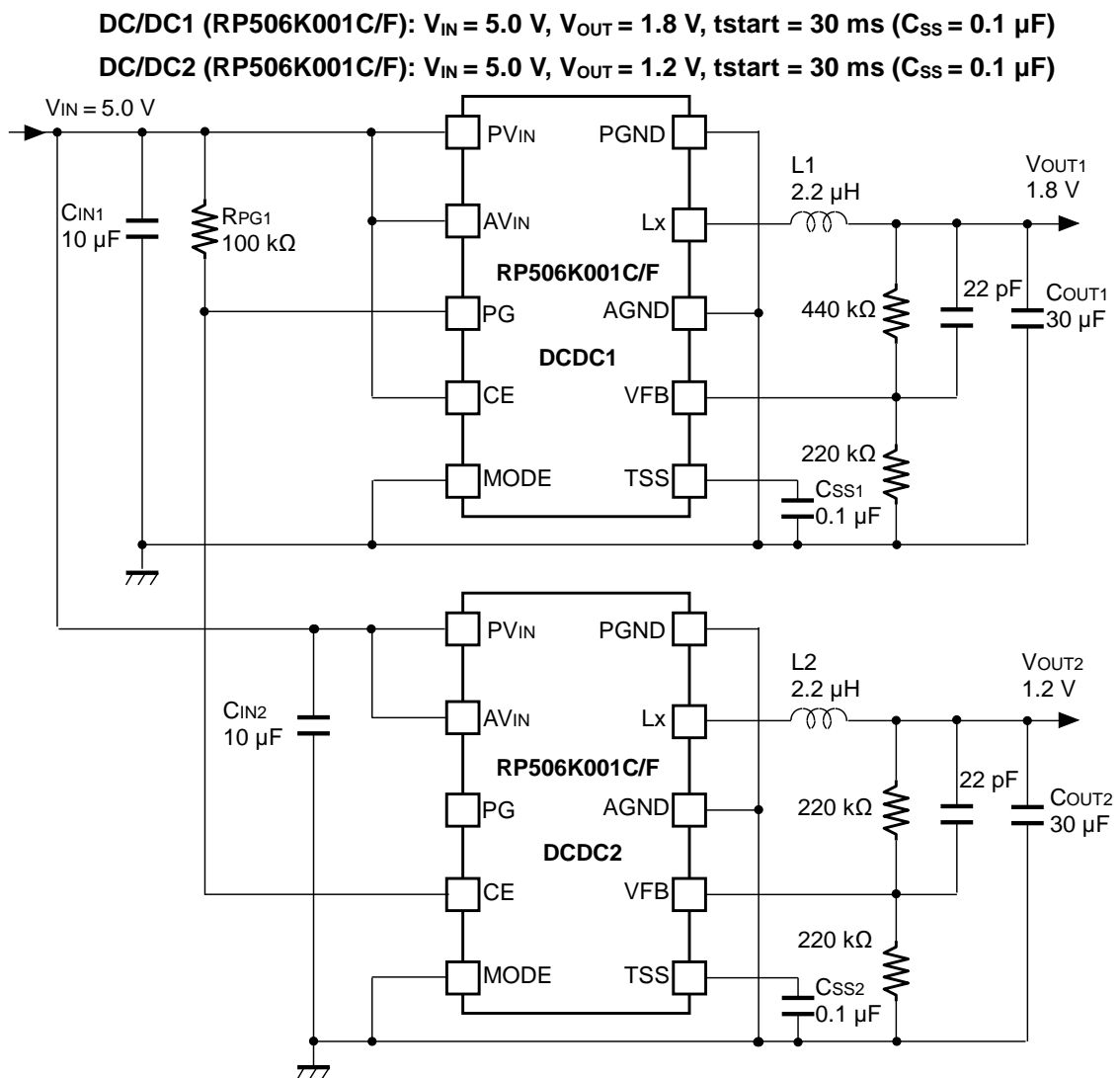

Circuits Example using Sequential Startup

**Operation of Step-Down DC/DC Converter and Output Current**

The step-down DC/DC converter charges energy in the inductor when L<sub>x</sub> Tr. turns "ON", and discharges the energy from the inductor when L<sub>x</sub> Tr. turns "OFF" and controls with less energy loss, so that a lower output voltage (V<sub>OUT</sub>) than the input voltage (V<sub>IN</sub>) can be obtained. The operation of the step-down DC/DC converter is explained in the following figures.

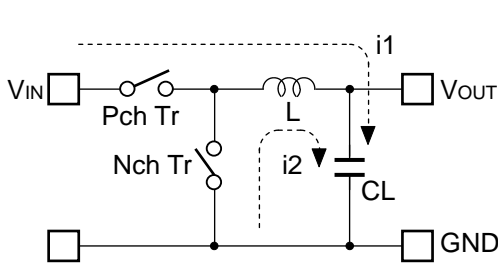

**Basic Circuit**

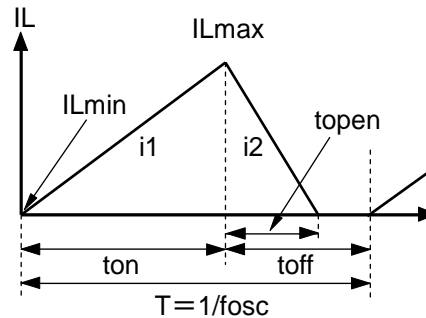

**Inductor Current (IL) flowing through Inductor (L)**

- Step1.** Pch Tr. turns "ON" and IL (i1) flows, L is charged with energy. At this moment, i1 increases from the minimum inductor current (ILmin), which is 0 A, and reaches the maximum inductor current (ILmax) in proportion to the on-time period (ton) of Pch Tr.
- Step2.** When Pch Tr. turns "OFF", L tries to maintain IL at ILmax, so L turns Nch Tr. "ON" and IL (i2) flows into L.
- Step3.** i2 decreases gradually and reaches ILmin after the open-time period (topen) of Nch Tr., and then Nch Tr. turns "OFF". This is called discontinuous current mode.  
As the output current (I<sub>OUT</sub>) increases, the off-time period (toff) of Pch Tr. runs out before IL reaches ILmin. The next cycle starts, and Pch Tr. turns "ON" and Nch Tr. turns "OFF", which means IL starts increasing from ILmin. This is called continuous current mode.

In the case of PWM mode, V<sub>OUT</sub> is maintained by controlling ton. During PWM mode, the oscillator frequency (fosc) is being maintained constant.

When the step-down DC/DC operation is constant, ILmin and ILmax during ton of Pch Tr. would be same as during toff of Pch Tr. The current differential between ILmax and ILmin is described as ΔI.

$$\Delta I = IL_{max} - IL_{min} = V_{OUT} \times topen / L = (V_{IN} - V_{OUT}) \times ton / L \dots \dots \dots \text{Equation 1}$$

However,

$$T = 1 / fosc = ton + toff$$

$$\text{duty (\%)} = ton / T \times 100 = ton \times fosc \times 100$$

$$topen \leq toff$$

In Equation 1, "V<sub>OUT</sub> × topen / L" shows the amount of current change in "OFF" state. Also, "(V<sub>IN</sub> - V<sub>OUT</sub>) × ton / L" shows the amount of current change at "ON" state.

**Discontinuous Mode and Continuous Mode**

As illustrated in Figure A, when  $I_{OUT}$  is relatively small,  $t_{open} < t_{off}$ . In this case, the energy charged into L during  $t_{on}$  will be completely discharged during  $t_{off}$ , as a result,  $I_{Lmin} = 0$ . This is called discontinuous mode. When  $I_{OUT}$  is gradually increased, eventually  $t_{open} = t_{off}$  and when  $I_{OUT}$  is increased further, eventually  $I_{Lmin} > 0$ , as illustrated in Figure B. This is called continuous mode.

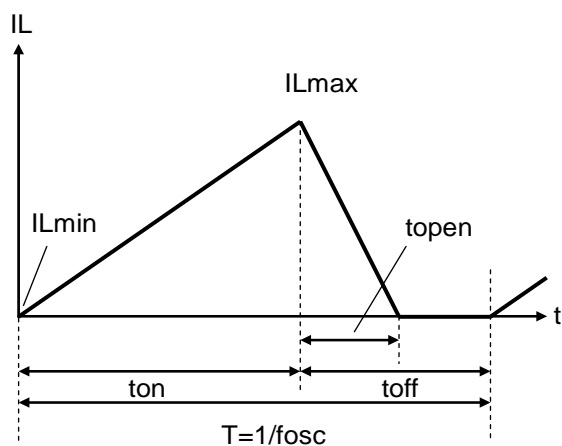

**Figure A. Discontinuous Mode**

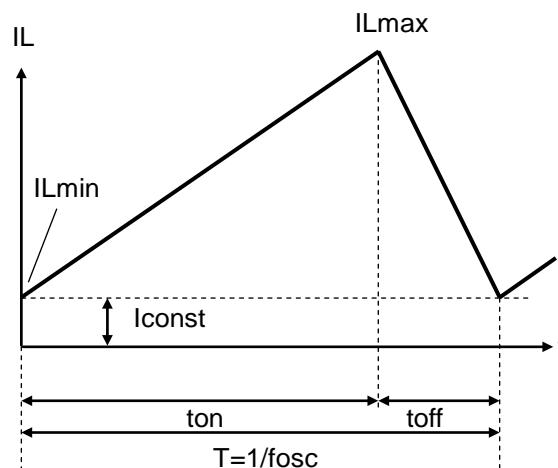

**Figure B. Continuous Mode**

In the continuous mode, the solution of Equation 1 is described as  $t_{onc}$ .

$$t_{onc} = T \times V_{OUT} / V_{IN} \dots\dots\dots \text{Equation 2}$$

When  $t_{on} < t_{onc}$ , it is discontinuous mode, and when  $t_{on} = t_{onc}$ , it is continuous mode.

**Forced PWM Mode**

By setting the MODE pin to "H", the IC switches the frequency at the fixed rate to reduce noise even when the output load is light. Therefore, when  $I_{OUT}$  is  $\Delta I_L/2$  or less,  $I_{Lmin}$  becomes less than 0. That is, the accumulated electricity in CL is discharged through the IC side while  $I_L$  is increasing from  $I_{Lmin}$  to 0 during  $t_{on}$ , and also while  $I_L$  is decreasing from 0 to  $I_{Lmin}$  during  $t_{off}$ .

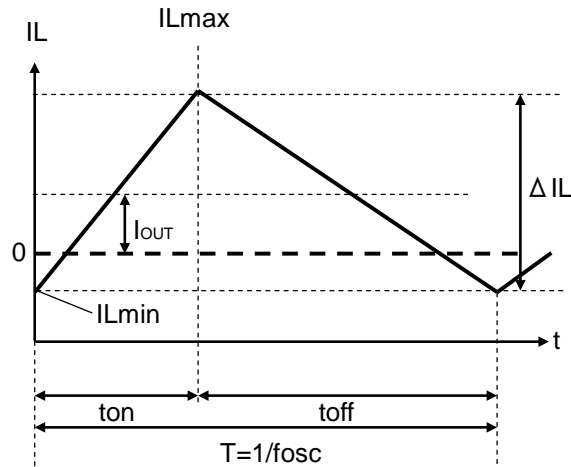
**Forced PWM Mode****VFM Mode**

By setting the MODE pin to "L", in low output current, the IC automatically switches into VFM mode in order to achieve high efficiency. In VFM mode,  $t_{on}$  is forced to end when the inductor current reaches the pre-set  $I_{Lmax}$ . In the VFM mode,  $I_{Lmax}$  is typically set to 400 mA for the RP506Kxx1A/B/C, and 550 mA for the RP506Kxx1D/E/F. When  $t_{on}$  reaches 1.5 times of  $T = 1 / f_{osc}$ ,  $t_{on}$  will be forced to end even if the inductor current is not reached  $I_{Lmax}$ .

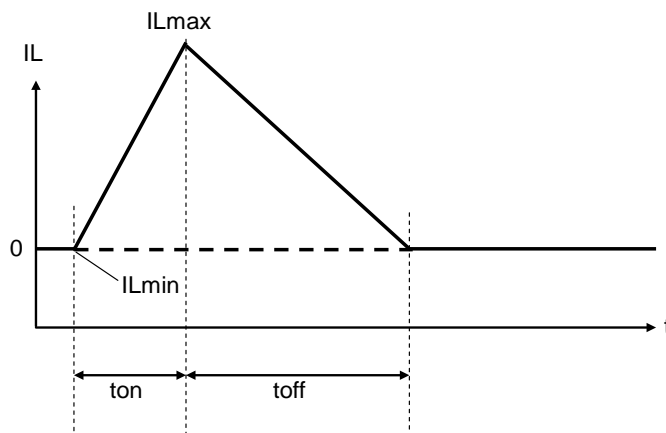
**VFM Mode**



### Output Current and Selection of External Components

The following equations explain the relationship between output current and peripheral components that are listed in *Table 1. Recommended External Components in TYPICAL APPLICATION*.

Ripple Current P-P value is described as  $I_{RP}$ , ON resistance of Pch Tr. is described as  $R_{ONP}$ , ON resistance of Nch Tr. is described as  $R_{ONN}$ , and DC resistor of the inductor is described as  $R_L$ .

First, when Pch Tr. is "ON", the following equation is satisfied.

$$V_{IN} = V_{OUT} + (R_{ONP} + R_L) \times I_{OUT} + L \times I_{RP} / t_{on} \dots\dots\dots \text{Equation 3}$$

Second, when Pch Tr. is "OFF" (Nch Tr. is "ON"), the following equation is satisfied.

$$L \times I_{RP} / t_{off} = R_{ONN} \times I_{OUT} + V_{OUT} + R_L \times I_{OUT} \dots\dots\dots \text{Equation 4}$$

Put Equation 4 into Equation 3 to solve ON duty of Pch Tr. ( $D_{ON} = t_{on} / (t_{off} + t_{on})$ ):

$$D_{ON} = (V_{OUT} + R_{ONN} \times I_{OUT} + R_L \times I_{OUT}) / (V_{IN} + R_{ONN} \times I_{OUT} - R_{ONP} \times I_{OUT}) \dots\dots\dots \text{Equation 5}$$

Ripple Current is described as follows:

$$I_{RP} = (V_{IN} - V_{OUT} - R_{ONP} \times I_{OUT} - R_L \times I_{OUT}) \times D_{ON} / f_{osc} / L \dots\dots\dots \text{Equation 6}$$

Peak current that flows through L, and Lx Tr. is described as follows:

$$I_{Lxmax} = I_{OUT} + I_{RP} / 2 \dots\dots\dots \text{Equation 7}$$

Notes: Please consider  $I_{Lxmax}$  when setting conditions of input and output, as well as selecting the external components. The above calculation formulas are based on the ideal operation of the ICs in continuous mode.

**Timing Chart****(1) Soft-start Time****Starting-up with CE Pin**

The IC starts to operate when the CE pin voltage ( $V_{CE}$ ) exceeds the threshold voltage. The threshold voltage is preset between CE "H" input voltage ( $V_{CEH}$ ) and CE "L" input voltage ( $V_{CEL}$ ).

After the start-of the start-up of the IC, soft-start circuit starts to operate. Then, after a certain period of time, the reference voltage ( $V_{REF}$ ) in the IC gradually increases up to the specified value.

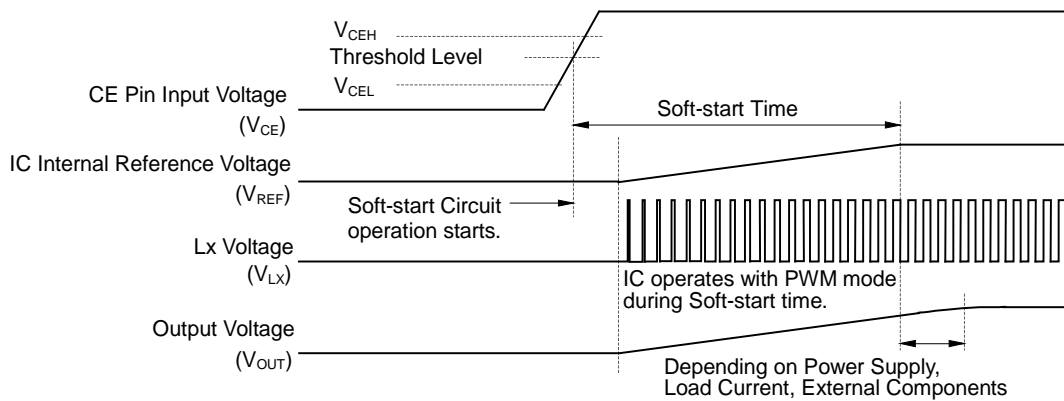
**Timing Chart**

Soft-start time starts when soft-start circuit is activated, and ends when the reference voltage reaches the specified voltage.

Notes: Soft start time is not always equal to the turn-on speed of the step-down DC/DC converter. Please note that the turn-on speed could be affected by the power supply capacity, the output current, the inductance value and the  $C_{OUT}$  value.

### Starting-up with Power Supply

After the power-on, when  $V_{IN}$  exceeds the UVLO released voltage ( $V_{UVLO2}$ ), the IC starts to operate. Then, soft-start circuit starts to operate and after a certain period of time,  $V_{REF}$  gradually increases up to the specified value. Soft-start time starts when soft-start circuit is activated, and ends when  $V_{REF}$  reaches the specified value.

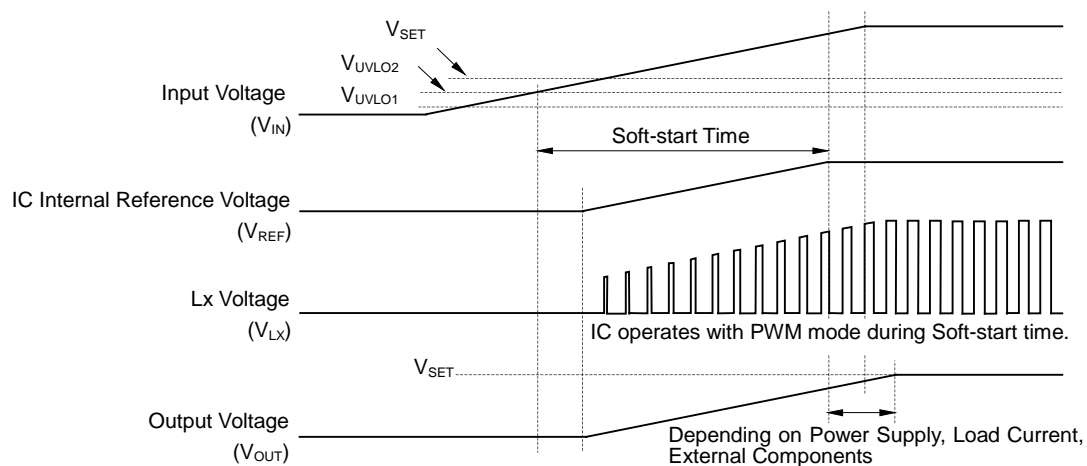

Timing Chart

Notes: Please note that the turn-on speed of  $V_{OUT}$  could be affected by the power supply capacity, the output current, the inductance value, the  $C_{OUT}$  value and the turn-on speed of  $V_{IN}$  determined by  $C_{IN}$ .

**(2) Under Voltage Lockout (UVLO) Circuit**

If  $V_{IN}$  becomes lower than  $V_{SET}$ , the step-down DC/DC converter stops the switching operation and ON duty becomes 100%, and then  $V_{OUT}$  gradually drops according to  $V_{IN}$ .

If the  $V_{IN}$  drops more and becomes lower than the UVLO detector threshold ( $V_{UVLO1}$ ), the UVLO circuit starts to operate,  $V_{REF}$  stops, and Pch and Nch built-in switch transistors turn "OFF". As a result,  $V_{OUT}$  drops according to the  $C_{OUT}$  capacitance value and the load.

To restart the operation,  $V_{IN}$  needs to be higher than  $V_{UVLO2}$ . The timing chart below shows the voltage shifts of  $V_{REF}$ ,  $V_{LX}$  and  $V_{OUT}$  when  $V_{IN}$  value is varied.

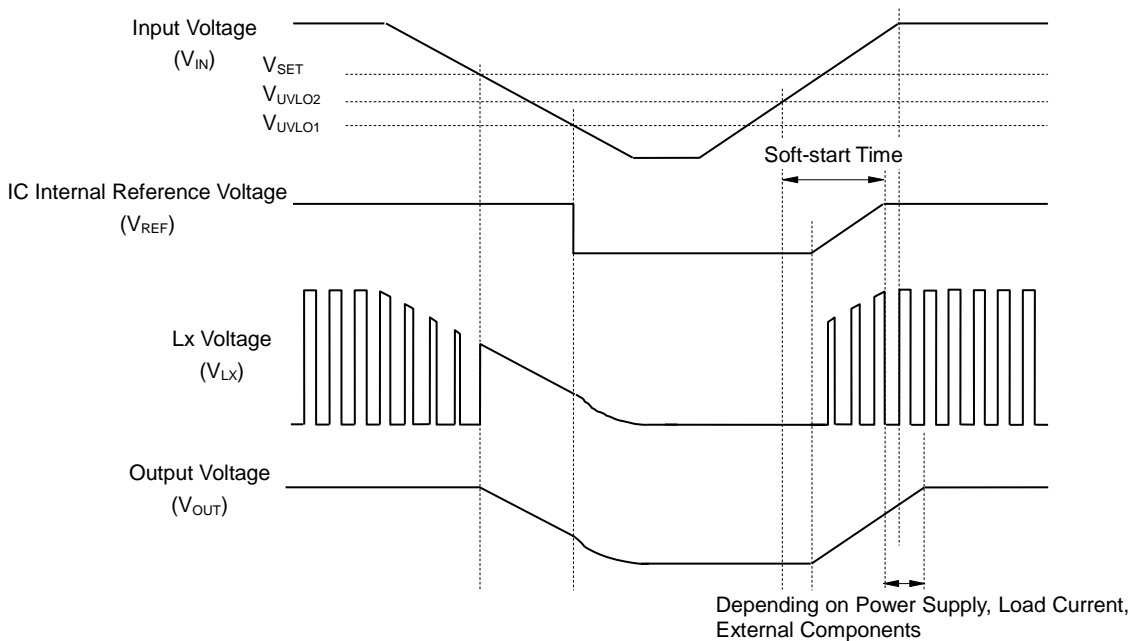
**Timing Chart**

Notes: Falling edge (operating) and rising edge (releasing) waveforms of  $V_{OUT}$  could be affected by the initial voltage of  $C_{OUT}$  and the output current of  $V_{OUT}$ .

**(3) Over Current Protection Circuit, Latch Type Protection Circuit**

Over current protection circuit supervises the inductor peak current (the peak current flowing through Pch Tr.) in each switching cycle, and if the current exceeds the Lx current limit ( $I_{LXLIM}$ ), it turns off Pch Tr.  $I_{LXLIM}$  of the RP506K is set to Typ.2800 mA.

Latch type protection circuit latches the built-in driver to the OFF state and stops the operation of the step-down DC/DC converter if the over current status continues or  $V_{OUT}$  continues being the half of the setting voltage for equal or longer than protection delay time ( $t_{prot}$ ). To release the latch type protection circuit, restart the IC by inputting "L" signal to the CE pin, or restart the IC with power-on or make the supply voltage lower than  $V_{UVLO1}$ .

Notes:  $I_{LXLIM}$  and  $t_{prot}$  could be easily affected by self-heating or ambient environment. If the  $V_{IN}$  drops dramatically or becomes unstable due to short-circuit, protection operation and  $t_{prot}$  could be affected.

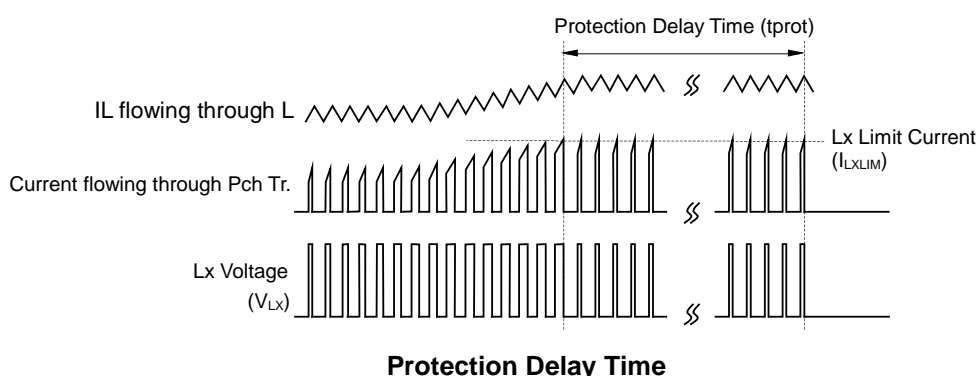

---

**RP506K**

---

No.EA-296-210909

The timing chart below shows the voltage shift of  $V_{CE}$ ,  $V_{LX}$  and  $V_{OUT}$  when the IC status is changed by the following orders:  $V_{IN}$  rising → stable operation → high load → CE reset → stable operation →  $V_{IN}$  falling →  $V_{IN}$  recovering (UVLO reset) → stable operation.

- (1)(2) If the large current flows through the circuit or the IC goes into low  $V_{OUT}$  condition due to short-circuit or other reasons, the latch type protection circuit latches the built-in driver to "OFF" state after  $t_{prot}$ . Then,  $V_{LX}$  becomes "L" and  $V_{OUT}$  turns "OFF".
- (3) The latch type protection circuit is released by CE reset, which puts the IC into "L" once with the CE pin and back into "H".
- (4) The latch type protection circuit is released by UVLO reset, which makes  $V_{IN}$  lower than  $V_{UVLO1}$ .

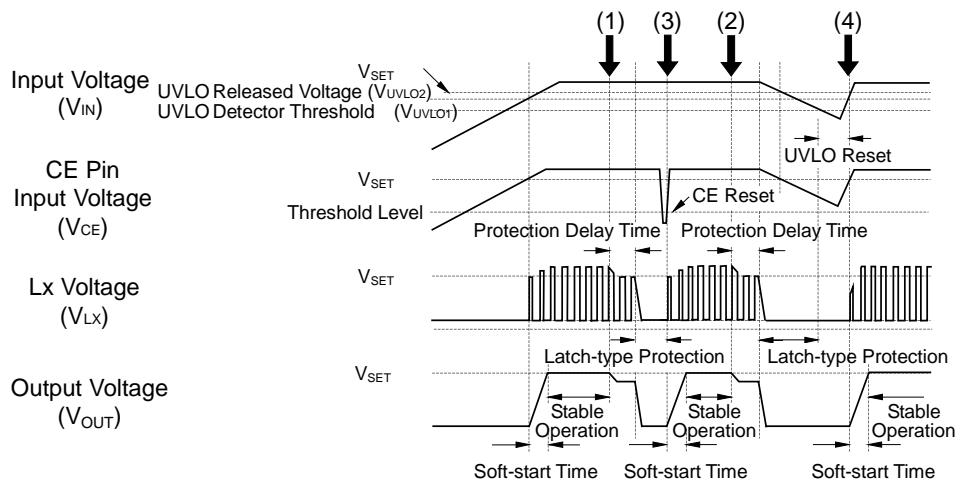
**Timing Chart**

## APPLICATION INFORMATION

### Typical Application

PG function is used, 30 ms Soft-start Time

\*1 MODE = "H": forced PWM control, MODE = "L": PWM/VFM auto switching control

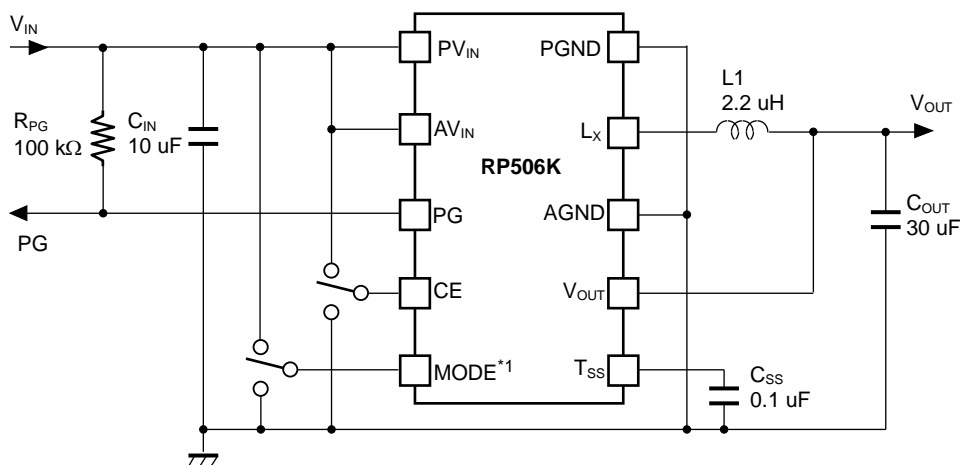

RP506Kxx1A/B/D/E (Fixed Output Voltage Type)

PG function is not used, 150 μs Soft-start Time

\*1 MODE = "H": forced PWM control, MODE = "L": PWM/VFM auto switching control

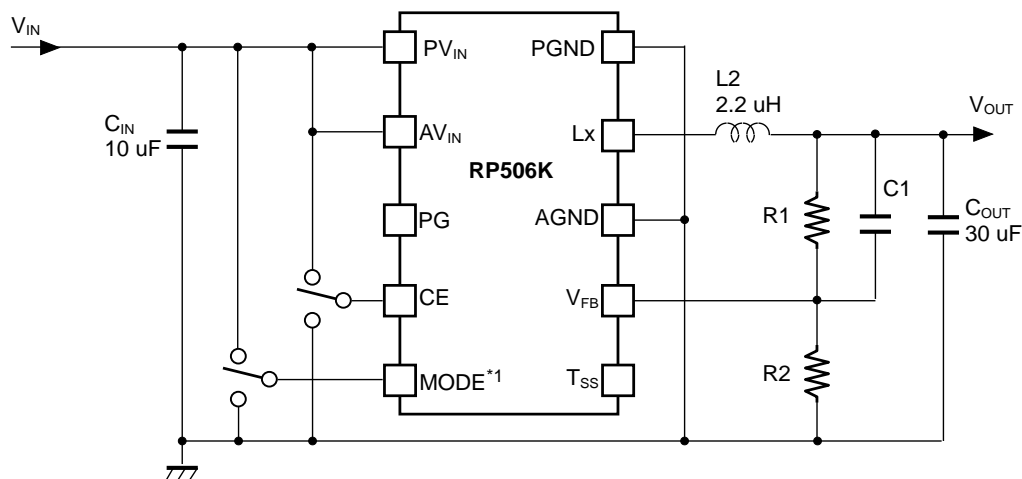

RP506K001C/F (Adjustable Output Voltage Type)

---

**RP506K**

---

No.EA-296-210909

**Table 1. Recommended External Components**

Symbol	Size	Part Description	Model
$C_{IN}$	10 $\mu$ F	Ceramic Capacitor	C1608JB0J106M (TDK)
			JMK107BJ106MA (Taiyo Yuden)
$C_{OUT}$	22 $\mu$ F x 2	Ceramic Capacitor	C2012JB0J226M (TDK)
	10 $\mu$ F x 3	Ceramic Capacitor	C1608JB0J106M (TDK) JMK107BJ106MA (Taiyo Yuden)
$L$ ( $V_{SET} \leq 3.3V$ )	2.2 $\mu$ H	Inductor	SLF6045T-2R2N3R3 (TDK)
			CLF7045T-2R2N (TDK)
			FSD0415-2R2M (TOKO)
			RLF7030T-2R2M5R4 (TDK)
$L$ ( $V_{SET} > 3.3V$ ) <sup>(1)</sup>	4.7 $\mu$ H	Inductor	SLF6045T-4R7N2R4 (TDK)
			CLF7045T-4R7N (TDK)
			FSD0415-4R7M (TOKO)
			RLF7030T-4R7M3R4 (TDK)

**Small and Low Profile External Components**

Symbol	Size	Part Description	Model
$L$ ( $V_{SET} \leq 1.5V$ )	1.0 $\mu$ H	Inductor	DFE252010R-H-1R0M (TOKO)
			VLS252010HBX-1R0M (TDK)
$L$ ( $V_{SET} \leq 2.3V$ )	1.5 $\mu$ H	Inductor	DFE252010R-H-1R5M (TOKO)
			VLS252010HBX-1R5M (TDK)
$L$	2.2 $\mu$ H	Inductor	DFE252010R-H-2R2M (TOKO)
			VLS252010HBX-2R2M (TDK)

---

<sup>(1)</sup> Only for RP506K001C/F

---



## TECHNICAL NOTES

The performance of power source circuits using this IC largely depends on peripheral circuits. When selecting the peripheral components, please consider the conditions of use. Do not allow each component, PCB pattern or the IC to exceed their respected rated values (voltage, current, and power) when designing the peripheral circuits.

- AGND and PGND must be wired to the GND plane when mounting on boards.
- AV<sub>IN</sub> and PV<sub>IN</sub> must be wired to the V<sub>IN</sub> plane when mounting on boards.
- Ensure the A/PV<sub>IN</sub> and A/PGND lines are sufficiently robust. A large switching current flows through the A/ PGND line, the V<sub>DD</sub> line, the V<sub>OUT</sub> line, an inductor, and L<sub>x</sub>. If their impedance is too high, noise pickup or unstable operation may result. Set the external components as close as possible to the IC and minimize the wiring between the components and the IC. Especially, place a capacitor (C<sub>IN</sub>) as close as possible to the PV<sub>IN</sub> pin and PGND. For the RP506Kxx1A/B/D/E, separate the wiring between the V<sub>OUT</sub> pin and an inductor (L1) from the wiring between L1 and Load. Likewise, for the RP506K001C/F, separate the wiring between a resistor for setting output voltage (R1) and an inductor (L2) from the wiring between L2 and Load.
- Choose a low ESR ceramic capacitor. The ceramic capacitance of C<sub>IN</sub> should be more than or equal to 10 μF. For a ceramic capacitor (C<sub>OUT</sub>), it is recommended that three paralleled 10 μF ceramic capacitors or two paralleled 22 μF ceramic capacitors be used.
- When V<sub>SET</sub> ≤ 3.3 V, a 2.2 μH inductor is recommended for RP506Kxx1A/B/C/D/E/F. When V<sub>SET</sub> ≤ 2.3 V, a 1.5 μH inductor can be used for RP506Kxx1A/B/C. When V<sub>SET</sub> ≤ 1.5 V, a 1 μH inductor can be used for RP506Kxx1A/B/C. When V<sub>SET</sub> > 3.3 V, a 4.7 μH inductor is recommended for RP506K001C/F. The phase compensation of this IC is designed according to the C<sub>OUT</sub> and L values. Choose an inductor that has small DC resistance, has enough allowable current and is hard to cause magnetic saturation. If the inductance value of an inductor is extremely small, the peak current of L<sub>x</sub> may increase along with the load current. As a result, over current protection circuit may start to operate when the peak current of L<sub>x</sub> reaches to “L<sub>x</sub> limit current”.

### Set Output Voltage Range vs. Inductance Range

Version	RP506Kxx1A/B			RP506Kxx1D/E
	L = 1.0 μH	L = 1.5 μH	L = 2.2 μH	L = 2.2 μH
up to 1.5	Acceptable	Acceptable	Recommended	Recommended
1.6 to 2.3	-	Acceptable	Recommended	Recommended
2.4 to 3.3	-	-	Recommended	Recommended

Version	RP506K001C				RP506K001F	
	L = 1.0 μH	L = 1.5 μH	L = 2.2 μH	L = 4.7 μH	L = 2.2 μH	L = 4.7 μH
up to 1.5	Acceptable	Acceptable	Recommended	-	Recommended	-
1.6 to 2.3	-	Acceptable	Recommended	-	Recommended	-
2.4 to 3.3	-	-	Recommended	-	Recommended	-
3.4 or more	-	-	-	Recommended	-	Recommended

---

## RP506K

---

No.EA-296-210909

- Over current protection circuit and latch type protection circuit may be affected by self-heating or power dissipation environment.
- The output voltage ( $V_{SET}$ ) is adjustable by changing the resistance values of resistors (R1, R2) as follows.

$$V_{SET} = V_{FB} \times (R1 + R2) / R2 \text{ (Recommended } V_{OUT} \text{ range for RP506K001F: } 0.6 \text{ V} \leq V_{SET} \leq 4.0 \text{ V)}$$
$$\text{(Recommended } V_{OUT} \text{ range for RP506K001C: } 0.8 \text{ V} \leq V_{SET} \leq 4.0 \text{ V)}$$

If R1 and R2 are too large, the impedances of  $V_{FB}$  also become large, as a result, the IC could be easily affected by noise. For this reason, R2 should be 220 k $\Omega$  or less. If the operation becomes unstable due to the high impedances, the impedances should be decreased.

C1 can be calculated by the following equations. Please use the value close to the calculation result.

If the output voltage is lower than or equal to 3.3 V:

$$C1 = 4.84 \times 10^{-6} / R2 \text{ [F]}$$

If the output voltage exceeds 3.3 V:

$$C1 = 1.50 \times 10^{-6} / R2 \text{ [F]}$$

The recommended resistance values for R1 and C1 when R2 = 220 k $\Omega$  or 100 k $\Omega$  are as follows.

### Set Output Voltage ( $V_{SET}$ ) vs. Resistors (R1, R2) and Capacitor (C1)

$V_{SET}$ [V]	0.6	0.7	0.8	1.2	1.8	2.5	3.3	3.8	4.0
R1 [k $\Omega$ ]	0	36.7	73.3	220	440	697	990	533	567
R2 [k $\Omega$ ]	220	220	220	220	220	220	220	100	100
C1 [pF]	-	22	22	22	22	22	22	15	15

- Soft-start Time ( $t_{start}$ ) is adjustable by connecting a capacitor ( $C_{SS}$ ) between the TSS pin and GND. The capacitance value for  $C_{SS}$  that is suitable for  $t_{start}$  can be calculated by the following equation.

$$C_{SS} \text{ (nF)} = 3.5 \times t_{start} \text{ (ms)}$$

The TSS pin must be open if Soft-start time function is not used. Soft-start time is set to typically 150  $\mu$ s when the TSS pin is open.

- When using the power good function, the resistance value of a resistor ( $R_{PG}$ ) should be between 10 k $\Omega$  to 100 k $\Omega$ . The PG pin must be open or connected to GND if the power good function is not used.

Reference PCB Layouts

RP506xxxA/B/D/E (PKG: DFN(PLP)2527-10pin) PCB Layout

Topside

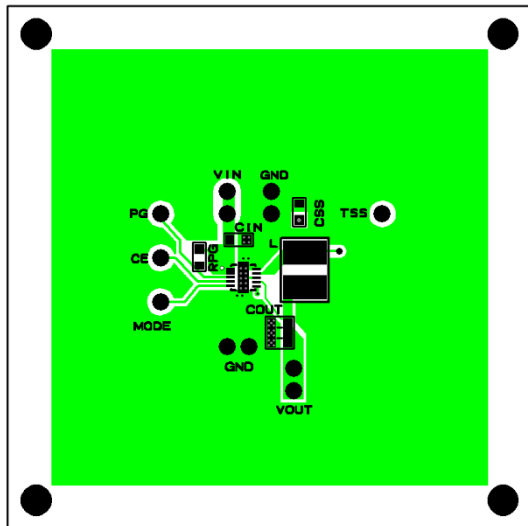

Backside

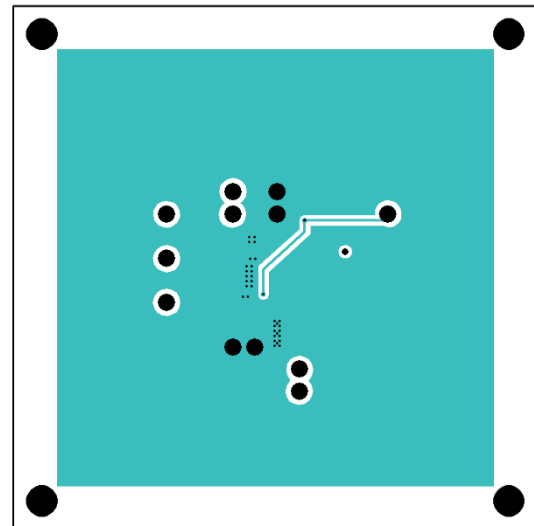

RP506K001C/F (PKG: DFN(PLP)2527-10pin) PCB Layout

Topside

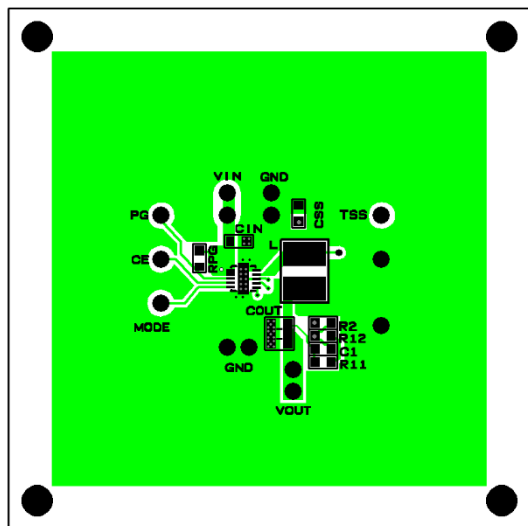

Backside

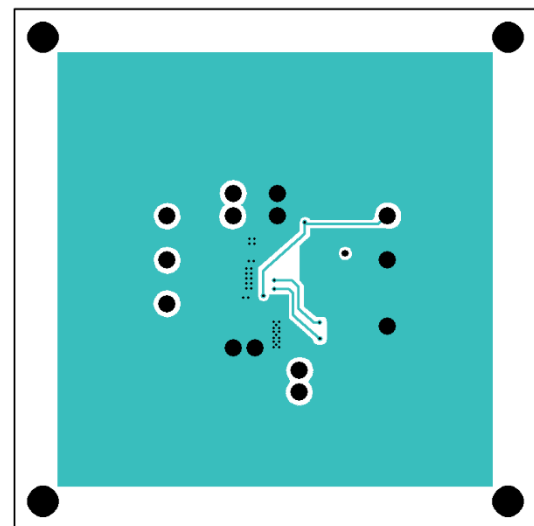

\* R11 and R12 are arranged as a substitute for R1 so that two resistors can be connected in series.

**TYPICAL PERFORMANCE CHARACTERISTICS**

Note: Typical Characteristics are intended to be used as reference data; they are not guaranteed.

**1) Output Voltage vs. Output Current**

**RP506Kxx1A/B/C  $V_{OUT} = 1.2\text{ V}$   
MODE = "L" PWM/VFM Auto Switching Control**

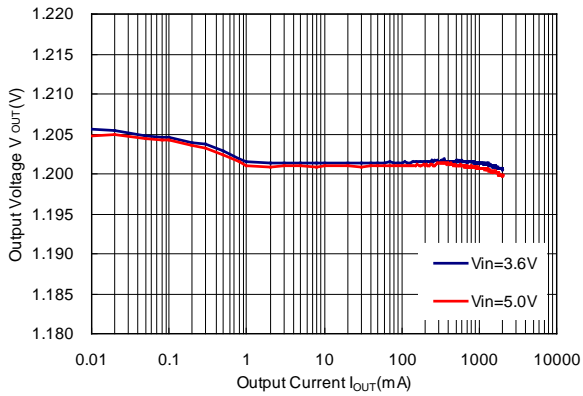

**RP506Kxx1A/B/C  $V_{OUT} = 1.2\text{ V}$   
MODE = "H" Forced PWM Control**

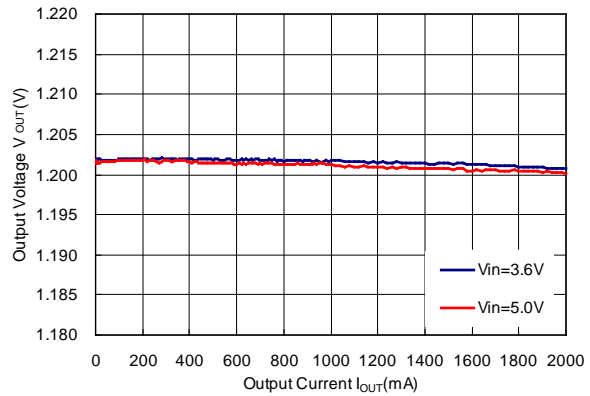

**RP506Kxx1A/B/C  $V_{OUT} = 1.8\text{ V}$   
MODE = "L" PWM/VFM Auto Switching Control**

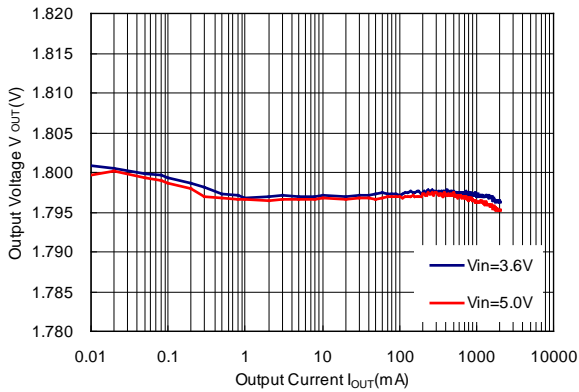

**RP506Kxx1A/B/C  $V_{OUT} = 1.8\text{ V}$   
MODE = "H" Forced PWM Control**

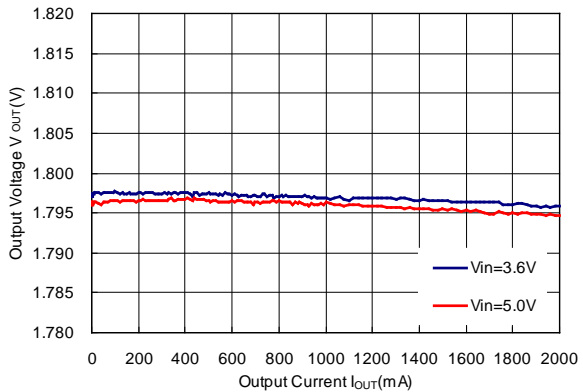

**RP506Kxx1A/B/C  $V_{OUT} = 3.3\text{ V}$   
MODE = "L" PWM/VFM Auto Switching Control**

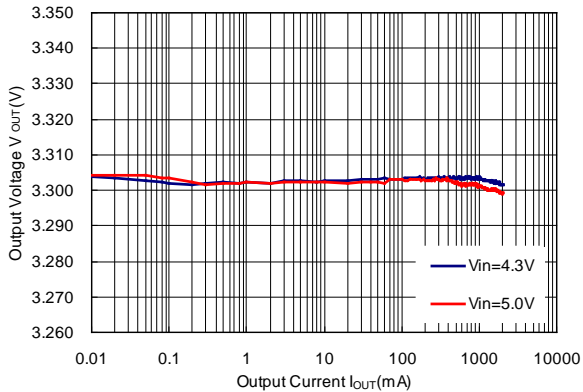

**RP506Kxx1A/B/C  $V_{OUT} = 3.3\text{ V}$   
MODE = "H" Forced PWM Control**

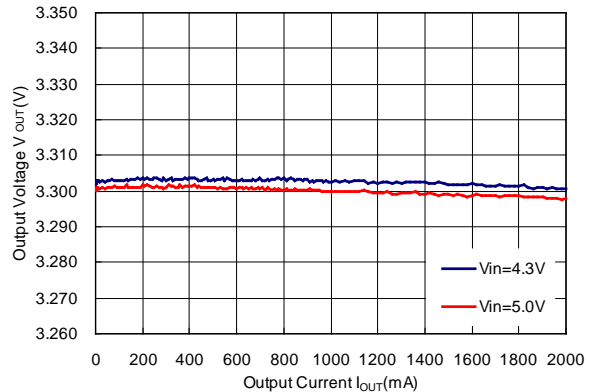

**RP506Kxx1D/E/F  $V_{OUT} = 0.6\text{ V}$**   
**MODE = "L" PWM/VFM Auto Switching Control**

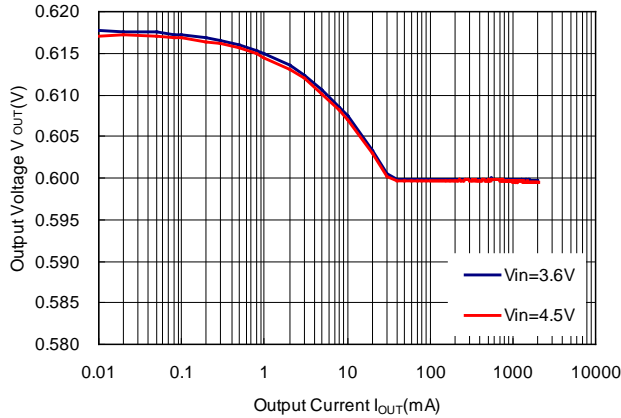

**RP506Kxx1D/E/F  $V_{OUT} = 0.6\text{ V}$**   
**MODE = "H" Forced PWM Control**

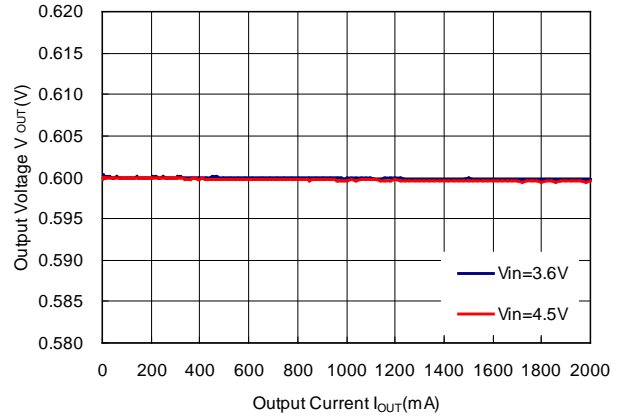

**RP506Kxx1D/E/F  $V_{OUT} = 0.8\text{ V}$**   
**MODE = "L" PWM/VFM Auto Switching Control**

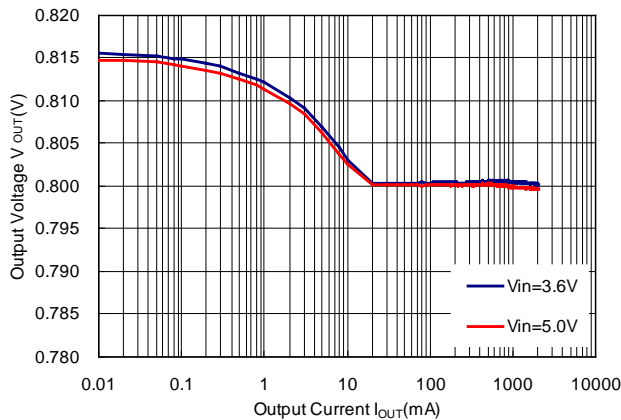

**RP506Kxx1D/E/F  $V_{OUT} = 0.8\text{ V}$**   
**MODE = "H" Forced PWM Control**

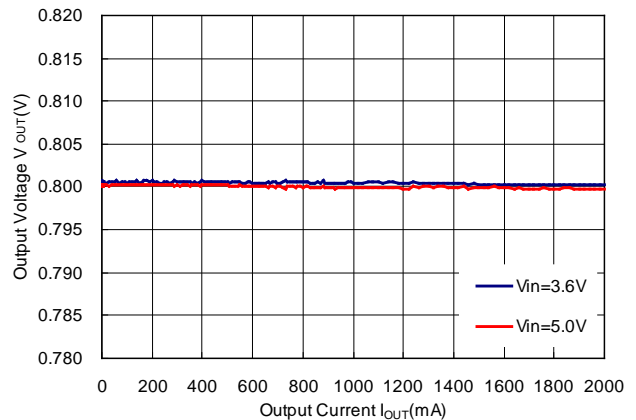

**RP506Kxx1D/E/F  $V_{OUT} = 1.2\text{ V}$**   
**MODE = "L" PWM/VFM Auto Switching Control**

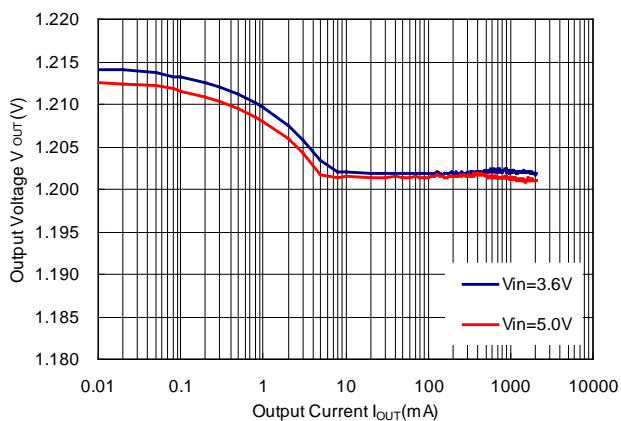

**RP506Kxx1D/E/F  $V_{OUT} = 1.2\text{ V}$**   
**MODE = "H" Forced PWM Control**

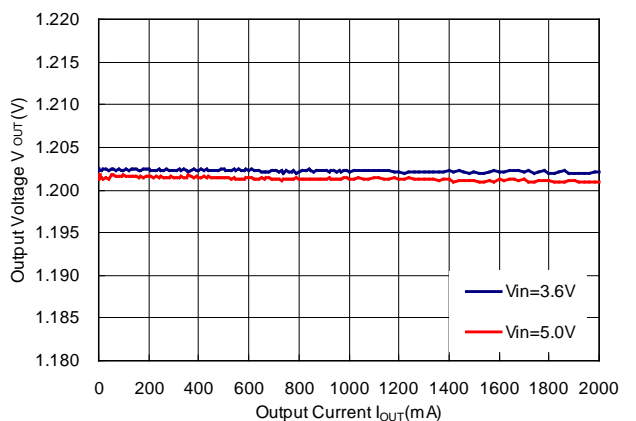

# RP506K

No.EA-296-210909

**RP506Kxx1D/E/F  $V_{OUT} = 1.8\text{ V}$**   
**MODE = "L" PWM/VFM Auto Switching Control**

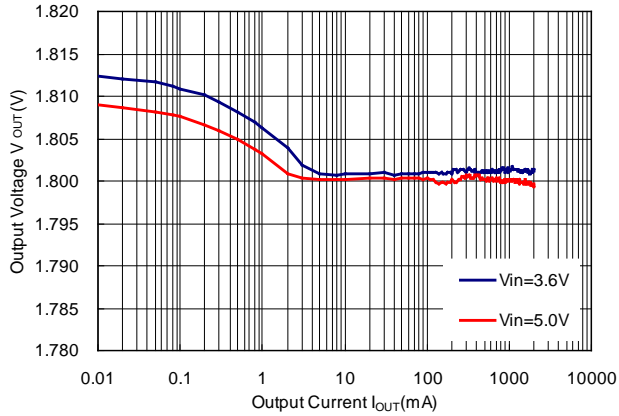

**RP506Kxx1D/E/F  $V_{OUT} = 1.8\text{ V}$**   
**MODE = "H" Forced PWM Control**

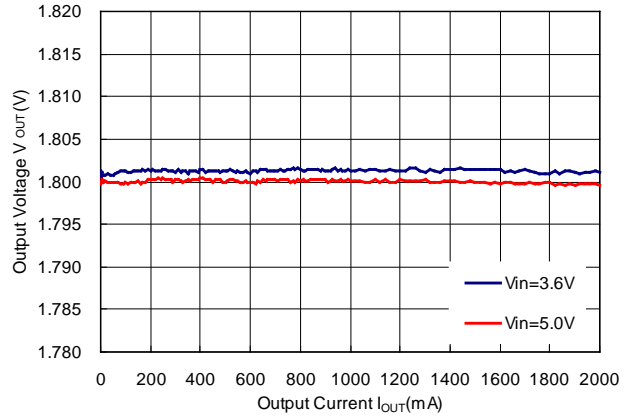

**RP506Kxx1D/E/F  $V_{OUT} = 3.3\text{ V}$**   
**MODE = "L" PWM/VFM Auto Switching Control**

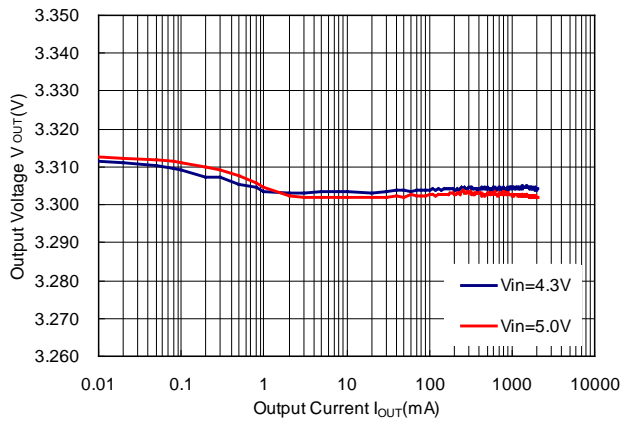

**RP506Kxx1D/E/F  $V_{OUT} = 3.3\text{ V}$**   
**MODE = "H" Forced PWM Control**

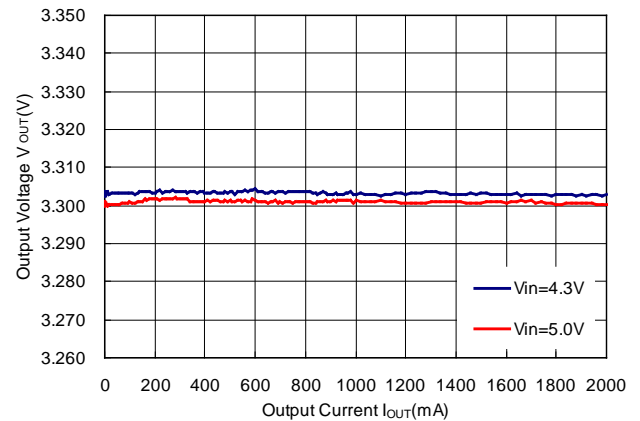

## 2) Output Voltage vs. Input Voltage

**RP506Kxx1D/E/F  $V_{OUT} = 0.6\text{ V}$**   
**MODE = "H" Forced PWM Control**

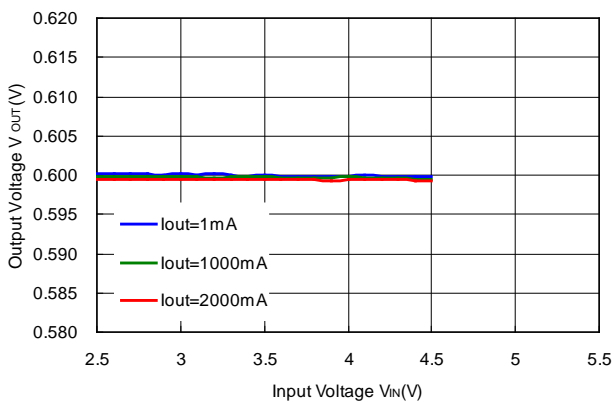

**RP506Kxx1D/E/F  $V_{OUT} = 0.8\text{ V}$**   
**MODE = "H" Forced PWM Control**

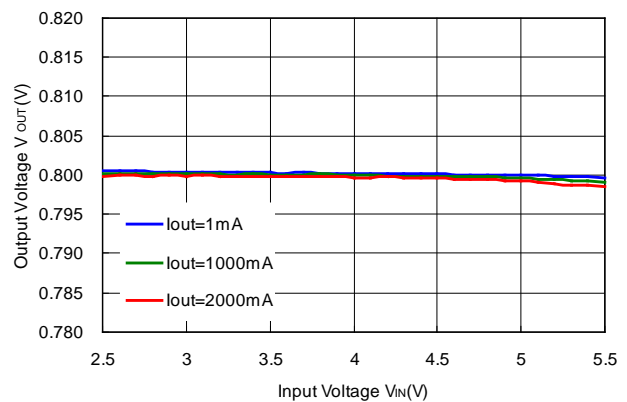

**RP506K  $V_{OUT} = 1.2\text{ V}$   
MODE = "H" Forced PWM Control**

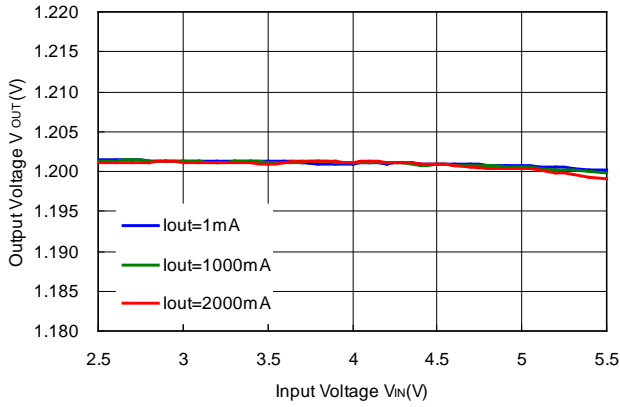

**RP506K  $V_{OUT} = 1.8\text{ V}$   
MODE = "H" Forced PWM Control**

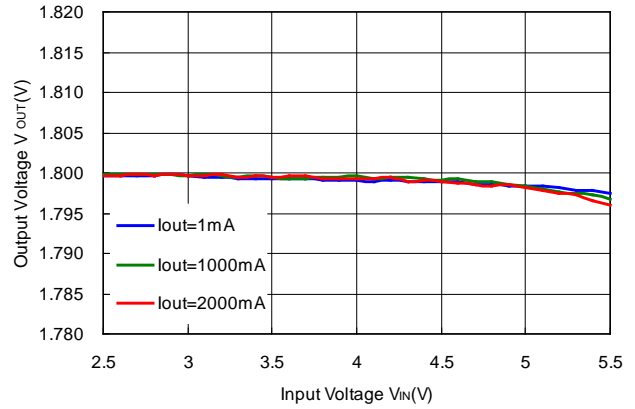

**RP506K  $V_{OUT} = 3.3\text{ V}$   
MODE = "H" Forced PWM Control**

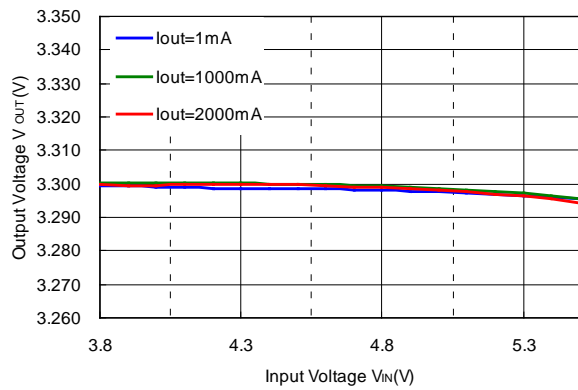

**3) Output Voltage vs. Ambient Temp.**

**RP506K181A/B/D/E  $V_{OUT} = 1.8\text{ V}$**

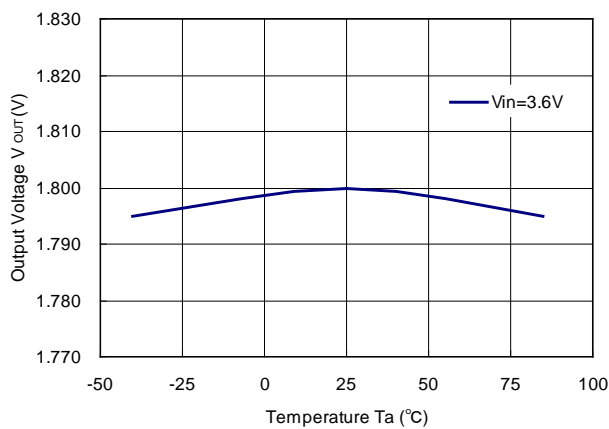

**4) Feedback Voltage vs. Ambient Temp.**

**RP506K001C/F**

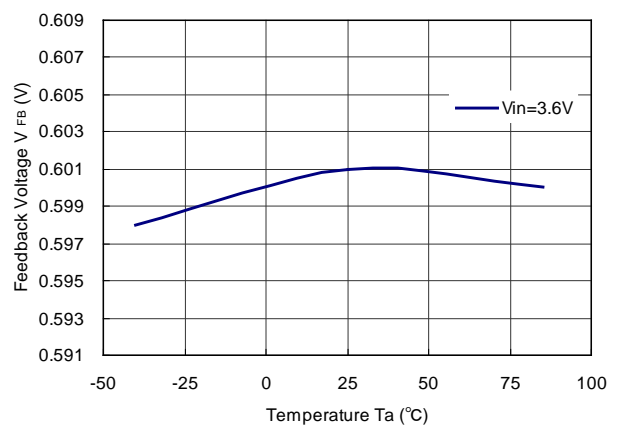

# RP506K

No.EA-296-210909

## 5) Efficiency vs. Output Current

RP506Kxx1A/B/C  $V_{OUT} = 1.2\text{ V}$

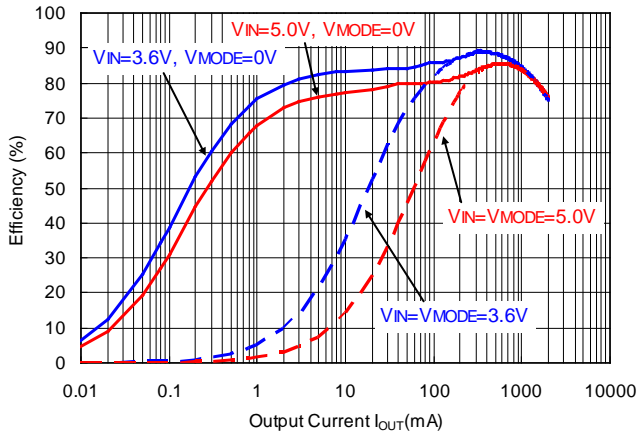

RP506Kxx1A/B/C  $V_{OUT} = 1.8\text{ V}$

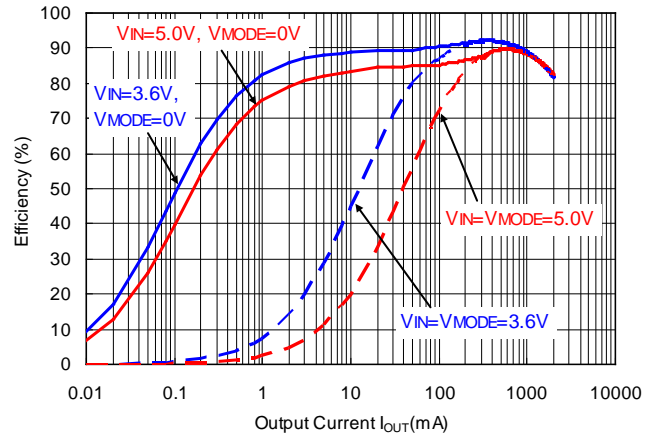

RP506Kxx1A/B/C  $V_{OUT} = 3.3\text{ V}$

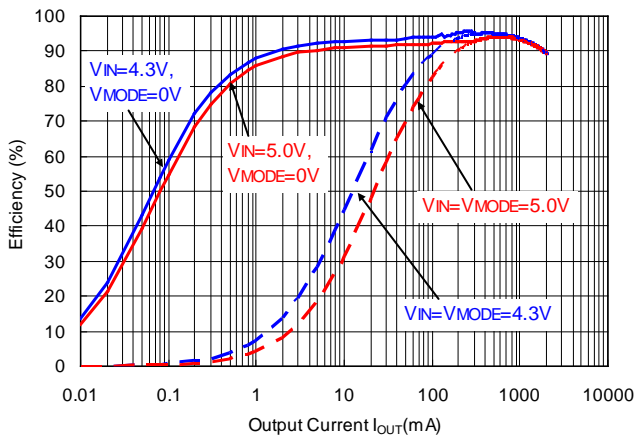

RP506Kxx1D/E/F  $V_{OUT} = 0.6\text{ V}$

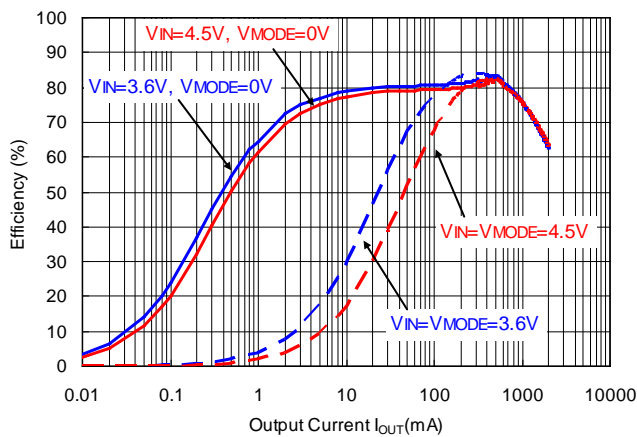

RP506Kxx1D/E/F  $V_{OUT} = 0.8\text{ V}$

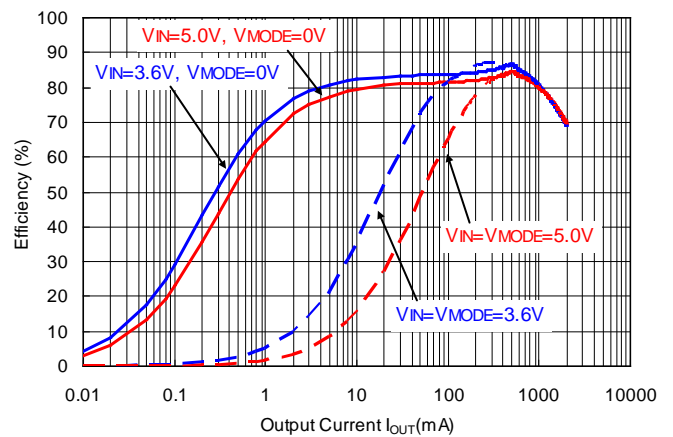



RP506Kxx1D/E/F  $V_{OUT} = 1.2\text{ V}$

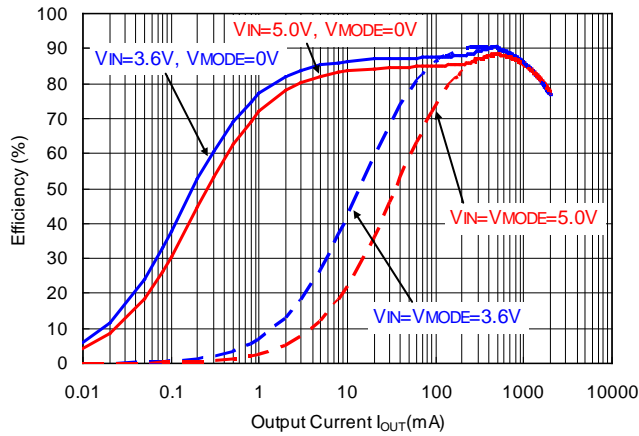

RP506Kxx1D/E/F  $V_{OUT} = 1.8\text{ V}$

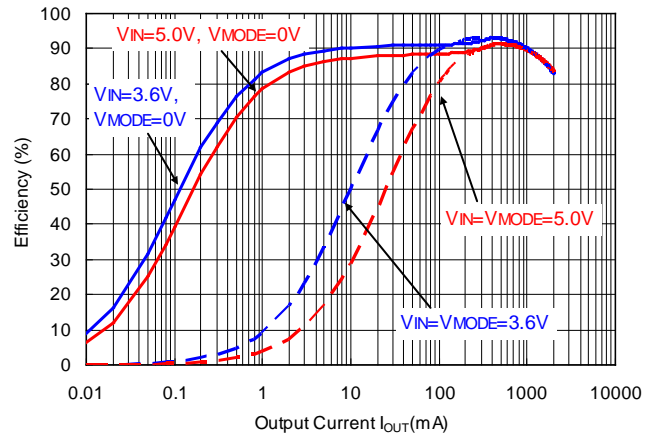

RP506Kxx1D/E/F  $V_{OUT} = 3.3\text{ V}$

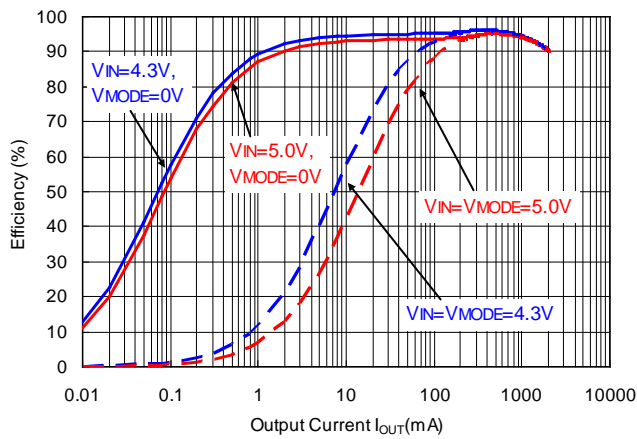

6) Supply Current vs. Ambient Temp.

RP506K  $V_{OUT} = 1.8\text{ V}$  ( $V_{IN} = 5.5\text{ V}$ )

MODE = "L" PWM/VFM Auto Switching Control

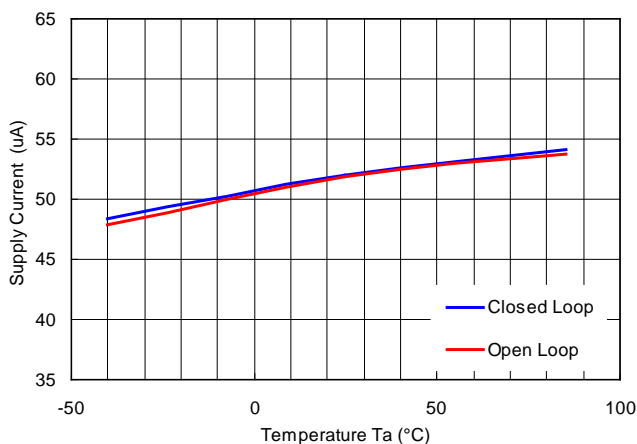

7) Supply Current vs. Input Voltage

RP506K  $V_{OUT} = 1.8\text{ V}$

MODE = "L" PWM/VFM Auto Switching Control

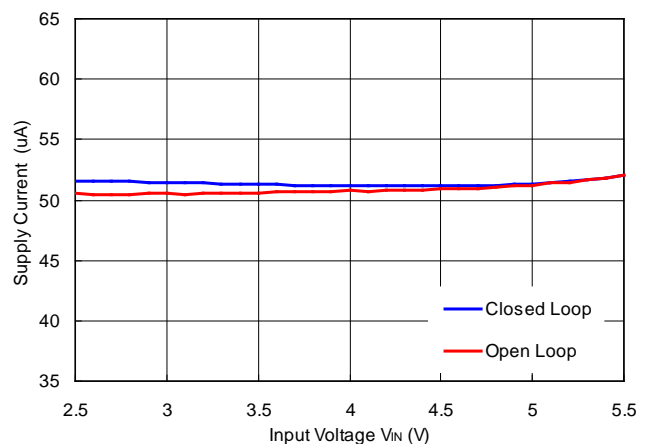

---

# RP506K

---

No.EA-296-210909

## 8) Output Voltage Waveform

RP506Kxx1A/B/C  $V_{OUT} = 0.8\text{ V}$  ( $V_{IN} = 3.6\text{ V}$ )  
MODE = "L" PWM/VFM Auto Switching Control

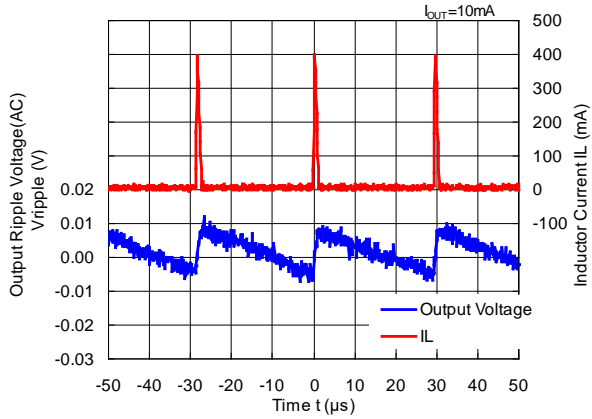

RP506Kxx1A/B/C  $V_{OUT} = 1.2\text{ V}$  ( $V_{IN} = 3.6\text{ V}$ )  
MODE = "L" PWM/VFM Auto Switching Control

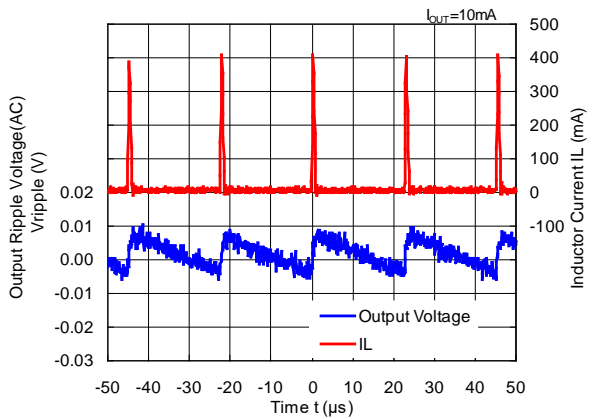

RP506Kxx1A/B/C  $V_{OUT} = 1.2\text{ V}$  ( $V_{IN} = 3.6\text{ V}$ )  
MODE = "H" Forced PWM Control

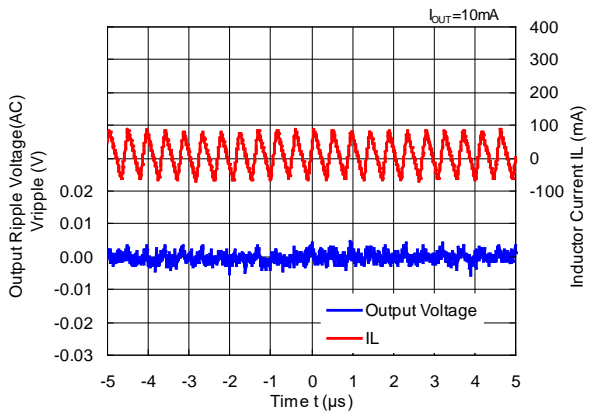

RP506Kxx1A/B/C  $V_{OUT} = 1.8\text{ V}$  ( $V_{IN} = 3.6\text{ V}$ )  
MODE = "L" PWM/VFM Auto Switching Control

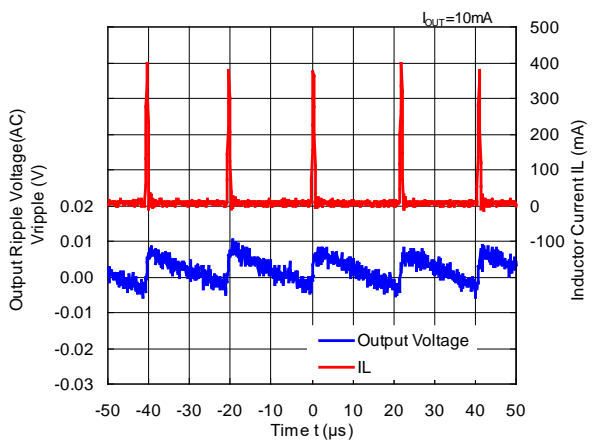

RP506Kxx1A/B/C  $V_{OUT} = 1.8\text{ V}$  ( $V_{IN} = 3.6\text{ V}$ )  
MODE = "H" Forced PWM Control

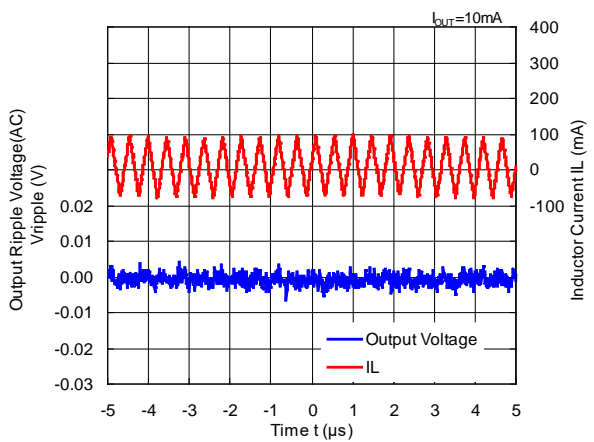

**RP506Kxx1A/B/C**  $V_{OUT} = 3.3\text{ V}(V_{IN} = 5.0\text{ V})$   
**MODE = "L" PWM/VFM Auto Switching Control**

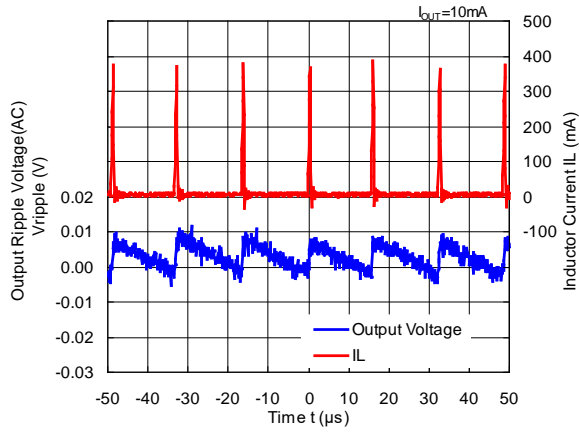

**RP506Kxx1A/B/C**  $V_{OUT} = 1.8\text{ V}(V_{IN} = 5.0\text{ V})$   
**MODE = "H" Forced PWM Control**

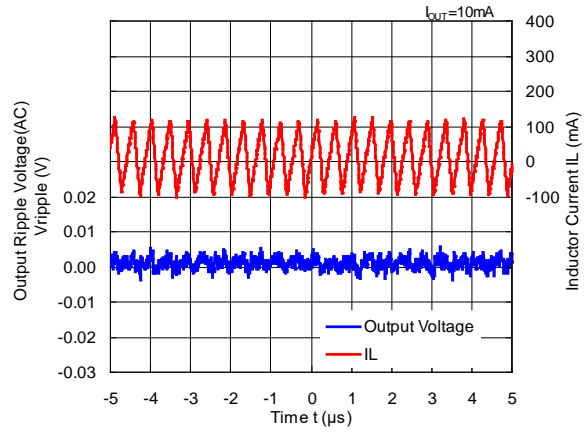

**RP506Kxx1D/E/F**  $V_{OUT} = 0.6\text{ V}(V_{IN} = 3.6\text{ V})$   
**MODE = "L" PWM/VFM Auto Switching Control**

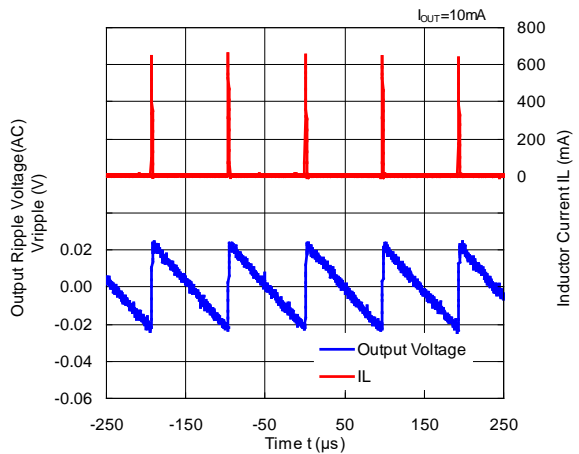

**RP506Kxx1D/E/F**  $V_{OUT} = 0.6\text{ V}(V_{IN} = 3.6\text{ V})$   
**MODE = "H" Forced PWM Control**

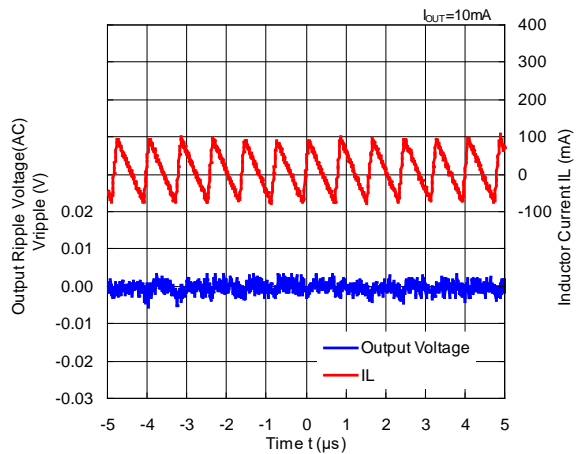

**RP506Kxx1D/E/F**  $V_{OUT} = 0.8\text{ V}(V_{IN} = 3.6\text{ V})$   
**MODE = "L" PWM/VFM Auto Switching Control**

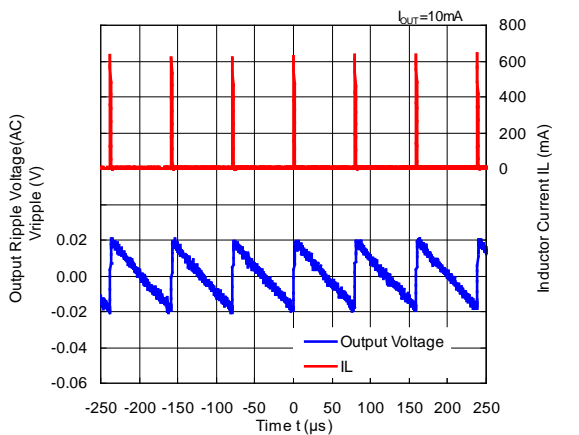

**RP506Kxx1D/E/F**  $V_{OUT} = 0.8\text{ V}(V_{IN} = 3.6\text{ V})$   
**MODE = "H" Forced PWM Control**

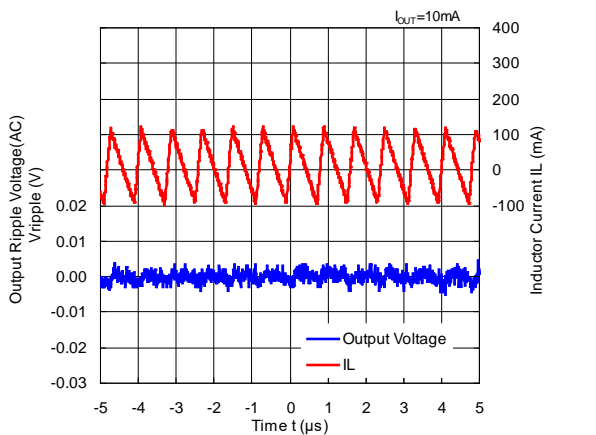

# RP506K

No.EA-296-210909

**RP506Kxx1D/E/F  $V_{OUT} = 1.2\text{ V}$  ( $V_{IN} = 3.6\text{ V}$ )  
MODE = "L" PWM/VFM Auto Switching Control**

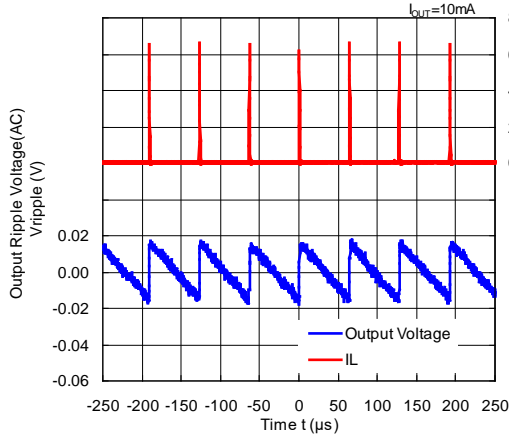

**RP506Kxx1D/E/F  $V_{OUT} = 1.2\text{ V}$  ( $V_{IN} = 3.6\text{ V}$ )  
MODE = "H" Forced PWM Control**

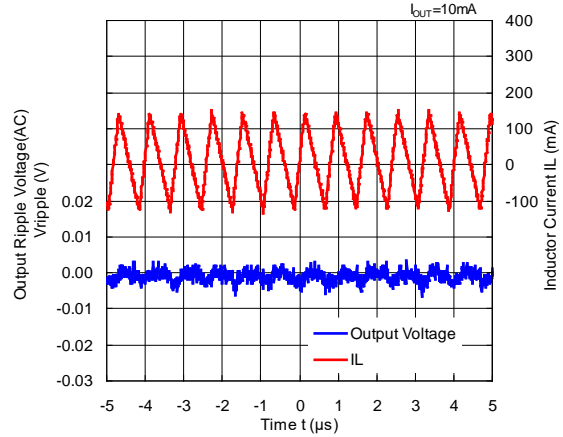

**RP506Kxx1D/E/F  $V_{OUT} = 1.8\text{ V}$  ( $V_{IN} = 3.6\text{ V}$ )  
MODE = "L" PWM/VFM Auto Switching Control**

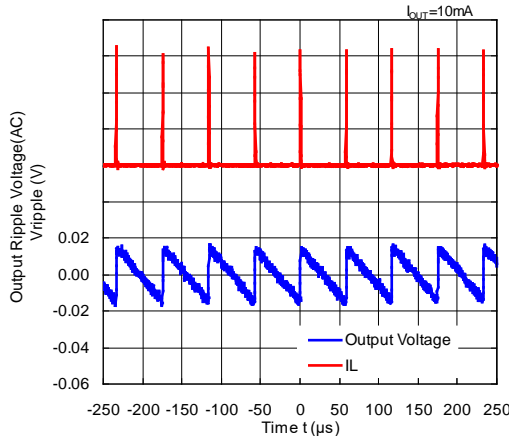

**RP506Kxx1D/E/F  $V_{OUT} = 1.8\text{ V}$  ( $V_{IN} = 3.6\text{ V}$ )  
MODE = "H" Forced PWM Control**

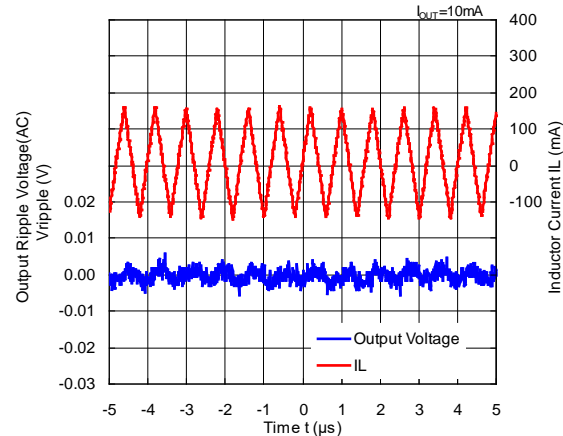

**RP506Kxx1D/E/F  $V_{OUT} = 3.3\text{ V}$  ( $V_{IN} = 5.0\text{ V}$ )  
MODE = "L" PWM/VFM Auto Switching Control**

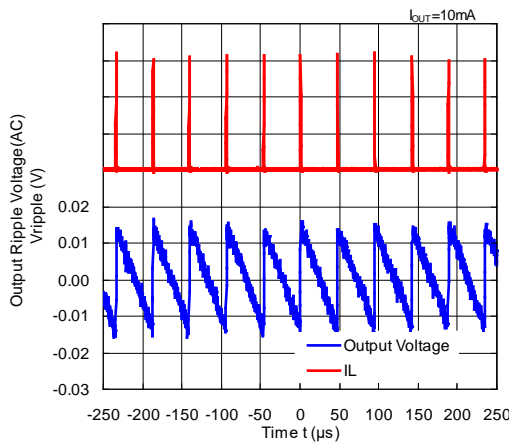

**RP506Kxx1D/E/F  $V_{OUT} = 3.3\text{ V}$  ( $V_{IN} = 5.0\text{ V}$ )  
MODE = "H" Forced PWM Control**

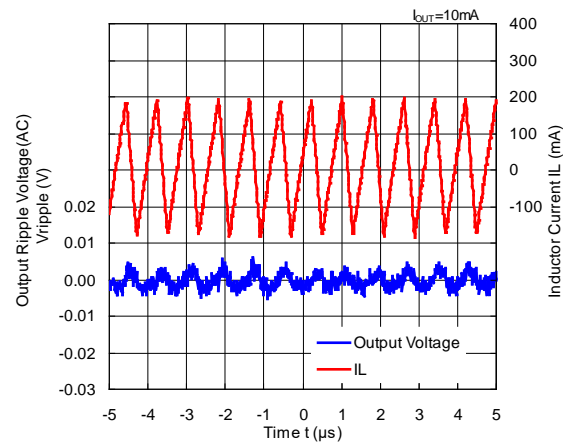

9) Oscillator Frequency vs. Ambient Temp.

RP506Kxx1A/B/C

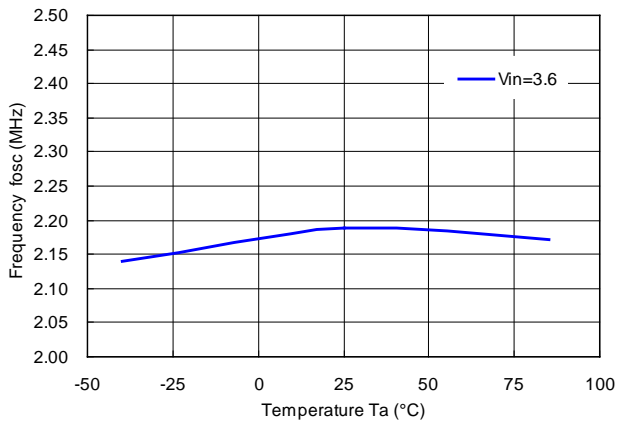

RP506Kxx1D/E/F

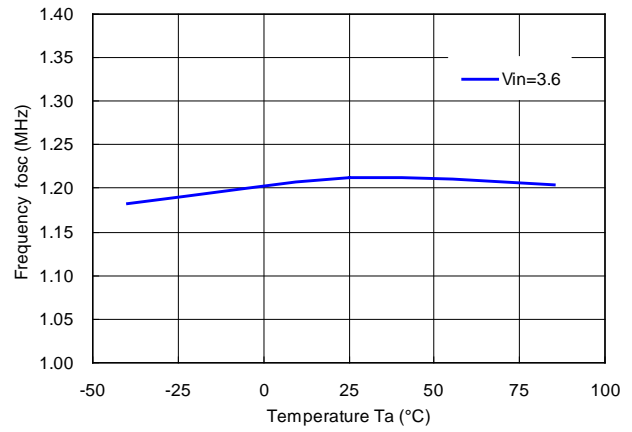

10) Oscillator Frequency vs. Input Voltage

RP506Kxx1A/B/C

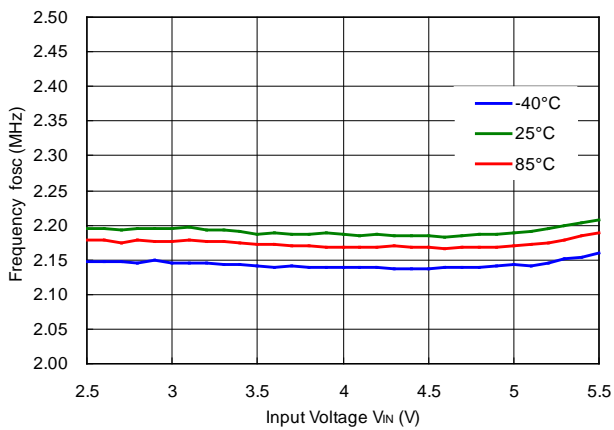

RP506Kxx1D/E/F

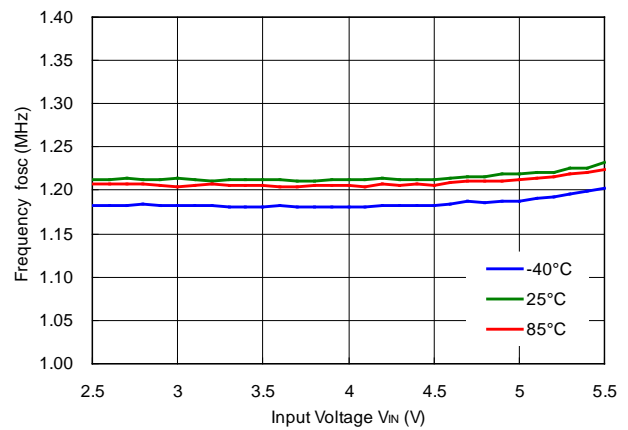

11) Soft-start Time vs. Ambient Temp.

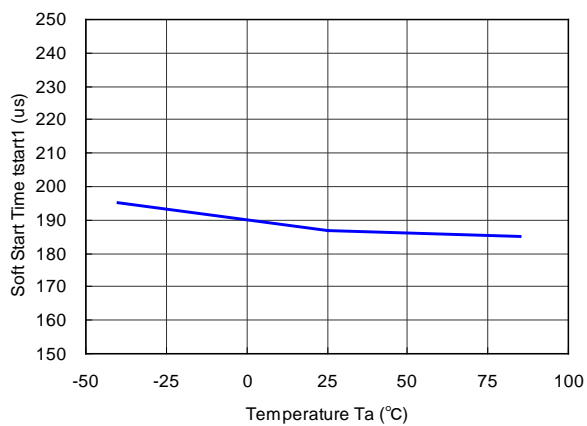

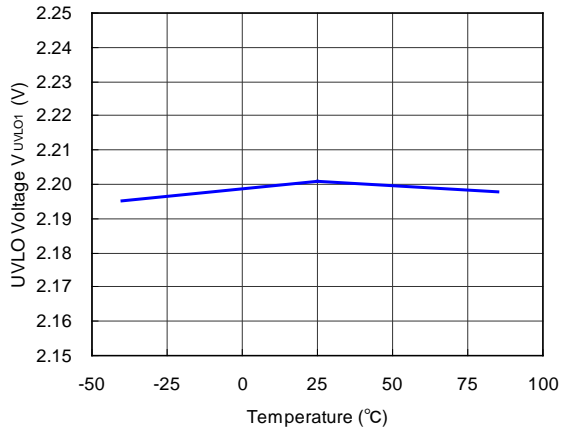
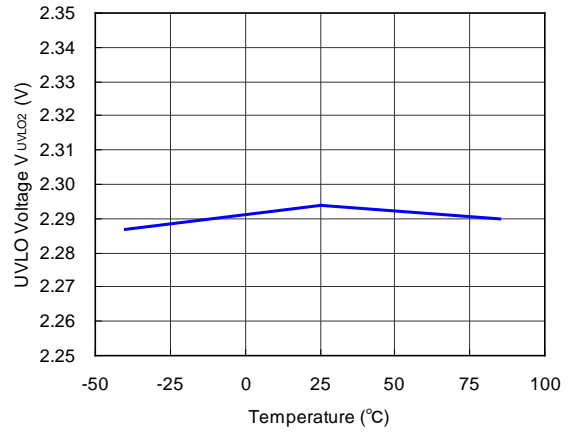
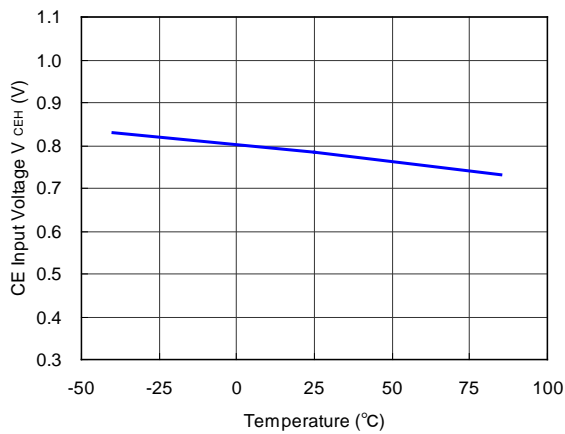
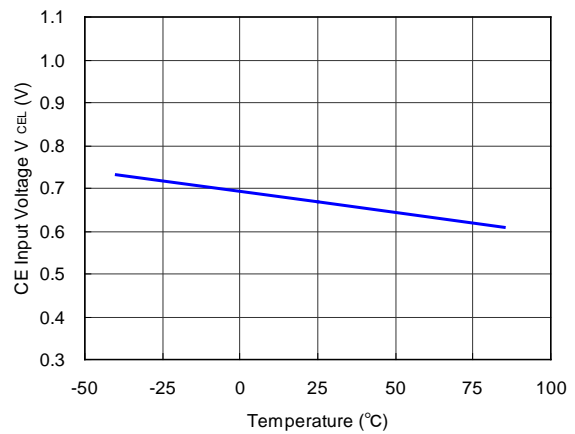
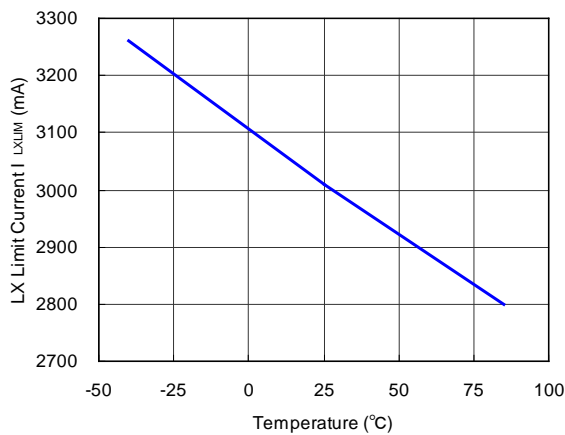
**12) UVLO Detector Threshold/ Released Voltage vs. Ambient Temp.****UVLO Detector Threshold****UVLO Released Voltage****13) CE Input Voltage vs. Ambient Temp.****CE“H” Input Voltage (V<sub>IN</sub> = 5.5 V)****CE“L” Input Voltage (V<sub>IN</sub> = 2.5 V)****14) Lx Limit Current vs. Ambient Temp.**

15) Nch Tr. ON Resistance vs. Ambient Temp.

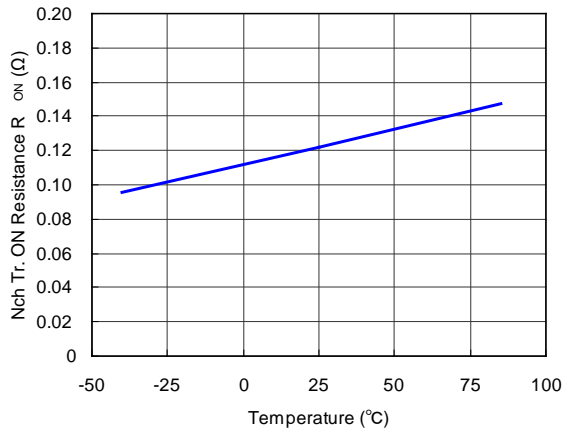

16) Pch Tr. ON Resistance vs. Ambient Temp.

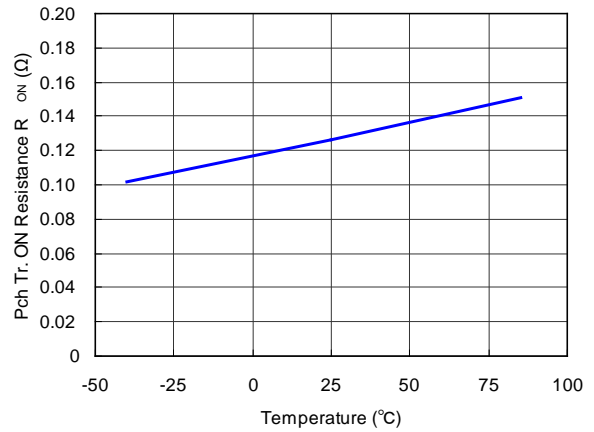

17) PG Detector Threshold vs. Ambient Temp.

Over Voltage Detection ( $V_{OVD}$ )

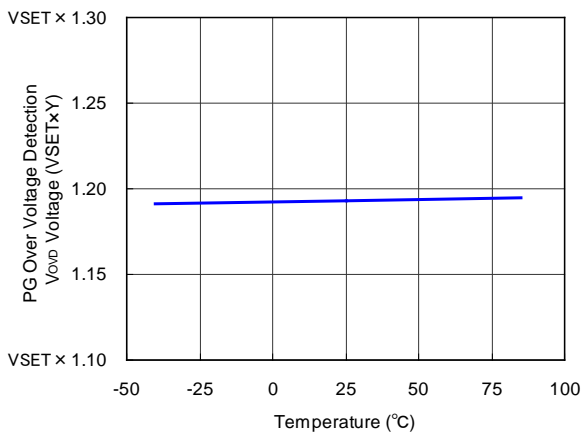

Under Voltage Detection ( $V_{UVD}$ )

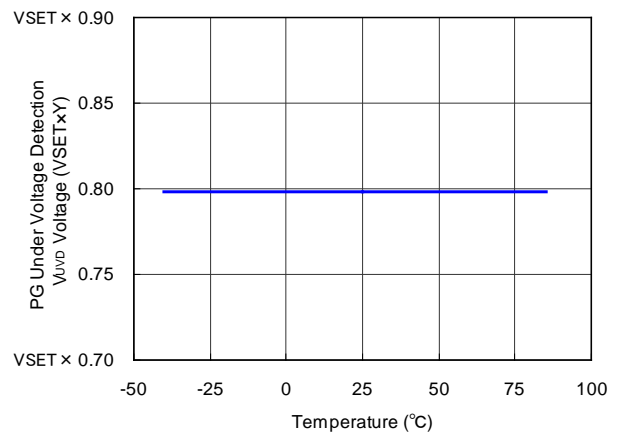

18) Soft-start Waveform

RP506K  $V_{OUT} = 1.8$  V TSS = Open

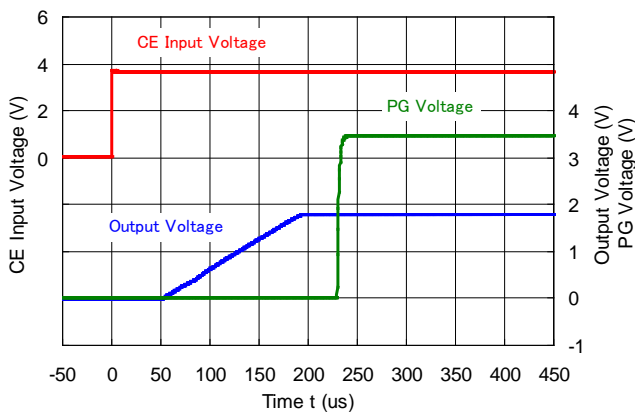

RP506K  $V_{OUT} = 1.8$  V TSS = 0.1 µF

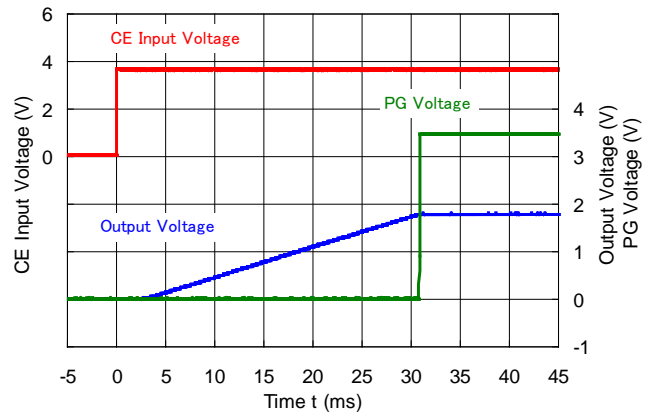

# RP506K

No.EA-296-210909

## 19) Load Transient Response

RP506Kxx1A/B/C ( $V_{IN} = 3.6\text{ V}$ ,  $V_{OUT} = 0.8\text{ V}$ )

MODE = "L" PWM/VFM Auto Switching Control

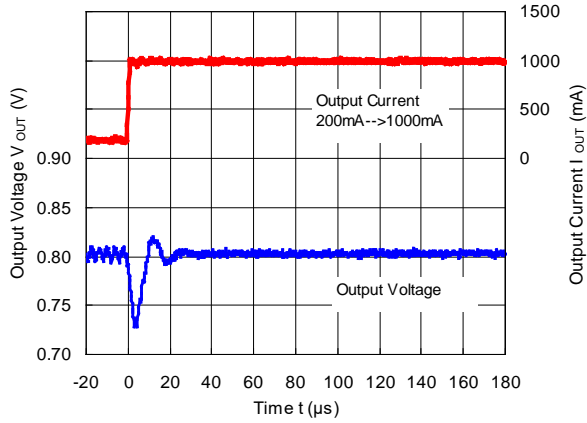

RP506Kxx1A/B/C ( $V_{IN} = 3.6\text{ V}$ ,  $V_{OUT} = 0.8\text{ V}$ )

MODE = "L" PWM/VFM Auto Switching Control

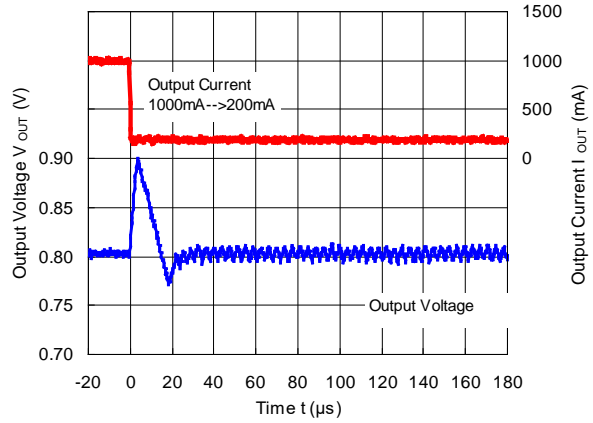

RP506Kxx1A/B/C ( $V_{IN} = 3.6\text{ V}$ ,  $V_{OUT} = 0.8\text{ V}$ )

MODE = "L" PWM/VFM Auto Switching Control

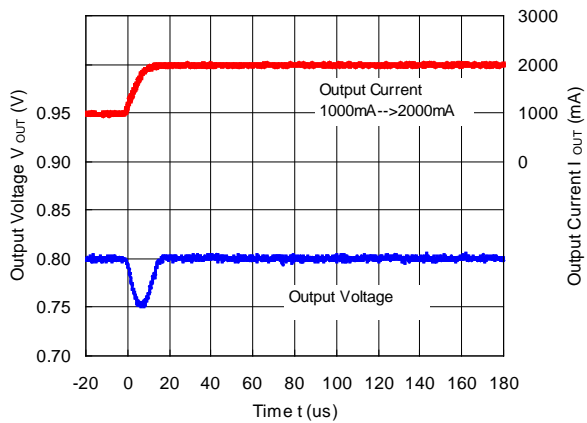

RP506Kxx1A/B/C ( $V_{IN} = 3.6\text{ V}$ ,  $V_{OUT} = 0.8\text{ V}$ )

MODE = "L" PWM/VFM Auto Switching Control

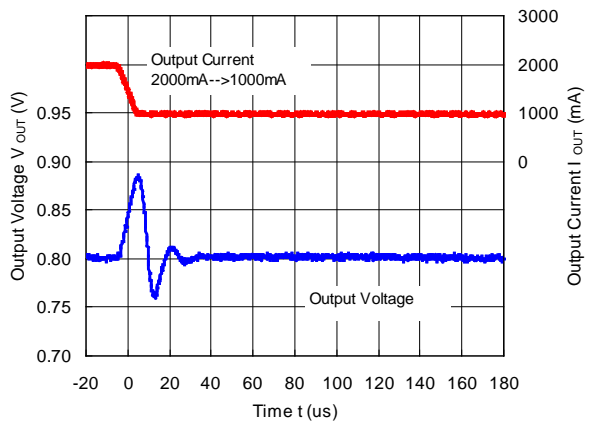

RP506Kxx1A/B/C ( $V_{IN} = 3.6\text{ V}$ ,  $V_{OUT} = 1.2\text{ V}$ )

MODE = "L" PWM/VFM Auto Switching Control

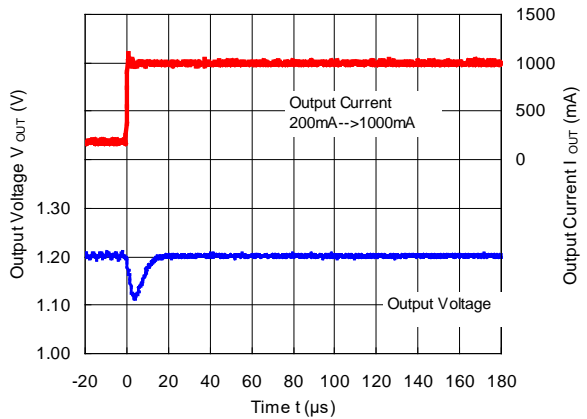

RP506Kxx1A/B/C ( $V_{IN} = 3.6\text{ V}$ ,  $V_{OUT} = 1.2\text{ V}$ )

MODE = "L" PWM/VFM Auto Switching Control

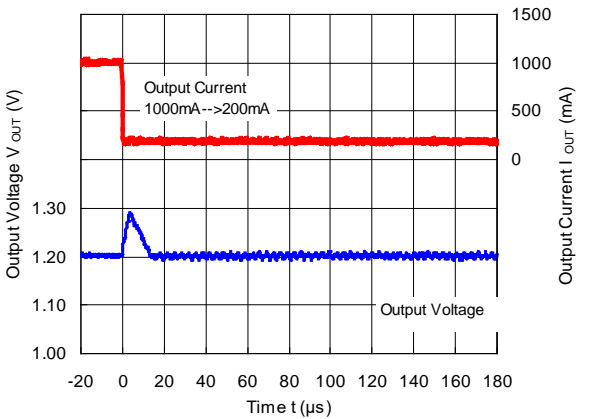



**RP506Kxx1A/B/C ( $V_{IN} = 3.6\text{ V}$ ,  $V_{OUT} = 1.2\text{ V}$ )  
MODE = "H" Forced PWM Control**

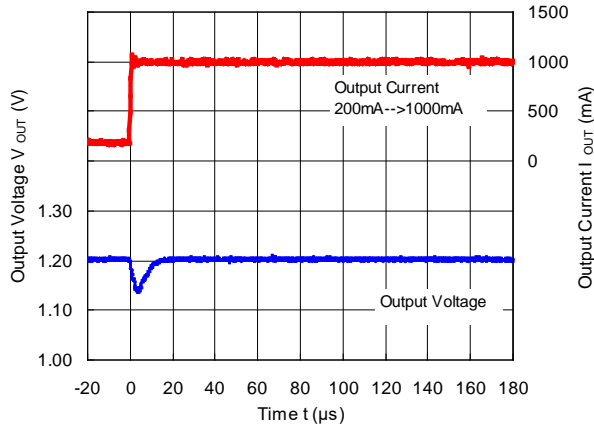

**RP506Kxx1A/B/C ( $V_{IN} = 3.6\text{ V}$ ,  $V_{OUT} = 1.2\text{ V}$ )  
MODE = "H" Forced PWM Control**

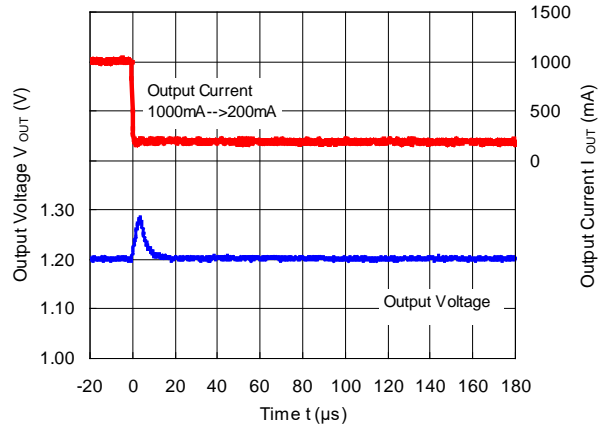

**RP506Kxx1A/B/C ( $V_{IN} = 3.6\text{ V}$ ,  $V_{OUT} = 1.2\text{ V}$ )**

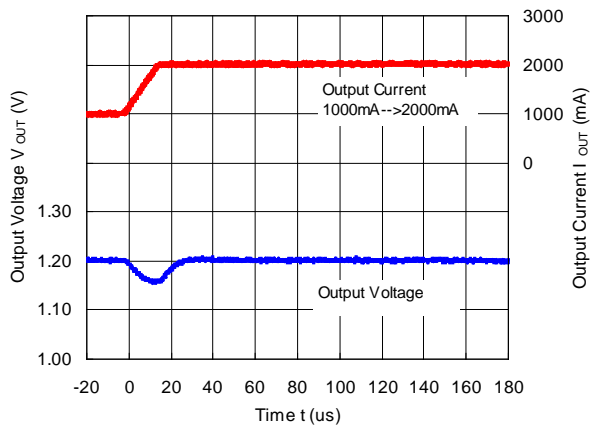

**RP506Kxx1A/B/C ( $V_{IN} = 3.6\text{ V}$ ,  $V_{OUT} = 1.2\text{ V}$ )**

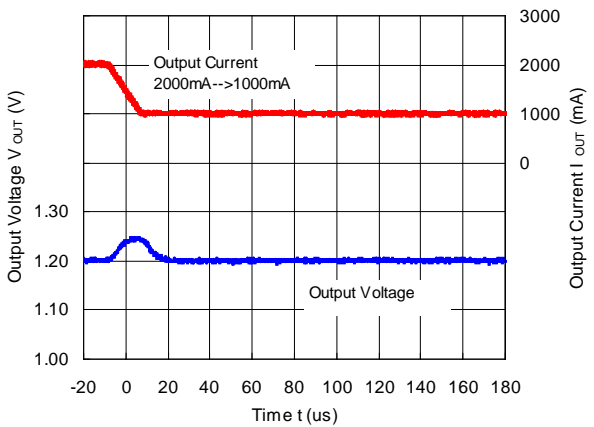

**RP506Kxx1A/B/C ( $V_{IN} = 3.6\text{ V}$ ,  $V_{OUT} = 1.8\text{ V}$ )  
MODE = "L" PWM/VFM Auto Switching Control**

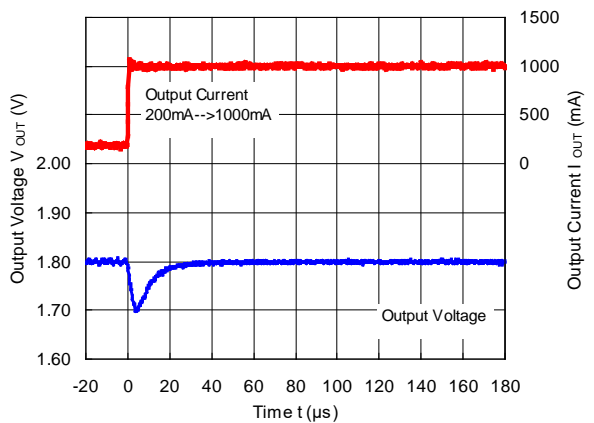

**RP506Kxx1A/B/C ( $V_{IN} = 3.6\text{ V}$ ,  $V_{OUT} = 1.8\text{ V}$ )  
MODE = "L" PWM/VFM Auto Switching Control**

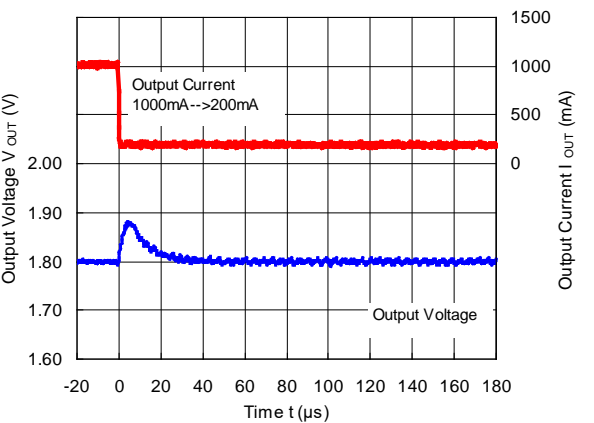

# RP506K

No.EA-296-210909

**RP506Kxx1A/B/C ( $V_{IN} = 3.6\text{ V}$ ,  $V_{OUT} = 1.8\text{ V}$ )**  
**MODE = "H" Forced PWM Control**

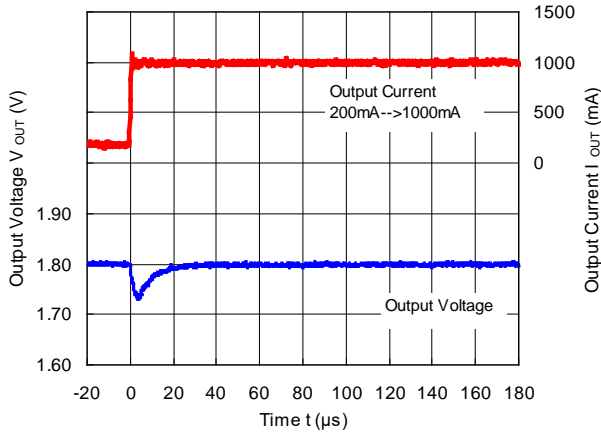

**RP506Kxx1A/B/C ( $V_{IN} = 3.6\text{ V}$ ,  $V_{OUT} = 1.8\text{ V}$ )**  
**MODE = "H" Forced PWM Control**

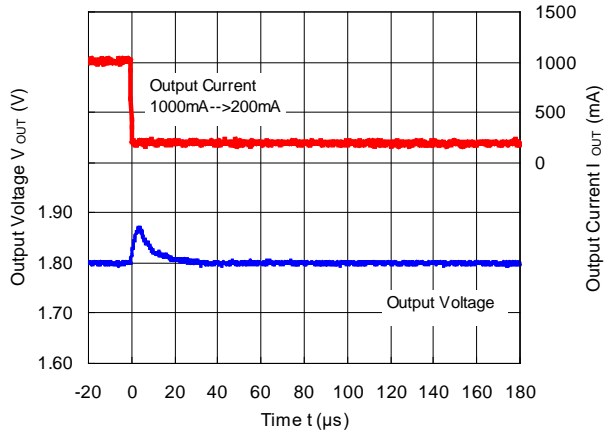

**RP506Kxx1A/B/C ( $V_{IN} = 3.6\text{ V}$ ,  $V_{OUT} = 1.8\text{ V}$ )**

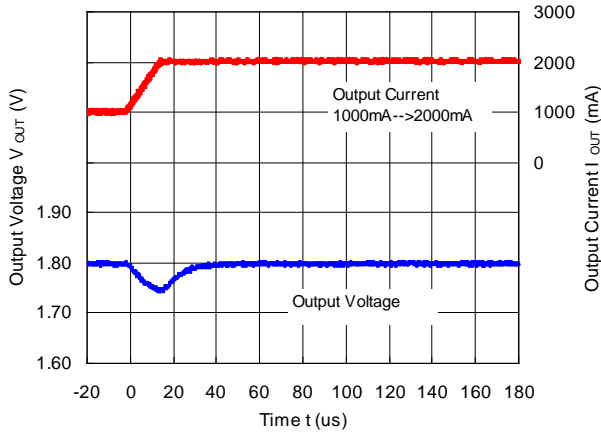

**RP506Kxx1A/B/C ( $V_{IN} = 3.6\text{ V}$ ,  $V_{OUT} = 1.8\text{ V}$ )**

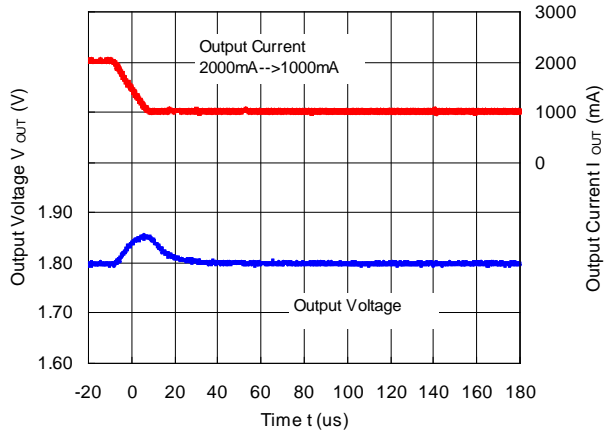

**RP506Kxx1A/B/C ( $V_{IN} = 5.0\text{ V}$ ,  $V_{OUT} = 3.3\text{ V}$ )**

**MODE = "L" PWM/VFM Auto Switching Control**

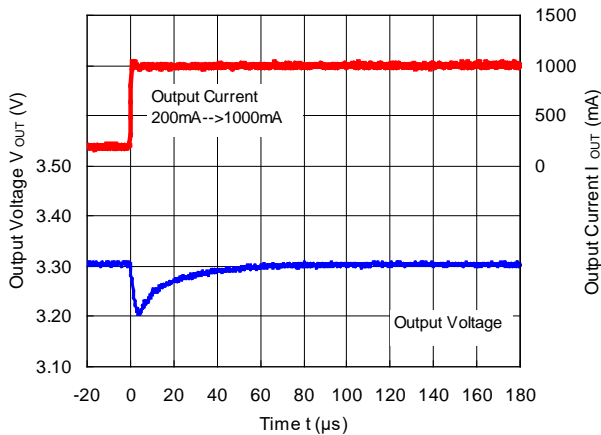

**RP506Kxx1A/B/C ( $V_{IN} = 5.0\text{ V}$ ,  $V_{OUT} = 3.3\text{ V}$ )**

**MODE = "L" PWM/VFM Auto Switching Control**

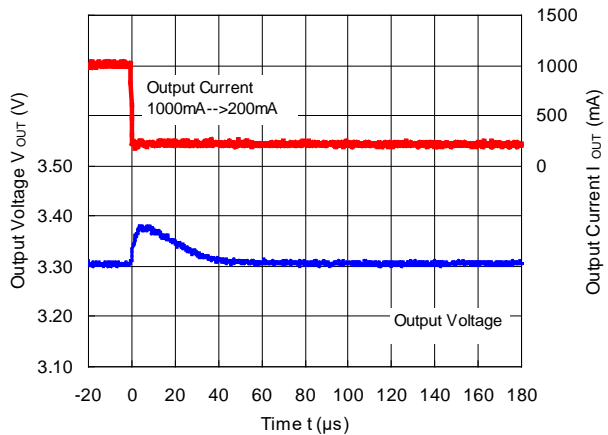

RP506Kxx1A/B/C ( $V_{IN} = 5.0\text{ V}$ ,  $V_{OUT} = 3.3\text{ V}$ )

MODE = "H" Forced PWM Control

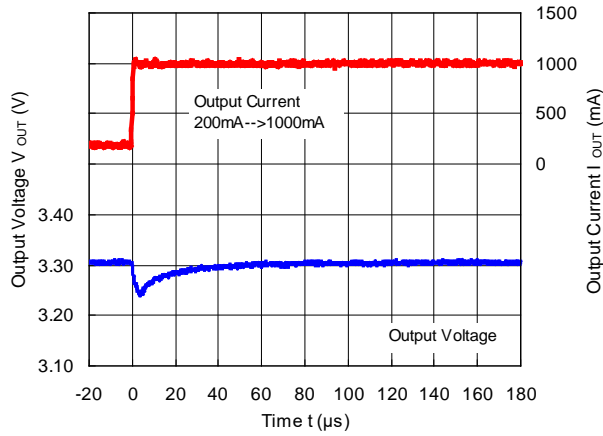

RP506Kxx1A/B/C ( $V_{IN} = 5.0\text{ V}$ ,  $V_{OUT} = 3.3\text{ V}$ )

MODE = "H" Forced PWM Control

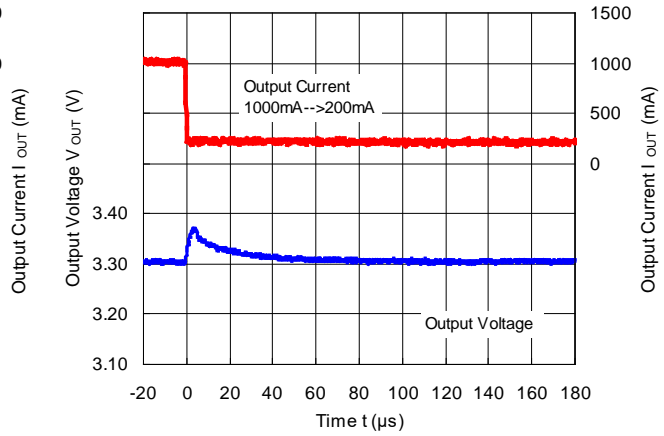

RP506Kxx1A/B/C ( $V_{IN} = 5.0\text{ V}$ ,  $V_{OUT} = 3.3\text{ V}$ )

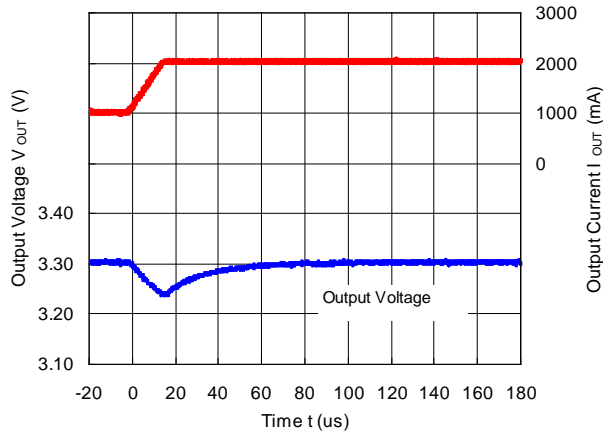

RP506Kxx1A/B/C ( $V_{IN} = 5.0\text{ V}$ ,  $V_{OUT} = 3.3\text{ V}$ )

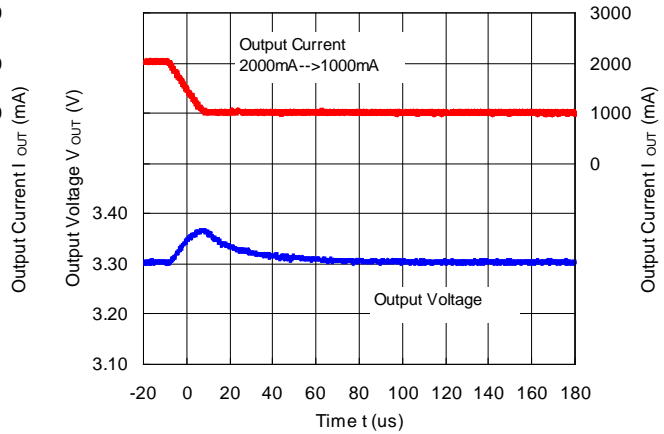

RP506Kxx1D/E/F ( $V_{IN} = 3.6\text{ V}$ ,  $V_{OUT} = 0.6\text{ V}$ )

MODE = "L" PWM/VFM Auto Switching Control

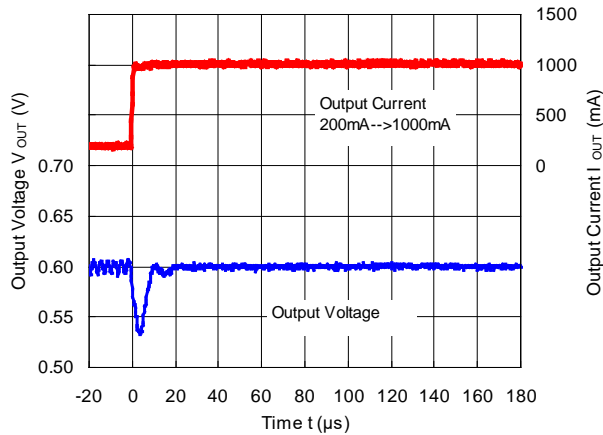

RP506Kxx1D/E/F ( $V_{IN} = 3.6\text{ V}$ ,  $V_{OUT} = 0.6\text{ V}$ )

MODE = "L" PWM/VFM Auto Switching Control

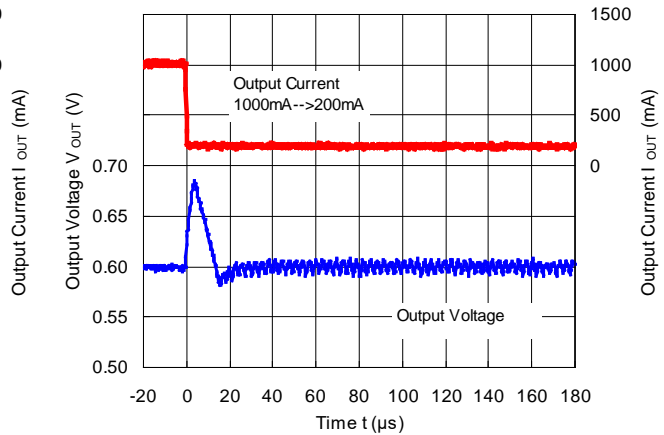

# RP506K

No.EA-296-210909

RP506Kxx1D/E/F ( $V_{IN} = 3.6\text{ V}$ ,  $V_{OUT} = 0.6\text{ V}$ )

MODE = "H" Forced PWM Control

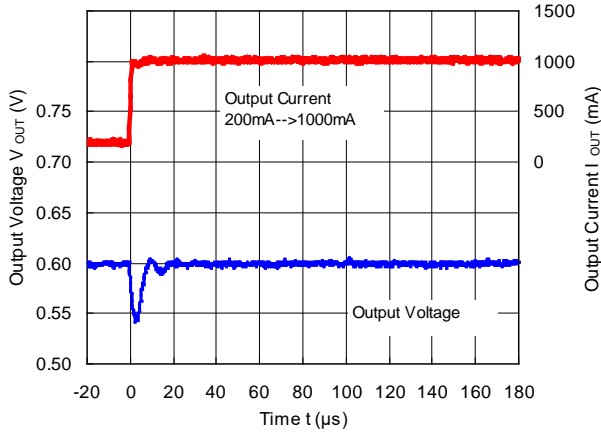

RP506Kxx1D/E/F ( $V_{IN} = 3.6\text{ V}$ ,  $V_{OUT} = 0.6\text{ V}$ )

MODE = "H" Forced PWM Control

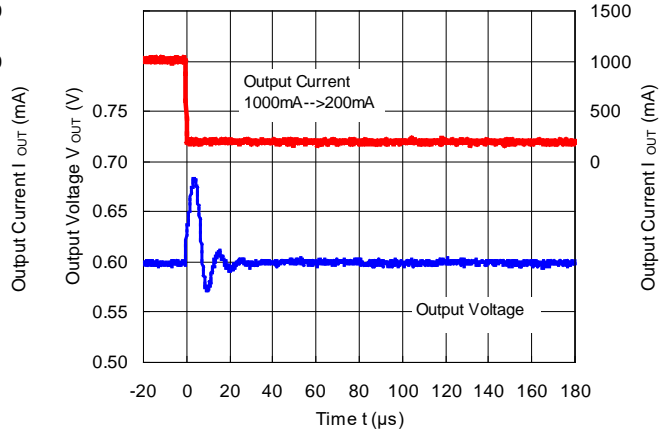

RP506Kxx1D/E/F ( $V_{IN} = 3.6\text{ V}$ ,  $V_{OUT} = 0.6\text{ V}$ )

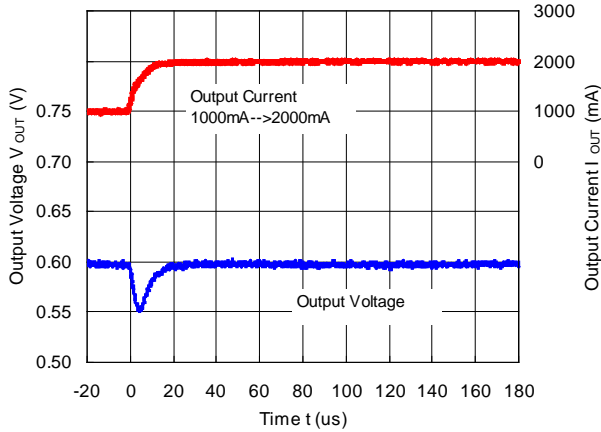

RP506Kxx1D/E/F ( $V_{IN} = 3.6\text{ V}$ ,  $V_{OUT} = 0.6\text{ V}$ )

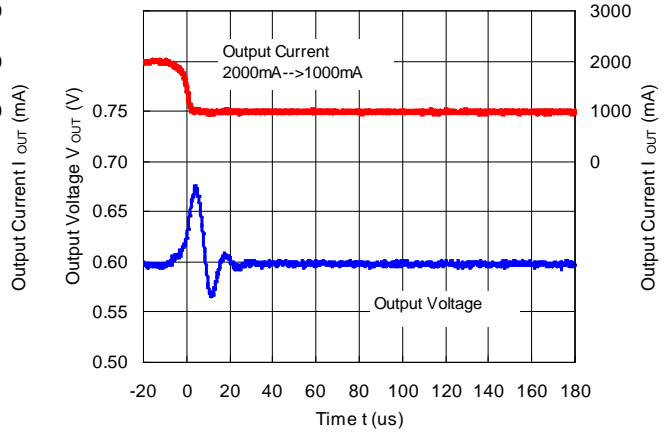

RP506Kxx1D/E/F ( $V_{IN} = 3.6\text{ V}$ ,  $V_{OUT} = 0.8\text{ V}$ )

MODE = "L" PWM/VFM Auto Switching Control

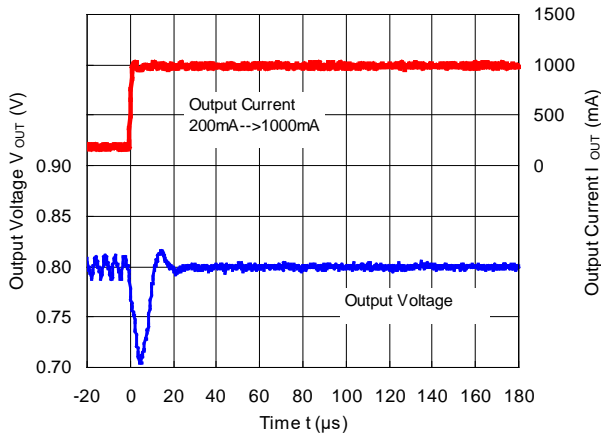

RP506Kxx1D/E/F ( $V_{IN} = 3.6\text{ V}$ ,  $V_{OUT} = 0.8\text{ V}$ )

MODE = "L" PWM/VFM Auto Switching Control

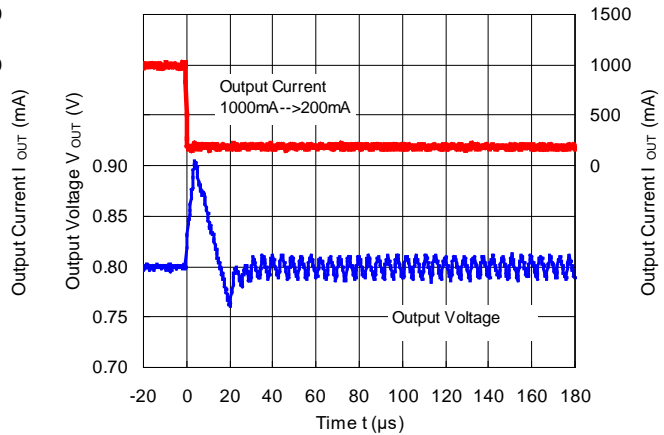

RP506Kxx1D/E/F ( $V_{IN} = 3.6\text{ V}$ ,  $V_{OUT} = 0.8\text{ V}$ )

MODE = "H" Forced PWM Control

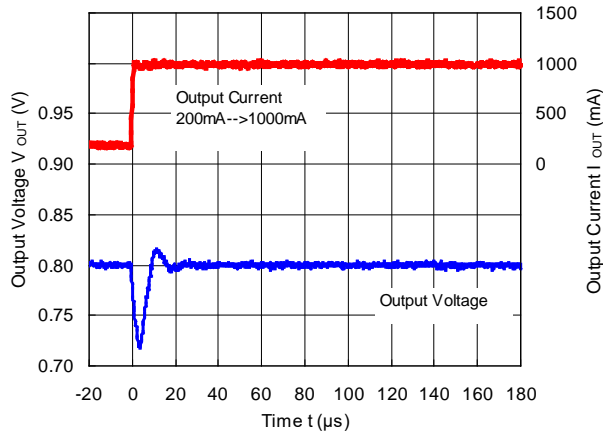

RP506Kxx1D/E/F ( $V_{IN} = 3.6\text{ V}$ ,  $V_{OUT} = 0.8\text{ V}$ )

MODE = "H" Forced PWM Control

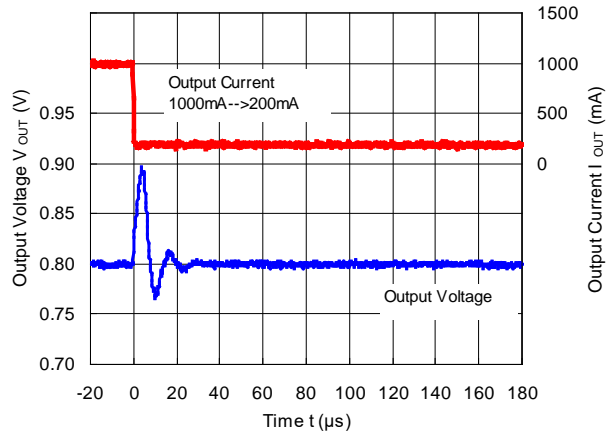

RP506Kxx1D/E/F ( $V_{IN} = 3.6\text{ V}$ ,  $V_{OUT} = 0.8\text{ V}$ )

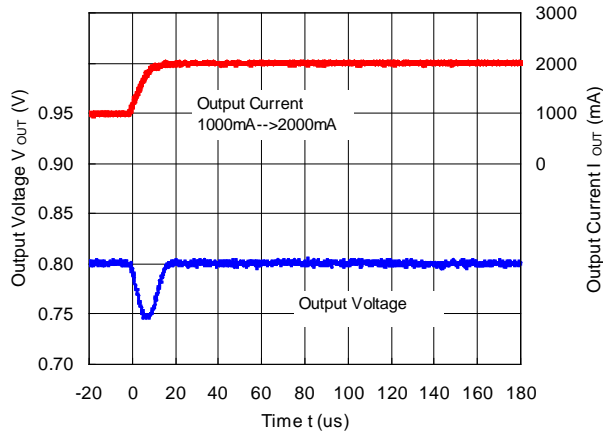

RP506Kxx1D/E/F ( $V_{IN} = 3.6\text{ V}$ ,  $V_{OUT} = 0.8\text{ V}$ )

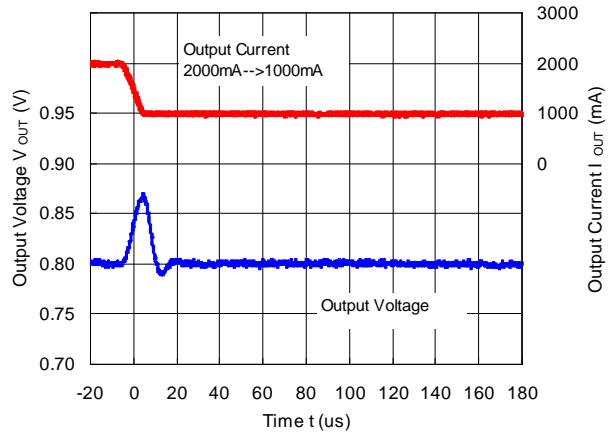

RP506Kxx1D/E/F ( $V_{IN} = 3.6\text{ V}$ ,  $V_{OUT} = 1.2\text{ V}$ )

MODE = "L" PWM/VFM Auto Switching Control

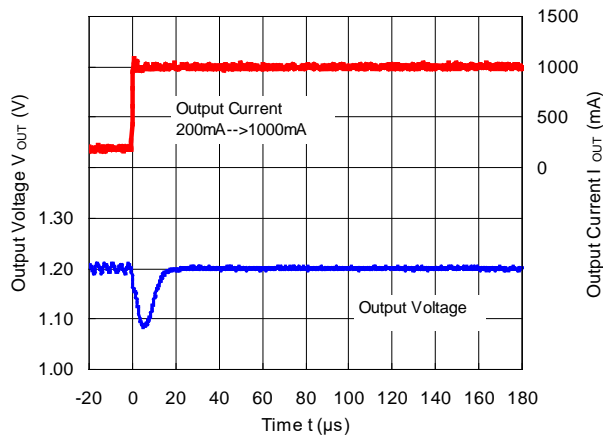

RP506Kxx1D/E/F ( $V_{IN} = 3.6\text{ V}$ ,  $V_{OUT} = 1.2\text{ V}$ )

MODE = "L" PWM/VFM Auto Switching Control

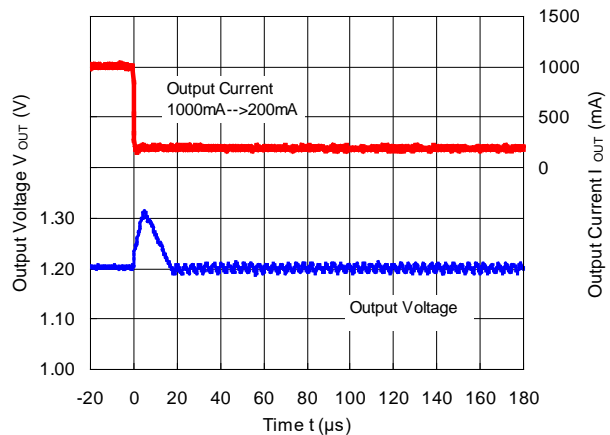

# RP506K

No.EA-296-210909

RP506Kxx1D/E/F ( $V_{IN} = 3.6\text{ V}$ ,  $V_{OUT} = 1.2\text{ V}$ )

MODE = "H" Forced PWM Control

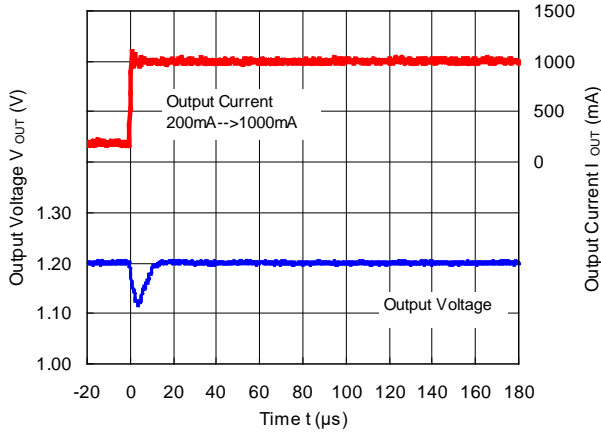

RP506Kxx1D/E/F ( $V_{IN} = 3.6\text{ V}$ ,  $V_{OUT} = 1.2\text{ V}$ )

MODE = "H" Forced PWM Control

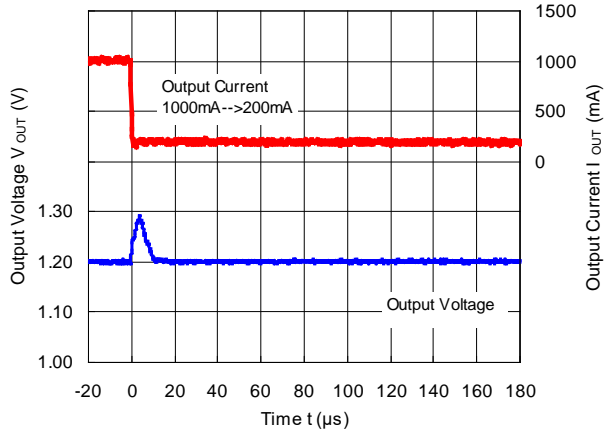

RP506Kxx1D/E/F ( $V_{IN} = 3.6\text{ V}$ ,  $V_{OUT} = 1.2\text{ V}$ )

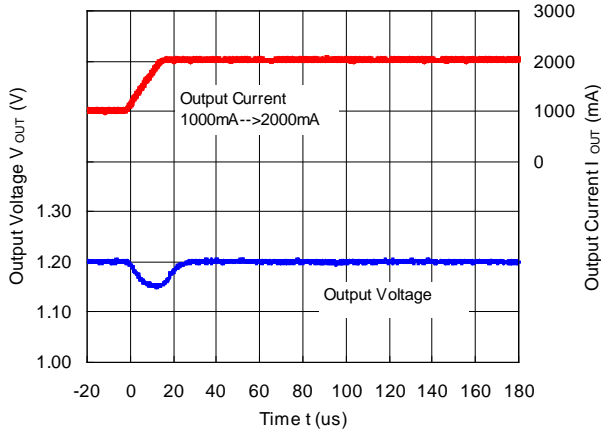

RP506Kxx1D/E/F ( $V_{IN} = 3.6\text{ V}$ ,  $V_{OUT} = 1.2\text{ V}$ )

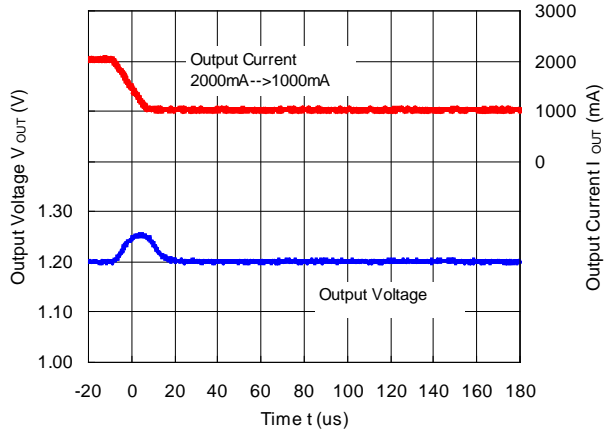

RP506Kxx1D/E/F ( $V_{IN} = 3.6\text{ V}$ ,  $V_{OUT} = 1.8\text{ V}$ )

MODE = "L" PWM/VFM Auto Switching Control

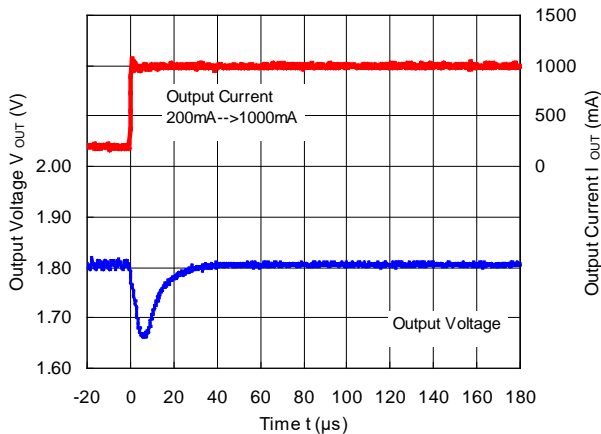

RP506Kxx1D/E/F ( $V_{IN} = 3.6\text{ V}$ ,  $V_{OUT} = 1.8\text{ V}$ )

MODE = "L" PWM/VFM Auto Switching Control

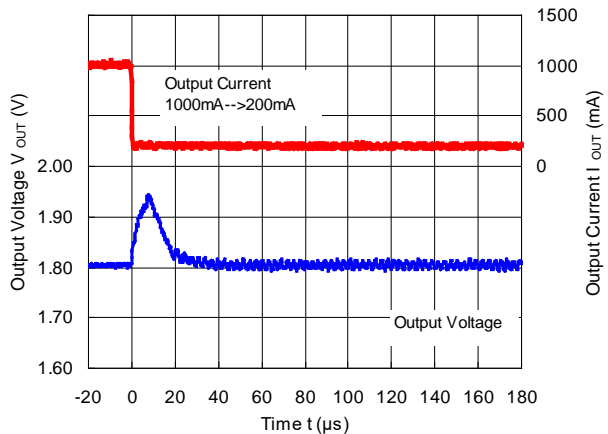

RP506Kxx1D/E/F ( $V_{IN} = 3.6\text{ V}$ ,  $V_{OUT} = 1.8\text{ V}$ )

MODE = "H" Forced PWM Control

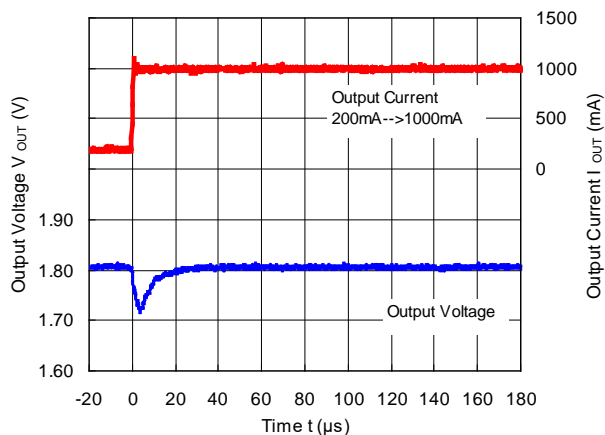

RP506Kxx1D/E/F ( $V_{IN} = 3.6\text{ V}$ ,  $V_{OUT} = 1.8\text{ V}$ )

MODE = "H" Forced PWM Control

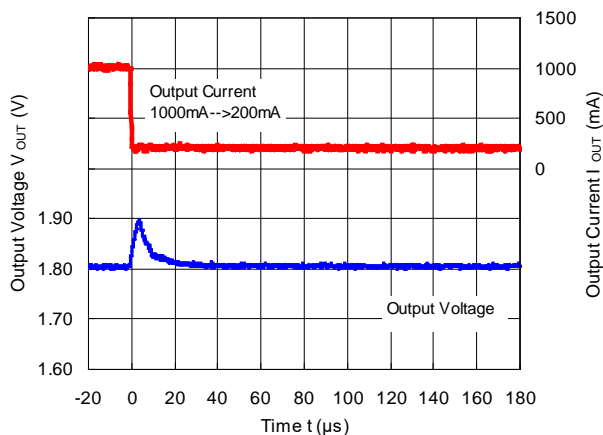

RP506Kxx1D/E/F ( $V_{IN} = 3.6\text{ V}$ ,  $V_{OUT} = 1.8\text{ V}$ )

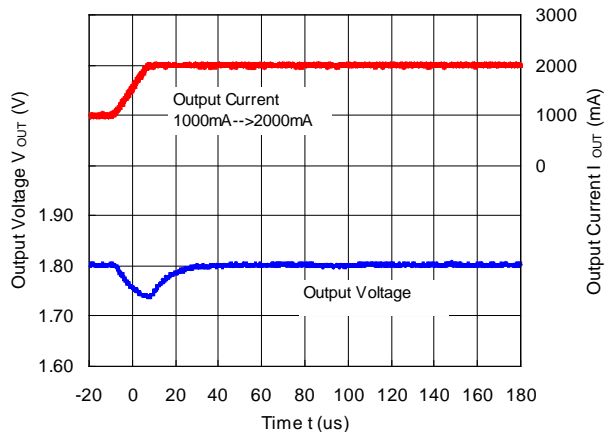

RP506Kxx1D/E/F ( $V_{IN} = 3.6\text{ V}$ ,  $V_{OUT} = 1.8\text{ V}$ )

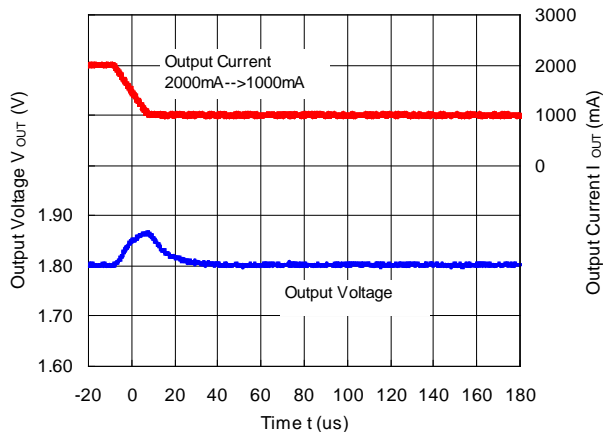

RP506Kxx1D/E/F ( $V_{IN} = 5.0\text{ V}$ ,  $V_{OUT} = 3.3\text{ V}$ )

MODE = "L" PWM/VFM Auto Switching Control

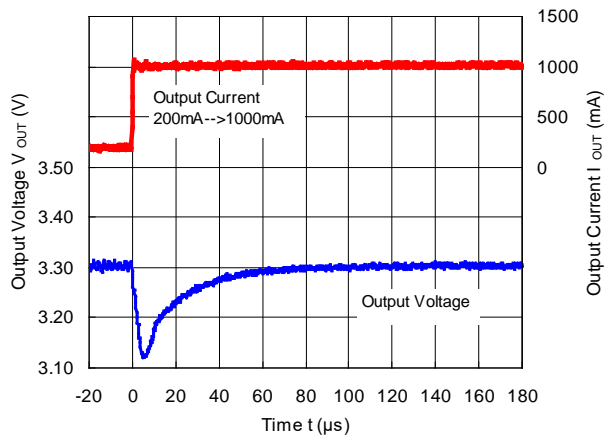

RP506Kxx1D/E/F ( $V_{IN} = 5.0\text{ V}$ ,  $V_{OUT} = 3.3\text{ V}$ )

MODE = "L" PWM/VFM Auto Switching Control

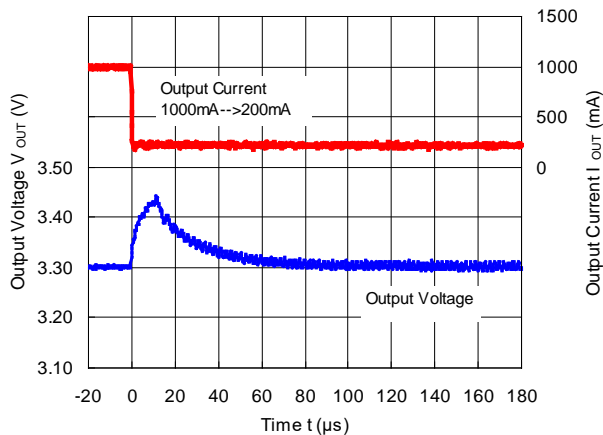

# RP506K

No.EA-296-210909

**RP506Kxx1D/E/F ( $V_{IN} = 5.0\text{ V}$ ,  $V_{OUT} = 3.3\text{ V}$ )**

**MODE = "H" Forced PWM Control**

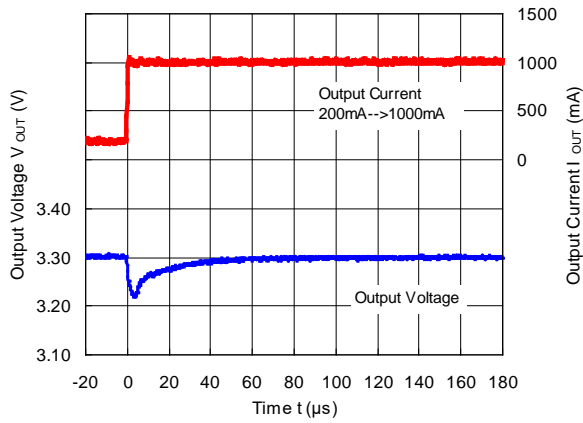

**RP506Kxx1D/E/F ( $V_{IN} = 5.0\text{ V}$ ,  $V_{OUT} = 3.3\text{ V}$ )**

**MODE = "H" Forced PWM Control**

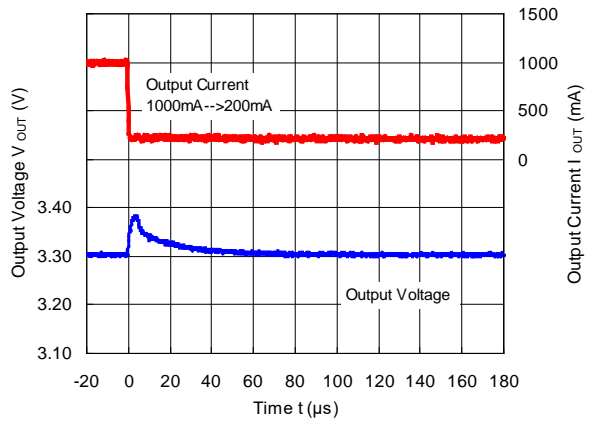

**RP506Kxx1D/E/F ( $V_{IN} = 5.0\text{ V}$ ,  $V_{OUT} = 3.3\text{ V}$ )**

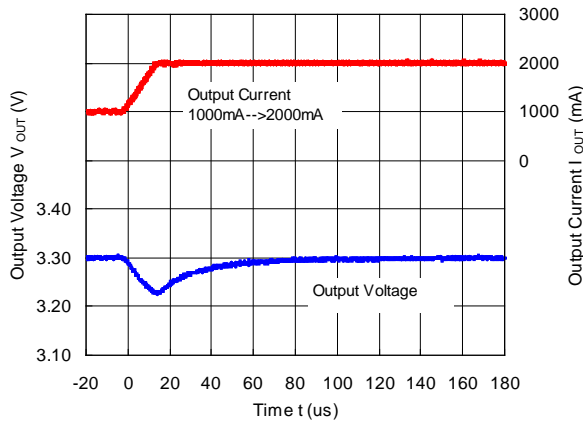

**RP506Kxx1D/E/F ( $V_{IN} = 5.0\text{ V}$ ,  $V_{OUT} = 3.3\text{ V}$ )**

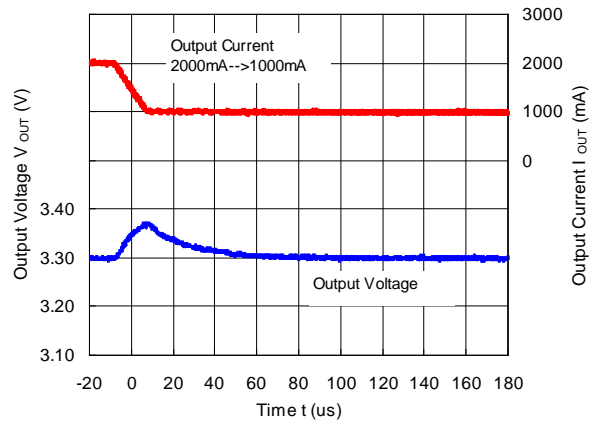

## 20) Auto Switching Control Waveform

**RP506Kxx1A/B/C**

**( $V_{IN} = 3.6\text{ V}$ ,  $V_{OUT} = 1.2\text{ V}$ ,  $I_{OUT} = 1\text{ mA}$ )**

**MODE = "L" --> MODE = "H"**

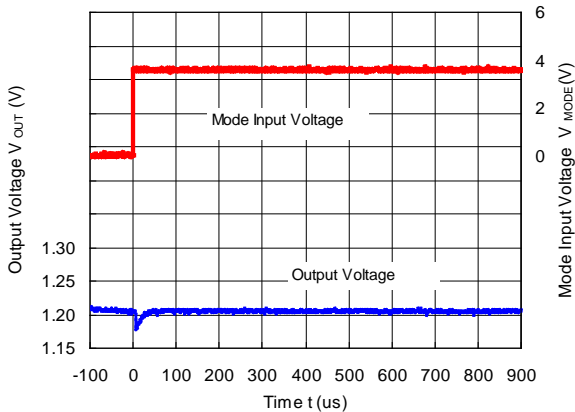

**RP506Kxx1A/B/C**

**( $V_{IN} = 3.6\text{ V}$ ,  $V_{OUT} = 1.2\text{ V}$ ,  $I_{OUT} = 1\text{ mA}$ )**

**MODE = "H" --> MODE = "L"**

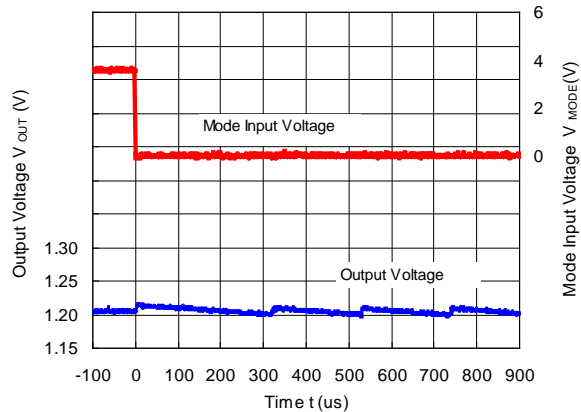



**RP506Kxx1A/B/C**  
 (V<sub>IN</sub> = 3.6 V, V<sub>OUT</sub> = 1.8 V, I<sub>OUT</sub> = 1 mA)  
 MODE = "L" --> MODE = "H"

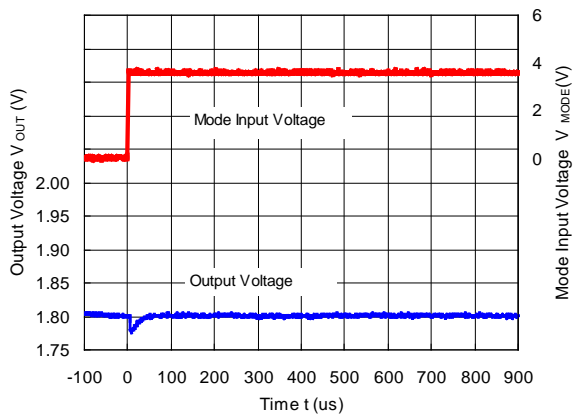

**RP506Kxx1A/B/C**  
 (V<sub>IN</sub> = 3.6 V, V<sub>OUT</sub> = 1.8 V, I<sub>OUT</sub> = 1 mA)  
 MODE = "H" --> MODE = "L"

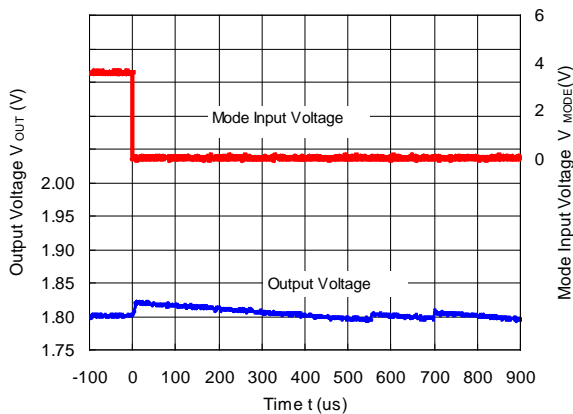

**RP506Kxx1D/E/F**  
 (V<sub>IN</sub> = 3.6 V, V<sub>OUT</sub> = 1.2 V, I<sub>OUT</sub> = 1 mA)  
 MODE = "L" --> MODE = "H"

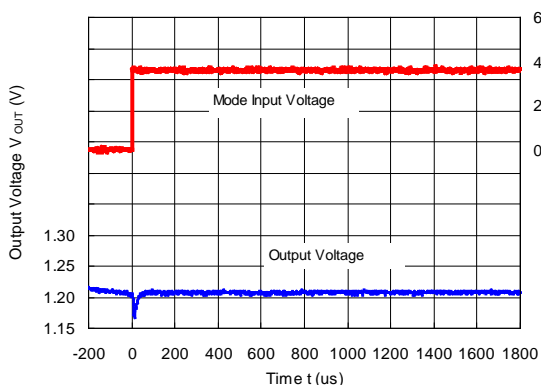

**RP506Kxx1D/E/F**  
 (V<sub>IN</sub> = 3.6 V, V<sub>OUT</sub> = 1.2 V, I<sub>OUT</sub> = 1 mA)  
 MODE = "H" --> MODE = "L"

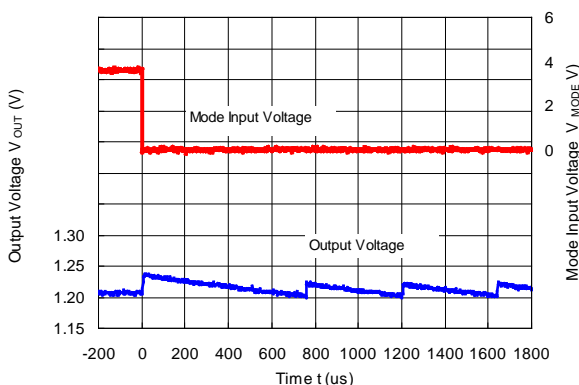

**RP506Kxx1D/E/F**  
 (V<sub>IN</sub> = 3.6 V, V<sub>OUT</sub> = 1.8 V, I<sub>OUT</sub> = 1 mA)  
 MODE = "L" --> MODE = "H"

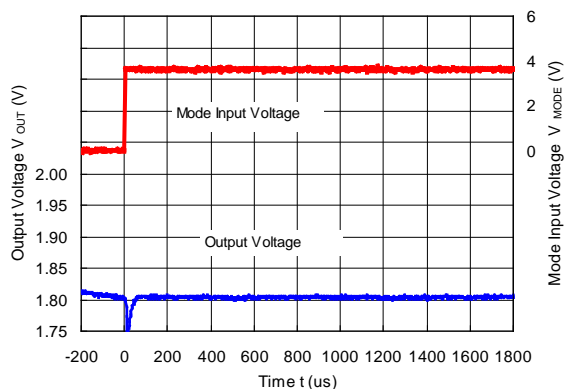

**RP506Kxx1D/E/F**  
 (V<sub>IN</sub> = 3.6 V, V<sub>OUT</sub> = 1.8 V, I<sub>OUT</sub> = 1 mA)  
 MODE = "H" --> MODE = "L"

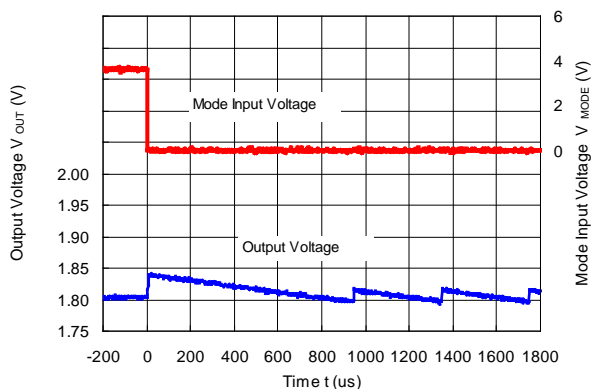

The power dissipation of the package is dependent on PCB material, layout, and environmental conditions. The following conditions are used in this measurement.

**Measurement Conditions**

	<b>High Wattage Land Pattern</b>	<b>Standard Land Pattern</b>
Environment	Mounting on Board (Wind Velocity = 0 m/s)	Mounting on Board (Wind Velocity = 0 m/s)
Board Material	Glass Cloth Epoxy Plastic (Four-Layer Board)	Glass Cloth Epoxy Plastic (Double-Sided Board)
Board Dimensions	35 mm × 90 mm × 0.8 mm	40 mm × 40 mm × 1.6 mm
Copper Ratio	Outer Layers (First and Fourth Layers): Approx. 15% Inner Layers (Second and Third Layers): Approx. 15%	Top Side: Approx. 50% Bottom Side: Approx. 50%
Copper Foil Thickness	Outer Layers (First and Fourth Layers): Approx. 35 μm Inner Layers (Second and Third Layers): Approx. 18 μm	Top Side: Approx. 35 μm Bottom Side: Approx. 35 μm
Through-holes	φ 0.3 mm × 9 holes (connecting outer and inner layers to a package tab) φ 0.5 mm × 10 holes (connecting pins)	φ 0.54 mm × 30 holes

**Measurement Result**

(Ta = 25°C, Tjmax = 125°C)

	<b>High Wattage Land Pattern</b>	<b>Standard Land Pattern</b>
Power Dissipation	1400 mW (Tjmax = 125°C)	910 mW (Tjmax = 125°C)
Thermal Resistance	$\theta_{ja} = (125 - 25^\circ\text{C}) / 1.4 \text{ W} = 71^\circ\text{C/W}$	$\theta_{jc} = (125 - 25^\circ\text{C}) / 0.91 \text{ W} = 110^\circ\text{C/W}$

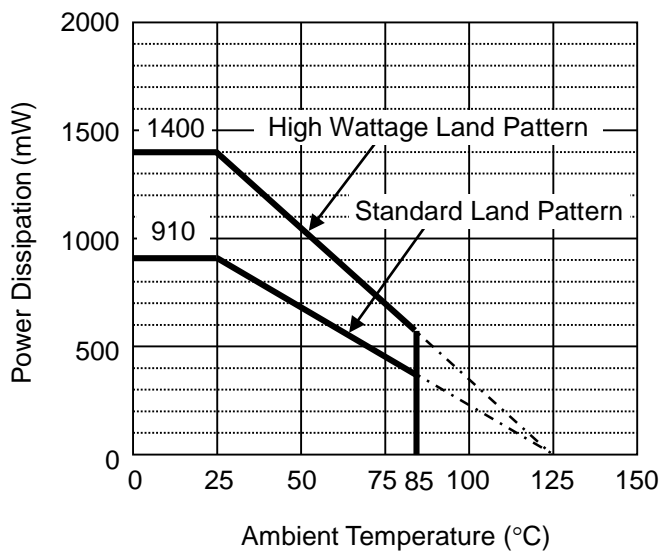

**Power Dissipation vs. Ambient Temperature**

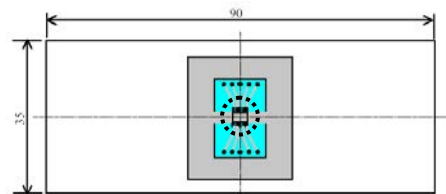

**High Wattage**

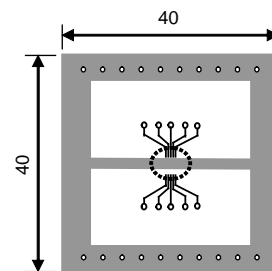

**Standard**

○ IC Mount Area (mm)

**Measurement Board Pattern**

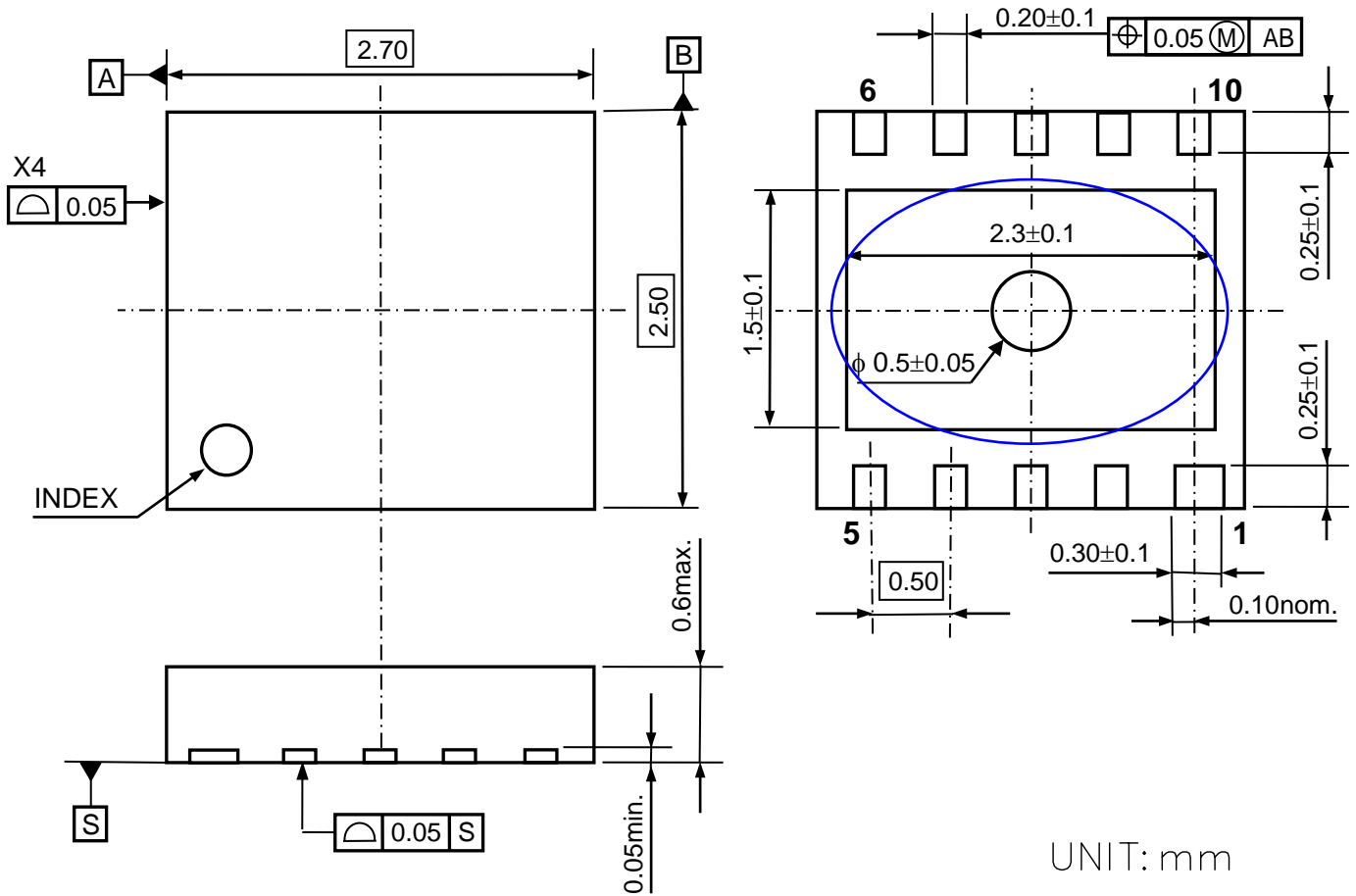

**DFN(PLP)2527-10 Package Dimensions**

\* The tab on the bottom of the package is substrate level (GND). It is recommended that the tab be connected to the ground plane on the board, or otherwise be left floating.



1. The products and the product specifications described in this document are subject to change or discontinuation of production without notice for reasons such as improvement. Therefore, before deciding to use the products, please refer to our sales representatives for the latest information thereon.
2. The materials in this document may not be copied or otherwise reproduced in whole or in part without prior written consent of our company.
3. Please be sure to take any necessary formalities under relevant laws or regulations before exporting or otherwise taking out of your country the products or the technical information described herein.
4. The technical information described in this document shows typical characteristics of and example application circuits for the products. The release of such information is not to be construed as a warranty of or a grant of license under our company's or any third party's intellectual property rights or any other rights.
5. The products listed in this document are intended and designed for use as general electronic components in standard applications (office equipment, telecommunication equipment, measuring instruments, consumer electronic products, amusement equipment etc.). Those customers intending to use a product in an application requiring extreme quality and reliability, for example, in a highly specific application where the failure or misoperation of the product could result in human injury or death (aircraft, spacevehicle, nuclear reactor control system, traffic control system, automotive and transportation equipment, combustion equipment, safety devices, life support system etc.) should first contact us.
6. We are making our continuous effort to improve the quality and reliability of our products, but semiconductor products are likely to fail with certain probability. In order to prevent any injury to persons or damages to property resulting from such failure, customers should be careful enough to incorporate safety measures in their design, such as redundancy feature, fire containment feature and fail-safe feature. We do not assume any liability or responsibility for any loss or damage arising from misuse or inappropriate use of the products.
7. Anti-radiation design is not implemented in the products described in this document.
8. The X-ray exposure can influence functions and characteristics of the products. Confirm the product functions and characteristics in the evaluation stage.
9. WLCSP products should be used in light shielded environments. The light exposure can influence functions and characteristics of the products under operation or storage.
10. There can be variation in the marking when different AOI (Automated Optical Inspection) equipment is used. In the case of recognizing the marking characteristic with AOI, please contact our sales or our distributor before attempting to use AOI.
11. Please contact our sales representatives should you have any questions or comments concerning the products or the technical information.



**Nisshinbo Micro Devices Inc.**

**Official website**

<https://www.nisshinbo-microdevices.co.jp/en/>

**Purchase information**

<https://www.nisshinbo-microdevices.co.jp/en/buy/>

