

ADJUSTABLE HIGH PRECISION SHUNT REGULATOR

■GENERAL DESCRIPTION

The **NJM2373/NJM2373A** and **NJM2376** are adjustable high precision shunt regulators.

The output voltage can be adjusted to any value between reference voltage and 14V by two extend resistors.

■PACKAGE OUTLINE



NJM2373F/AF
NJM2376F

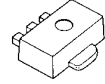

NJM2373U/AU
NJM2376U

■FEATURES

- Operating Voltage V_{REF} to 13V
- High Precision Voltage Reference

NJM2373	1.25V±2%
NJM2373A/76	1.25V±1%
- Minimum Input Current 80uA typ.
- Adjustable Output Voltage For
External Resistance two Parts
- Bipolar Technology
- Package Outline SOT-89 (3pin), MTP5

■BLOCK DIAGRAM

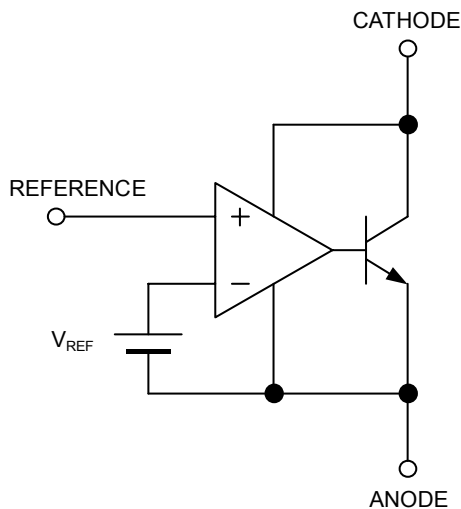

■PIN CONFIGURATION

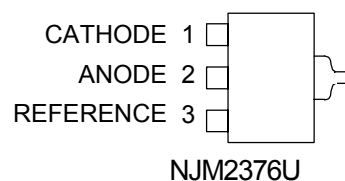
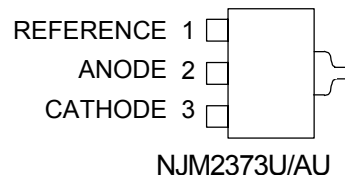
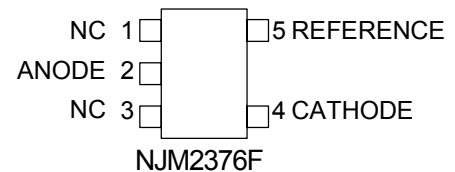
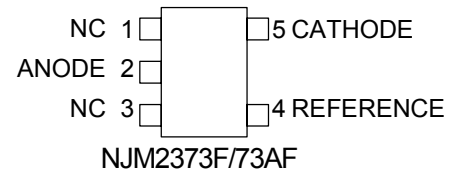

NJM2373/73A/76

■ABSOLUTE MAXIMUM RATINGS (Ta=25°C)

PARAMETER	SYMBOL	MAXIMUM RATINGS	UNIT
Cathode Voltage	V_{KA}	+14	V
Continuous Cathode Current	I_K	-30 ~ 50	mA
Reference Input Current	I_{REF}	-10 ~ 0.05	mA
Power Dissipation	P_D	(SOT-89) 350 (MTP5) 200	mW
Operating Temperature Range	T_{OPR}	-40 ~ +85	°C
Storage Temperature Range	T_{STG}	-40 ~ +150	°C

■RECOMMENDED OPERATING CONDITIONS (Ta=25°C)

PARAMETER	SYMBOL	MIN.	TYP.	MAX.	UNIT
Cathode Voltage	V_{KA}	V_{REF}	—	13	V
Cathode Current	I_K	1	—	30	mA

■ELECTRICAL CHARACTERISTICS ($I_K=1mA$, Ta=25°C)

PARAMETER	SYMBOL	TEST CONDITION	MIN.	TYP.	MAX.	UNIT
Reference Voltage	V_{REF}	$V_{KA}=V_{REF}$ NJM2373A (*1)	1225	1250	1275	mV
		$V_{KA}=V_{REF}$ NJM2373A/ NJM2376 (*1)	1237	1250	1263	
Reference Voltage Change vs. Cathode Voltage Change	$\Delta V_{REF}/\Delta V_{KA}$	$ V_{REF} \leq V_{KA} \leq 5V$ (*2)	—	—	± 2.7	mV/V
		$5V \leq V_{KA} \leq 13V$ (*2)	—	—	± 2.0	mV/V
Reference Input Current	I_{REF}	$V_{KA}=V_{REF}$ $R1=10k\Omega$, $R2=\infty$ (*2)	—	2.0	4.0	μA
Minimum Input Current	I_{MIN}	$V_{KA}=V_{REF}$, $\Delta V_{REF}=\pm 1\%$ (*1)	—	80	500	μA
Cathode Current (Off Cond.)	I_{OFF}	$V_{KA}=13V$, $V_{REF}=0V$ (*3)	—	0.01	1.0	μA
Dynamic Impedance	$ Z_{KA} $	$V_{KA}=V_{REF}$, $f \leq 1kHz$ $0.5mA \leq I_K \leq 30mA$ (*1)	—	0.12	—	Ω

■TEMPERATURE CHARACTERISTICS ($I_K=1mA$, Ta= -40°C ~ 85°C)

PARAMETER	SYMBOL	TEST CONDITION	MIN.	TYP.	MAX.	UNIT
Reference Voltage Change	ΔV_{REF}	$V_{KA}=V_{REF}$ (*1)	—	± 10	—	mV
Reference Input Current Change	ΔI_{REF}	$V_{KA}=V_{REF}$ $R1=10k\Omega$, $R2=\infty$ (*2)	—	0.5	—	μA

$|V_{REF}|$...Reference voltage includes error.

(*1): Test Circuit (Fig.1)

(*2): Test Circuit (Fig.2)

(*3): Test Circuit (Fig.3)

■TEST CIRCUIT

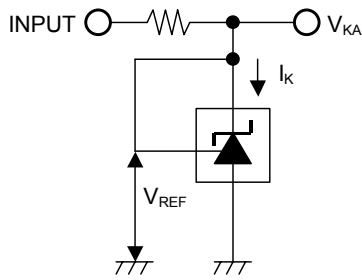

Fig.1 $V_{KA}=V_{REF}$ to test circuit

$$V_O = V_{KA} = V_{REF}$$

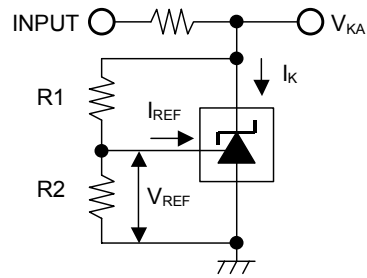

Fig.2 $V_{KA}>V_{REF}$ to test circuit

$$V_O = V_{KA} = V_{REF} \left(1 + \frac{R_1}{R_2} \right) + I_{REF} \times R_1$$

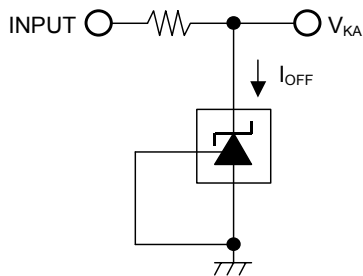

Fig.3 I_{OFF} to test circuit

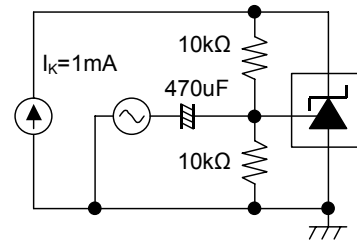
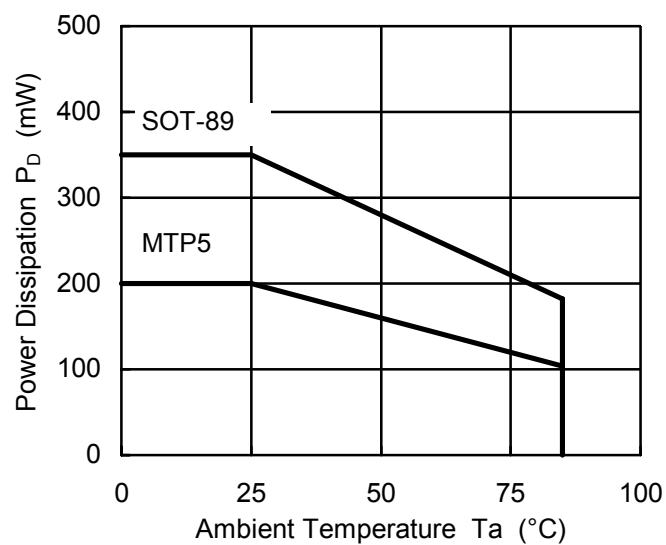

Fig.4 Gain and Phase to test circuit

■POWER DISSIPATION VS. AMBIENT TEMPERATURE



NJM2373/73A/76

■ TYPICAL CHARACTERISTICS

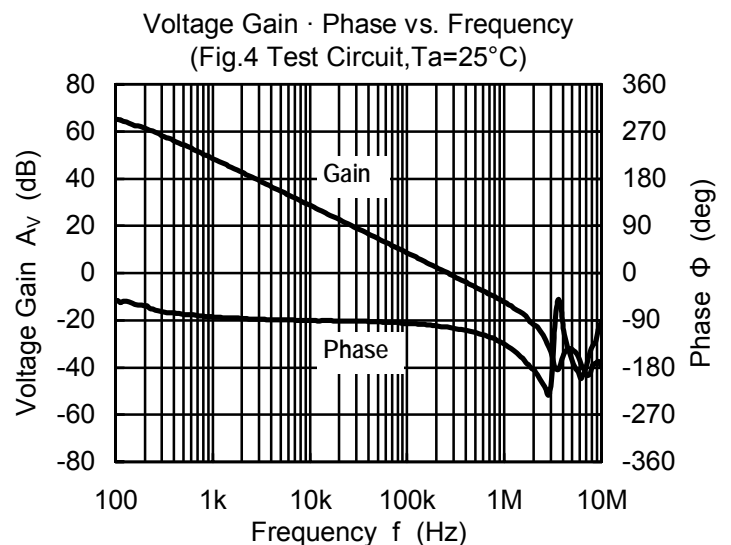
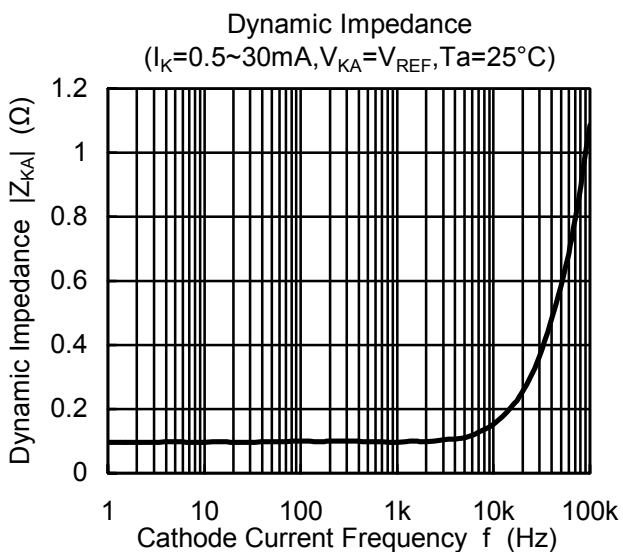
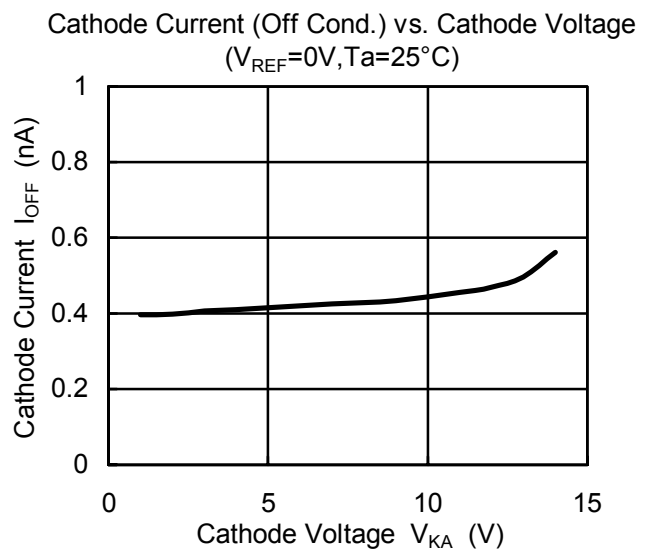
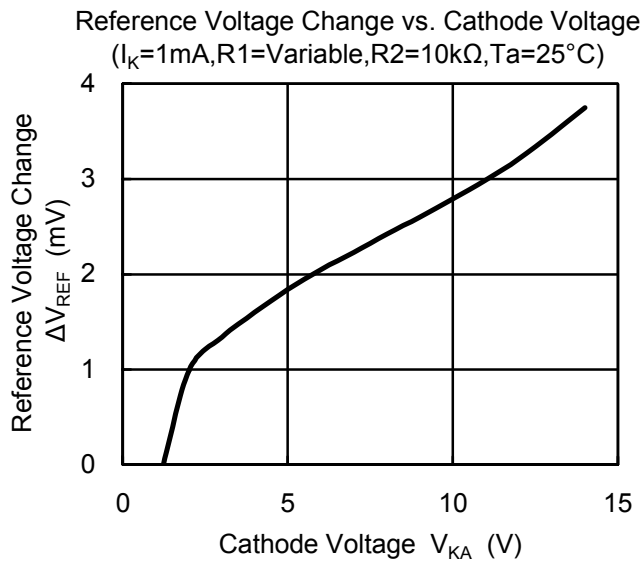
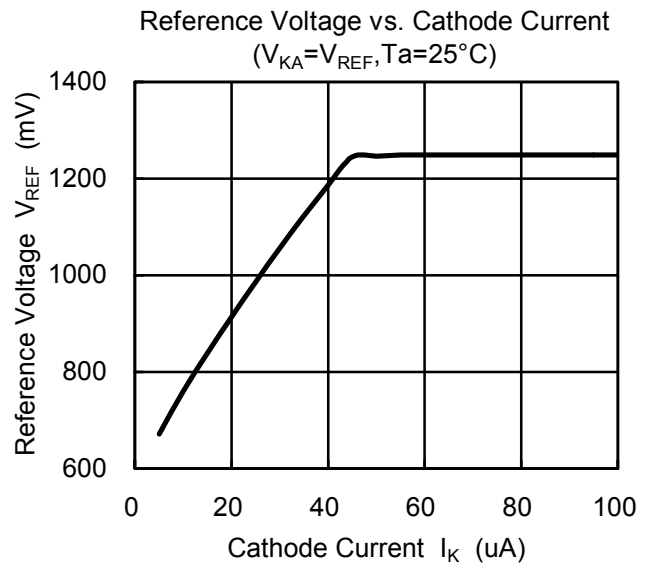
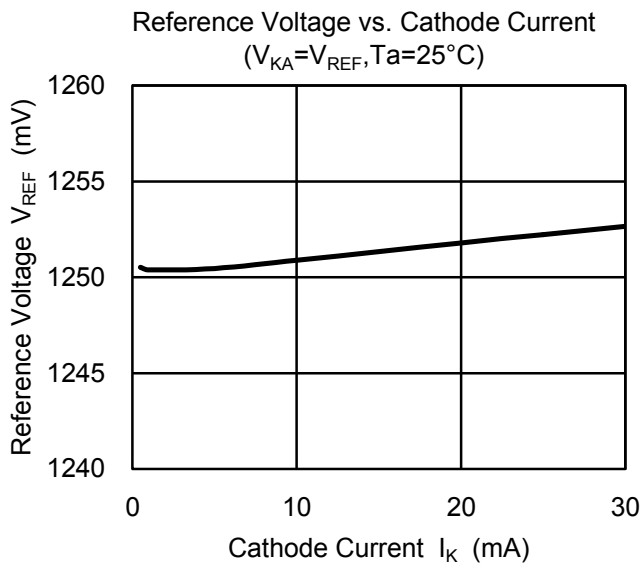

■ TYPICAL CHARACTERISTICS

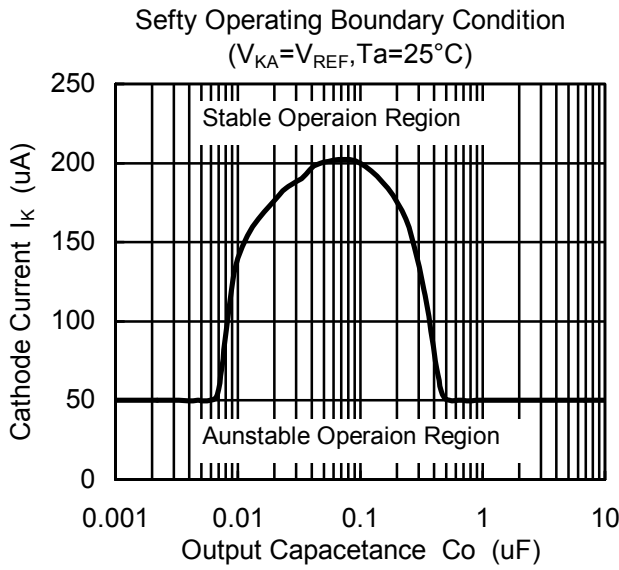

Note) Oscillation might occur while operating within the range of safety curve.

So that, it is necessary to make ample margins by taking considerations of fluctuation of the device.

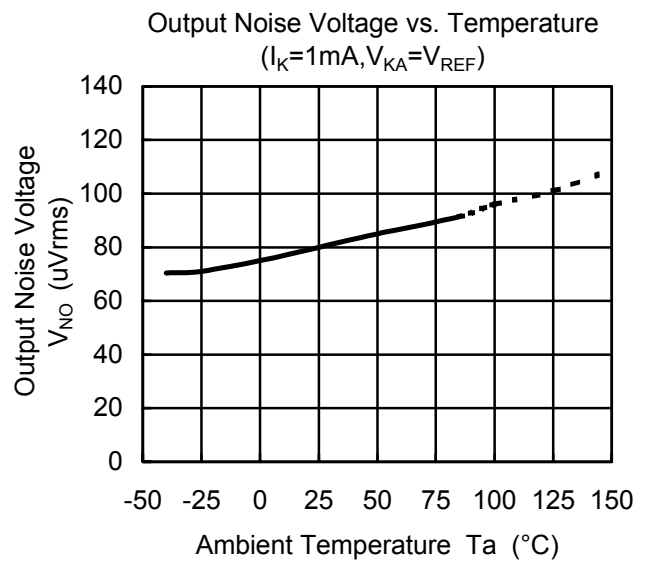
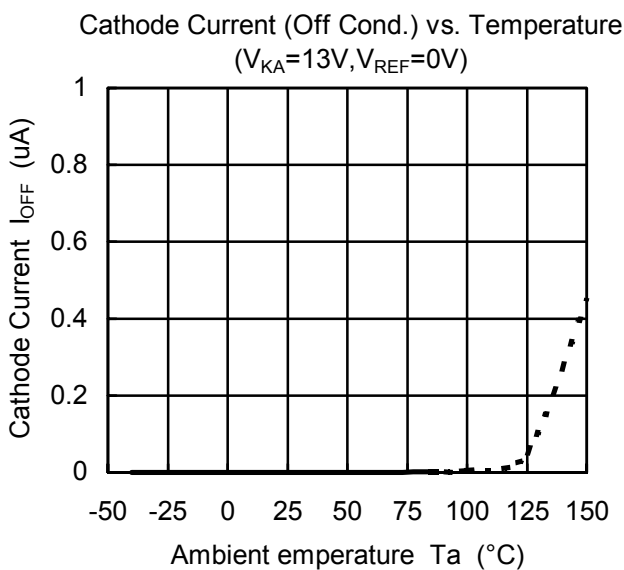
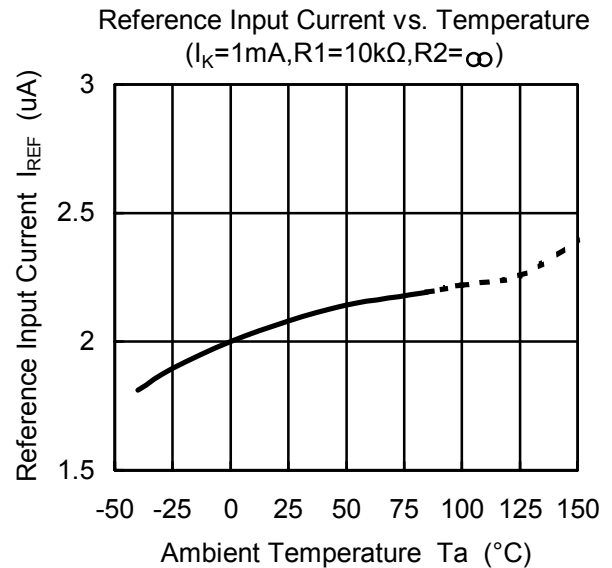
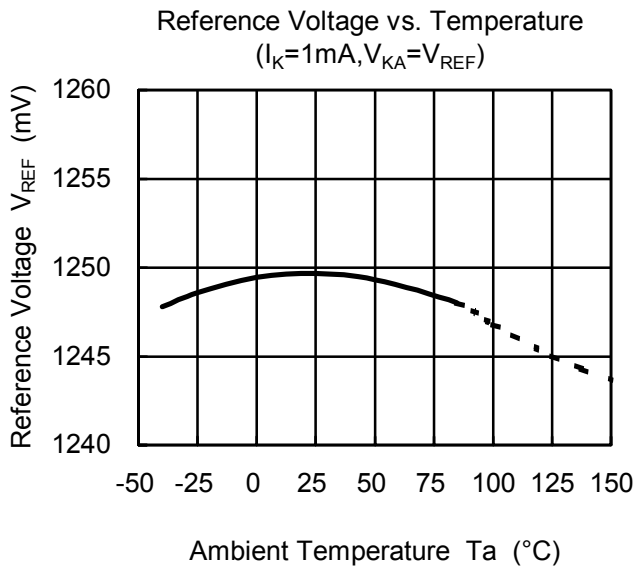

MEMO

[CAUTION]

The specifications on this databook are only given for information, without any guarantee as regards either mistakes or omissions. The application circuits in this databook are described only to show representative usages of the product and not intended for the guarantee or permission of any right including the industrial rights.