

RC0431A (RC431A)

Low-Voltage Adjustable Precision Shunt Regulator

Features

- Low voltage operation to 1.24V
- 1% reference voltage tolerance
- Output voltage adjustable from V_{ref} to 12V
- Low 80 μ A operational cathode current
- 0.25 Ω typical output impedance
- TO-92, SOT23-3 and SOT23-5 packages

Applications

- Voltage reference for discrete power circuits

Description

The RC0431A is a low-voltage 3-terminal adjustable precision voltage reference regulator. It has an excellent thermal stability over the standard commercial temperature range. The output voltage can be set to any value between V_{ref} (1.24V) and 12V using two external resistors. The RC0431A operates from a lower voltage (1.24V) than the traditional shunt regulator references which operate from 2.5V. When used with an optocoupler, the RC0431A will be an ideal voltage reference in an isolated feedback circuit for use in switched-mode power supplies and modular DC-DC converters. The RC0431A has a low output impedance of active output circuitry offering a very sharp turn-on characteristic. The RC0431A will be an excellent replacement for low-voltage zener diodes in many applications such as on-board regulation and adjustable power supplies.

Symbol

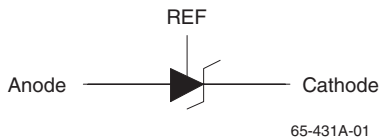

Block Diagram

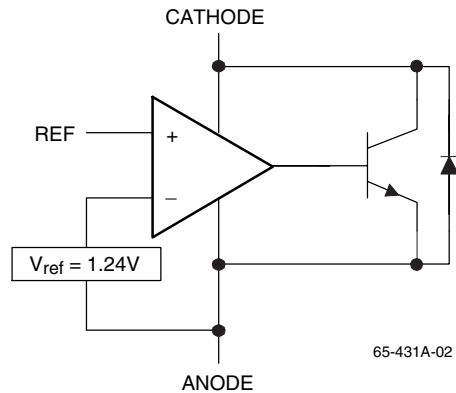

Pin Assignments

SOT-23 PACKAGE (3-Lead)
(TOP VIEW)

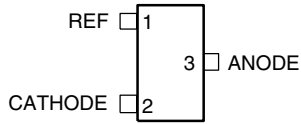

SOT-23 PACKAGE (5-Lead)
(TOP VIEW)

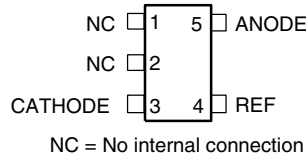

TO-92 PACKAGE
(TOP VIEW)

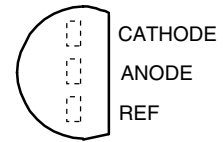

65-431A-03

Equivalent Schematic

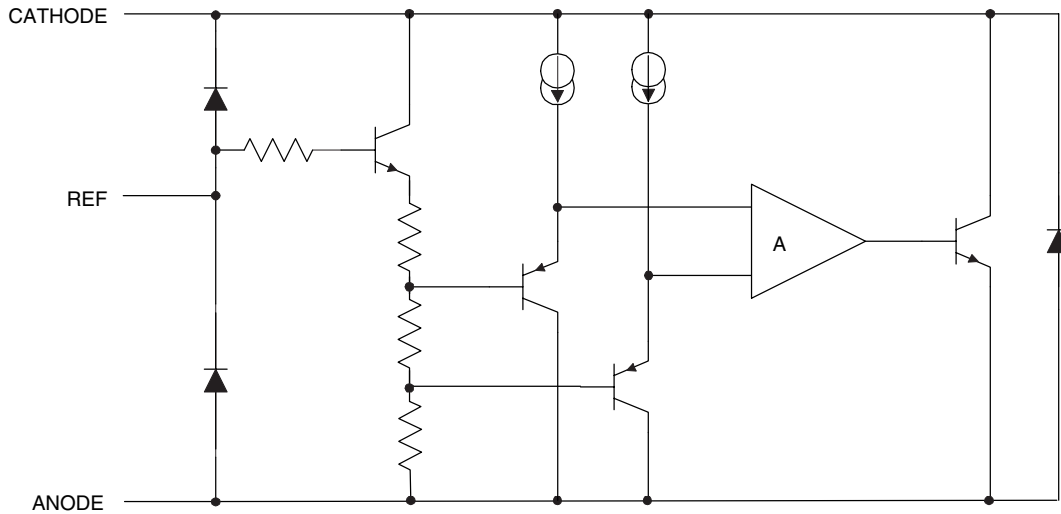

65-431A-04

Absolute Maximum Ratings

Ratings are over full operating free-air temperature range unless otherwise noted.

Cathode voltage, V_{KA}	13.2V
Continuous cathode current I_K	-20mA to 20mA
Reference current, I_{ref}	-0.05mA to 3mA
Power dissipation	See Dissipation Rating Table
Storage temperature range	-65° to 150°C

Notes:

- Functional operation under these conditions is not implied. Permanent damage may occur if the device is subjected to conditions outside these ratings.

Recommended Operating Conditions

Parameter	Min.	Max.	Units
Cathode voltage, V_{KA}	V_{REF}	12	V
Cathode current, I_K	0.1	15	mA
Operating temperature range in free-air, T_A	0	70	°C

Dissipation Rating Table

Package	Power Rating T _A ≤ 25°C	Derating Factor T _A ≥ 25°C	Power Rating T _A = 70°C
TO-92	775mW	6.2mW/°C	496mW
SOT23-5	150mW	1.2mW/°C	96mW

Electrical Specifications

T_A = 25°C (unless otherwise noted), at free-air

Symbol	Parameters	Conditions	Min.	Typ.	Max.	Units
V _{ref}	Reference Voltage	V _{KA} = V _{ref} , T _A = 25°C	1.228	1.24	1.252	V
		I _K = 10mA, T _A = 0 to 70°C	1.221		1.259	
V _{ref} (dev)	V _{ref} deviation over full temperature range (see note 2)	V _{KA} = V _{ref} , I _K = 10mA, See note 2 and Figure 1.		4	12	mV
$\frac{\Delta V_{ref}}{\Delta V_{KA}}$	Ratio of V _{ref} change in cathode voltage change	I _K = 10mA, ΔV _{KA} = V _{ref} to 6V. See figure 2.		-1.5	-2.7	$\frac{mV}{V}$
I _{ref}	Reference terminal current	I _K = 10mA, R ₁ = 10KΩ, R ₂ = ∞ See figure 2.		0.15	0.5	μA
I _{ref} (dev)	I _{ref} deviation over full temperature range (see note 2)	I _K = 10mA, R ₁ = 10KΩ, R ₂ = ∞ See note 1 & figure 2.		0.05	0.3	μA
I _K (min)	Minimum cathode current for regulation	V _{KA} = V _{ref} See figure 1.		55	80	μA
I _{off}	Off-state cathode current	V _{KA} = 6V, V _{ref} = 0 See figure 3.		0.001	0.1	μA
Z _{KA}	Dynamic impedance (see note 3)	V _{KA} = V _{ref} , f ≤ 1KHz I _K = 0.1mA to 15mA, See figure 1.		0.25	0.4	Ω

Notes:

- Functional operation under these conditions is not implied. Permanent damage may occur if the device is subjected to conditions outside these ratings.
- Full temperature range is 0°C to 70°C.
- The deviation parameters V_{ref}(dev) and I_{ref}(dev) are defined as the differences between the maximum and minimum values obtained over the rated temperature range. The average full-range temperature coefficient of the reference input voltage, ∞V_{ref}, is defined as:

$$|\infty V_{ref}| \langle \text{ppm}/^\circ\text{C} \rangle = \frac{\{V_{ref}(\text{dev})/V_{ref}(T_A = 25^\circ\text{C})\} \times 10^6}{\Delta T_A}$$

where ΔT_A is the rated operating free-air temperature range of the device.

∞V_{ref} can be positive or negative depending on whether minimum V_{ref} or maximum V_{ref}, respectively, occurs at the lower temperature.

- The dynamic impedance is defined as: |Z_{KA}| = ΔV_{KA} / ΔI_K

When the device is operating with two external resistors (see Figure 2), the total dynamic impedance of the circuit is given by:

$$|Z_{KA}| = \frac{\Delta V}{\Delta I} \approx |Z_{KA}| \times \left(1 + \frac{R_1}{R_2}\right)$$

Parameter Measurement Information

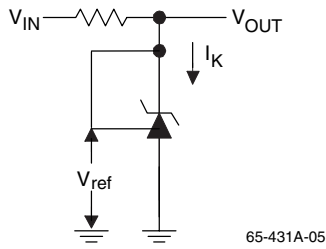

Figure 1. Test Circuit for $V_{KA} = V_{REF}$, $V_{OUT} = V_{KA} = V_{REF}$

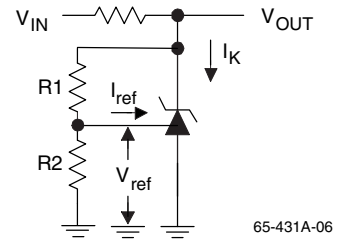

Figure 2. Test Circuit for $V_{KA} > V_{REF}$, $V_{OUT} = V_{KA} = V_{REF} \times (1 + R1/R2) + I_{REF} \times R1$

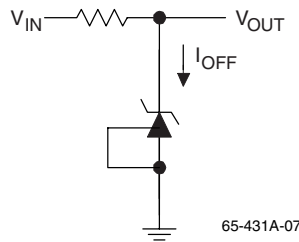

Figure 3. Test Circuit for I_{OFF}

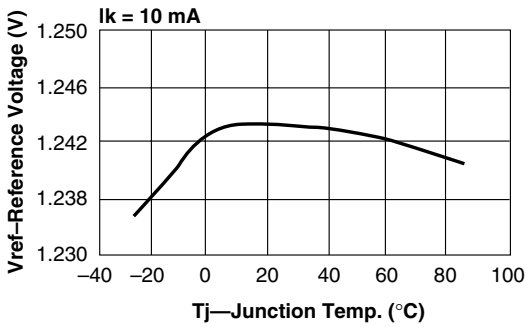

Figure 4. Reference Voltage vs. Junction Temp.

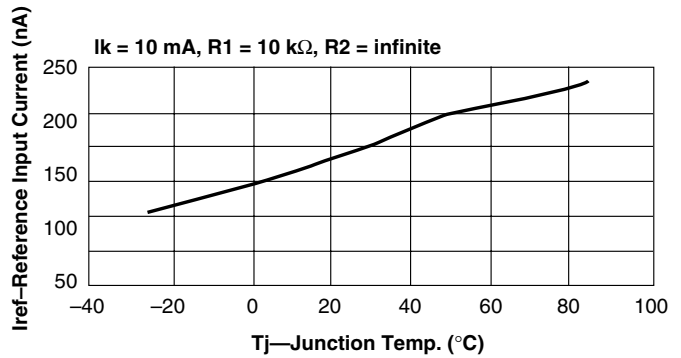

Figure 5. Reference Input Current vs. Junction Temp.

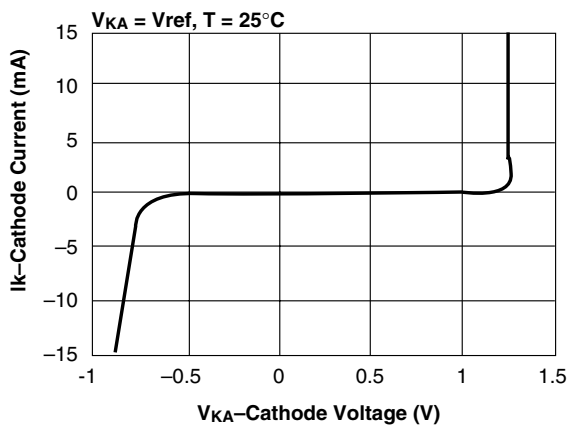

Figure 6. Cathode Current vs. Cathode Voltage

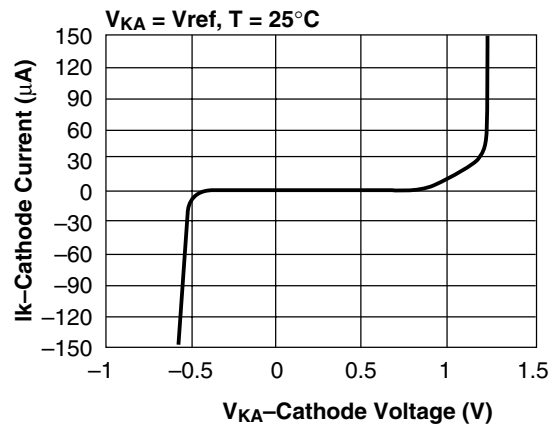

Figure 7. Cathode Current vs. Cathode Voltage

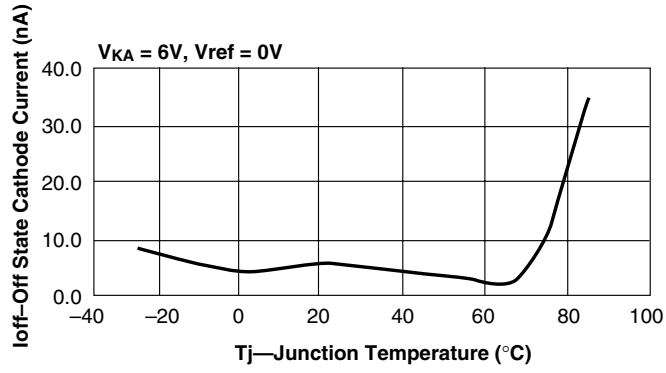

Figure 8. Off-State Cathode Current vs. Junction Temperature

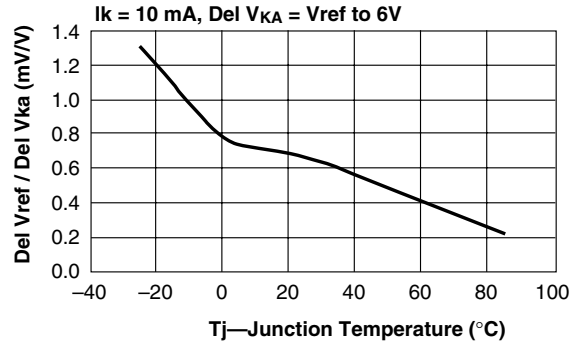

Figure 9. Ratio of Delta Reference Voltage to Delta Cathode Voltage vs. Junction Temperature

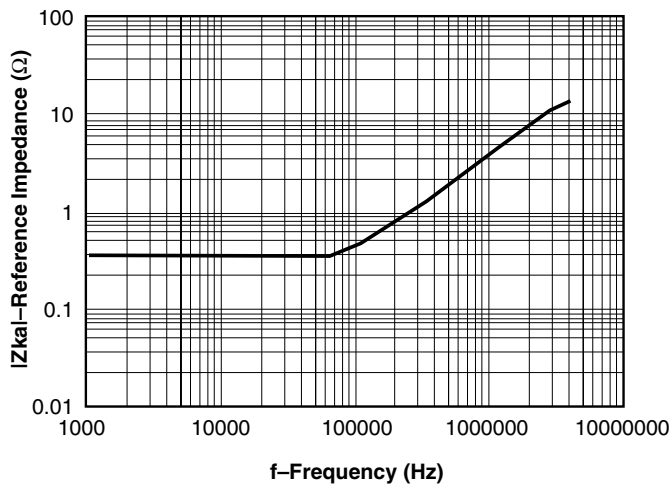

Figure 10. Reference Impedance vs. Frequency

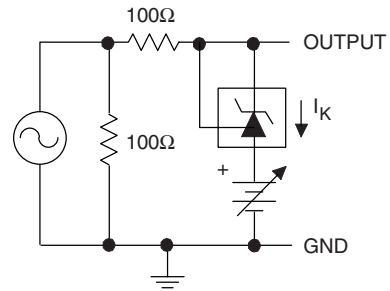

Figure 11. Test Circuit for Reference Impedance

Mechanical Dimensions

TO-92 Package

Symbol	Inches		Millimeters		Notes
	Min.	Max.	Min.	Max.	
A	.170	.210	4.32	5.33	
b	.015	.021	.38	.53	
c	.014	.020	.36	.51	
øD	.175	.205	4.45	5.21	
E	.125	.165	3.18	4.19	
e	.095	.105	2.41	2.67	
e1	.045	.055	1.14	1.40	
L	.500	—	12.70	—	
S	.080	.115	2.03	2.92	
α	4°	6°	4°	6°	

Notes:

1. Package outline exclusive of any mold flashes dimension.
2. Package outline exclusive of burr dimension.

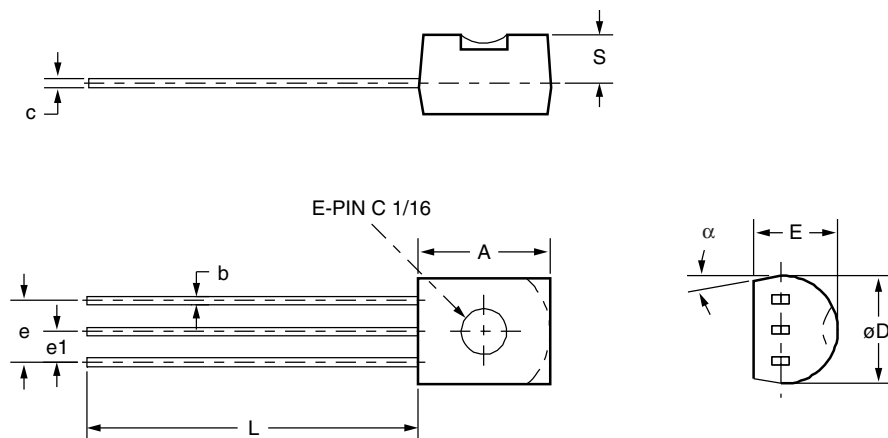

Mechanical Dimensions (continued)

SOT23-5 Package

SOT23 5-Lead

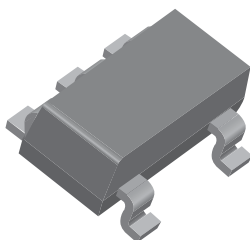

Symbol	Inches		Millimeters		Notes
	Min.	Max.	Min.	Max.	
A	.035	.057	.90	1.45	
A1	.000	.006	.00	.15	
B	.008	.020	.20	.50	
c	.003	.010	.08	.25	
D	.106	.122	2.70	3.10	
E	.059	.071	1.50	1.80	
e	.037 BSC		.95 BSC		
e1	.075 BSC		1.90 BSC		
H	.087	.126	2.20	3.20	
L	.004	.024	.10	.60	
	0	10	0	10	

Notes:

1. Package outline exclusive of mold flash & metal burr.
2. Package outline exclusive of solder plating.
3. EIAJ Ref Number SC-74A.

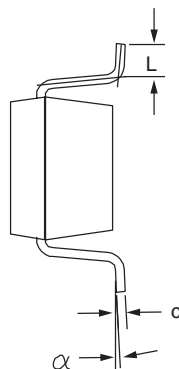
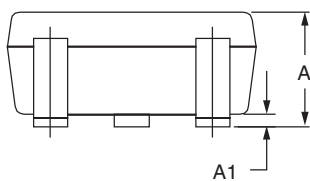
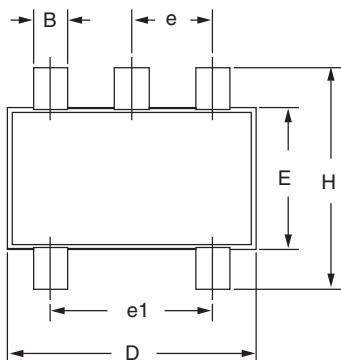

Mechanical Dimensions (continued)

SuperSOT™-3 Package

SuperSOT™-3 (FS PKG Code 32)

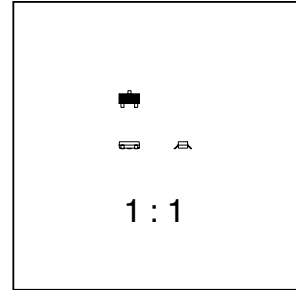
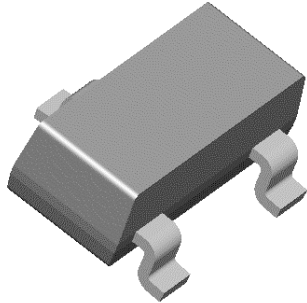

Scale 1:1 on letter size paper

Dimensions shown below are in:
inches [millimeters]

Part Weight per unit (gram): 0.0097

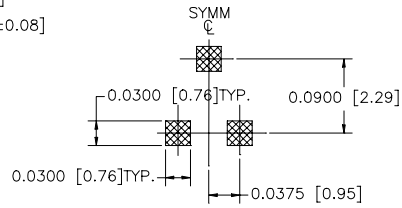
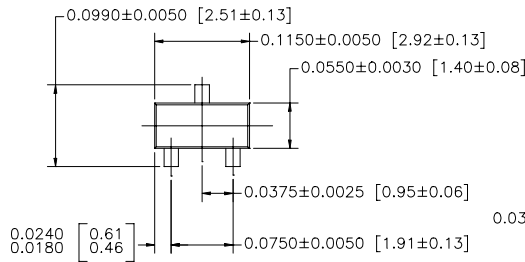

LAND PATTERN RECOMMENDATION

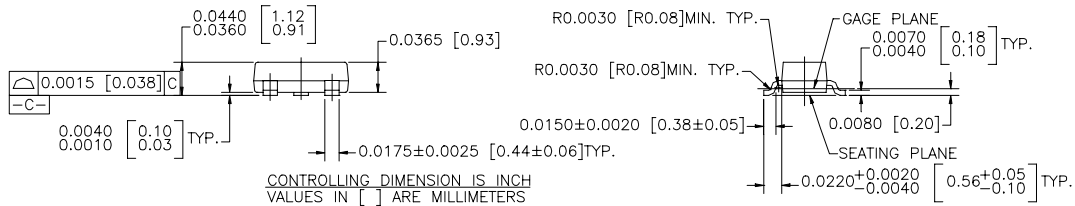

CONTROLLING DIMENSION IS INCH
 VALUES IN [] ARE MILLIMETERS

NOTES : UNLESS OTHERWISE SPECIFIED

SUPER SOT , 3 LEADS

- STANDARD LEAD FINISH TO BE 150 MICROINCHES / 3.81 MICROMETERS MINIMUM TIN/LEAD (SOLDER) ON COPPER.
- NO JEDEC REGISTRATION AS OF DEC. 1995.

Ordering Information

Product Number	Package
RC0431AM	SOT23-5
RC0431AT	TO-92
RC0431AS	SOT23-3

DISCLAIMER

FAIRCHILD SEMICONDUCTOR RESERVES THE RIGHT TO MAKE CHANGES WITHOUT FURTHER NOTICE TO ANY PRODUCTS HEREIN TO IMPROVE RELIABILITY, FUNCTION OR DESIGN. FAIRCHILD DOES NOT ASSUME ANY LIABILITY ARISING OUT OF THE APPLICATION OR USE OF ANY PRODUCT OR CIRCUIT DESCRIBED HEREIN; NEITHER DOES IT CONVEY ANY LICENSE UNDER ITS PATENT RIGHTS, NOR THE RIGHTS OF OTHERS.

LIFE SUPPORT POLICY

FAIRCHILD'S PRODUCTS ARE NOT AUTHORIZED FOR USE AS CRITICAL COMPONENTS IN LIFE SUPPORT DEVICES OR SYSTEMS WITHOUT THE EXPRESS WRITTEN APPROVAL OF THE PRESIDENT OF FAIRCHILD SEMICONDUCTOR CORPORATION. As used herein:

1. Life support devices or systems are devices or systems which, (a) are intended for surgical implant into the body, or (b) support or sustain life, and (c) whose failure to perform when properly used in accordance with instructions for use provided in the labeling, can be reasonably expected to result in a significant injury of the user.
2. A critical component in any component of a life support device or system whose failure to perform can be reasonably expected to cause the failure of the life support device or system, or to affect its safety or effectiveness.