

6

5

4

3

2

1

APPROVED: _____
 DATE: _____ TITLE: _____

Rev	AWO #	Description	Date	Appr
-		RELEASED	4/10/06	
A		ADDED SHT 2, TAPE & REEL SPEC	12/6/06	
B		REDRAWN	7/24/14	AY/GC
C		UPDATE SPEC.	6/21/16	AY/NC
D		UPDATE SPEC.	6/18/20	LH/DH

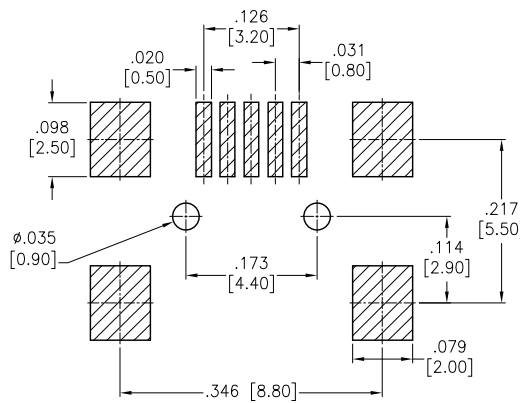
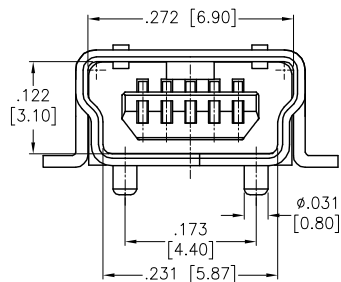
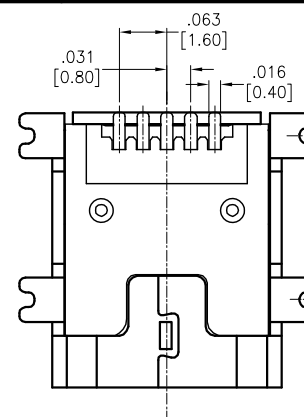
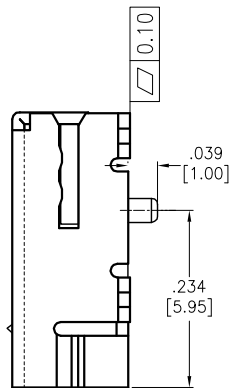
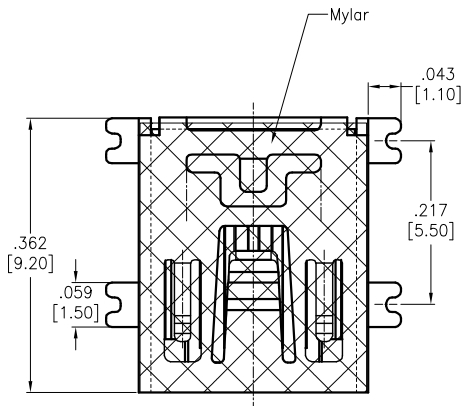

RECOMMENDED PCB LAYOUT

SPECIFICATIONS:

Material:
 Insulator: Hi-Temp Thermoplastic, rated UL94V-0
 Insulator color: Black
 Contacts: Phosphor Bronze
 Shell: Brass, Nickel plated
 Plating:
 Gold flash over Nickel underplate on contact area,
 Tin over Nickel underplate on solder tails
 Electrical:
 Voltage rating: 30 VAC.
 Current rating: 1 Amp.
 Contact resistance: 50 mohms max.
 Insulation resistance: 1000 MΩ min. @500 VDC
 Dielectric withstanding voltage: 100 VAC for 1 minute
 Temperature Rating:
 Operating temperature: -40°C to +85°C
 Environmental:
 Lead free, RoHS compliant.



PACKAGED ON TAPE & REEL

UNLESS OTHERWISE SPECIFIED ALL DIMENSIONS ARE INCHES [MM] TOLERANCES: EXCEPT AS NOTED INCHES HOLES .X ± .10 Ø.X ± .10 .XX ± .020 Ø.XX ± .015 .XXX ± .015 Ø.XXX ± .010		ADAM TECH INTERCONNECTS 909 Rahway Avenue, Union, NJ 07083 Phone: 908-687-5000 Fax: 908-687-5710	
APPROVALS DRAWN SS CHECKED APPROVED		DATE 10/4/04	
TITLE MINI USB, TYPE B, 5 pin, SINGLE PORT RIGHT ANGLE, SMT, TAPE AND REEL		SIZE X	PART NO. MUSB-B5-S-RA-SMT-PP-T/R
REF: S00005C		SCALE: NTS	REV. D SHEET 1 OF 2

6

5

4

3

2

1

6

5

4

3

2

1

APPROVED: _____

DATE: _____ TITLE: _____

Rev	AWO #	Description	Date	Appr
-----	-------	-------------	------	------

SEE SHT 1 OF 2 FOR REVISION

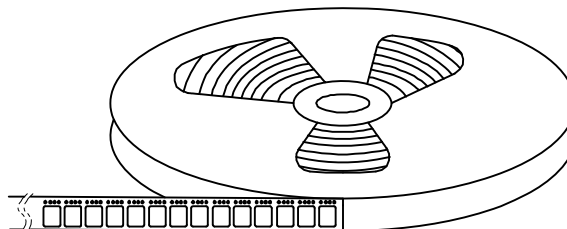
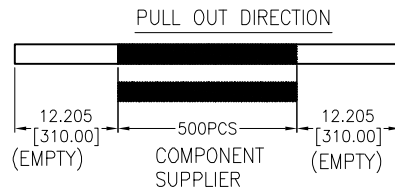
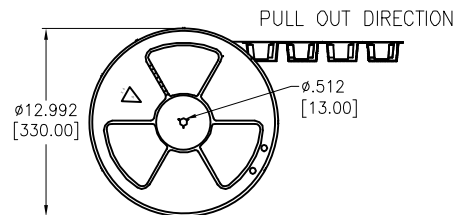
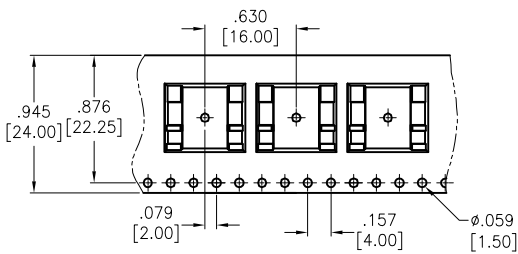

UNLESS OTHERWISE SPECIFIED
 ALL DIMENSIONS ARE INCHES [MM]
 TOLERANCES: EXCEPT AS NOTED

INCHES		HOLES	
.X	± .10	Ø.X	± .10
.XX	± .020	Ø.XX	± .015
.XXX	± .015	Ø.XXX	± .010

ADAM
TECH
 INTERCONNECTS

909 Rahway Avenue,
 Union, NJ 07083
 Phone: 908-687-5000
 Fax: 908-687-5710

APPROVALS		DATE
DRAWN	SS	10/4/04
CHECKED		
APPROVED		

TITLE		
MINI USB, TYPE B, 5 pin, SINGLE PORT RIGHT ANGLE, SMT, TAPE AND REEL		
SIZE	PART NO.	REV.
X	MUSB-B5-S-RA-SMT-PP-T/R	D
REF:	S00005C	SCALE: NTS
		SHEET 2 OF 2

6

5

4

3

2

1