

APPROVED: _____
 DATE: _____ TITLE: _____

Rev	AWO #	Description	Date	Appr
-		RELEASED	3/9/21	
A		ADDED PACKING	4/27/21	LH/RC

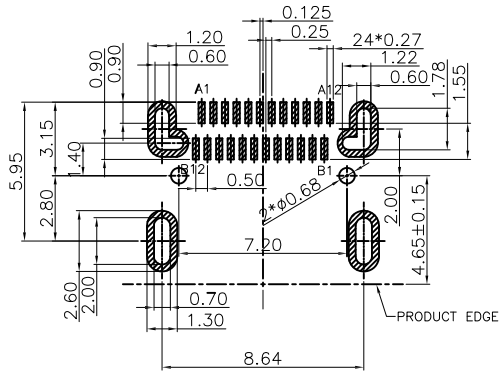

RECOMMENDED PCB LAYOUT

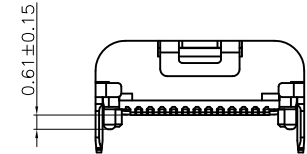
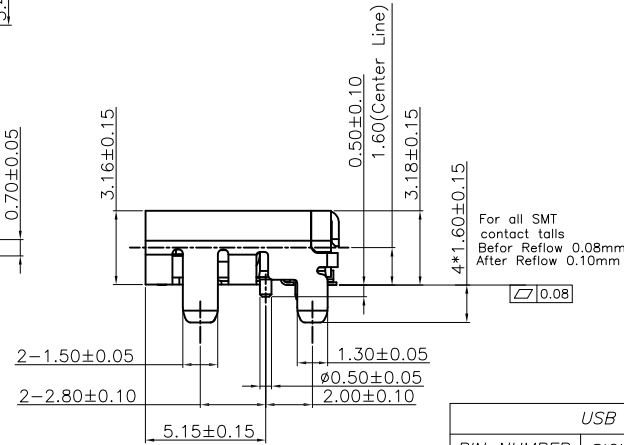
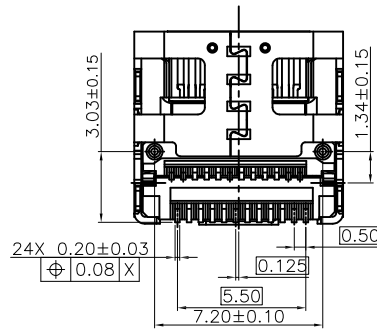
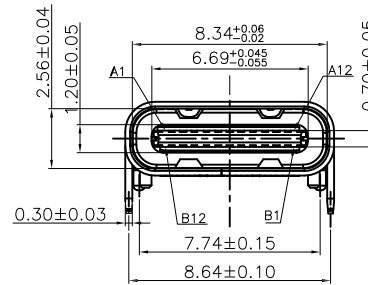
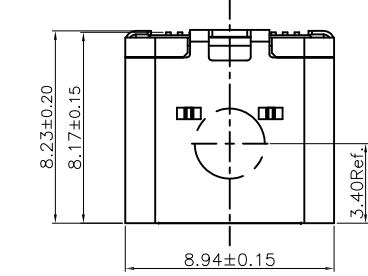

USB TYPE-C PIN ASSIGNMENTS			
PIN NUMBER	SIGNAL NAME	PIN NUMBER	SIGNAL NAME
A1	GND	B12	GND
A2	TX1+	B11	RX1+
A3	TX1-	B10	RX1-
A4	Vbus	B9	Vbus
A5	CC1	B8	SBU2
A6	Dp1	B7	Dn2
A7	Dn1	B6	Dp2
A8	SBU1	B5	CC2
A9	Vbus	B4	Vbus
A10	RX2-	B3	TX2-
A11	RX2+	B2	TX2+
A12	GND	B1	GND

B SPECIFICATIONS:

Material:
 Insulator: Hi-Temp Thermoplastic, rated UL 94V-0
 Insulator color: Black
 Contacts: Copper Alloy
 Shell: Stainless Steel, Nickel Plated
 Mid Plate: Steel, Nickel Plated
 Plating:
 30u" Gold over Nickel underplate on contact area
 Matte Tin over Nickel underplate on solder tails
 Electrical:
 Max Voltage : 20V
 Current rating: 5 Amp For VBUS Pin
 1.25 Amp For Vconn Pin
 Contact resistance: 30 mohms initial
 Insulation resistance: 100 Mohms min
 Dielectric withstanding voltage: 100 VAC R.M.S
 Mechanical:
 Mating cycles: 10,000 insertions
 Temperature Rating:
 Operating temperature: -40°C to +85°C
 Environmental:
 Lead free, RoHS compliant



PACKAGED ON TAPE & REEL

UNLESS OTHERWISE SPECIFIED ALL DIMENSIONS ARE ARE MILLIMETERS. TOLERANCES: EXCEPT AS NOTED		
MM	ANGLE	
0. ± 0.50	± 5°	
.0 ± 0.30		
.00 ± 0.20		
DRAWN	LH	3/9/21
CHECKED	RC	3/9/21
APPROVED		
THIS DRAWING CONTAINS INFORMATION THAT IS PROPRIETARY AND SHOULD NOT BE USED WITHOUT PRIOR WRITTEN PERMISSION FROM ADAM TECH		



909 Rahway Avenue,
 Union, NJ 07083
 Phone: 908-687-5000
 Fax: 908-687-5710

TITLE USB 4.0, TYPE C, FEMALE, RIGHT ANGLE, 40Gbps, BLACK INSULATOR, 30u" SEL GOLD PLATED		
SIZE X	PART NO. USB-C40-S-RA-CS1-SMT-BK-30-T/R	REV. A
REF: S00005C	SCALE: NTS	SHEET 1 OF 2

6

5

4

3

2

1

APPROVED: _____

DATE: _____ TITLE: _____

Rev	AWO #	Description	Date	Appr
-----	-------	-------------	------	------

SEE SHT 1 OF 2 FOR REVISION

PACKAGING MESSAGE	SPECIFICATION
CARTON	350*350*340MM
TRIANGULAR CARDBOARD	410*305*6MM
CARRIER TAPE	W=24 P=16 M=11.7 PET
PROTECTIVE TAPE	W=24 T=0.3 1REEL/400 NATURAL
BUBBLE WRAP	350MM*350MM
PE BAG	500*760*0.03MM
REEL	ø300MM*24MM BLUE
COVER TAPE	W=21.3MM 1REEL=200 NATURAL

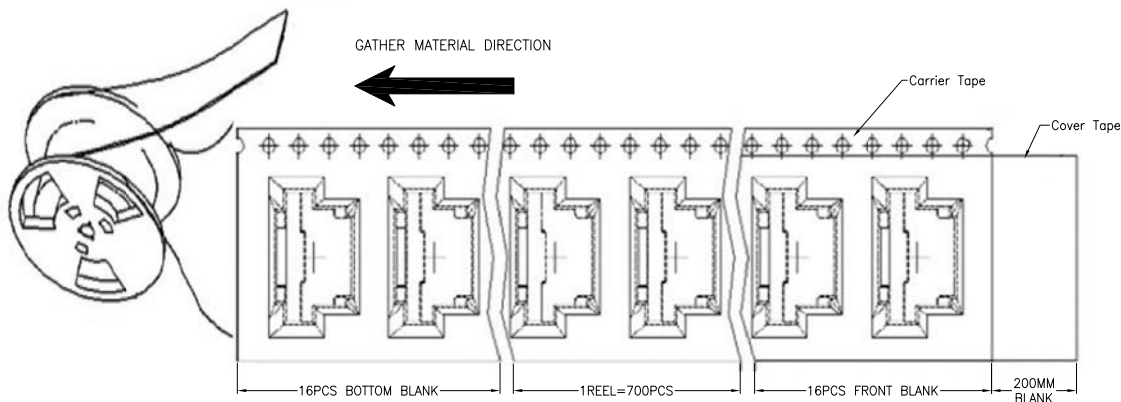

1REEL=700 PCS
 10 REEL/1 CARTON
 1CARTON=7000 PCS

UNLESS OTHERWISE SPECIFIED ALL DIMENSIONS ARE ARE MILLIMETERS. TOLERANCES: EXCEPT AS NOTED		
MM	ANGLE	
0. ± 0.50	± 5°	
.0 ± 0.30		
.00 ± 0.20		
DRAWN	LH	3/9/21
CHECKED	RC	3/9/21
APPROVED		
THIS DRAWING CONTAINS INFORMATION THAT IS PROPRIETARY AND SHOULD NOT BE USED WITHOUT PRIOR WRITTEN PERMISSION FROM ADAM TECH		

ADAM TECH 909 Rahway Avenue,
 Union, NJ 07083
 Phone: 908-687-5000
 Fax: 908-687-5710

TITLE: USB 4.0, TYPE C, FEMALE, RIGHT ANGLE,
 40Gbps, BLACK INSULATOR, 30u" SEL GOLD PLATED

SIZE	PART NO.	REV.
X	USB-C40-S-RA-CS1-SMT-BK-30-T/R	A
REF: S00005C	SCALE: NTS	SHEET 2 OF 2

6

5

4

3

2

1

D

D

C

C

B

B

A

A