

# 100Mbps, 16-Channel LLTs

## General Description

The MAX14548E/MAX14548AE 16-channel, bidirectional level translators (LLTs) provide the level shifting necessary for 100Mbps data transfer in multivoltage systems. Externally applied voltages,  $V_{CC}$  and  $V_L$ , set the logic levels on either side of the device. Logic signals present on the  $V_L$  side of the device appear as a high-voltage logic signal on the  $V_{CC}$  side of the device and vice versa.

The devices feature a programming frequency input (PF) that adjusts the one-shot accelerator on-time to guarantee a bit rate of 100Mbps with a load capacitance  $< 15\text{pF}$  and  $V_L > 1.1\text{V}$  (MAX14548E) or  $V_L > 1.4\text{V}$  (MAX14548AE) when driven low. The MAX14548E can drive capacitive loads up to 50pF with a guaranteed bit rate of 40Mbps when  $V_L \geq 1.1\text{V}$  and PF is driven high. The MAX14548AE can drive capacitive loads up to 50pF with a guaranteed bit rate of 40Mbps when  $V_L \geq 1.1\text{V}$  and PF is driven high.

The device operate at full speed with external drivers that source as low as 4mA output current. Each I/O channel is pulled up to  $V_{CC}$  or  $V_L$  by an internal 35 $\mu\text{A}$  current source, allowing both devices to be driven by either push-pull or open-drain drivers.

The devices feature multiple power-saving features including an enable input (EN) that places the device into a low-power shutdown mode when driven low and an automatic shutdown mode that disables the part when  $V_{CC}$  is less than  $V_L$ . The MAX14548AE output driver is designed to operate at full speed (100Mbps) with  $V_L > 1.4\text{V}$ , which reduces the dynamic supply current vs. the MAX14548E. The state of I/O  $V_{CC}$  and I/O  $V_L$  are in high-impedance state during shutdown.

The devices operate with  $V_{CC}$  voltages from +1.7V to +3.6V and  $V_L$  voltages from +1.1V to +3.6V, making them ideal for data transfer between low-voltage ASICs/PLDs and higher voltage systems. The devices are available in a 40-bump WLP (2.16mm x 3.46mm) package with 0.4mm ball pitch, and operate over the extended -40°C to +85°C temperature range.

## Features

- ◆ Bidirectional Level Translation
- ◆ 100Mbps Guaranteed Data Rate
- ◆ +1.7V to +3.6V Supply Voltage Range for  $V_{CC}$
- ◆ +1.1V to +3.6V Supply Voltage Range for  $V_L$  ( $V_{CC} > V_L$ )
- ◆ -40°C to +85°C Extended Operating Temperature Range

## Applications

CMOS Logic-Level Translation  
 Low-Voltage ASIC Level Translation  
 Smart Card Readers  
 Portable Communication Devices  
 Cell Phones  
 GPS  
 Telecommunications Equipment

*Typical Operating Circuit appears at end of data sheet.*

## Ordering Information/Selector Guide

PART	PIN-PACKAGE	BIT RATE (PF = LOW) LOAD CAPACITANCE $< 15\text{pF}$ (Mbps)	BIT RATE (PF = HIGH) LOAD CAPACITANCE $< 50\text{pF}$ (Mbps)	LOW DYNAMIC SUPPLY CURRENT
MAX14548EEWL+	40 WLP	100	40	—
MAX14548AEWL+	40 WLP	100	40	Yes ( $V_L > 1.1\text{V}$ )

**Note:** All devices operate over the -40°C to +85°C operating temperature range.

+Denotes a lead(Pb)-free/RoHS-compliant package.

# 100Mbps, 16-Channel LLTs

## ABSOLUTE MAXIMUM RATINGS

(All voltages referenced to GND.)

VCC, VL, EN, PF.....	-0.3V to +4V
I/O VCC_ .....	-0.3V to (VCC + 0.3V)
I/O VL_ .....	-0.3V to (VL + 0.3V)
Short-Circuit Duration I/O VL_ , I/O VCC_ to GND .....	Continuous
Continuous Power Dissipation (TA = +70°C) 40-Bump WLP (derate 17.2mW/°C above +70°C) ....	1379mW

Junction-to-Ambient Thermal Resistance ( $\theta_{JA}$ )

(Note 1) .....	58°C/W
Operating Temperature Range .....	-40°C to +85°C
Storage Temperature Range.....	-65°C to +150°C
Junction Temperature .....	+150°C
Soldering Temperature (reflow) .....	+260°C

**Note 1:** Package thermal resistances were obtained using the method described in JEDEC specification JESD51-7, using a four-layer board. For detailed information on package thermal considerations, refer to [www.maxim-ic.com/thermal-tutorial](http://www.maxim-ic.com/thermal-tutorial).

Stresses beyond those listed under "Absolute Maximum Ratings" may cause permanent damage to the device. These are stress ratings only, and functional operation of the device at these or any other conditions beyond those indicated in the operational sections of the specifications is not implied. Exposure to absolute maximum rating conditions for extended periods may affect device reliability.

## ELECTRICAL CHARACTERISTICS

(VCC = +1.7V to +3.6V, VL = +1.1V to +3.6V, VCC > VL, EN = VL, CVCC = 1 $\mu$ F, CVL = 1 $\mu$ F, TA = -40°C to +85°C, unless otherwise noted. Typical values are at VCC = +2.8V, VL = +1.8V and TA = +25°C.) (Notes 2, 3)

PARAMETER	SYMBOL	CONDITIONS	MIN	TYP	MAX	UNITS
<b>POWER SUPPLIES</b>						
VL Supply Range	VL		1.1		3.6	V
VCC Supply Range	VCC		1.7		3.6	V
Supply Current from VCC	IQVCC	I/O VCC_ = VCC, I/O VL_ = VL			40	$\mu$ A
Supply Current from VL	IQVL	I/O VCC_ = VCC, I/O VL_ = VL			20	$\mu$ A
VCC Shutdown Supply Current	ISHDN-VCC	TA = +25°C, EN = GND, unconnected I/O pins		0.1	1	$\mu$ A
VL Shutdown Mode Supply Current	ISHDN-VL	TA = +25°C, EN = GND, unconnected I/O pins		0.1	1	$\mu$ A
		TA = +25°C, EN = VL, VCC = GND, unconnected I/O pins		0.1	2	
Dynamic Supply Current	ID	One I/O switching at 25MHz; all other I/O connected to VCC or VL; CLOAD = 0pF		2.9		mA
			MAX14548E		2.6	
I/O VCC_ , I/O VL_ Three-State Leakage Current	I <sub>LEAK</sub>	TA = +25°C, EN = GND		0.1	6	$\mu$ A
EN, PF Input Leakage Current	I <sub>LEAK_EN_PF</sub>	TA = +25°C			1	$\mu$ A
VL Shutdown Threshold	V <sub>TH_VL</sub>			0.3		V
VL - VCC Shutdown Threshold High	V <sub>TH_H</sub>	VCC rising (VL = 3.6V) (Note 4)	0.05	0.3	0.65	V
VL - VCC Shutdown Threshold Low	V <sub>TH_L</sub>	VCC falling (VL = 3.6V) (Note 4)	0.2	0.52	0.85	V
I/O VL_ Pullup Current	I <sub>VL_PU_</sub>	I/O VL_ = GND, I/O VCC_ = GND	10		125	$\mu$ A
I/O VCC_ Pullup Current	I <sub>VCC_PU_</sub>	I/O VCC_ = GND, I/O VL_ = GND	15		90	$\mu$ A
I/O VL_ to I/O VCC_ DC Resistance	R <sub>IOVL_IOVCC</sub>	(Note 5)		3		k $\Omega$

# 100Mbps, 16-Channel LLTs

MAX14548E/MAX14548AE

## ELECTRICAL CHARACTERISTICS (continued)

(VCC = +1.7V to +3.6V, VL = +1.1V to +3.6V, VCC > VL, EN = VL, CVCC = 1μF, CVL = 1μF, TA = -40°C to +85°C, unless otherwise noted. Typical values are at VCC = +2.8V, VL = +1.8V and TA = +25°C.) (Notes 2, 3)

PARAMETER	SYMBOL	CONDITIONS		MIN	TYP	MAX	UNITS
<b>ESD PROTECTION</b>							
I/O VCC_, I/O VL_		Human Body Model, CVCC = 1μF, CVL = 1μF	Unpowered device	±12		kV	
			Powered device	±5			
All Other Pins				±2			kV
<b>LOGIC LEVELS</b>							
I/O VL_ Input-Voltage High Threshold	VIHL	(Note 6)		VL - 0.2			V
I/O VL_ Input-Voltage Low Threshold	VILL	(Note 6)				0.15	V
I/O VCC_ Input-Voltage High Threshold	VIHC	(Note 6)		VCC - 0.4			V
I/O VCC_ Input-Voltage Low Threshold	VILC	(Note 6)				0.2	V
EN, PF Input-Voltage High Threshold	VIH	1.1V < VL < 1.3V		VL - 0.25			V
		VL = 1.8V		VL - 0.4			
EN, PF Input-Voltage Low Threshold	VIL	1.1V < VL < 1.3V				0.4	V
		VL = 1.8V				0.4	
I/O VL_ Output-Voltage High	VOHL	I/O VL_ source current = 10μA		4/5 x VL			V
I/O VL_ Output-Voltage Low, Drop to GND	VOLL	I/O VL_ sink current = 20μA, I/O VCC_ < 0.05V				1/3 x VL	V
I/O VCC_ Output-Voltage High	VOHC	I/O VCC_ source current = 10μA		4/5 x VCC			V
I/O VCC_ Output-Voltage Low, Drop to GND	VOLC	I/O VCC_ sink current = 20μA, I/O VL_ < 0.05V				1/3 x VCC	V
<b>RISE/FALL TIME ACCELERATOR STAGE</b>							
Accelerator Pulse Duration		PF = low	On rising edge	2.65			ns
			On falling edge	2.5			
		PF = high	On rising edge	4			ns
			On falling edge	3.7			
VL Output Accelerator Source Impedance		VL = 1.62V	7			Ω	
		VL = 3.2V	4.43				
VCC Output Accelerator Source Impedance		VCC = 2.2V	14.2			Ω	
		VCC = 3.6V	11.2				
VL Output Accelerator Sink Impedance		VL = 1.62V	15.3			Ω	
		VL = 3.2V	15.3				
VCC Output Accelerator Sink Impedance		VCC = 2.2V	20.3			Ω	
		VCC = 3.6V	19.5				

# 100Mbps, 16-Channel LLTs

## HIGH-SPEED TIMING CHARACTERISTICS—MAX14548E

( $V_{CC} = +1.7V$  to  $+3.6V$ ,  $V_L = +1.1V$  to  $+3.6V$ ,  $V_{CC} > V_L$ ,  $EN = V_L$ ,  $PF = low$ ,  $C_{VCC} = 1\mu F$ ,  $C_{VL} = 1\mu F$ ,  $C_{IOVL} \leq 15pF$ ,  $C_{IOVCC} \leq 15pF$ ,  $T_A = -40^\circ C$  to  $+85^\circ C$ , unless otherwise noted. Typical values are at  $V_{CC} = +2.8V$ ,  $V_L = +1.8V$  and  $T_A = +25^\circ C$ .) (Notes 2, 3)

PARAMETER	SYMBOL	CONDITIONS	MIN	TYP	MAX	UNITS
I/O $V_{CC}$ _ Rise Time	$t_{RVCC}$	Input rise time $< 2ns$ , Figure 1			2	ns
I/O $V_{CC}$ _ Fall Time	$t_{FVCC}$	Input fall time $< 2ns$ , Figure 1			2	ns
I/O $V_L$ _ Rise Time	$t_{RVL}$	Input rise time $< 2ns$ , Figure 2			2	ns
I/O $V_L$ _ Fall Time	$t_{FVL}$	Input fall time $< 2ns$ , Figure 2			2	ns
Propagation Delay (Driving I/O $V_L$ _)	$t_{PVL-VCC}$	Input rise time $< 2ns$ , Figure 1		2.75		ns
Propagation Delay (Driving I/O $V_{CC}$ _)	$t_{PVCC-VL}$	Input rise time $< 2ns$ , Figure 2		2.26		ns
Channel-to-Channel Skew	$t_{SKEW}$	Input rise time/fall time $< 2ns$		0.2		ns
Propagation Delay from I/O $V_L$ _ to I/O $V_{CC}$ _ After EN	$t_{EN-VCC}$	$R_{LOAD} = 1M\Omega$ , Figure 3		27		$\mu s$
Propagation Delay from I/O $V_{CC}$ _ to I/O $V_L$ _ After EN	$t_{EN-VL}$	$R_{LOAD} = 1M\Omega$ , Figure 3		0.05		$\mu s$
Maximum Data Rate		Push-pull operation	100			Mbps
		Open-drain operation	0.3			

## HIGH-SPEED TIMING CHARACTERISTICS—MAX14548AE

( $V_{CC} = +1.7V$  to  $+3.6V$ ,  $V_L = +1.4V$  to  $+3.6V$ ,  $V_{CC} > V_L$ ,  $EN = V_L$ ,  $PF = low$ ,  $C_{VCC} = 1\mu F$ ,  $C_{VL} = 1\mu F$ ,  $C_{IOVL} \leq 15pF$ ,  $C_{IOVCC} \leq 15pF$ ,  $T_A = -40^\circ C$  to  $+85^\circ C$ , unless otherwise noted. Typical values are at  $V_{CC} = +2.8V$ ,  $V_L = +1.8V$  and  $T_A = +25^\circ C$ .) (Notes 2, 3)

PARAMETER	SYMBOL	CONDITIONS	MIN	TYP	MAX	UNITS
I/O $V_{CC}$ _ Rise Time	$t_{RVCC}$	Input rise time $< 2ns$ , Figure 1			2	ns
I/O $V_{CC}$ _ Fall Time	$t_{FVCC}$	Input fall time $< 2ns$ , Figure 1			2	ns
I/O $V_L$ _ Rise Time	$t_{RVL}$	Input rise time $< 2ns$ , Figure 2			2	ns
I/O $V_L$ _ Fall Time	$t_{FVL}$	Input rise time $< 2ns$ , Figure 2			2	ns
Propagation Delay (Driving I/O $V_L$ _)	$t_{PVL-VCC}$	Input rise time $< 2ns$ , Figure 1		2.75		ns
Propagation Delay (Driving I/O $V_{CC}$ _)	$t_{PVCC-VL}$	Input rise time $< 2ns$ , Figure 2		2.26		ns
Channel-to-Channel Skew	$t_{SKEW}$	Input rise time/fall time $< 2ns$		0.2		ns
Propagation Delay from I/O $V_L$ _ to I/O $V_{CC}$ _ After EN	$t_{EN-VCC}$	$R_{LOAD} = 1M\Omega$ , Figure 3		27		$\mu s$
Propagation Delay from I/O $V_{CC}$ _ to I/O $V_L$ _ After EN	$t_{EN-VL}$	$R_{LOAD} = 1M\Omega$ , Figure 3		0.05		$\mu s$
Maximum Data Rate		Push-pull operation	100			Mbps
		Open-drain operation	0.3			

# 100Mbps, 16-Channel LLTs

MAX14548E/MAX14548AE

## LOW-SPEED TIMING CHARACTERISTICS—MAX14548E

(V<sub>CC</sub> = +1.7V to +3.6V, V<sub>L</sub> = +1.1V to +3.6V, V<sub>CC</sub> > V<sub>L</sub>, EN = V<sub>L</sub>, PF = high, C<sub>VCC</sub> = 1μF, C<sub>VL</sub> = 1μF, C<sub>I/OVL</sub> ≤ 50pF, C<sub>I/OVCC</sub> ≤ 50pF, T<sub>A</sub> = -40°C to +85°C, unless otherwise noted. Typical values are at V<sub>CC</sub> = +2.8V, V<sub>L</sub> = +1.8V and T<sub>A</sub> = +25°C.) (Notes 2, 3)

PARAMETER	SYMBOL	CONDITIONS	MIN	TYP	MAX	UNITS
I/O V <sub>CC</sub> _ Rise Time	t <sub>RVCC</sub>	Input rise time < 6ns, Figure 1			6	ns
I/O V <sub>CC</sub> _ Fall Time	t <sub>FVCC</sub>	Input fall time < 6ns, Figure 1			6	ns
I/O V <sub>L</sub> _ Rise Time	t <sub>RVL</sub>	Input rise time < 6ns, Figure 2			6	ns
I/O V <sub>L</sub> _ Fall Time	t <sub>FVL</sub>	Input rise time < 6ns, Figure 2			6	ns
Propagation Delay (Driving I/O V <sub>L</sub> _)	t <sub>PVL-VCC</sub>	Input rise time < 6ns, Figure 1		4		ns
Propagation Delay (Driving I/O V <sub>CC</sub> _)	t <sub>PVCC-VL</sub>	Input rise time < 6ns, Figure 2		3.37		ns
Channel-to-Channel Skew	t <sub>SKEW</sub>	Input rise time/fall time < 6ns		0.2	0.5	ns
Propagation Delay from I/O V <sub>L</sub> _ to I/O V <sub>CC</sub> _ After EN	t <sub>EN-VCC</sub>	R <sub>LOAD</sub> = 1MΩ, Figure 3		27		μs
Propagation Delay from I/O V <sub>CC</sub> _ to I/O V <sub>L</sub> _ After EN	t <sub>EN-VL</sub>	R <sub>LOAD</sub> = 1MΩ, Figure 3		0.06		μs
Maximum Data Rate		Push-pull operation	40			Mbps
		Open-drain operation	0.3			

## LOW-SPEED TIMING CHARACTERISTICS—MAX14548AE

(V<sub>CC</sub> = +1.7V to +3.6V, V<sub>L</sub> = +1.1V to +3.6V, V<sub>CC</sub> > V<sub>L</sub>, EN = V<sub>L</sub>, PF = high, C<sub>VCC</sub> = 1μF, C<sub>VL</sub> = 1μF, C<sub>I/OVL</sub> ≤ 50pF, C<sub>I/OVCC</sub> ≤ 50pF, T<sub>A</sub> = -40°C to +85°C, unless otherwise noted. Typical values are at V<sub>CC</sub> = +2.8V, V<sub>L</sub> = +1.8V and T<sub>A</sub> = +25°C.) (Notes 2, 3)

PARAMETER	SYMBOL	CONDITIONS	MIN	TYP	MAX	UNITS
I/O V <sub>CC</sub> _ Rise Time	t <sub>RVCC</sub>	Input rise time < 6ns, Figure 1			6	ns
I/O V <sub>CC</sub> _ Fall Time	t <sub>FVCC</sub>	Input fall time < 6ns, Figure 1			6	ns
I/O V <sub>L</sub> _ Rise Time	t <sub>RVL</sub>	Input rise time < 6ns, Figure 2			6	ns
I/O V <sub>L</sub> _ Fall Time	t <sub>FVL</sub>	Input rise time < 6ns, Figure 2			6	ns
Propagation Delay (Driving I/O V <sub>L</sub> _)	t <sub>PVL-VCC</sub>	Input rise time < 6ns, Figure 1		4		ns
Propagation Delay (Driving I/O V <sub>CC</sub> _)	t <sub>PVCC-VL</sub>	Input rise time < 6ns, Figure 2		3.37		ns
Channel-to-Channel Skew	t <sub>SKEW</sub>	Input rise time/fall time < 6ns		0.2		ns
Propagation Delay from I/O V <sub>L</sub> _ to I/O V <sub>CC</sub> _ After EN	t <sub>EN-VCC</sub>	R <sub>LOAD</sub> = 1MΩ, Figure 3		27		μs
Propagation Delay from I/O V <sub>CC</sub> _ to I/O V <sub>L</sub> _ After EN	t <sub>EN-VL</sub>	R <sub>LOAD</sub> = 1MΩ, Figure 3		0.06		μs
Maximum Data Rate		Push-pull operation	40			Mbps
		Open-drain operation	0.3			

**Note 2:** All units are 100% production tested at T<sub>A</sub> = +25°C. Limits over the operating temperature range are guaranteed by design and not production tested.

**Note 3:** V<sub>L</sub> must be less than or equal to V<sub>CC</sub> during normal operation. However, V<sub>L</sub> can be greater than V<sub>CC</sub> during startup and shutdown conditions.

**Note 4:** When V<sub>CC</sub> is below V<sub>L</sub> by more than the V<sub>L</sub> - V<sub>CC</sub> shutdown threshold, the device turns off its pullup generators and I/O V<sub>CC</sub>\_ and I/O V<sub>L</sub>\_ enter their respective shutdown states.

**Note 5:** Guaranteed by design.

**Note 6:** Input thresholds are referenced to the boost circuit.

# 100Mbps, 16-Channel LLTs

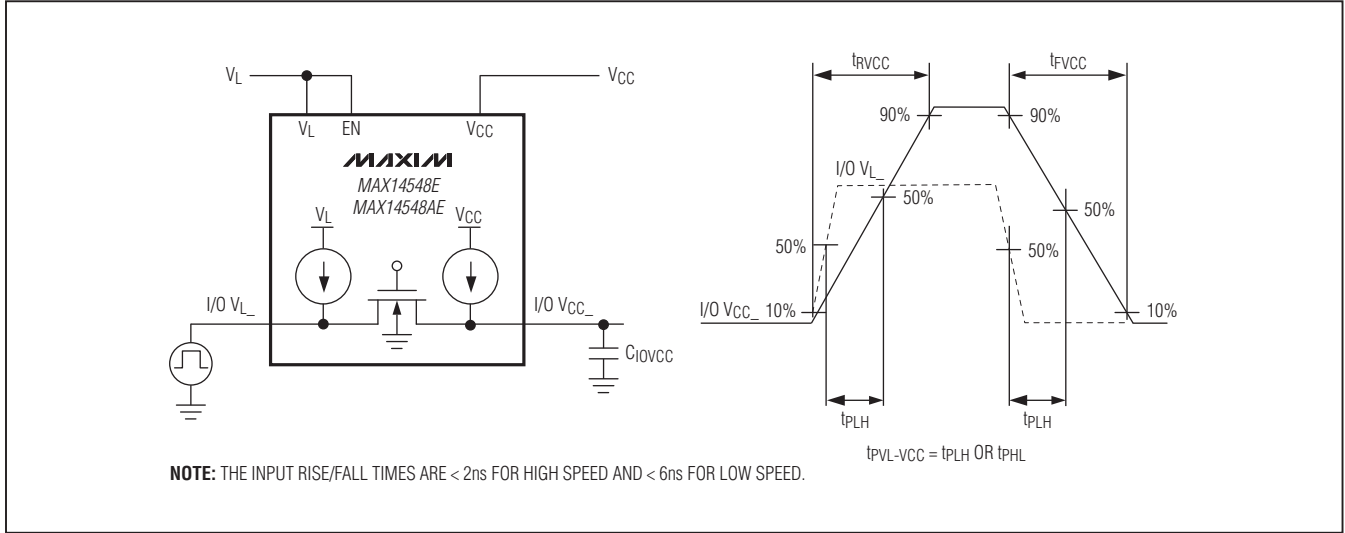

Figure 1. Push-Pull Driving I/O VL\_ Test Circuit and Timing

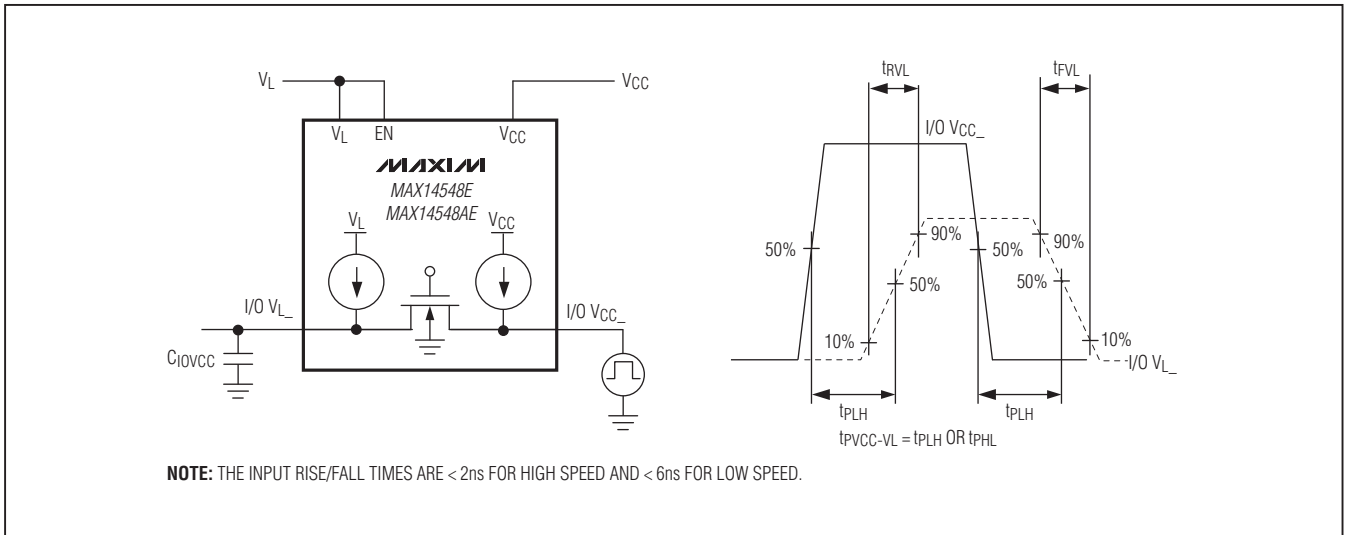

Figure 2. Push-Pull Driving I/O VCC\_ Test Circuit and Timing

# 100Mbps, 16-Channel LLTs

**MAX14548E/MAX14548AE**

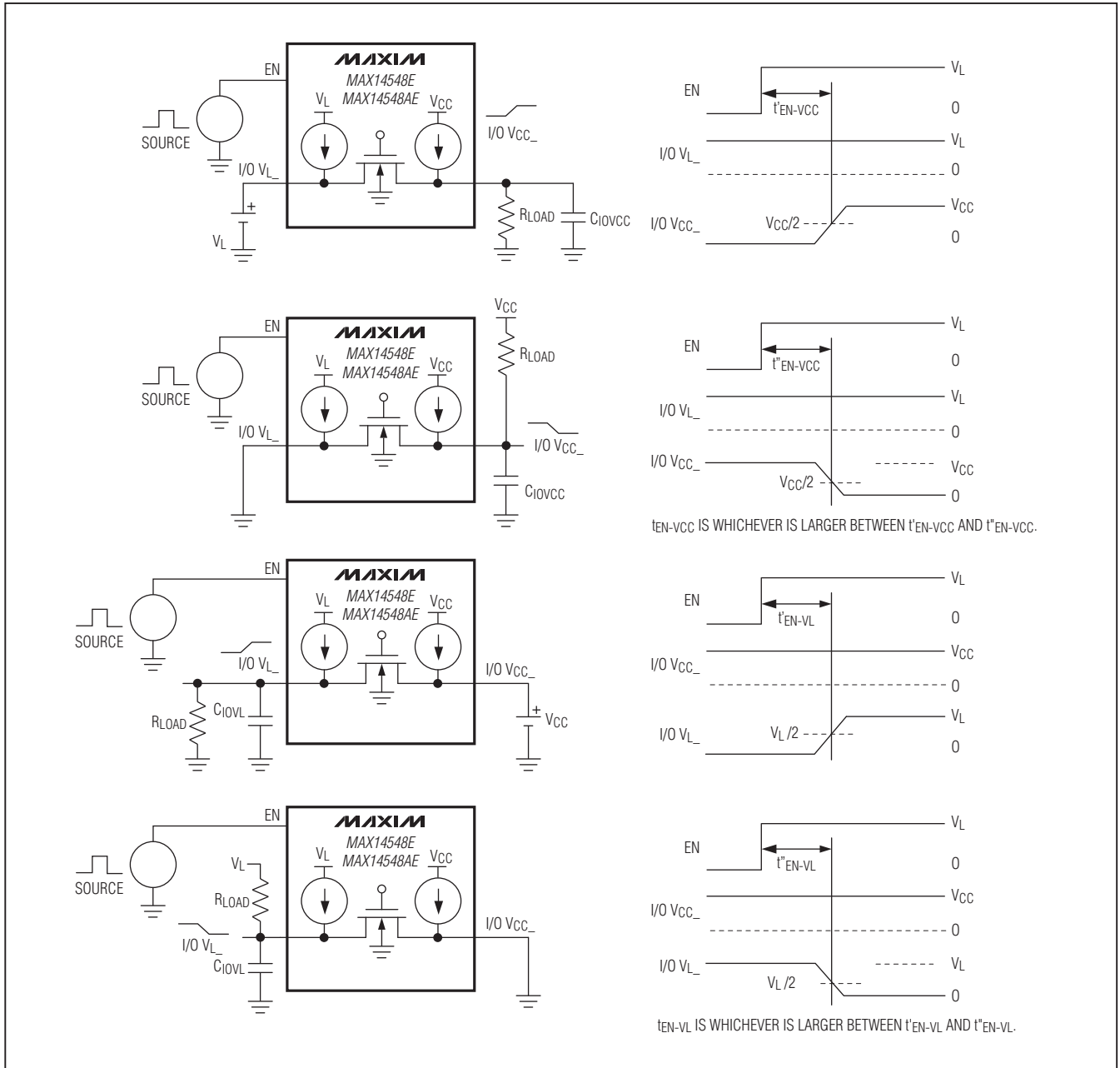
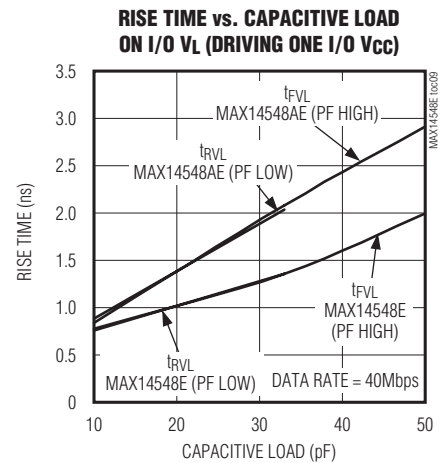
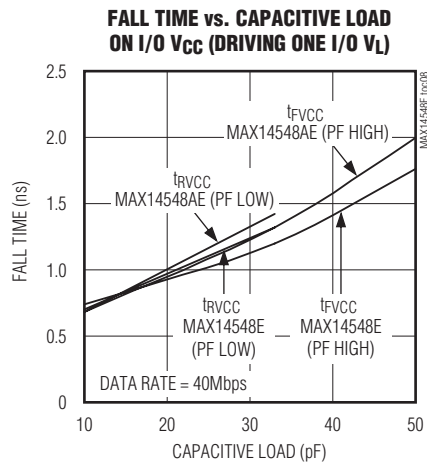
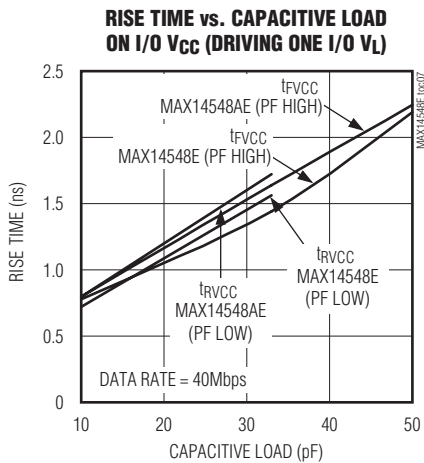
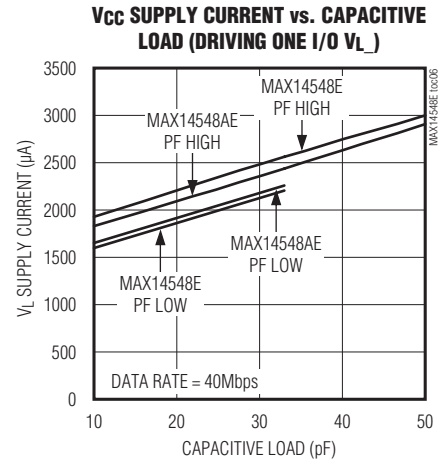
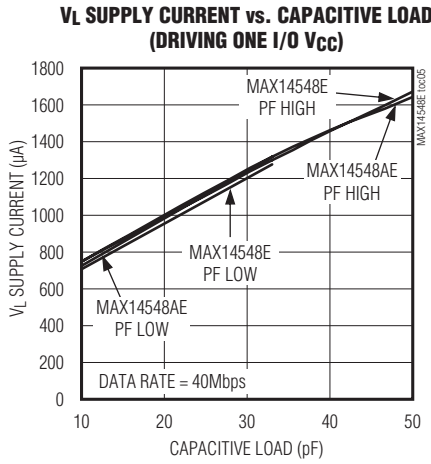
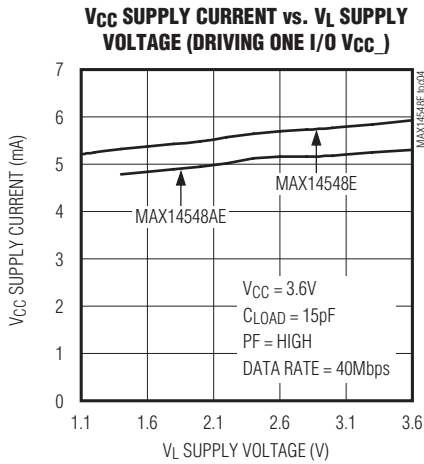
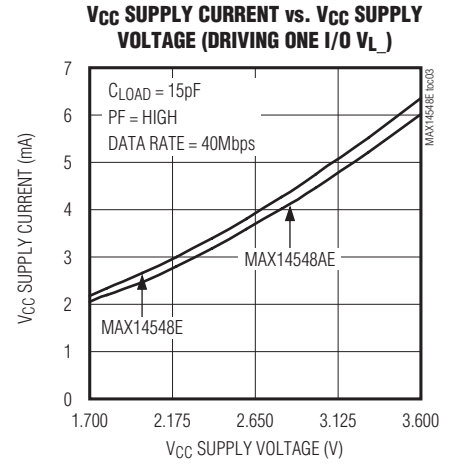
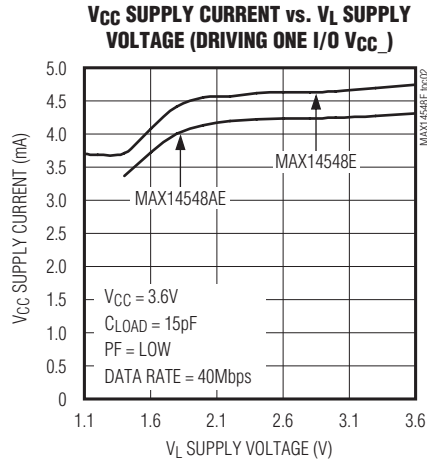
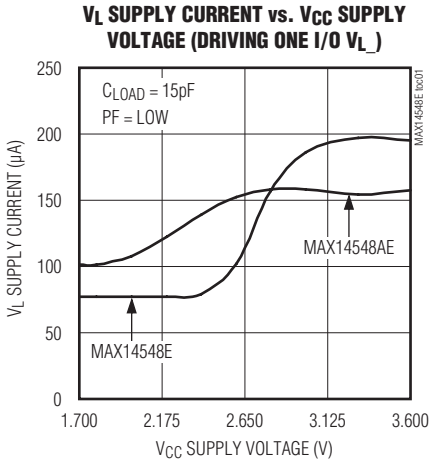

Figure 3. Enable Test and Timing

# 100Mbps, 16-Channel LLTs

## Typical Operating Characteristics

( $V_{CC} = 1.8V$ ,  $V_L = 1.4V$ ,  $C_L = 15pF$ ,  $R_{SOURCE} = 150\Omega$ , data rate = 100Mbps, push-pull driver,  $T_A = +25^\circ C$ , unless otherwise noted.)





# 100Mbps, 16-Channel LLTs

MAX14548E/MAX14548AE

## Typical Operating Characteristics (continued)

( $V_{CC} = 1.8V$ ,  $V_L = 1.4V$ ,  $C_L = 15pF$ ,  $R_{SOURCE} = 150\Omega$ , data rate = 100Mbps, push-pull driver,  $T_A = +25^\circ C$ , unless otherwise noted.)

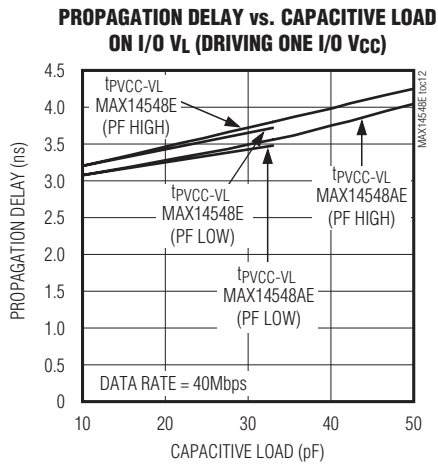
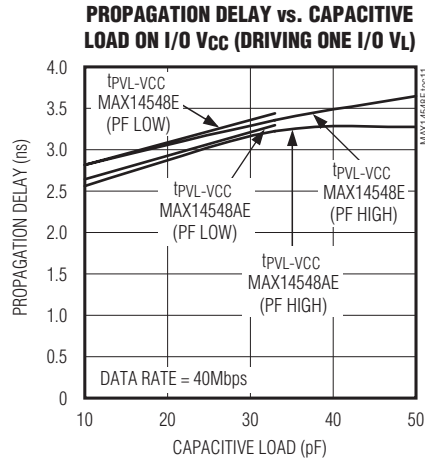
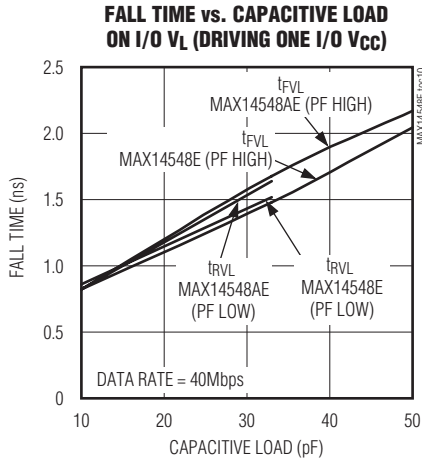

**TYPICAL I/O  $V_L$  DRIVING**  
(DATA RATE = 100Mbps,  $C_{IOVCC} = 10pF$ ,  
PF = LOW, MAX14548E)

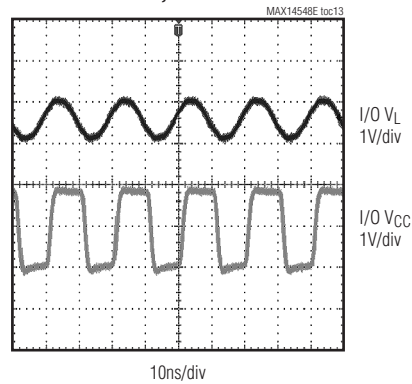

**TYPICAL I/O  $V_L$  DRIVING**  
(DATA RATE = 40Mbps,  $C_{IOVCC} = 47pF$ ,  
PF = HIGH, MAX14548E)

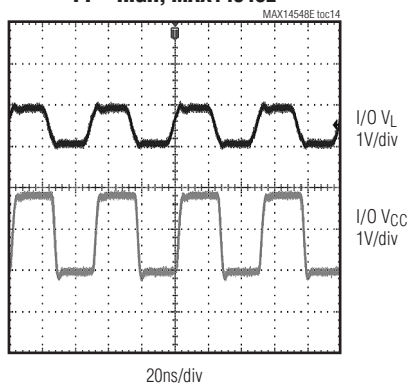

**TYPICAL I/O  $V_{CC}$  DRIVING**  
(DATA RATE = 100Mbps,  $C_{IOVL} = 10pF$ ,  
PF = LOW, MAX14548E)

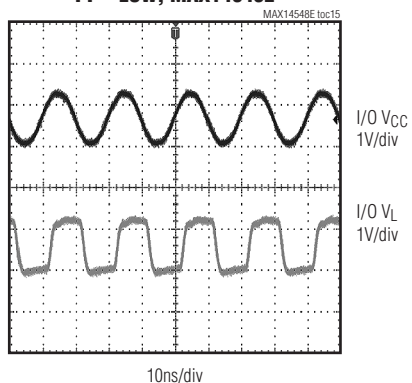

# 100Mbps, 16-Channel LLTs

## Typical Operating Characteristics (continued)

( $V_{CC} = 1.8V$ ,  $V_L = 1.4V$ ,  $C_L = 15pF$ ,  $R_{SOURCE} = 150\Omega$ , data rate = 100Mbps, push-pull driver,  $T_A = +25^\circ C$ , unless otherwise noted.)

**TYPICAL I/O  $V_{CC}$  DRIVING**  
 (DATA RATE = 40Mbps,  $C_{IOVL} = 47pF$ ),  
 PF = HIGH, MAX14548E

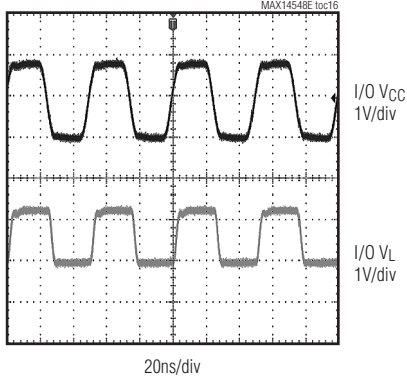

**TYPICAL I/O  $V_L$  DRIVING**  
 (DATA RATE = 100Mbps,  $C_{IOVCC} = 10pF$ ),  
 PF = LOW, MAX14548AE

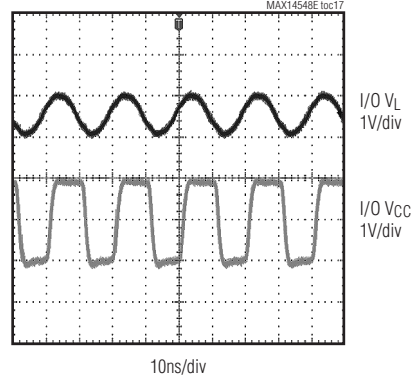

**TYPICAL I/O  $V_L$  DRIVING**  
 (DATA RATE = 40Mbps,  $C_{IOVCC} = 47pF$ ),  
 PF = HIGH, MAX14548E

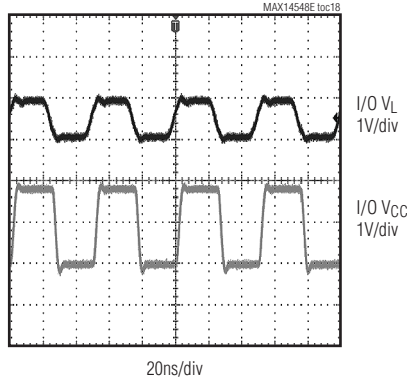

**TYPICAL I/O  $V_{CC}$  DRIVING**  
 (DATA RATE = 100Mbps,  $C_{IOVL} = 10pF$ ),  
 PF = LOW, MAX14548AE

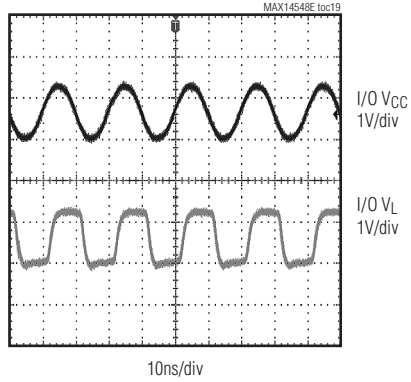

**TYPICAL I/O  $V_{CC}$  DRIVING**  
 (DATA RATE = 40Mbps,  $C_{IOVL} = 47pF$ ),  
 PF = HIGH, MAX14548AE

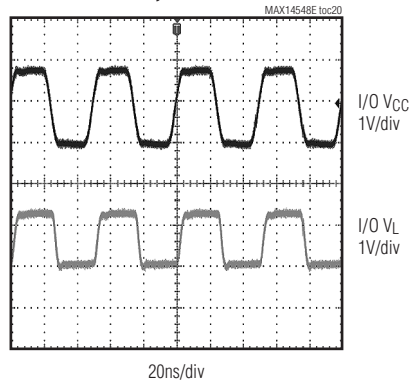

# 100Mbps, 16-Channel LLTs

## Pin Configuration

**MAX14548E/MAX14548AE**

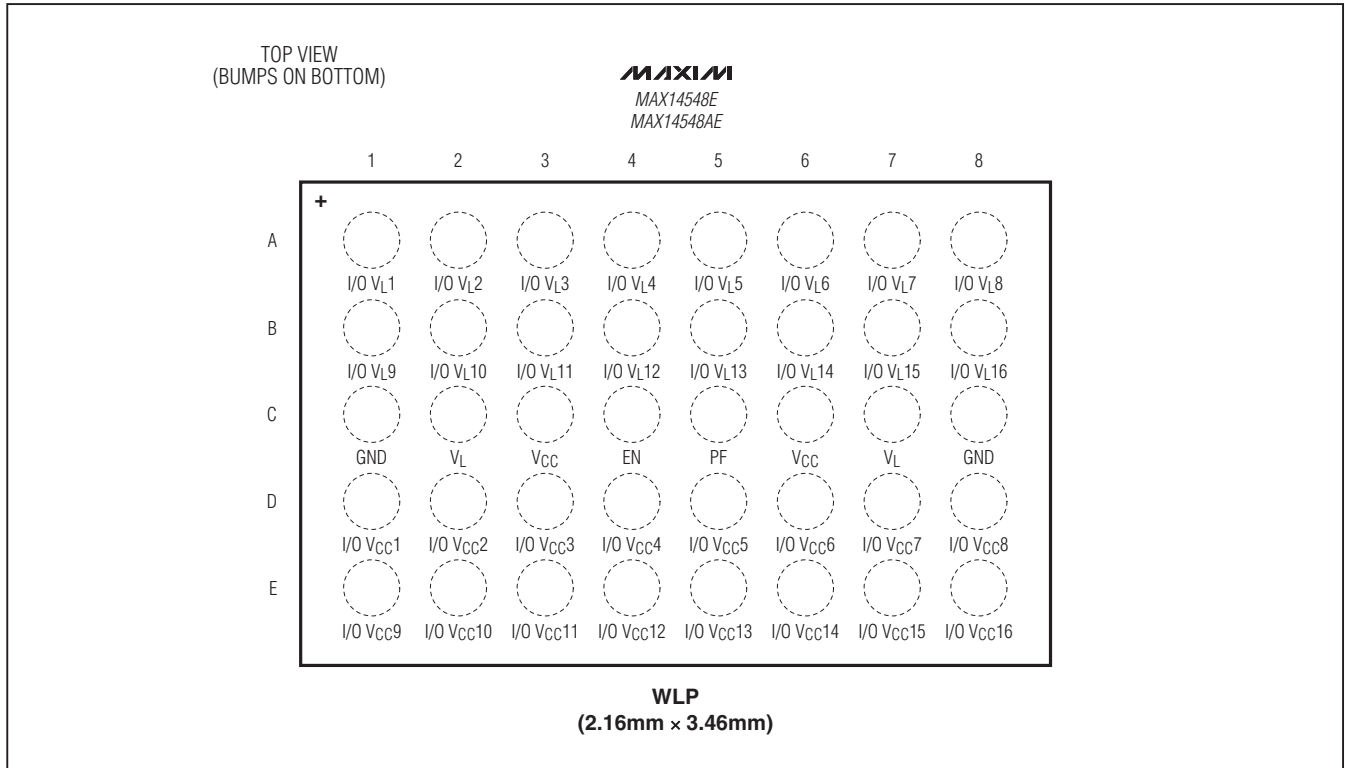

## Pin Description

PIN	NAME	FUNCTION
A1	I/O V <sub>L</sub> 1	Input/Output 1. Referenced to V <sub>L</sub> .
A2	I/O V <sub>L</sub> 2	Input/Output 2. Referenced to V <sub>L</sub> .
A3	I/O V <sub>L</sub> 3	Input/Output 3. Referenced to V <sub>L</sub> .
A4	I/O V <sub>L</sub> 4	Input/Output 4. Referenced to V <sub>L</sub> .
A5	I/O V <sub>L</sub> 5	Input/Output 5. Referenced to V <sub>L</sub> .
A6	I/O V <sub>L</sub> 6	Input/Output 6. Referenced to V <sub>L</sub> .
A7	I/O V <sub>L</sub> 7	Input/Output 7. Referenced to V <sub>L</sub> .
A8	I/O V <sub>L</sub> 8	Input/Output 8. Referenced to V <sub>L</sub> .
B1	I/O V <sub>L</sub> 9	Input/Output 9. Referenced to V <sub>L</sub> .
B2	I/O V <sub>L</sub> 10	Input/Output 10. Referenced to V <sub>L</sub> .
B3	I/O V <sub>L</sub> 11	Input/Output 11. Referenced to V <sub>L</sub> .
B4	I/O V <sub>L</sub> 12	Input/Output 12. Referenced to V <sub>L</sub> .
B5	I/O V <sub>L</sub> 13	Input/Output 13. Referenced to V <sub>L</sub> .
B6	I/O V <sub>L</sub> 14	Input/Output 14. Referenced to V <sub>L</sub> .
B7	I/O V <sub>L</sub> 15	Input/Output 15. Referenced to V <sub>L</sub> .
B8	I/O V <sub>L</sub> 16	Input/Output 16. Referenced to V <sub>L</sub> .
C1, C8	GND	Ground

# 100Mbps, 16-Channel LLTs

## Pin Description (continued)

PIN	NAME	FUNCTION
C2, C7	V <sub>L</sub>	Logic Supply Voltage, +1.1V to +3.6V. Bypass V <sub>L</sub> to GND with a 1μF capacitor placed as close as possible to the device.
C3, C6	V <sub>CC</sub>	Power-Supply Voltage, +1.7V to +3.6V. Bypass V <sub>CC</sub> to GND with a 0.1μF ceramic capacitor. For full ESD protection, connect an additional 1μF ceramic capacitor from V <sub>CC</sub> to GND as close as possible to the V <sub>CC</sub> input.
C4	EN	Enable Input. Drive EN to GND for shutdown mode, or drive EN to V <sub>L</sub> or V <sub>CC</sub> for normal operation.
C5	PF	Programmable Frequency Input. Drive PF low for high-frequency operation. Drive PF high for lower frequency operation.
D1	I/O V <sub>CC</sub> 1	Input/Output 1. Referenced to V <sub>CC</sub> .
D2	I/O V <sub>CC</sub> 2	Input/Output 2. Referenced to V <sub>CC</sub> .
D3	I/O V <sub>CC</sub> 3	Input/Output 3. Referenced to V <sub>CC</sub> .
D4	I/O V <sub>CC</sub> 4	Input/Output 4. Referenced to V <sub>CC</sub> .
D5	I/O V <sub>CC</sub> 5	Input/Output 5. Referenced to V <sub>CC</sub> .
D6	I/O V <sub>CC</sub> 6	Input/Output 6. Referenced to V <sub>CC</sub> .
D7	I/O V <sub>CC</sub> 7	Input/Output 7. Referenced to V <sub>CC</sub> .
D8	I/O V <sub>CC</sub> 8	Input/Output 8. Referenced to V <sub>CC</sub> .
E1	I/O V <sub>CC</sub> 9	Input/Output 9. Referenced to V <sub>CC</sub> .
E2	I/O V <sub>CC</sub> 10	Input/Output 10. Referenced to V <sub>CC</sub> .
E3	I/O V <sub>CC</sub> 11	Input/Output 11. Referenced to V <sub>CC</sub> .
E4	I/O V <sub>CC</sub> 12	Input/Output 12. Referenced to V <sub>CC</sub> .
E5	I/O V <sub>CC</sub> 13	Input/Output 13. Referenced to V <sub>CC</sub> .
E6	I/O V <sub>CC</sub> 14	Input/Output 14. Referenced to V <sub>CC</sub> .
E7	I/O V <sub>CC</sub> 15	Input/Output 15. Referenced to V <sub>CC</sub> .
E8	I/O V <sub>CC</sub> 16	Input/Output 16. Referenced to V <sub>CC</sub> .

# 100Mbps, 16-Channel LLTs

## Functional Diagram

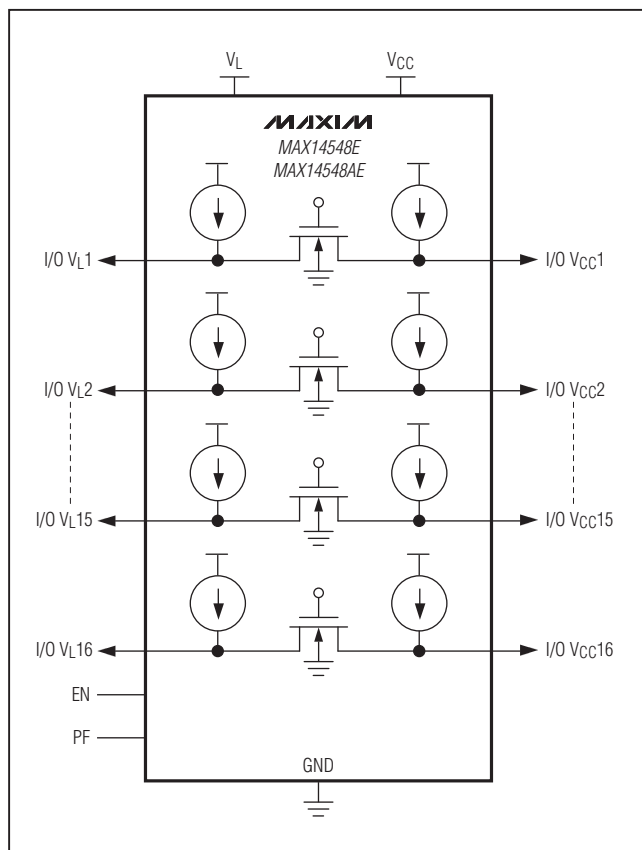

## Detailed Description

The MAX14548E/MAX14548AE 16-channel, bidirectional level translators (LLTs) provide the level shifting necessary for 100Mbps data transfer in multivoltage systems. Externally applied voltages,  $V_{CC}$  and  $V_L$ , set the logic levels on either side of the device. Logic signals present on the  $V_L$  side of the device appear as a high-voltage logic signal on the  $V_{CC}$  side of the device and vice versa.

The devices operate at full speed with external drivers that source as little as 4mA output current (min). Each I/O channel is pulled up to  $V_{CC}$  or  $V_L$  by an internal 35 $\mu$ A current source, allowing the devices to be driven by either push-pull or open-drain drivers.

The devices feature an enable input (EN) that places the device into a low-power shutdown mode when driven low. They also feature an automatic shutdown mode that disables the part when  $V_{CC}$  is less than  $V_L$ .

The devices feature a programmable frequency input (PF) that guarantees a bit rate of 100Mbps with a load capacitance < 15pF and  $V_L > 1.1V$  (MAX14548E) or  $V_L > 1.4V$  (MAX14548AE) when driven low. The MAX14548E can drive capacitive loads up to 50pF with a guaranteed bit rate of 40Mbps when  $V_L \geq 1.1V$  and PF is driven high. The MAX14548AE can drive capacitive loads up to 50pF with a guaranteed bit rate of 40Mbps when  $V_L \geq 1.1V$  and PF is driven high.

### Level Translation

For proper operation, ensure that  $1.7V \leq V_{CC} \leq 3.6V$ ,  $1.1V \leq V_L \leq V_{CC}$ . When power is supplied to  $V_L$  while  $V_{CC}$  is less than  $V_L$ , the devices automatically enter a low-power mode and the I/Os are in high-impedance mode. The devices also enter shutdown mode when  $EN = 0$ . In both conditions where  $EN = 0$  or  $V_L > V_{CC}$ , there is a known high-impedance state on I/O  $V_L$  and I/O  $V_{CC}$ . The maximum data rate depends heavily on the load capacitance (see the rise/fall time graphs in the *Typical Operating Characteristics*), output impedance of the driver, and the operating voltage range.

### Input Driver Requirements

The device architecture is based on an nMOS pass gate and output accelerator stages (Figure 4). The accelerators are active only when there is a rising/falling edge on a given I/O. A short pulse is then generated where the output accelerator stages become active and charge/discharge the capacitances at the I/Os. Due to its architecture, both input stages become active during the one-shot pulse. This can lead to some current feeding into the external source that is driving the translator. However, this behavior helps speed up the transition on the driven side.

The devices have internal current sources capable of sourcing 35 $\mu$ A to pull up the I/O lines. These internal pullup current sources allow the inputs to be driven with open-drain drivers and push-pull drivers. It is not recommended to use external pullup resistors on the I/O lines. The architecture of the devices permit either side to be driven with a minimum of 4mA drivers or larger.

### Output Load Requirements

The device I/Os are designed to drive CMOS inputs. Do not load the I/O lines with a resistive load less than 25k $\Omega$  and do not place an RC circuit at the input of these devices to slow down the edges. If a slower rise/fall time is required, refer to the MAX3000E/MAX3001E/MAX3002–MAX3012 data sheet.

## 100Mbps, 16-Channel LLTs

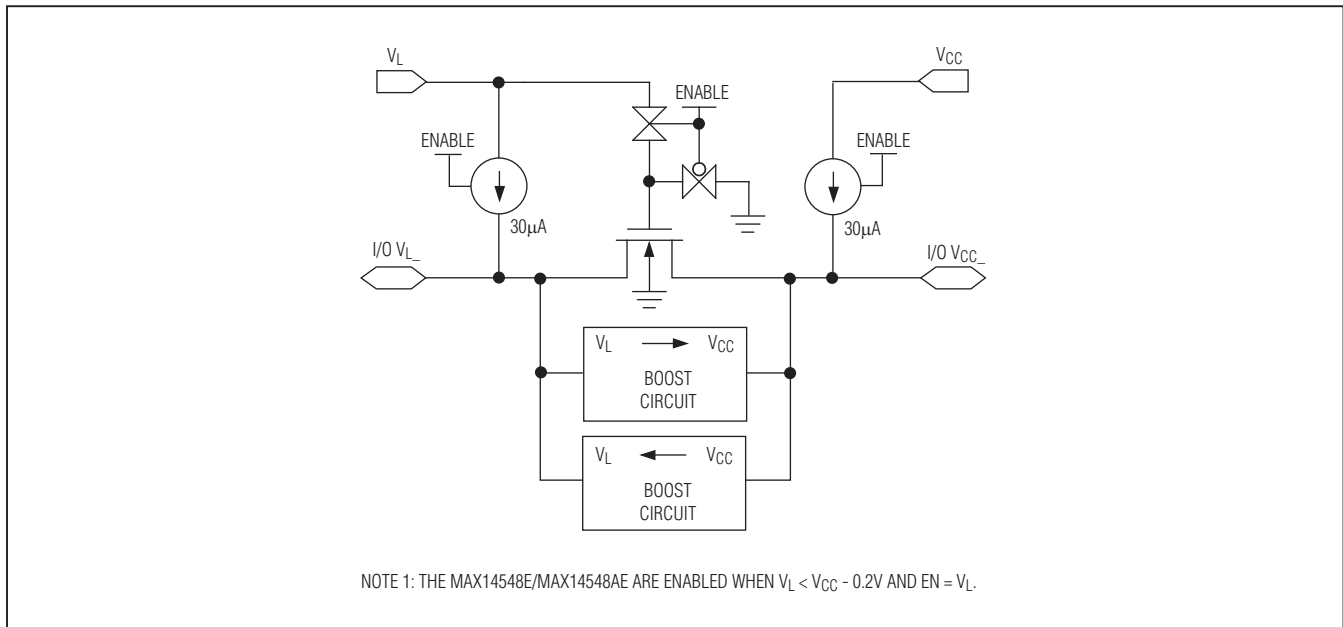

Figure 4. Simplified Functional Diagram for One I/O Line

### Shutdown Mode

The EN input places the devices into a low-power shutdown mode when driven low. The automatic shutdown mode disables the devices when  $V_{CC}$  is unconnected or less than  $V_L$ . When  $V_{CC}$  is less than  $V_L$  or  $EN = GND$ , the devices enter shutdown mode.

### Data Rate and Capacitive Load (PF Input)

The programmable frequency input (PF) adjusts the one-shot accelerator to guarantee a 100Mbps bit rate with a load capacitance  $< 15pF$  and  $V_L > 1.1V$  (MAX14548E) or  $V_L > 1.4V$  (MAX14548AE) when driven low. The MAX14548E can drive capacitive loads up to 50pF with a guaranteed 40Mbps bit rate when  $V_L > 1.1V$  and PF is driven high. The MAX14548AE can drive capacitive loads up to 50pF with a guaranteed 40Mbps bit rate when  $V_L > 1.1V$  and PF is driven high.

## Applications Information

### Layout Recommendations

Use standard high-speed layout practices when laying out a board with the MAX14548E/MAX14548AE. For example, to minimize line coupling, place all other signal lines not connected to the devices at least 1x the substrate height of the PCB away from the input and output lines of the devices.

### Power-Supply Decoupling

To reduce ripple and the chance of introducing data errors, bypass  $V_L$  and  $V_{CC}$  to ground with 0.1µF ceramic capacitors. Place all capacitors as close as possible to the power-supply inputs. For full ESD protection, bypass  $V_{CC}$  with a 1µF ceramic capacitor located as close as possible to the  $V_{CC}$  input.

## 100Mbps, 16-Channel LLTs

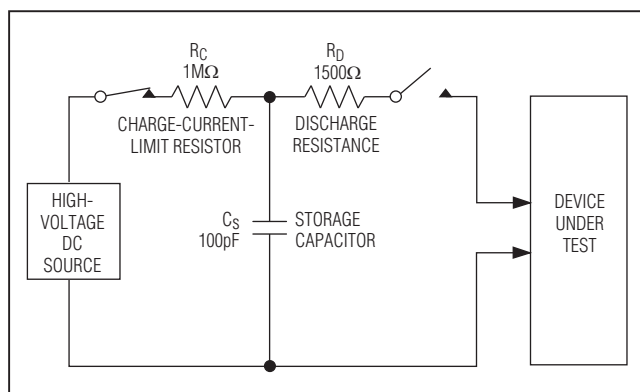

Figure 5a. Human Body ESD Test Model

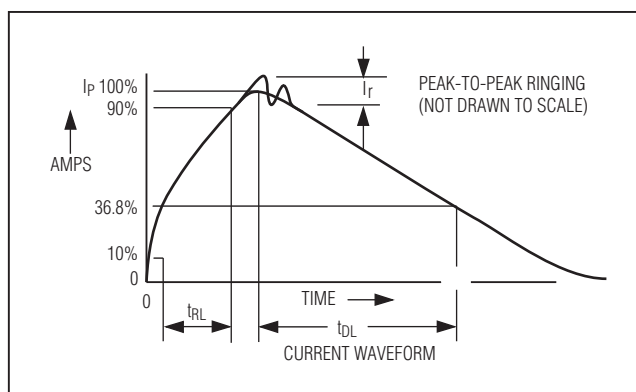

Figure 5b. Human Body Current Waveform

### Unidirectional vs. Bidirectional Level Translator

The devices bidirectional level translators can operate as a unidirectional device by selecting one I/O as the input and the corresponding I/O as an output. These devices provide the smallest solution (WLP package) for level translation applications.

### ESD Protection

As with all Maxim devices, ESD-protection structures are incorporated on all pins to protect against electrostatic discharges encountered during handling and assembly. The I/O  $V_{L\_}$  and I/O  $V_{CC\_}$  pins have extra protection against static electricity.

### ESD Test Conditions

ESD performance depends on a variety of conditions. Contact Maxim for a reliability report that documents test setup, test methodology, and test results.

### Human Body Model

Figure 5a shows the Human Body Model, and Figure 5b shows the current waveform it generates when discharged into a low impedance. This model consists of a 100pF capacitor charged to the ESD voltage of interest, which is then discharged into the test device through a 1.5kΩ resistor.

### Use with External Pullup/Pulldown Resistors

Due to the architecture of the devices, it is not recommended to use external pullup or pulldown resistors on the bus. In certain applications, the use of external pullup or pulldown resistors is desired to have a known bus state when there is no active driver on the bus. The devices include internal pullup current sources that set the bus state when the device is enabled. In shutdown mode, the state of I/O  $V_{CC\_}$  and I/O  $V_{L\_}$  is high impedance.

### Open-Drain Signaling

The devices are designed to pass open-drain as well as CMOS push-pull signals. When used with open-drain signaling, the rise time is dominated by the interaction of the internal pullup current source and the parasitic load capacitance. The devices include internal rise time accelerators to speed up transitions, eliminating any need for external pullup resistors. For applications such as I<sup>2</sup>C or 1-Wire<sup>®</sup> that require an external pullup resistor, refer to the MAX13046E and MAX13047E data sheets.

1-Wire is a registered trademark of Maxim Integrated Products, Inc.

# 100Mbps, 16-Channel LLTs

## Typical Operating Circuit

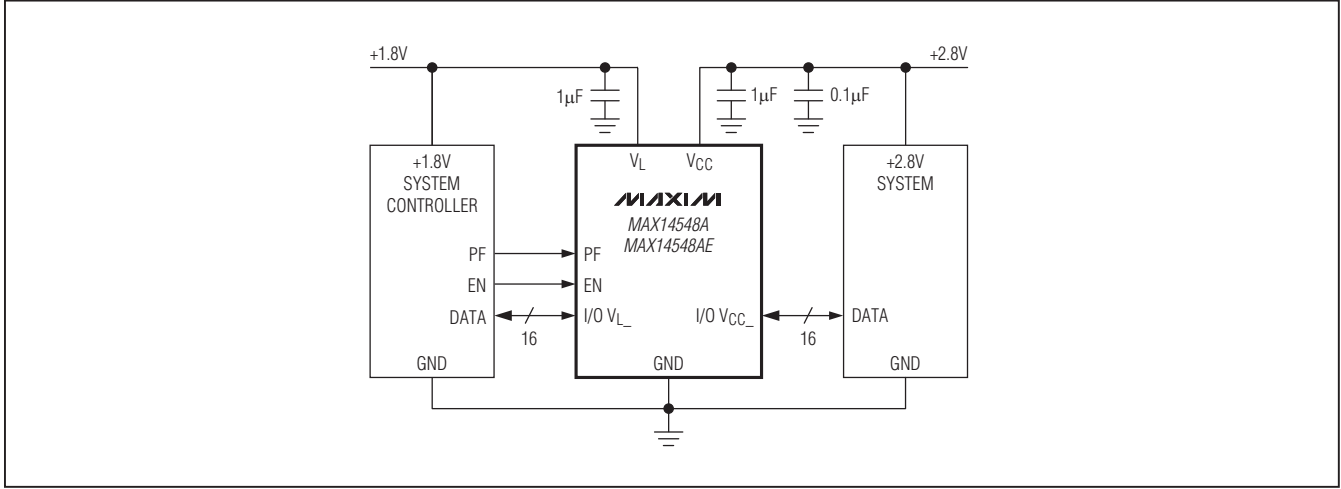

### Chip Information

PROCESS: BiCMOS

### Package Information

For the latest package outline information and land patterns, go to [www.maxim-ic.com/packages](http://www.maxim-ic.com/packages). Note that a "+", "#", or "-" in the package code indicates RoHS status only. Package drawings may show a different suffix character, but the drawing pertains to the package regardless of RoHS status.

PACKAGE TYPE	PACKAGE CODE	DOCUMENT NO.
40 WLP	W402B3+1	<a href="#">21-0437</a>



# 100Mbps, 16-Channel LLTs

## Revision History

REVISION NUMBER	REVISION DATE	DESCRIPTION	PAGES CHANGED
0	4/10	Initial release	—

**MAX14548E/MAX14548AE**

*Maxim cannot assume responsibility for use of any circuitry other than circuitry entirely embodied in a Maxim product. No circuit patent licenses are implied. Maxim reserves the right to change the circuitry and specifications without notice at any time.*

**Maxim Integrated Products, 120 San Gabriel Drive, Sunnyvale, CA 94086 408-737-7600** \_\_\_\_\_ **17**