



SMBus-Compatible Temperature Monitor with Automatic PWM Fan-Speed Controller

MAX6641

General Description

The MAX6641 temperature sensor and fan controller accurately measures the temperature of its own die and the temperature of a remote pn junction. The device reports temperature values in digital form using a 2-wire serial interface. The remote pn junction is typically the emitter-base junction of a common-collector pnp on a CPU, FPGA, or ASIC.

The 2-wire serial interface accepts standard System Management Bus (SMBus)TM write byte, read byte, send byte, and receive byte commands to read the temperature data and program the alarm thresholds. The temperature data controls a PWM output signal to adjust the speed of a cooling fan, thereby minimizing noise when the system is running cool, but providing maximum cooling when power dissipation increases. The device also features an over-temperature alarm output to generate interrupts, throttle signals, or shut down signals. The MAX6641 operates from supply voltages in the 3.0V to 5.5V range and typically consumes 500 μ A of supply current.

The MAX6641 is available in a slim 10-pin μ MAX[®] package and is available over the -40°C to +125°C automotive temperature range.

Applications

Desktop Computers
 Notebook Computers
 Workstations
 Servers
 Networking Equipment
 Industrial

Typical Application Circuit appears at end of data sheet.

μ MAX is a registered trademark of Maxim Integrated Products, Inc.
 SMBus is a trademark of Intel Corp.

Features

- ◆ Tiny 3mm x 5mm μ MAX Package
- ◆ Thermal Diode Input
- ◆ Local Temperature Sensor
- ◆ Open-Drain PWM Output for Fan Drive
- ◆ Programmable Fan Control Characteristics
- ◆ Automatic Fan Spin-Up Ensures Fan Start
- ◆ $\pm 1^\circ\text{C}$ Remote Temperature Accuracy (+60°C to +145°C)
- ◆ Controlled Rate of Change Ensures Unobtrusive Fan-Speed Adjustments
- ◆ Temperature Monitoring Begins at Power-On for Fail-Safe System Protection
- ◆ $\overline{\text{OT}}$ Output for Throttling or Shutdown

Ordering Information

PART	PIN-PACKAGE	SMBus ADDRESS	PKG CODE
MAX6641AUB90	10 μ MAX	1001 000x	U10-2
MAX6641AUB92	10 μ MAX	1001 001x	U10-2
MAX6641AUB94	10 μ MAX	1001 010x	U10-2
MAX6641AUB96	10 μ MAX	1001 011x	U10-2

Note: All devices are specified over the -40°C to +125°C temperature range.

Pin Configuration



SMBus-Compatible Temperature Monitor with Automatic PWM Fan-Speed Controller

ABSOLUTE MAXIMUM RATINGS

(All voltages referenced to GND.)

V _{CC} , $\overline{\text{OT}}$, SMBDATA, SMBCLK, PWMOUT	-0.3V to +6V
DXP	-0.3V to (V _{CC} + 0.3V)
DXN	-0.3V to +0.8V
ESD Protection (all pins, Human Body Model)	±2000V

Continuous Power Dissipation (T_A = +70°C)

10-Pin μ MAX (derate 5.6mW/°C above +70°C)	444mW
Operating Temperature Range	-40°C to +125°C
Junction Temperature	+150°C
Storage Temperature Range	-65°C to +150°C
Lead Temperature (soldering, 10s)	+300°C

Stresses beyond those listed under "Absolute Maximum Ratings" may cause permanent damage to the device. These are stress ratings only, and functional operation of the device at these or any other conditions beyond those indicated in the operational sections of the specifications is not implied. Exposure to absolute maximum rating conditions for extended periods may affect device reliability.

ELECTRICAL CHARACTERISTICS

(V_{CC} = +3.0V to +5.5V, T_A = 0°C to +125°C, unless otherwise noted. Typical values are at V_{CC} = 3.3V, T_A = +25°C.)

PARAMETER	SYMBOL	CONDITIONS	MIN	TYP	MAX	UNITS
Operating Supply Voltage Range	V _{CC}		3.0		5.5	V
Operating Current		SMBDATA, SMBCLK not switching		0.5	1	mA
External Temperature Error	V _{CC} = 3.3V	+25°C ≤ T _R ≤ +125°C, T _A = +60°C			±1	°C
		0°C ≤ T _R ≤ +145°C, +25°C ≤ T _A ≤ +100°C			±3	
		0°C ≤ T _R ≤ +145°C, 0°C ≤ T _A ≤ +125°C			±4	
Internal Temperature Error	V _{CC} = 3.3V	+25°C ≤ T _A ≤ +100°C	-3		+3	°C
		0°C ≤ T _A ≤ +125°C	-4		+4	
Temperature Resolution			1			°C
			8			Bits
Conversion Time			200	250	300	ms
PWM Frequency Tolerance			-20		+20	%
Remote-Diode Sourcing Current		High level	80	100	120	μA
		Low level	8	10	12	
DXN Source Voltage				0.7		V
I/O						
$\overline{\text{OT}}$, SMBDATA, PWMOUT Output Low Voltage	V _{OL}	I _{OUT} = 6mA			0.4	V
$\overline{\text{OT}}$, SMBDATA, PWMOUT Output-High Leakage Current	I _{OH}	V _{CC} = 5.5V			1	μA
SMBDATA, SMBCLK Logic-Low Input Voltage	V _{IL}	V _{CC} = 3V to 5.5V			0.8	V
SMBDATA, SMBCLK Logic-High Input Voltage	V _{IH}	V _{CC} = 3V to 5.5V	2.1			V
SMBDATA, SMBCLK Leakage Current					1	μA
SMBDATA, SMBCLK Input Capacitance	C _{IN}			5		pF

SMBus-Compatible Temperature Monitor with Automatic PWM Fan-Speed Controller

MAX6641

ELECTRICAL CHARACTERISTICS (continued)

($V_{CC} = +3.0V$ to $+5.5V$, $T_A = 0^\circ C$ to $+125^\circ C$, unless otherwise noted. Typical values are at $V_{CC} = 3.3V$, $T_A = +25^\circ C$.)

PARAMETER	SYMBOL	CONDITIONS	MIN	TYP	MAX	UNITS
SMBus-COMPATIBLE TIMING (Note 1) (See Figures 2, 3)						
Serial-Clock Frequency	f _{SCLK}	(Note 2)			100	kHz
Clock Low Period	t _{LOW}	10% to 10%	4			μs
Clock High Period	t _{HIGH}	90% to 90%	4.7			μs
Bus Free Time Between Stop and Start Condition	t _{BUF}		4.7			μs
Hold Time After (Repeated) Start Condition	t _{HD:STA}		4			μs
SMBus Start Condition Setup Time	t _{SU:STA}	90% of SMBCLK to 90% of SMBDATA	4.7			μs
Start Condition Hold Time	t _{HD:STO}	10% of SMBDATA to 10% of SMBCLK	4			μs
Stop Condition Setup Time	t _{SU:STO}	90% of SMBCLK to 10% of SMBDATA	4			μs
Data Setup Time	t _{SU:DAT}	10% of SMBDATA to 10% of SMBCLK	250			ns
Data Hold Time	t _{HD:DAT}	10% of SMBCLK to 10% of SMBDATA (Note 3)	300			ns
SMBus Fall Time	t _F				300	ns
SMBus Rise Time	t _R				1000	ns
SMBus Timeout	t _{TIMEOUT}		29	37	55	ms
Startup Time After POR	t _{POR}				500	ms

Note 1: Timing specifications guaranteed by design.

Note 2: The serial interface resets when SMBCLK is low for more than t_{TIMEOUT}.

Note 3: A transition must internally provide at least a hold time to bridge the undefined region (300ns max) of SMBCLK's falling edge.

Typical Operating Characteristics

($V_{CC} = 3.3V$, $T_A = +25^\circ C$, unless otherwise noted.)

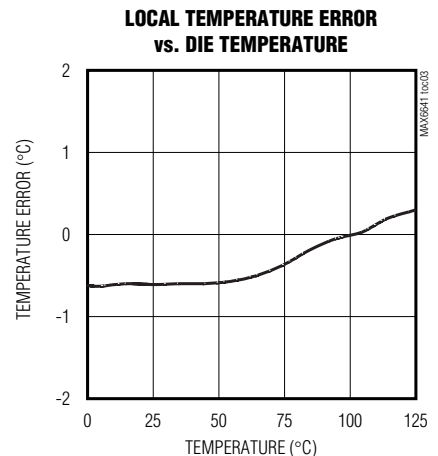
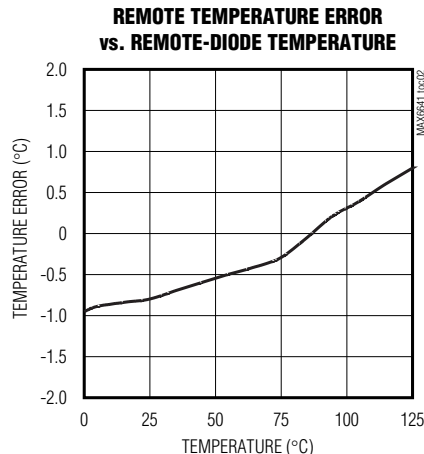
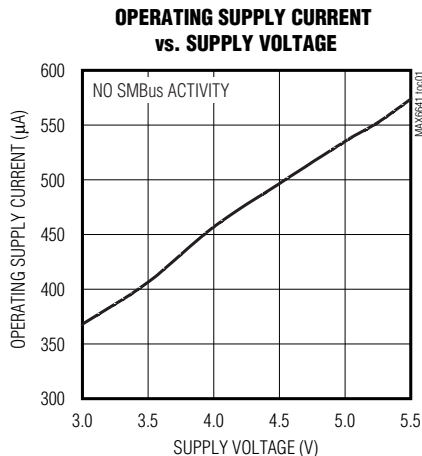

SMBus-Compatible Temperature Monitor with Automatic PWM Fan-Speed Controller

Typical Operating Characteristics (continued)

($V_{CC} = 3.3V$, $T_A = +25^\circ C$, unless otherwise noted.)

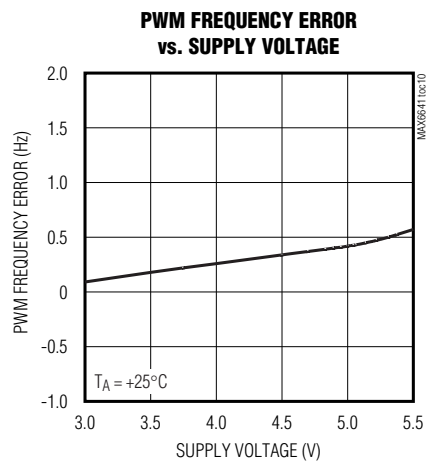
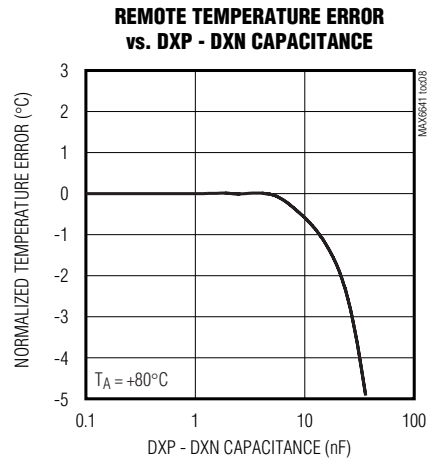
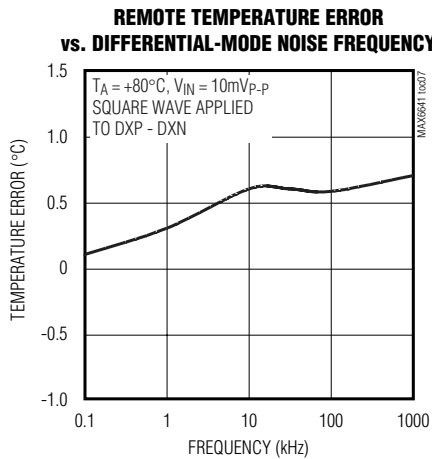
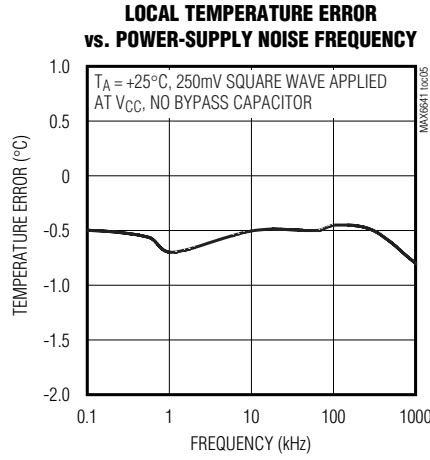

SMBus-Compatible Temperature Monitor with Automatic PWM Fan-Speed Controller

MAX6641

Pin Description

PIN	NAME	FUNCTION
1, 6	I.C.	Internally Connected. Must be connected to GND.
2	DXN	Combined Remote-Diode Cathode Connection and A/D Negative Input. Connect the cathode of the remote-diode-connected transistor to DXN.
3	DXP	Combined Remote-Diode Current Source and A/D Positive Input for Remote-Diode Channel. Connect DXP to the anode of a remote-diode-connected temperature-sensing transistor. DO NOT LEAVE DXP FLOATING ; connect to DXN if no remote diode is used. Place a 2200pF capacitor between DXP and DXN for noise filtering.
4	GND	Ground
5	\overline{OT}	Active-Low, Open-Drain, Over-Temperature Output. Use \overline{OT} as an interrupt, a system shutdown signal, or to control clock throttling. \overline{OT} can be pulled up to 5.5V, regardless of the voltage on V_{CC} . \overline{OT} is high impedance when $V_{CC} = 0$.
7	SMBCLK	SMBus Serial-Clock Input. SMBCLK can be pulled up to 5.5V, regardless of V_{CC} . Open drain. SMBCLK is high impedance when $V_{CC} = 0$.
8	SMBDATA	SMBus Serial-Data Input/Output. SMBDATA can be pulled up to 5.5V, regardless of V_{CC} . Open drain. SMBDATA is high impedance when $V_{CC} = 0$.
9	V_{CC}	Positive Supply. Bypass with a 0.1 μ F capacitor to GND.
10	PWMOUT	PWM Output to Fan Power Transistor. Connect PWMOUT to the gate of a MOSFET or the base of a bipolar transistor to drive the fan's power supply with a PWM waveform. Alternatively, the PWM output can be connected to the PWM input of a fan with direct speed-control capability, or it can be converted to a DC voltage for driving the fan's power supply. PWMOUT requires a pullup resistor. The pullup resistor can be connected to a voltage supply up to 5.5V, regardless of V_{CC} .

Detailed Description

The MAX6641 temperature sensor and fan controller accurately measures the temperature of its own die and the temperature of a remote pn junction. The device reports temperature values in digital form using a 2-wire serial interface. The remote pn junction is typically the emitter-base junction of a common-collector pnp on a CPU, FPGA, or ASIC. The MAX6641 operates from supply voltages of 3.0V to 5.5V and consumes 500 μ A of supply current. The temperature data controls a PWM output signal to adjust the speed of a cooling fan. The device also features an over-temperature alarm output to generate interrupts, throttle signals, or shut down signals.

SMBus Digital Interface

From a software perspective, the MAX6641 appears as a set of byte-wide registers that contain temperature data, alarm threshold values, and control bits. A standard SMBus-compatible 2-wire serial interface is used to read temperature data and write control bits and alarm threshold data. These devices respond to the same SMBus slave address for access to all functions.

The MAX6641 employs four standard SMBus protocols: write byte, read byte, send byte, and receive byte (Figures 1, 2, and 3). The shorter receive byte protocol allows quicker transfers, provided that the correct data register was previously selected by a read byte instruction. Use caution when using the shorter protocols in multimaster systems, as a second master could overwrite the command byte without informing the first master. The MAX6641 has four different slave addresses available; therefore, a maximum of four MAX6641 devices can share the same bus.

Temperature data within the 0°C to +255°C range can be read from the read external temperature register (00h). Temperature data within the 0°C to +125°C range can be read from the read internal temperature register (01h). The temperature data format for these registers is 8 bits, with the LSB representing +1°C (Table 1) and the MSB representing +128°C. The MSB is transmitted first. All values below 0°C are clipped to 00h.

Table 1 details the register address and function, whether they can be read or written to, and the power-on reset (POR) state. See Tables 1–5 for all other register functions and the *Register Descriptions* section. Figure 4 is the MAX6641 block diagram.

SMBus-Compatible Temperature Monitor with Automatic PWM Fan-Speed Controller

Table 1. Register Functions

READ/ WRITE	REGISTER ADDRESS	POR STATE	FUNCTION/ NAME	D7	D6	D5	D4	D3	D2	D1	D0
R	00h	0000 0000	Read remote (external) temperature	MSB (+128°C)	(+64°C)	(+32°C)	(+16°C)	(+8°C)	(+4°C)	(+2°C)	LSB (+1°C)
R	01h	0000 0000	Read local (internal) temperature	MSB (+128°C)	(+64°C)	(+32°C)	(+16°C)	(+8°C)	(+4°C)	(+2°C)	LSB (+1°C)
R/W	02h	0000 00xx	Configuration byte	Reserved set to 0	Reserved set to 0	Timeout: 0 = enabled, 1 = disabled	Fan PWM invert	Min duty cycle: 0 = 0%, 1 = fan-start duty cycle	Spin-up disable	X	X
R/W	03h	0110 1110	Remote-diode temperature \overline{OT} limit	MSB (+128°C)	(+64°C)	(+32°C)	(+16°C)	(+8°C)	(+4°C)	(+2°C)	LSB (+1°C)
R/W	04h	0101 0000	Local-diode temperature \overline{OT} limit	MSB (+128°C)	(+64°C)	(+32°C)	(+16°C)	(+8°C)	(+4°C)	(+2°C)	LSB (+1°C)
R	05h	00xx xxxx	\overline{OT} status	Remote 1 = fault	Local 1 = fault	X	X	X	X	X	X
R/W	06h	00xx xxxx	\overline{OT} mask	Remote 1 = masked	Local 1 = masked	X	X	X	X	X	X
R/W	07h	0110 000x (96 = 40%)	Fan-start duty cycle	MSB (128/240)	(64/240)	(32/240)	(16/240)	(8/240)	(4/240)	LSB (2/240)	X
R/W	08h	1111 000x (240 = 100%)	Fan maximum duty cycle	MSB (128/240)	(64/240)	(32/240)	(16/240)	(8/240)	(4/240)	LSB (2/240)	X
R/W	09h	0000 000x	Fan target duty cycle	MSB (128/240)	(64/240)	(32/240)	(16/240)	(8/240)	(4/240)	LSB (2/240)	X
R	0Ah	0000 000x	Fan instantaneous duty cycle	MSB (128/240)	(64/240)	(32/240)	(16/240)	(8/240)	(4/240)	LSB (2/240)	X
R/W	0Bh	0000 0000	Remote-diode fan-start temperature	MSB (+128°C)	(+64°C)	(+32°C)	(+16°C)	(+8°C)	(+4°C)	(+2°C)	LSB (+1°C)

SMBus-Compatible Temperature Monitor with Automatic PWM Fan-Speed Controller

MAX6641

Table 1. Register Functions (continued)

READ/ WRITE	REGISTER ADDRESS	POR STATE	FUNCTION/ NAME	D7	D6	D5	D4	D3	D2	D1	D0
R/W	0Ch	0000 0000	Local-diode fan-start temperature	MSB (+128°C)	(+64°C)	(+32°C)	(+16°C)	(+8°C)	(+4°C)	(+2°C)	LSB (+1°C)
R/W	0Dh	0000 xxxx	Fan configuration	Hysteresis: 0 = 5°C, 1 = 10°C	Temp step: 0 = 1°C, 1 = 2°C	Fan control: 1 = remote	Fan control: 1 = local	X	X	X	X
R/W	0Eh	101x xxxx	Duty-cycle rate of change	MSB	—	LSB	X	X	X	X	X
R/W	0Fh	0101 xxxx	Duty-cycle step size	MSB	—	—	LSB	X	X	X	X
R/W	10h	010x xxxx	PWM frequency select	Select A	Select B	Select C	X	X	X	X	X
R	FDh	0000 0001	Read device revision	0	0	0	0	0	0	0	1
R	FEh	1000 0111	Read device ID	1	0	0	0	0	1	1	1
R	FFh	0100 1101	Read manufacturer ID	0	1	0	0	1	1	0	1

X = Don't care. See register descriptions for further details.

SMBus-Compatible Temperature Monitor with Automatic PWM Fan-Speed Controller



Figure 1. SMBus Protocols



Figure 2. SMBus Write Timing Diagram

SMBus-Compatible Temperature Monitor with Automatic PWM Fan-Speed Controller



Figure 3. SMBus Read Timing Diagram



Figure 4. Block Diagram

Register Descriptions

Temperature Registers (00h, 01h)

These registers contain the 8-bit results of the temperature measurements. Register 00h contains the temperature reading of the remote diode. Register 01h contains the ambient temperature reading. The value of the MSB

is +128°C and the value of the LSB is +1°C. The MSB is transmitted first. The POR state of the temperature registers is 00h.

Configuration Byte Register (02h)

The configuration byte register controls the timeout conditions and various PWMOUT signals. The POR state of the configuration byte register is 00h. See Table 2 for configuration byte definitions.

Remote and Local \overline{OT} Limits (03h, 04h)

Set the remote (03h) and local (04h) temperature thresholds with these two registers. Once the temperature is above the threshold, the \overline{OT} output is asserted low (for the temperature channels that are not masked). The POR state of the remote \overline{OT} limit register is 6Eh and the POR state of the LOCAL \overline{OT} limit register is 50h.

\overline{OT} Status (05h)

Read the \overline{OT} status register to determine which channel recorded an over-temperature condition. Bit D7 is high if the fault reading occurred from the remote diode. Bit D6 is high if the fault reading occurred in the local diode. The \overline{OT} status register is cleared only by reading its contents. Reading the contents of the register also makes the \overline{OT} output high impedance. If the fault is still present on the next temperature measurement cycle, the corresponding bits and the \overline{OT} output are set again. After reading the \overline{OT} status register, a temperature register read must be done to correctly clear the appropriate status bit. The POR state of the \overline{OT} status register is 00h.

SMBus-Compatible Temperature Monitor with Automatic PWM Fan-Speed Controller

Table 2. Configuration Byte Definition (02h)

BIT	NAME	POR STATE	FUNCTION
7	—	0	Reserved. Set to zero.
6	—	0	Reserved. Set to zero.
5	TIMEOUT	0	Set TIMEOUT to zero to enable SMBus timeout for prevention of bus lockup. Set to 1 to disable this function.
4	FAN PWM INVERT	0	Set FAN PWM INVERT to zero to force PWMOUT low when the duty cycle is 100%. Set to 1 to force PWMOUT high when the duty cycle is 100%.
3	MIN DUTY CYCLE	0	Set MIN DUTY CYCLE to zero for a 0% duty cycle when the measured temperature is below the fan-temperature threshold in automatic mode. When the temperature equals the fan-temperature threshold, the duty cycle is the value in the fan-start duty-cycle register, which increases with increasing temperature. Set MIN DUTY CYCLE to 1 to force the PWM duty cycle to the value in the fan-start duty-cycle register when the measured temperature is below the fan-temperature threshold. As the temperature increases above the temperature threshold, the duty cycle increases as programmed.
2	SPIN-UP DISABLE	0	Set SPIN-UP DISABLE to 1 to disable spin-up. Set to zero for normal fan spin-up.
1	—	X	Don't care.
0	—	X	Don't care.

\overline{OT} Mask (06h)

Set bit D7 to 1 in the \overline{OT} mask register to prevent the \overline{OT} output from asserting on faults in the remote-diode temperature channel. Set bit D6 to 1 to prevent the \overline{OT} output from asserting on faults in the local-diode temperature channel. The POR state of the \overline{OT} mask register is 00h.

Fan-Start Duty Cycle (07h)

The fan-start duty-cycle register determines the PWM duty cycle where the fan starts spinning. Bit D3 in the configuration byte register (MIN DUTY CYCLE) determines the starting duty cycle. If the MIN DUTY CYCLE bit is 1, the duty cycle is the value written to the fan-start duty-cycle register at all temperatures below the fan-start temperature. If the MIN DUTY CYCLE bit is zero, the duty cycle is zero below the fan-start temperature and has this value when the fan-start temperature is reached. A value of 240 represents 100% duty cycle. Writing any value greater than 240 causes the fan speed to be set to 100%. The POR state of the fan-start duty-cycle register is 60h, 40%.

Fan Maximum Duty Cycle (08h)

The fan maximum duty-cycle register sets the maximum allowable PWMOUT duty cycle between 2/240 (0.83% duty cycle) and 240/240 (100% duty cycle). Any values greater than 240 are recognized as 100% maximum duty cycle. The POR state of the fan maximum duty-cycle register is F0h, 100%. In manual control mode, this register is ignored.

Fan-Target Duty Cycle (09h)

In automatic fan-control mode, this register contains the present value of the target PWM duty cycle, as determined by the measured temperature and the duty-cycle step size. The actual duty cycle needs a settling time before it equals the target duty cycle if the duty-cycle rate of change register is set to a value other than zero. The actual duty cycle needs the time to settle as defined by the value of the duty-cycle rate-of-change register; therefore, the target duty cycle and the actual duty cycle are often different. In manual fan-control mode, write the desired value of the PWM duty cycle directly into this register. The POR state of the fan-target duty-cycle register is 00h.

SMBus-Compatible Temperature Monitor with Automatic PWM Fan-Speed Controller

MAX6641

Fan Instantaneous Duty Cycle (0Ah)

Read the fan instantaneous duty-cycle register to determine the duty cycle at PWMOUT at any time. The POR state of the fan instantaneous duty-cycle register is 00h.

Remote- and Local-Diode Fan-Start Temperature (0Bh, 0Ch)

These registers contain the temperature threshold values at which fan control begins in automatic mode. See the *Automatic PWM Duty-Cycle Control* section for details on setting the fan-start thresholds. The POR state of the remote- and local-diode fan-start temperature registers is 00h.

Fan Configuration (0Dh)

The fan-configuration register controls the hysteresis level, temperature step size, and whether the remote or local diode controls the PWMOUT signal; see Table 1. Set bit D7 of the fan-configuration register to zero to set the hysteresis value to 5°C. Set bit D7 to 1 to set the hysteresis value to 10°C. Set bit D6 to zero to set the fan-control temperature step size to 1°C. Set bit D6 to 1 to set the fan-control temperature step size to 2°C. Set bit D5 to 1 to control the fan with the remote-diode's temperature reading. Set bit D4 to 1 to control the fan with the local-diode's temperature reading. If both bits D5 and D4 are high, the device uses the highest PWM value. If both bits D5 and D4 are zero, the MAX6641 runs in manual fan-control mode where only the value written to the fan-target duty-cycle register (09h) controls the PWMOUT duty cycle. In manual fan-control mode, the value written to the fan-target duty-cycle register is not limited by the value in the maximum duty-cycle register. It is, however, clipped to 240 if a value above 240 is written. The POR state of the fan-configuration register is 00h.

Duty-Cycle Rate of Change (0Eh)

Bits D7, D6, and D5 of the duty-cycle rate-of-change register set the time between increments of the duty cycle. Each increment is 2/240 of the duty cycle; see Table 3. This allows the time from 33% to 100% duty cycle to be adjusted from 5s to 320s. The rate-of-change control is always active in manual mode. To make instant changes, set bits D7, D6, D5 = 000. The POR state of the duty-cycle rate-of-change register is A0h (1s time between increments).

Duty-Cycle Step Size (0Fh)

Bits D7–D4 of the duty-cycle step-size register change the size of the duty-cycle change for each temperature step. The POR state of the duty-cycle step-size register is 50h; see Table 4.

Table 3. Duty-Cycle Rate-of-Change Register (0Eh)

D7, D6, D5	TIME BETWEEN INCREMENTS (s)	TIME FROM 33% TO 100% (s)
000	0	0
001	0.0625	5
010	0.1250	10
011	0.2500	20
100	0.5000	40
101	1.0000	80
110	2.0000	160
111	4.0000	320

Table 4. Duty-Cycle Step-Size Register (0Fh)

D7–D4	CHANGE IN DUTY CYCLE PER TEMPERATURE STEP	TEMPERATURE RANGE FOR FAN CONTROL (1°C STEP, 33% TO 100%)
0000	0/240	N/A
0001	2/240	80.00
0010	4/240	40.00
0011	6/240	26.67
0100	8/240	20.00
0101	10/240	16.00
0110	12/240	13.33
0111	14/240	11.43
1000	16/240	10.00
1001	18/240	8.89
1010	20/240	8.00
1011	22/240	7.27
1100	24/240	6.67
1101	26/240	6.15
1110	28/240	5.71
1111	30/240	5.33

PWM Frequency Select (10h)

Set bits D7, D6, and D5 (select A, select B, and select C) in the PWM frequency-select register to control the PWMOUT frequency; see Table 5. The POR state of the PWM frequency select register is 40h, 33Hz. The lower frequencies are usually used when driving the fan's power-supply pin as in the *Typical Application Circuit*, with 33Hz being the most common choice. The 35kHz

SMBus-Compatible Temperature Monitor with Automatic PWM Fan-Speed Controller

Table 5. PWM Frequency Select (10h)

PWM FREQUENCY (Hz)	SELECT A	SELECT B	SELECT C
20	0	0	0
33	0	1	0
50	1	0	0
100	1	1	0
35k	X	X	1

frequency setting is used for controlling fans that have logic-level PWM input pins for speed control. Duty-cycle resolution is decreased from 2/240 to 4/240 at the 35kHz frequency setting.

PWM Output

The PWMOUT signal is normally used in one of three ways to control the fan's speed:

- 1) PWMOUT drives the gate of a MOSFET or the base of a bipolar transistor in series with the fan's power supply. The *Typical Application Circuit* shows the PWMOUT pin driving an n-channel MOSFET. In this case, the PWM invert bit (D4 in register 02h) is set to 1. Figure 5 shows PWMOUT driving a p-channel MOSFET and the PWM invert bit must be set to zero.
- 2) PWMOUT is converted (using an external circuit) into a DC voltage that is proportional to duty cycle. This duty-cycle-controlled voltage becomes the power supply for the fan. This approach is less efficient than 1), but can result in quieter fan operation. Figure 6 shows an example of a circuit that converts the PWM signal to a DC voltage. Because this circuit produces a full-scale output voltage when PWMOUT = 0V, bit D4 in register 02h should be set to zero.
- 3) PWMOUT directly drives the logic-level PWM speed-control input on a fan that has this type of input. This approach requires fewer external components and combines the efficiency of 1) with the low noise of 2). An example of PWMOUT driving a fan with a speed-control input is shown in Figure 7. Bit D4 in register 02h should be set to 1 when this configuration is used.

Whenever the fan has to start turning from a motionless state, PWMOUT is forced high for 2s. After this spin-up period, the PWMOUT duty cycle settles to the predetermined value. If spin-up is disabled (bit 2 in the configuration byte = 1), the duty cycle changes immediately from zero to the nominal value, ignoring the duty-cycle rate-of-change setting.



Figure 5. Driving a P-Channel MOSFET for Top-Side PWM Fan Drive



Figure 6. Driving a Fan with a PWM-to-DC Circuit

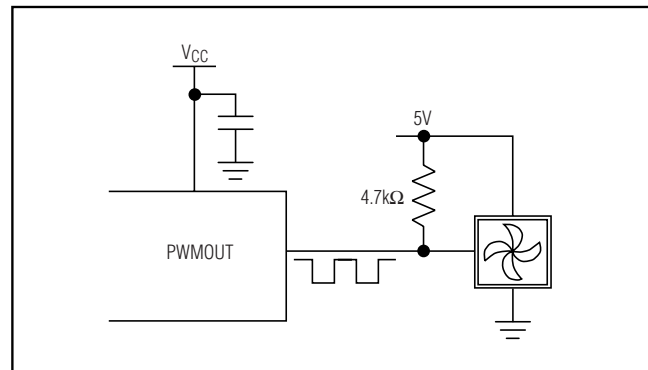

Figure 7. Controlling a PWM Input Fan with the MAX6641's PWM Output (Typically, the 35kHz PWM Frequency is Used)

SMBus-Compatible Temperature Monitor with Automatic PWM Fan-Speed Controller

The frequency-select register controls the frequency of the PWM signal. When the PWM signal modulates the power supply of the fan, a low PWM frequency (usually 33Hz) should be used to ensure the circuitry of the brushless DC motor has enough time to operate. When driving a fan with a PWM-to-DC circuit, as in Figure 6, the highest available frequency (35kHz) should be used to minimize the size of the filter capacitors. When using a fan with a PWM control input, the frequency should normally be high as well, although some fans have PWM inputs that accept low-frequency drive.

The duty cycle of the PWM can be controlled in two ways:

- 1) Manual PWM control by setting the duty cycle of the fan directly through the fan-target duty-cycle register (09h).
- 2) Automatic PWM control by setting the duty cycle based on temperature.

Manual PWM Duty-Cycle Control

Setting bits D5 and D4 to zero in the fan-configuration register (0Dh) enables manual PWMOUT control. In this mode, the duty cycle written to the fan-target duty-cycle register controls the PWMOUT duty cycle. The value is clipped to a maximum of 240, which corresponds to a 100% duty cycle. Any value above that is limited to the maximum duty cycle. In manual control mode, the value of the maximum duty-cycle register is ignored and does not affect the duty cycle.

Automatic PWM Duty-Cycle Control

In the automatic control mode, the duty cycle is controlled by the local or remote temperature, according to the settings in the control registers. Below the value of the fan-start temperature threshold (set by registers 03h and 04h), the duty cycle is equal to the fan-start duty cycle. Above the fan-start temperature, the duty cycle increases by one duty-cycle step each time the temperature increases by one temperature step. Below the fan-start temperature, the duty cycle is either 0% or it is equal to the fan-start duty cycle, depending on the value of bit D3 in the configuration byte register. See Figure 8.

The target duty cycle is calculated based on the following formula:

For temperature > fan-start temperature:

$$DC = FSDC + (T - FST) \times \frac{DCSS}{TS}$$

where:

DC = DutyCycle



Figure 8. Automatic PWM Duty Control

FSDC = FanStartDutyCycle

T = Temperature

FST = FanStartTemperature

DCSS = DutyCycleStepSize

TS = TempStep

Duty cycle is recalculated after each temperature conversion if temperature is increasing. If the temperature begins to decrease, the duty cycle is not recalculated until the temperature drops by 5°C from the last peak temperature. The duty cycle remains the same until the temperature drops 5°C from the last peak temperature or the temperature rises above the last peak temperature. For example, if temperature goes up to +85°C and starts decreasing, duty cycle is not recalculated until the temperature reaches +80°C or the temperature rises above +85°C. If temperature decreases further, the duty cycle is not updated until it reaches +75°C.

For temperature < fan-start temperature and bit D3 of the configuration byte register = 0:

$$\text{DutyCycle} = 0$$

For temperature < fan-start temperature and bit D3 of the configuration byte register = 1:

$$\text{DutyCycle} = \text{FanStartDutyCycle}$$

Once the temperature crosses the fan-start temperature threshold, the temperature has to drop below the fan-start temperature threshold minus the hysteresis before the duty cycle returns to either 0% or fan-start duty cycle. The value of the hysteresis is set by D7 of the fan-configuration register.

SMBus-Compatible Temperature Monitor with Automatic PWM Fan-Speed Controller

The duty cycle is limited to the value in the fan maximum duty-cycle register. If the duty-cycle value is larger than the maximum fan duty cycle, it can be set to the maximum fan duty cycle as in the fan maximum duty-cycle register. The temp step is bit D6 of the fan-configuration register (0Dh).

If duty cycle is an odd number, the MAX6641 automatically rounds down to the nearest even number.

Duty-Cycle Rate-of-Change Control

To reduce the audibility of changes in fan speed, the rate of change of the duty cycle is limited by the values set in the duty-cycle rate-of-change register. Whenever the target duty cycle is different from the instantaneous duty cycle, the duty cycle increases or decreases at the rate determined by the duty-cycle rate-of-change byte until it reaches the target duty cycle. By setting the rate of change to the appropriate value, the thermal requirements of the system can be balanced against good acoustic performance. Slower rates of change are less noticeable to the user, while faster rates of change can help minimize temperature variations. Remember that the fan controller is part of a complex control system. Because several of the parameters are generally not known, some experimentation may be necessary to arrive at the best settings.

Power-Up Defaults

At power-up, the MAX6641 has the default settings indicated in Table 1. Some of these settings are summarized below:

- Temperature conversions are active.
- Remote \overline{OT} limit = +110°C.
- Local \overline{OT} limit = +80°C.
- Manual fan mode.
- Fan duty cycle = 0.
- PWM Invert bit = 0.
- PWMOUT is high.

When using an nMOS or npn transistor, the fan starts at full speed on power-up.

Applications Information

Remote-Diode Selection

The MAX6641 can directly measure the die temperature of CPUs and other ICs that have on-board temperature-sensing diodes (see the *Typical Application Circuit*), or they can measure the temperature of a discrete diode-connected transistor.

Pentium is a registered trademark of Intel Corp.

Athlon is a trademark of AMD.

Effect of Ideality Factor

The accuracy of the remote temperature measurements depends on the ideality factor (n) of the remote diode (actually a transistor). The MAX6641 is optimized for $n = 1.008$, which is the typical value for the Intel Pentium® III and the AMD Athlon™ MP model 6. If a sense transistor with a different ideality factor is used, the output data is different. Fortunately, the difference is predictable.

Assume a remote-diode sensor designed for a nominal ideality factor $n_{NOMINAL}$ is used to measure the temperature of a diode with a different ideality factor, n_1 . The measured temperature T_M can be corrected using:

$$T_M = T_{ACTUAL} \left(\frac{n_1}{n_{NOMINAL}} \right)$$

where temperature is measured in Kelvin.

As mentioned above, the nominal ideality factor of the MAX6641 is 1.008. As an example, assume the MAX6641 is configured with a CPU that has an ideality factor of 1.002. If the diode has no series resistance, the measured data is related to the real temperature as follows:

$$T_{ACTUAL} = T_M \left(\frac{n_{NOMINAL}}{n_1} \right) = T_M \left(\frac{1.008}{1.002} \right) = T_M (1.00599)$$

For a real temperature of +85°C (358.15K), the measured temperature is +82.87°C (356.02K), which is an error of -2.13°C.

Effect of Series Resistance

Series resistance in a sense diode contributes additional errors. For nominal diode currents of 10μA and 100μA, change in the measured voltage is:

$$\Delta V_M = R_S (100\mu A - 10\mu A) = 90\mu A \times R_S$$

Since 1°C corresponds to 198.6μV, series resistance contributes a temperature offset of:

$$\frac{90 \frac{\mu V}{\Omega}}{198.6 \frac{\mu V}{^\circ C}} = 0.453 \frac{^\circ C}{\Omega}$$

Assume that the diode being measured has a series resistance of 3Ω. The series resistance contributes an offset of:

$$3\Omega \times 0.453 \frac{^\circ C}{\Omega} = +1.36^\circ C$$

SMBus-Compatible Temperature Monitor with Automatic PWM Fan-Speed Controller

MAX6641

The effects of the ideality factor and series resistance are additive. If the diode has an ideality factor of 1.002 and series resistance of 3Ω , the total offset can be calculated by adding error due to series resistance with error due to ideality factor:

$$1.36^{\circ}\text{C} - 2.13^{\circ}\text{C} = -0.1477^{\circ}\text{C}$$

for a diode temperature of $+85^{\circ}\text{C}$.

In this example, the effect of the series resistance and the ideality factor partially cancel each other.

For best accuracy, the discrete transistor should be a small-signal device with its collector connected to GND and base connected to DXN. Table 6 lists examples of discrete transistors that are appropriate for use with the MAX6641.

The transistor must be a small-signal type with a relatively high forward voltage; otherwise, the A/D input voltage range can be violated. The forward voltage at the highest expected temperature must be greater than 0.25V at $10\mu\text{A}$, and at the lowest expected temperature, the forward voltage must be less than 0.95V at $100\mu\text{A}$. Large power transistors must not be used. Also, ensure that the base resistance is less than 100Ω . Tight specifications for forward-current gain ($50 < \beta < 150$, for example) indicate that the manufacturer has good process controls and that the devices have consistent VBE characteristics.

ADC Noise Filtering

The integrating ADC used has good noise rejection for low-frequency signals such as 60Hz/120Hz power-supply hum. In noisy environments, high-frequency noise reduction is needed for high-accuracy remote measurements. The noise can be reduced with careful PC board layout and proper external noise filtering.

High-frequency EMI is best filtered at DXP and DXN with an external 2200pF capacitor. Larger capacitor values can be used for added filtering, but do not exceed 3300pF because larger values can introduce errors due to the rise time of the switched current source.

PC Board Layout

Follow these guidelines to reduce the measurement error of the temperature sensors:

- 1) Place the MAX6641 as close as is practical to the remote diode. In noisy environments, such as a computer motherboard, this distance can be 4in to 8in typically. This length can be increased if the worst noise sources are avoided. Noise sources include CRTs, clock generators, memory buses, and ISA/PCI buses.

Table 6. Remote-Sensor Transistor Manufacturers

MANUFACTURER	MODEL NO.
Central Semiconductor (USA)	CMPT3906
Rohm Semiconductor (USA)	SST3906
Samsung (Korea)	KST3906-TF
Siemens (Germany)	SMBT3906

- 2) Do not route the DXP-DXN lines next to the deflection coils of a CRT. Also, do not route the traces across fast digital signals, which can easily introduce 30°C error, even with good filtering.
- 3) Route the DXP and DXN traces in parallel and in close proximity to each other, away from any higher voltage traces, such as 12VDC. Leakage currents from PC board contamination must be dealt with carefully since a $20\text{M}\Omega$ leakage path from DXP to ground causes about 1°C error. If high-voltage traces are unavoidable, connect guard traces to GND on either side of the DXP-DXN traces (Figure 9).
- 4) Route through as few vias and crossunders as possible to minimize copper/solder thermocouple effects.
- 5) When introducing a thermocouple, make sure that both the DXP and the DXN paths have matching thermocouples. A copper-solder thermocouple exhibits $3\mu\text{V}/^{\circ}\text{C}$, and takes about $200\mu\text{V}$ of voltage error at DXP-DXN to cause a 1°C measurement error. Adding a few thermocouples causes a negligible error.
- 6) Use wide traces. Narrow traces are more inductive and tend to pick up radiated noise. The 10-mil widths and spacing recommended in Figure 9 are not absolutely necessary, as they offer only a minor improvement in leakage and noise over narrow traces. Use wider traces when practical.
- 7) Add a 200Ω resistor in series with V_{CC} for best noise filtering (see the *Typical Application Circuit*).
- 8) Copper cannot be used as an EMI shield; only ferrous materials such as steel work well. Placing a copper ground plane between the DXP-DXN traces and traces carrying high-frequency noise signals does not help reduce EMI.

SMBus-Compatible Temperature Monitor with Automatic PWM Fan-Speed Controller



Figure 9. Recommended DXP-DXN PC Traces

Twisted-Pair and Shielded Cables

Use a twisted-pair cable to connect the remote sensor for remote-sensor distance longer than 8in or in very noisy environments. Twisted-pair cable lengths can be between 6ft and 12ft before noise introduces excessive errors. For longer distances, the best solution is a shielded twisted pair like that used for audio microphones. For example, Belden 8451 works well for distances up to 100ft in a noisy environment. At the device, connect the twisted pair to DXP and DXN and the shield to GND. Leave the shield unconnected at the remote sensor.

For very long cable runs, the cable's parasitic capacitance often provides noise filtering, so the 2200pF capacitor can often be removed or reduced in value. Cable resistance also affects remote-sensor accuracy. For every 1Ω of series resistance, the error is approximately 0.5°C .

Thermal Mass and Self-Heating

When sensing local temperature, these devices are intended to measure the temperature of the PC board to which they are soldered. The leads provide a good thermal path between the PC board traces and the die. Thermal conductivity between the die and the ambient air is poor by comparison, making air temperature measurements impractical. Because the thermal mass of the PC board is far greater than that of the MAX6641, the devices follow temperature changes on the PC board with little or no perceivable delay. When measuring the temperature of a CPU or other IC with an on-chip sense junction, thermal mass has virtually no effect. The measured temperature of the junction tracks the actual temperature within a conversion cycle.

When measuring temperature with discrete sensors, smaller packages, such as μMAX es, yield the best thermal response times. Take care to account for thermal gradients between the heat source and the sensor, and ensure stray air currents across the sensor package do not interfere with measurement accuracy. Self-heating does not significantly affect measurement accuracy. Remote-sensor self-heating due to the diode current source is negligible.

Typical Application Circuit



Chip Information

TRANSISTOR COUNT: 18,769

PROCESS: BiCMOS

SMBus-Compatible Temperature Monitor with Automatic PWM Fan-Speed Controller

Package Information

(The package drawing(s) in this data sheet may not reflect the most current specifications. For the latest package outline information, go to www.maxim-ic.com/packages.)

MAX6641



Maxim cannot assume responsibility for use of any circuitry other than circuitry entirely embodied in a Maxim product. No circuit patent licenses are implied. Maxim reserves the right to change the circuitry and specifications without notice at any time.

Maxim Integrated Products, 120 San Gabriel Drive, Sunnyvale, CA 94086 408-737-7600 17