



Integrated Circuits
Selection Guide

High Voltage, Analog & Mixed Signal ICs,
Optically Isolated Devices



Design with Confidence

Supported by our Deep Application Expertise and Extensive Portfolio

About this guide

IXYS Integrated Circuits, formerly a wholly owned subsidiary of IXYS Corporation, is now part of Littelfuse, Inc. IXYS Integrated Circuits designs, manufactures, and markets a wide variety of semiconductor devices and is a major provider of optically isolated electronic components.

IXYS Integrated Circuits' unique mix of high voltage wafer fabrication, isolation barrier expertise, multi-chip packaging experience, and expertise in analog, mixed signal, and power design, points the way to greater functionality in a smaller footprint at lower cost for your designs.

Topic	Page	Topic	Page
Products	4	Solid State Relay Product Specifications	22–30
Solid State Relays	5–8	Fault Protected Solid State Relay Product Specifications	31–32
IGBT & MOSFET Gate Drivers	9–10	Optically Isolated Power Relay Product Specifications	33
Sic MOSFET & IGBT Gate Drivers	11	Optically Isolated AC Power Switch Product Specifications	34–37
IGBT & MOSFET High-Speed Gate Drivers	12–13	IGBT & MOSFET Low-Side Gate Driver Product Specifications	38–40
High Voltage Isolated Analog Switches	14–15	SiC MOSFET & IGBT Low-Side Gate Driver Product Specifications	41
Optocouplers	16	IGBT & MOSFET High-Speed Gate Driver Product Specifications	42–43
MOSFETS	17	Optically Isolated Gate Driver Product Specifications	44
Non-Volatile Digitally Programmable Capacitors	18	Linear/Standard Optocoupler Product Specifications	45
High Voltage LED Drivers	19	Depletion Mode MOSFET Product Specifications	46
Multifunction Products: SSR/Optocouplers	20	Telecommunication Product Specifications	47
Voltage Monitoring & Sensing IC	21	Multifunction Product: SSR/Optocoupler Product Specifications	48–49

Specifications, descriptions, and illustrative material in this literature are as accurate as known at the time of publication, but are subject to changes without notice. Visit Littelfuse.com for more information.

OptoMOS® is a registered trademark of IXYS Integrated Circuits

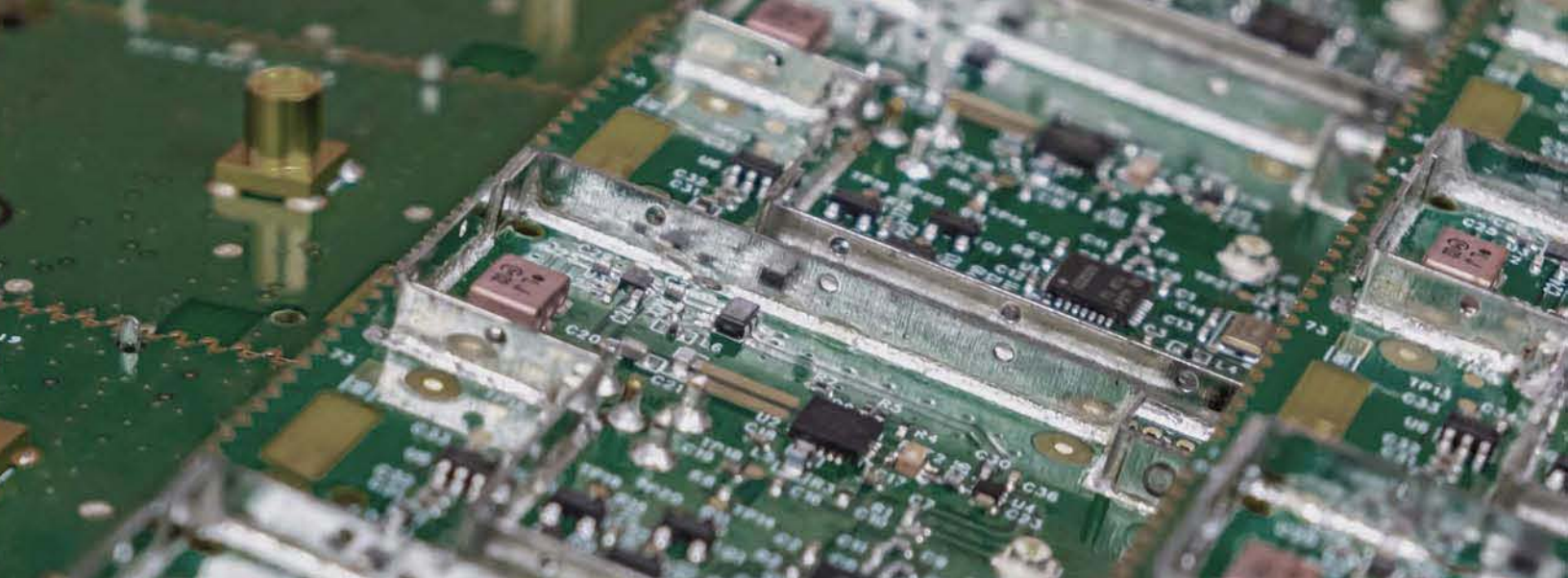

Littelfuse: Everywhere, Every Day

Founded in 1927, Littelfuse has become the world's most respected circuit protection brand, with well-established and growing platforms in power control and sensing technologies. Today, we are a global company, offering a diverse and extensive product portfolio—fuses, semiconductors, polymers, ceramics, relays, sensors, and more—serving the electronics, automotive, and industrial markets. Each is manufactured to exacting quality standards and backed by an unwavering commitment to technical support and customer service.

Our history of innovation, combined with our customer-first culture, drives us to collaborate with you to develop safer, more reliable products that are energy efficient and compliant with global regulations. We will partner with you to solve complex problems wherever electrical energy is used, bringing design, engineering, and technical expertise to deliver business results.

Why Choose Littelfuse

Littelfuse is the global leader in circuit protection solutions. We are the only company to offer all of the pertinent circuit protection technologies, with products that can be used in virtually everything that uses electrical energy. Complementing our wide portfolio of circuit protection products is a global network of design and technical support expertise. We offer decades of design experience to help you address application challenges and achieve regulatory compliance.

Your Single Source

Littelfuse offers an extensive circuit protection product line. We design forward-thinking, application-specific solutions to provide assurance that your most demanding requirements will be met. Our goal is to provide the most complete range of options so that you will not have to compromise.

Testing Support

Littelfuse can help ensure that your products will withstand most common threats repeatedly and will fail safely under extreme circumstances. We can serve as an independent source to provide assistance as you design by offering lab testing capabilities for customer applications. This testing includes industry-specific required power fault and Electrostatic Discharge (ESD) / Electrically Fast Transients (EFT) / lightning surge conditions.

Application Knowledge

For over 90 years, Littelfuse has maintained a focus on circuit protection, and we will continue to adapt as technologies evolve. Engineers and circuit designers around the world have come to rely on Littelfuse products and application knowledge to support their designs.

Global Support

Littelfuse stays close to customers. With manufacturing, lab, and design facilities located around the globe, application knowledge and technical support are locally available. Also, we offer a network of regional customer support offices and hundreds of independent authorized distributor contacts to assist you. Visit Littelfuse.com/contact-us to find local support near you.

Standards Compliance Expertise

Most Littelfuse products comply with a wide range of applicable industry and government guidelines as well as our own rigorous quality and reliability criteria. We continually look forward and adapt to changing requirements so that our products will comply with industry-specific national and international standards, such as CCC, CSA, IEC, IEEE, ISO, ITU, Meti, RoHs, Telcordia, TIA, and many more.

Operational Excellence

With our global manufacturing footprint, Littelfuse is firmly committed to manufacturing quality products at a competitive price. We build quality into our products and services, striving for zero defects in everything we do, thereby reducing cost and increasing your total satisfaction. We strive to exceed your expectations every day.

Quality Assurance

Our global manufacturing facilities abide by strict quality assurance requirements and hold the following quality management system registrations:

- ISO 9001
- ISO14001
- IATF 16949

IXYS Integrated Circuits, formerly a wholly owned subsidiary of IXYS Corporation, is now part of Littelfuse, Inc. IXYS Integrated Circuits designs, manufactures, and markets a wide variety of semiconductor devices and is a major provider of optically isolated electronic components.

IXYS Integrated Circuits' unique mix of high voltage wafer fabrication, isolation barrier expertise, multi-chip packaging experience, and expertise in analog, mixed signal, and power design, points the way to greater functionality in a smaller footprint at lower cost for your designs.

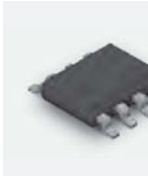

IGBT & MOSFET Drivers

High voltage, low-side, and optically isolated IGBT and MOSFET drivers, many of which are AEC-Q100 qualified.

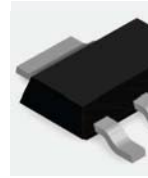

N-Channel Depletion Mode MOSFETs

Normally closed discrete small power MOSFETs.



SiC-Gate Drivers

Specialized drivers for SiC-MOSFETs and high power IGBTs.



LED Drivers

High-efficiency, high-brightness LED drivers with wide input operating voltage range up to 550V_{DC}.



IGBT & MOSFET Drivers

- High-Side and Low-Side
- Half-Bridge
- 3-Phase



HV Switch Arrays

High voltage isolated analog switch arrays.



Solid State Relays (SSR)

One of the industry's broadest lines of optically isolated SSRs, available in a wide selection of configurations, blocking voltages, and load currents.



Non-volatile Digitally Programmable Capacitors

Provide capacitive offset trimming for capacitance sensitive circuits.



Fault Protected Solid State Relays

Active current limiting SSRs with thermal management.



Multifunction SSR/Optocouplers

Allows designers to consolidate circuit functions into a single device.



Normally Open Power Relays

Packages with heat dissipating, isolating ceramic substrate that are heat-sink compatible for higher current applications.



Telecommunications Market

Phone-line interface and monitoring devices.



Optically Isolated AC Power Switches

SCR-based AC Power Switches (zero-cross & rapid turn-on).

Solid State Relays

IXYS Integrated Circuits' line of solid state relays is one of the broadest in industry. The devices use discrete semiconductor components and the patented OptoMOS® architecture to deliver fast, reliable, bounce-free switching in a compact design. Semiconductor relays are an ideal replacement for larger reed and electromechanical relays. Compared to these old electromagnetic technologies, our OptoMOS® relays offer significantly lower drive current, small package size, no susceptibility to magnetic interaction, and solid state reliability. All of these are key requirements for the design of today's complex, low-power, multi-channel products.

Features & Benefits

- Low drive current
- High reliability
- No EMI/RFI generation
- AC or DC switching
- Current limiting devices available
- Fault protected versions available
- Low off-state leakage

Applications

- Instrumentation
- Multiplexers
- Data acquisition/ electronic switching
- Meters (Watt-hour, water, gas)
- Medical equipment (patient/ equipment isolation)
- Security
- Industrial controls
- Telecomm / datacomm

Output Configurations

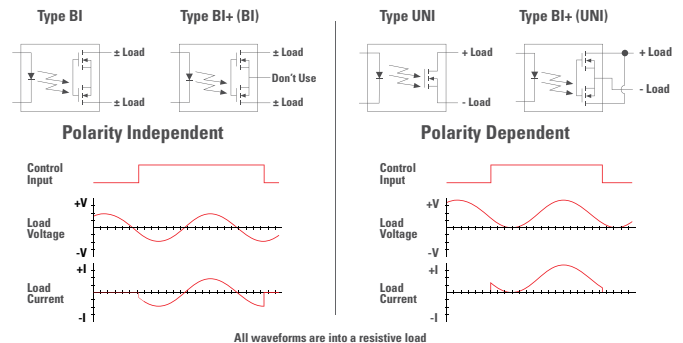

Type BI relays conduct load current in both directions.

Type BI+ relays, in BI configuration, conduct load current in both directions.

Type UNI relays conduct load current from the positive terminal to the negative terminal only.

Type BI+ relays, in UNI configuration with output MOSFETs wired in parallel, enable higher load current from positive terminal to negative terminal only.

The accompanying SSR tables reference these types (BI, BI+, & UNI) for all devices listed.

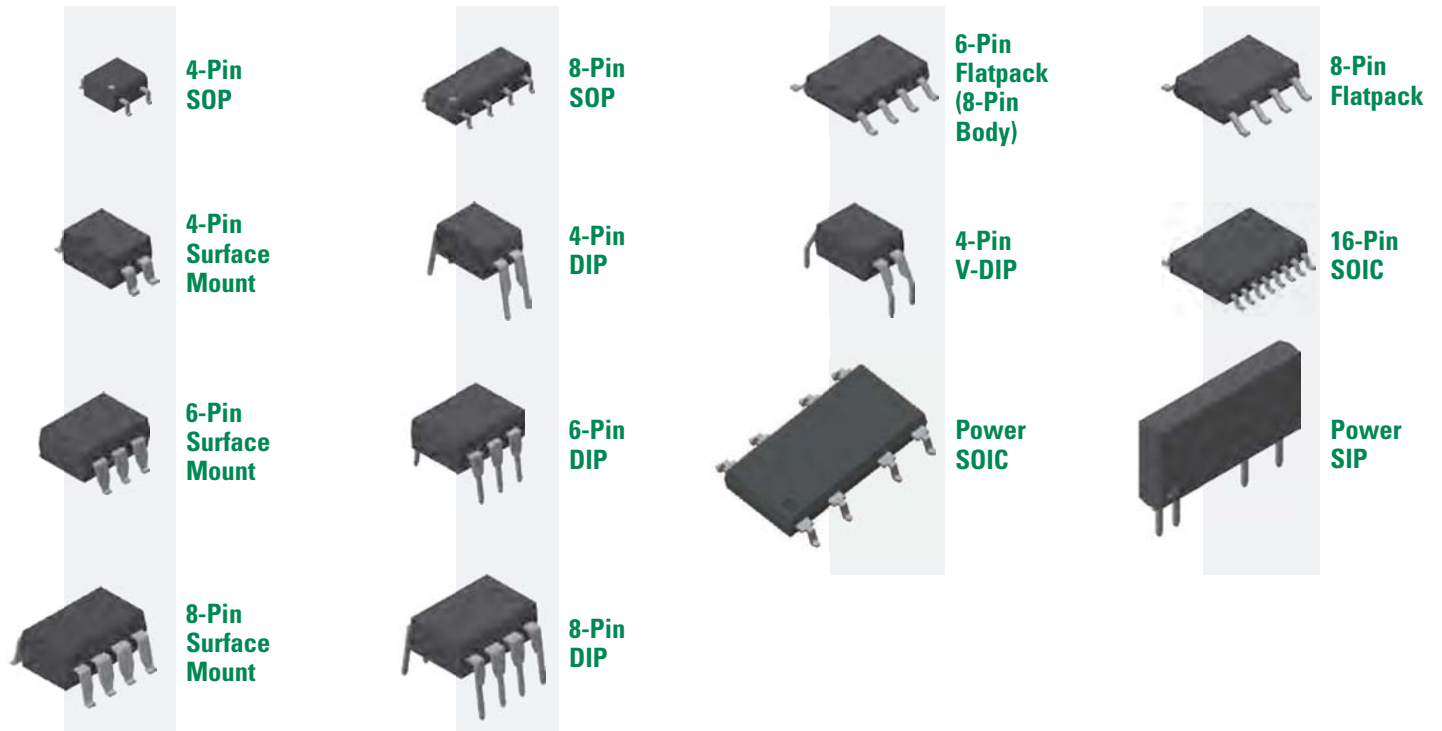

Note – Images are to scale

Fault Protected Relays

Active Current Limiting SSRs with Voltage Triggered Shutdown & Thermal Management

All of the Fault Protected Solid State Relays (SSR) listed below feature Active Current Limiting and Thermal Management while the CPC1540, CPC1563, and CPC1593 additionally feature Voltage Triggered Shutdown, or VTS.

Fault Protected SSRs can directly replace footprint-compatible standard SSRs in existing designs to improve end-product survivability.

These Fault Protected relays resume normal operation upon removal of the fault condition or upon cycling the input control current. Should the fault condition repeat or persist, the fault protection will immediately resume.

Active Current Limiting: All Fault Protected SSRs limit load current to protect both the load and the SSR.

Voltage Triggered Shutdown: CPC1540, CPC1563, and CPC1593 incorporate a third protection feature called Voltage Triggered Shutdown (VTS).

During a current limiting event this advanced thermal management protection feature reduces the relay current to $<100\mu\text{A}$ whenever the voltage drop across the relay exceeds a non-adjustable predetermined threshold thereby preventing excessive heating of the SSR.

Thermal Management: All Fault Protected relays include the traditional thermal management feature that deactivates the SSR outputs anytime the die temperature exceeds a safe limit regardless of the Active Current Limiting state and when equipped, the Voltage Triggered Shutdown state. This feature provides excellent power cross immunity.

With I_{LIMIT} Without VTS

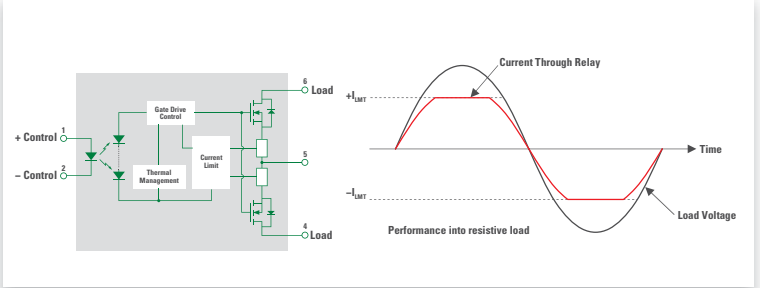

With I_{LIMIT} With VTS

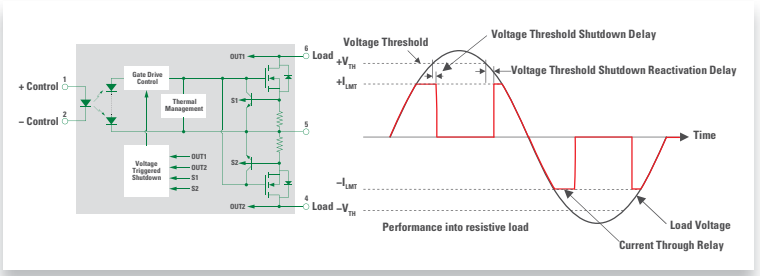

Features & Benefits

- Provide excellent power-cross immunity
- Resumes normal operation after fault is removed
- Ideal for use in electromagnetically noisy environments

Part Number	Blocking Voltage (V_P)	Input Control Current (mA)	On-Resistance (Maximum)		Load Current (Maximum)		Current Limit (Maximum)		* VTS Threshold (V_{TH}) (V)	Switching Speed (t_{on} / t_{off}) (ms)	Isolation Voltage (V_{RMS})	Features & Comments
			DC-Only (Ω)	AC (Ω)	DC-Only (mA)	AC (mA)	DC-Only (mA_P)	AC (mA_P)				
CPC1510	250	2	3.75	15	350	200	920	450	-	2 / 2	3750	Industrial applications
CPC1511	230	2.5	-	4	-	450	-	1400	-	4 / 2	3750	Industrial applications
CPC1540	350	2	6.75	25	250	120	570	285	100	2 / 2	3750	PSTN hook switch applications
CPC1560	60	1.1	1.4	5.6	600	300	1500	900	-	0.1 / 0.4	3750	Fast switching speeds
CPC1561B	60	2.5	-	0.245	-	1000	-	3000	-	2.5 / 0.5	3750	1A Load current rating to 60°C
CPC1563	600	2	11.75	35	250	120	570	285	100	2 / 2	3750	High blocking voltage
CPC1593	600	2	11.75	35	250	120	570	285	21	2 / 2	3750	Power supply start-up



6-Pin Surface Mount



6-Pin DIP



8-Pin DIP



8-Pin Surface Mount



16-Pin SOIC



Power SIP

Note – Images are to scale

Optically Isolated Power Relays

For power applications requiring a non-biased heat sink, the i4-PAC and ISOPLUS-264 power relays are an ideal solution. These devices utilize isolated Direct Copper Bond (DCB) ceramic substrates which have got superior thermal properties. These power relay devices are specified for both, to operate free air and mounted on a heat sink.

Features & Benefits

- Blocking voltage up to 1000V_p
- On-resistance as low as 0.05 Ohm
- Turn-on/off switching speeds from 5ms to 25ms
- MOSFET-based AC/DC and DC-only power relays
- Load current up to 22.8A_{DC} (with 5°C/W heat sink)
- 2500V_{RMS} isolation from input to output and to the ceramic substrate
- Isolated, low thermal impedance pad for heat sink applications
- Low input control current
- Low thermal impedances, junction to case (θ_{jc}):
 - 0.30°C/W - ISOPLUS-264
 - 0.35°C/W - i4-PAC

Applications

- Medical equipment
- Railroad/traffic controls
- Industrial control
- Test and measurement equipment

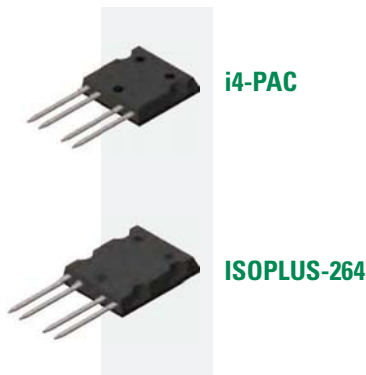

Note – Images are to scale

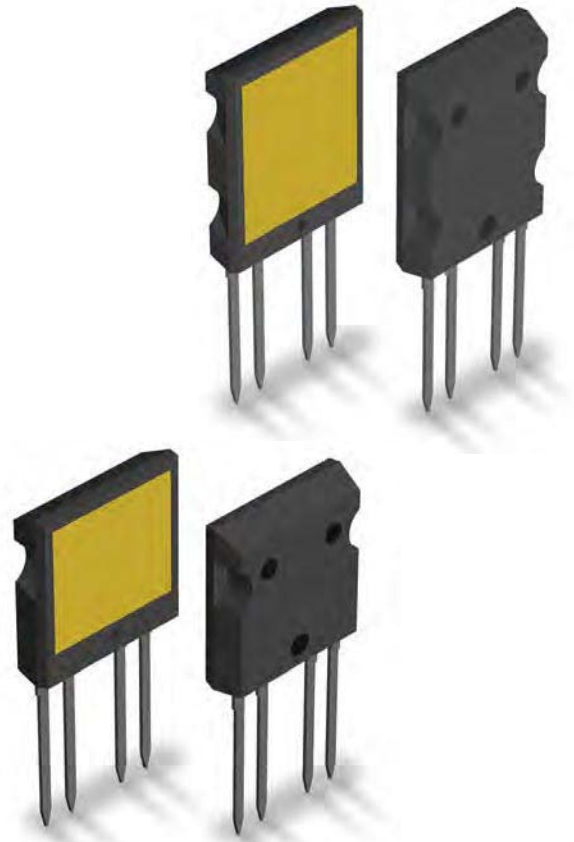

Heat dissipating, isolating ceramic substrates are heat-sink compatible for higher current applications.

1-Form-A Bidirectional

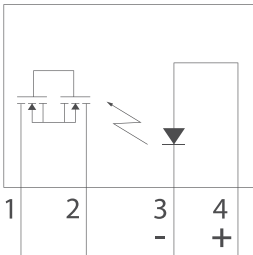

1-Form-A Unidirectional

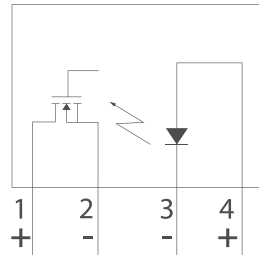

What is Direct Copper Bonding (DCB)?

ISOPLUS-264™ and i4-PAC packages utilize DCB ceramic substrates instead of the usual copper lead frame. **DCB** stands for **D**irect **C**opper **B**onding and denotes a process in which copper and a ceramic material are fused together, at high temperatures.

The design of these patented packages is revolutionary: The silicon chips are soft soldered onto the DCB ceramic substrate which provides both, high isolation capability of 2500V_{RMS} with an unbeatable low thermal resistance compared to conventional, externally mounted isolation materials.



Optically Isolated AC Power Switches

The OptoMOS® line of AC Power Switches use dual power SCR thyristor outputs to produce an alternative to optocoupler and Triac circuits. The input and output circuits are optically coupled to provide up to 5000V_{RMS} of galvanic isolation and noise immunity between control and load circuits. The product line includes devices with blocking voltages of up to 800V_{AC} peak. Long life and environmental integrity make these power switches ideal for controlling a variety of AC load circuits. Available are versions with zero-cross and rapid turn-on switching characteristic:

Zero-cross turn-on devices feature tightly controlled zero-cross circuitry that minimizes the generation of transients when turning on AC loads.

Rapid turn-on devices turn on the load when the control input goes true regardless of the load voltage phase, and turn off when the load current crosses zero. Rapid turn-on devices are predominantly used to control inductive loads like motors, valves, or solenoids.

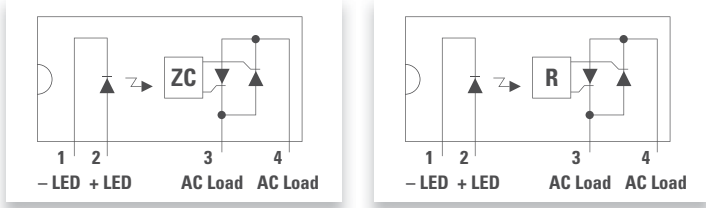

Features & Benefits

- Load current range from 250mA to 20A (with 5°C/W heat sink)
- 5mA input sensitivity
- Low EMI and RFI generation
- DC control, AC switching
- Optically isolated
- High noise immunity
- Input to output isolation from 2500V_{RMS} to 5000V_{RMS}

Applications

- Programmable controls
- Process control
- Power control panels
- Remote switching
- Gas pump electronics
- Contactors
- Solenoids
- Motor controls
- Heater controls

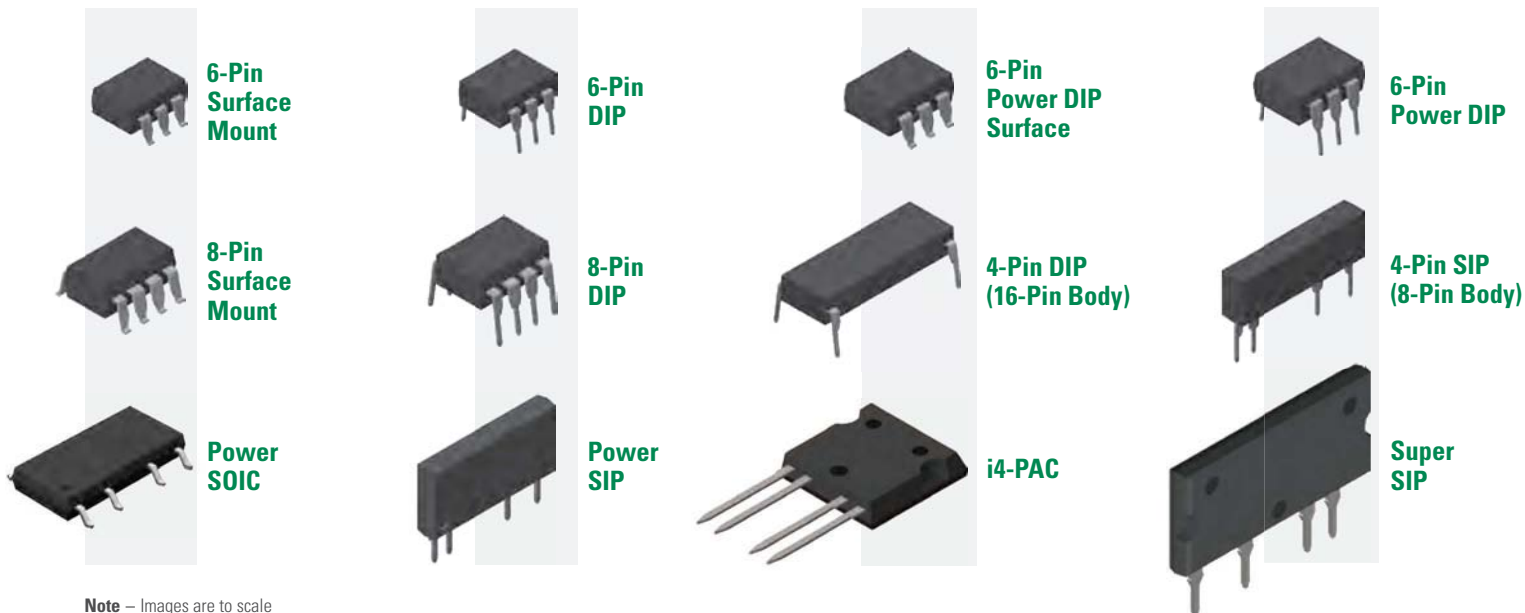
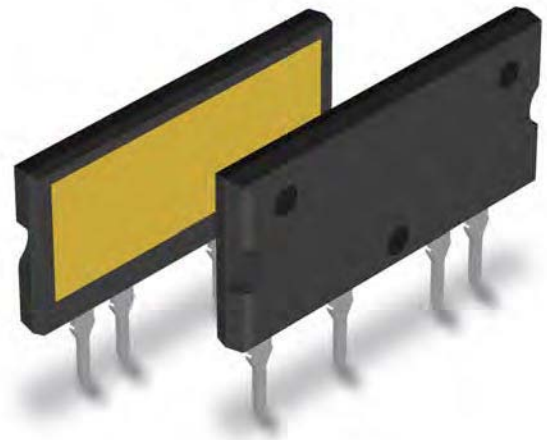

Note – Images are to scale

CPC1596: 570V Optically Isolated Load-Biased Gate Driver

The CPC1596 is an optically isolated, load-biased Gate Driver that requires no additional power supply to bias the external MOSFET gates; in the off-state it regulates the voltage drawn from the load (up to 570V) down to 12.2V for internal use. It is specifically designed for low duty cycle switching applications such as an optically isolated DC relay using a single MOSFET or an AC relay with two MOSFETs.

The CPC1596 accomplishes very fast MOSFET turn-on by supplying charge stored in an external capacitor to the MOSFET gate when input control current is applied to the device's LED. After the MOSFET is turned on, photocurrent from the internal optocoupler keeps the MOSFET active for as long as sufficient input control current is applied assuring very low-frequency operation. When the MOSFET is turned off, the storage capacitor charges from the load voltage via the regulated internal voltage in preparation for the next turn-on.

Provided in a small, 8-pin package and requiring no separate power supply, the CPC1596 provides a flexible design solution that minimizes PCB real estate.

Features & Benefits

- Requires No Load-side Power Supply
- Drives External Power MOSFET
- Only 2.5mA Input LED Current to Drive External MOSFET
- 3750V_{RMS} Input-to-Output Isolation

Applications

- Industrial Controls
- Instrumentation
- Medical Equipment Isolation
- Electronic Switching
- I/O Subsystems
- Appliances

CPC1596 AC Application Circuit

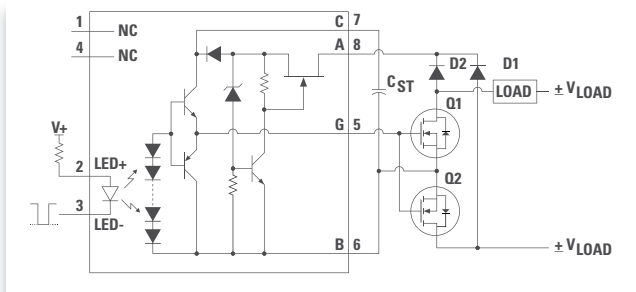

CPC1596 DC Application Circuit

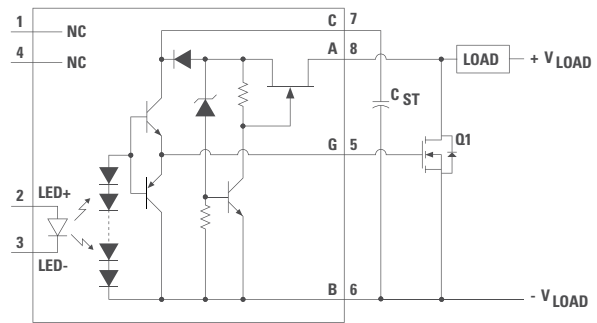

Optically Isolated Load-Biased Gate Drivers

The CPC1580 and CPC1590 devices are MOSFET Gate Driver that require no external power supply: They regulate the input voltage drawn from the load (up to 65V or 200V respectively), down to 12.2V for internal use. They are specifically designed for low duty cycle switching applications that drive up to 4nF of gate capacitance.

The CPC1580 and CPC1590 devices accomplish very fast MOSFET turn-on by supplying stored charge, from an external capacitor, to the MOSFET gate when LED input control current is applied. After the MOSFET is turned on, photocurrent from the input optocoupler keeps it on for as long as sufficient input control current flows, so there is no low-frequency operating limit. When the MOSFET is turned off, the storage capacitor charges from the device's regulated internal voltage in preparation for the next turn-on.

Features & Benefits

- No external IC power supply required
- Low drive power requirements (TTL/CMOS compatible)
- Load voltages up to 200V
- Fast switching speeds: 40µs on; 400µs off

Applications

- Instrumentation
- Multiplexers
- I/O subsystems
- Meters (Watt-Hour, water, gas)
- Medical equipment (patient/equipment isolation)
- Security
- Industrial controls

CPC1590 Application Diagram

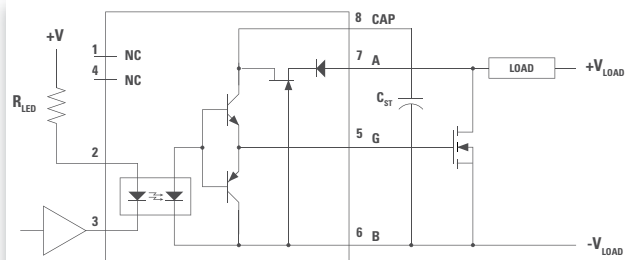

8-Pin DIP



8-Pin Surface Mount



8-Pin Flatpack

Note – Images are to scale

Low-Side Gate Drivers

IXYS Integrated Circuits offers powerful families of ultra-fast Low-Side Gate Drivers for MOSFETs and IGBTs, with a large mix of logic configurations, packaging, and drive current capabilities. Five of these devices are AEC-Q100 qualified.

Single-output and dual-output low-side driver ICs include selectable options for logic combinations. The range of current ratings offered is the broadest available, extending to 30A peak, which is the LARGEST PEAK DRIVE CURRENT capability for an integrated driver on the market.

In all series devices, internal circuitry eliminates cross conduction and current “shoot-through,” and the driver is virtually immune to latch up.

Features & Benefits

- 1.5A to 30A peak source/sink drive current
- Wide operating voltage range up to 35V
- -40°C to +125°C extended operating temperature range
- Logic input withstands negative swing of up to -5V
- Dual drivers have matched rise and fall times
- Low propagation delay time
- Low output impedance

Applications

- Efficient power MOSFET and IGBT switching
- Switch mode power supplies
- Motor controls
- DC to DC converters
- Class-D switching amplifiers
- Pulse transformer driver

Available Single and Dual Driver Logic Versions

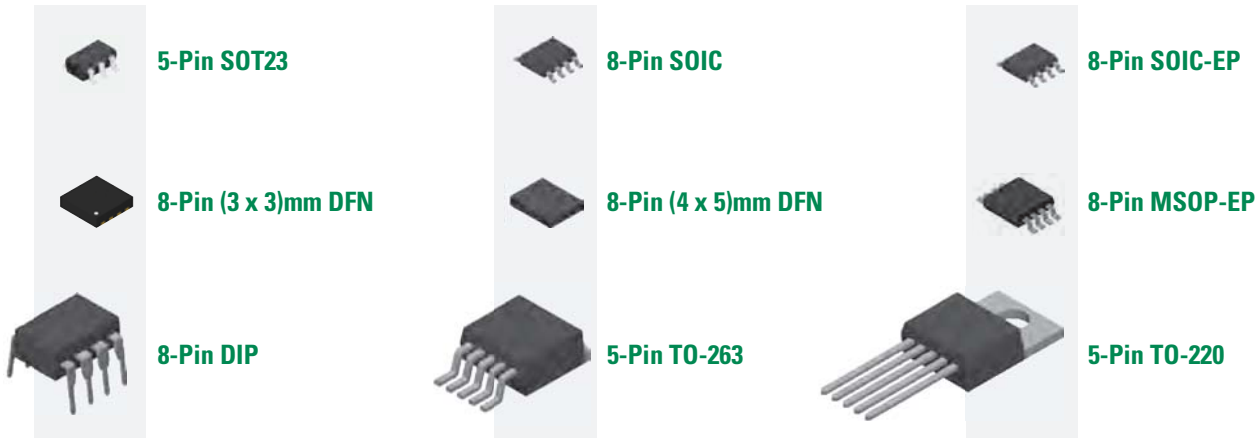
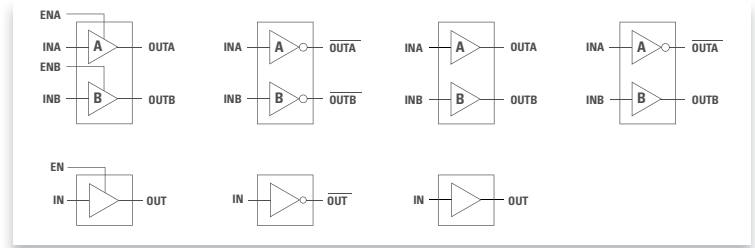

Note – Images are to scale

Optically Isolated Photovoltaic Gate Drivers

Photovoltaic gate drivers couple infrared light emitting diodes with proprietary photovoltaic integrated circuits to provide 3750V_{RMS} of input-to-output isolation. When input current is applied to the LED, the emitted light will be converted by the photodiode array to electrical energy and generate a floating voltage at the output. In addition to providing voltage for turn-on of discrete MOSFETs, these patented ICs feature a gate-clamping circuit to provide fast turn-off. Used in conjunction with discrete MOSFETs, these gate drivers are well suited for use in discrete solid state relay designs and other isolated switching applications.

Features & Benefits

- Isolated 5.5V and 12V photovoltaic output
- Floating outputs for parallel or series configuration
- Dual optically isolated photovoltaic devices

Applications

- MOSFET driver
- Isolated floating power source
- Discrete solid state relay designs

Dual Optically Isolated Photovoltaic Driver

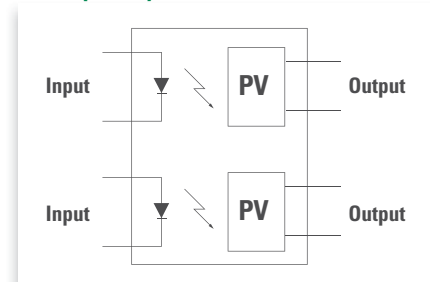

IX4351NE 9A Low-Side Gate Driver IX4351NEAU AEC-Q100 Automotive Qualified Version

The IX4351NE is designed specifically to drive SiC MOSFETs and high power IGBTs. Separate 9A source and sink outputs allow for tailored turn-on and turn-off timing while minimizing switching losses. An internal negative charge regulator provides a selectable negative gate drive bias for improved dV/dt immunity and faster turn-off.

Desaturation detection circuitry senses an overcurrent condition of the SiC MOSFET or IGBT and initiates a soft turn off, thus preventing a potentially damaging dV/dt event. The non-inverting logic input, IN, is TTL and CMOS compatible; internal level shifters provide the necessary bias to accommodate negative gate drive bias voltages. Additional protection features include UVLO detection and thermal shutdown. An open drain FAULT output signals a fault condition to the microcontroller.

The IX4351NE is rated for an operational temperature range of -40°C to $+125^{\circ}\text{C}$, and is available in a thermally enhanced 16-pin narrow SOIC package.

Features & Benefits

- AEC-Q100 Automotive-Grade qualified: IX4351NEAU
- Separate 9A peak source and sink outputs
- V_{DD} input supply voltage range: +13V to +25V
- Adjustable gate drive voltage range: -10V to $+25\text{V}$
- Internal logic level shifters
- Desaturation detection with soft shutdown sink driver
- Under Voltage Lockout (UVLO)
- Thermal shutdown
- Open drain FAULT output
- TTL and CMOS compatible input

Applications

- Driving SiC MOSFETs and IGBTs
- On-board charger and DC charging station
- AC/DC and DC/DC converters
- Industrial power inverters
- Motor controllers

Typical IX4351 Application Circuit

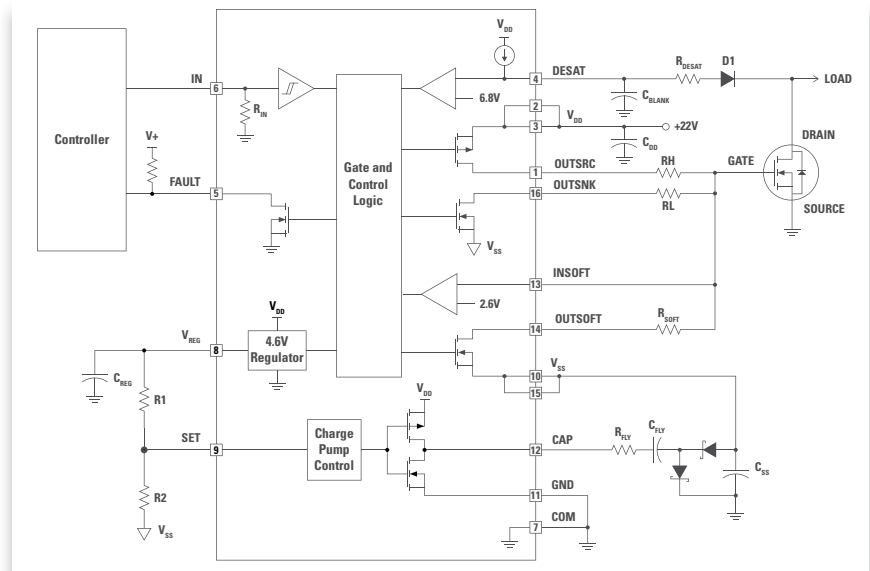

IX4351NE and IX4351NEAU
(16-pin narrow SOIC package with exposed pad)

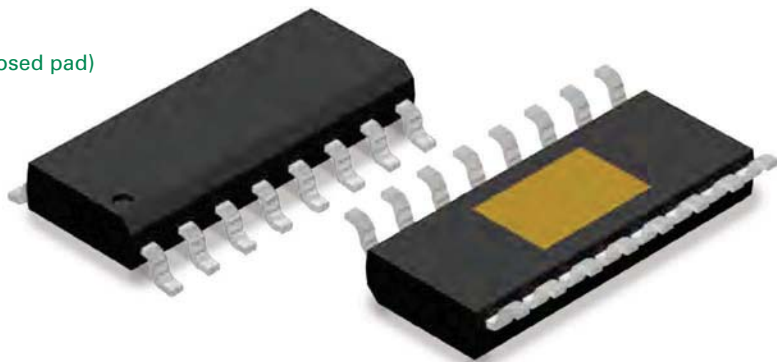

High-Side and Low-Side Gate Driver ICs

High-side and low-side drivers control two N-Channel MOSFETs or IGBTs in fast switching applications. The gate driver converts PWM input signals into gate-signals compatible to MOSFETs or IGBTs, providing a robust and efficient power semiconductor control. An integrated bootstrap circuit is generating a floating voltage with enables the high-side driver to operate up to $600V_{DC}$.

The drivers accept wide V_{DD} supply voltage as well as wide logic input voltage ranges. Various built-in protection features ensure safe operation of the driver and the driven power semiconductors.

Features & Benefits

- High-side operation up to $600V_{DC}$
- Outputs tolerant to negative transients
- Supply voltage range: 10V to 20V
- Logic input voltage range: 3.3V to 20V
- Cycle-by-cycle edge-triggered shutdown circuitry
- Under Voltage Lockout (UVLO)
- Operating temperature range: $-40^{\circ}C$ to $+125^{\circ}C$

Applications

- DC-DC Converters
- AC-DC Inverters
- Motor Controls
 - Servo Motor Control
 - Pumps and Fans
- Class D Power Amplifiers
- Uninterruptable Power Supplies (UPS)
- Welding
- Induction Cooking



LF2110 and LF2113 Application Circuit

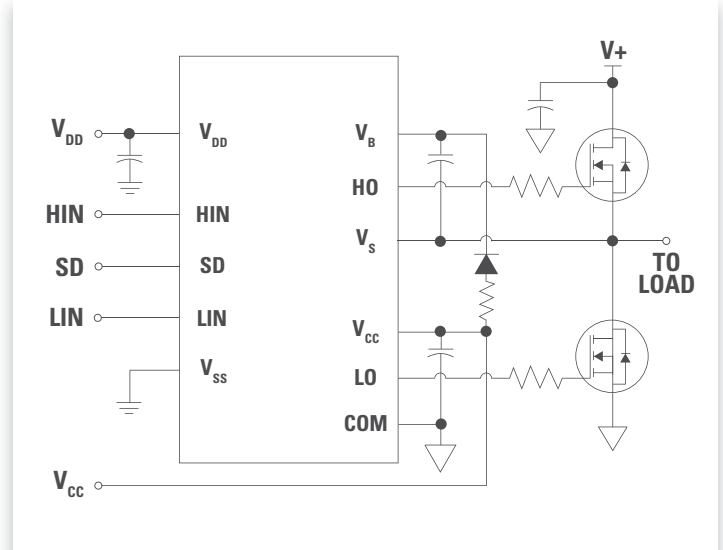

Littelfuse MOSFET and IGBT Devices

Discrete Packaged MOSFETs

Littelfuse's broad and deep Power MOSFETs portfolio includes linear and depletion mode Power MOSFETs that set the industry standard for high-voltage, high-power discrete MOSFETs applications.



Scan the code to learn more.



Discrete Packaged IGBTs

Littelfuse offers the largest selection of IGBT devices on the power semiconductor market. Benefits include low energy losses and exceptional device ruggedness while maintaining low on-state voltages.



Scan the code to learn more.

Half-Bridge Gate Driver ICs

Half-bridge gate drivers control two N-Channel MOSFETs or IGBTs in fast switching applications. The gate driver converts PWM input signals into gate-signals compatible to MOSFETs or IGBTs, providing a robust and efficient power semiconductor control. An integrated bootstrap circuit is generating a floating voltage with enables the high-side driver to operate up to $600V_{DC}$.

The drivers accept wide V_{DD} supply voltage as well as wide logic input voltage ranges. Various built-in protection features ensure safe operation of the driver and the driven power semiconductors.

Features & Benefits

- High-side operation up to $600V_{DC}$
- Outputs tolerant to negative transients
- Supply voltage range: 10V to 20V
- Logic input voltage range: 3.3V to 20V
- Fixed or programmable deadtime
- Cycle-by-cycle edge-triggered shutdown circuitry
- Under Voltage Lockout (UVLO)
- Operating temperature range: $-40^{\circ}C$ to $+125^{\circ}C$

Applications

- Motor Controls / Drives
- Stepper Motor Drives
- DC/DC-Converters
- AC/DC-Inverters
- Robotics
- Cordless Power Tools
- Drones



8-Pin
SOIC



14-Pin
SOIC

LF2103 Application Circuit

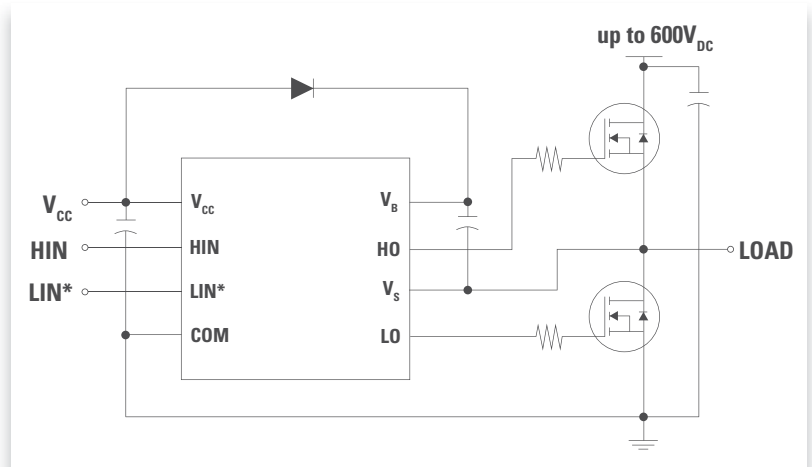

3-Phase Half-Bridge Gate Driver ICs

Switching three pairs of N-Channel MOSFETs or IGBTs in 6-pack configurations is a challenge in fast switching applications. 3-phase gate drivers convert PWM input signals into gate-signals compatible to MOSFETs or IGBTs, providing a robust and efficient power semiconductor control.

Integrated bootstrap circuits are generating floating voltages with enables the three high-side drivers to operate up to $600V_{DC}$.

The drivers accept wide V_{DD} supply voltage as well as wide logic input voltage ranges. Various built-in protection features ensure safe operation of the driver and the driven power semiconductors.

Features & Benefits

- High-side operation up to $600V_{DC}$
- Outputs tolerant to negative transients
- Supply voltage range: 10V to 20V
- Logic input voltage range: 3.3V to 20V
- Cycle-by-cycle edge-triggered shutdown circuitry
- Under Voltage Lockout (UVLO)
- Matched propagation delay times
- Cross conduction prevention logic
- Shoot-through protection logic
- Internal deadtime
- Operating temperature range: $-40^{\circ}C$ to $+125^{\circ}C$

Applications

- 3-Phase Motor Drives
- White Goods
 - Pump Motors
 - Compressor Motors
 - Fan Motors
- Air Conditioners
- Cordless Power Tools
- Robotics



20-Pin
SOIC



28-Pin
SOIC

LF2136 Application Circuit

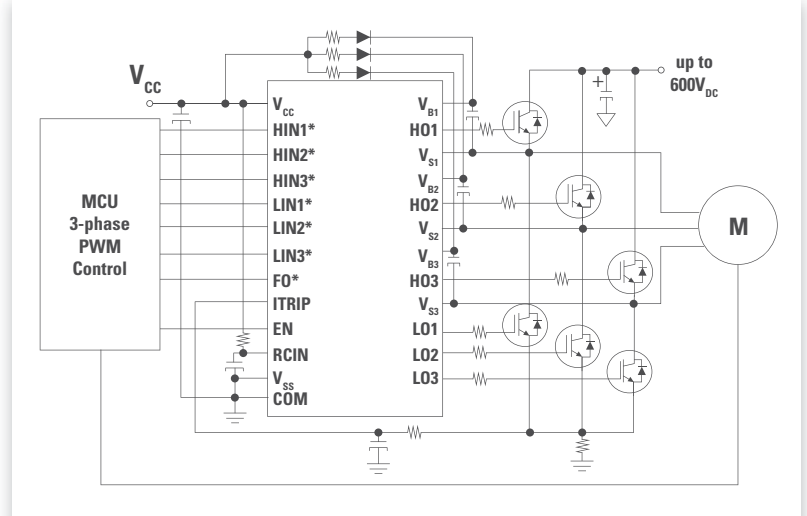

CPC7524: 600V Quad High Voltage Isolated Analog Switch Array

The CPC7524 Quad High Voltage (HV) isolated Analog Switch Array builds upon our high voltage design and fabrication expertise for offline and telecom applications. This monolithic solid state device provides the switching functionality of four normally open (1-Form-A) relays in one small economical package. Designed to provide flexible single-ended or differential access to high voltage networks, the CPC7524 high voltage array is configured as two sets of matched paired switches for improved differential performance. Additionally, sensitive differential applications will benefit from the matched pairs' excellent pair-to-pair isolation. The self-biasing switches do not require external high-voltage supplies for proper operation. Independent switch current limiting and switch-pair thermal shutdown features provide enhanced protection for devices connected to high voltage networks up to +600V.

Features & Benefits

- Provides flexible single-ended or differential access to high voltage networks
- Configured as two sets of matched, paired switches for improved differential performance
- Switch voltage up to 600V_P
- 110dB switch-to-switch isolation at 5kHz
- Flexible switch configurations
- Smart logic for power-up/hot-plug state control
- 3.3V operation with very low power consumption
- Switch current limiting and thermal shutdown protect against fault conditions

Applications

- Instrumentation
- Industrial controls and monitoring
- Automatic test equipment (ATE)
- Battery monitoring and charging circuits
- Worldwide AC mains monitor

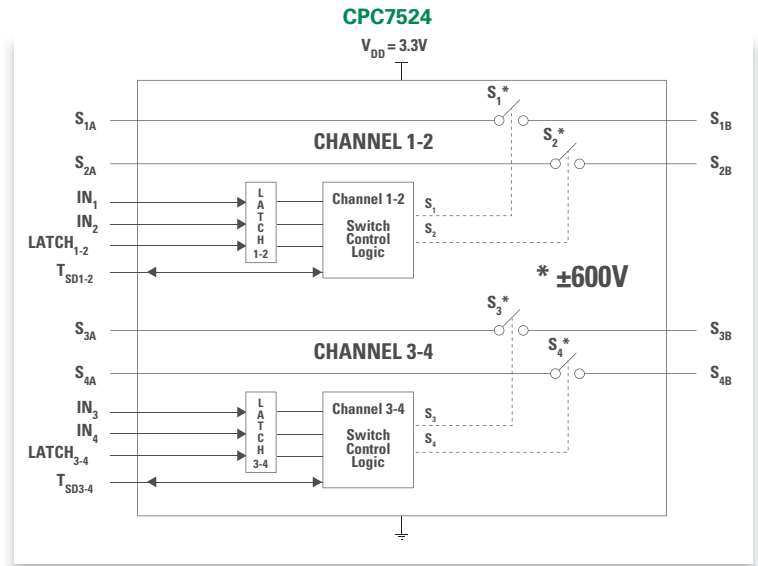

CPC7514: 320V Quad High Voltage Isolated Analog Switch Array

The CPC7514 Quad High Voltage (HV) isolated Analog Switch Array builds upon our Line Card Access Switch (LCAS) design and fabrication expertise for telecom and non-telecom applications. This monolithic solid state device provides the switching functionality of four normally open (1-Form-A) relays in one small economical package. Designed to provide flexible single-ended or differential access to high voltage networks, the CPC7514 high voltage array is configured as two sets of matched paired switches for improved differential performance. Additionally, sensitive differential applications will benefit from the matched pairs' excellent pair-to-pair isolation. The self-biasing switches do not require external high-voltage supplies for proper operation. Independent switch current limiting and switch-pair thermal shutdown features provide enhanced protection for devices connected to high voltage networks up to +320V.

Features & Benefits

- Provides single-ended or differential access to high voltage networks
- Self-biasing – no external high-voltage supplies required
- Low, matched RON
- Switch voltage up to ±320V_P
- 320V logic-input-to-switch-output isolation
- 110dB switch-to-switch isolation at 5kHz
- Flexible switch configurations
- Smart logic for power-up/hot-plug state control
- 3.3V operation with very low power consumption

Applications

- Instrumentation
- Industrial controls and monitoring
- Automatic test equipment (ATE)
- Battery charging circuits
- Telephony
 - VoIP gateways
 - Central office (CO) and remote terminal (RT)
 - Concentrators
 - PBX systems
 - Optical network terminals (ONT)
 - Optical network units (ONU)
 - Hybrid fiber coax (HFC)

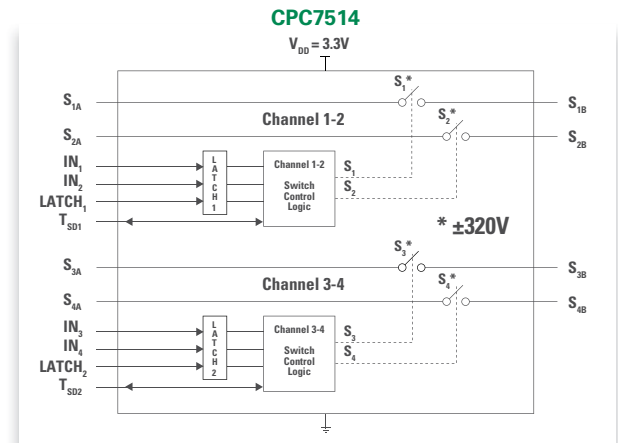

CPC7512: 320V Dual Shunt-Isolated High Voltage High Frequency Analog Switch

The CPC7512 dual 1-Form-A high-voltage, high-frequency, shunt-isolated analog switch builds upon IXYS Integrated Circuits Division's design and fabrication expertise for industrial applications. This monolithic solid state device provides the switching functionality of two normally open (1-Form-A) solid state relays for high frequency applications in one small economical package. Both switches incorporate shunt isolation by means of a T-switch compensation technique to minimize series capacitance through the open off-state switches for improved off-state isolation over frequency. Designed to provide flexible single-ended or differential access to high voltage networks, the CPC7512 is functionally configured as two independent logical switches. The self-biasing switches do not require external high-voltage supplies for proper operation. An integrated thermal shutdown feature provides not only enhanced protection for devices connected to high voltage networks up to +320V, but also an external signal to indicate the device is shut down.

Features & Benefits

- Provides single-ended or differential access to high voltage networks
- Self-biasing: no external high-voltage supplies required
- Low, matched RON
- Guaranteed break-before-make (BBM)
- Switch voltage up to $\pm 320V_p$
- 60dB off-isolation at 1MHz
- Smart logic for power-up/hot-plug state control
- 5V operation with very low power consumption
- Thermal shutdown protects against fault conditions
- Latched TTL logic level inputs

Applications

- Instrumentation
- Industrial controls and monitoring
- Multiplexed ultrasonic transducer switching
- Automatic test equipment (ATE)
- Battery monitoring and charging



20-Pin SOIC

CPC7512

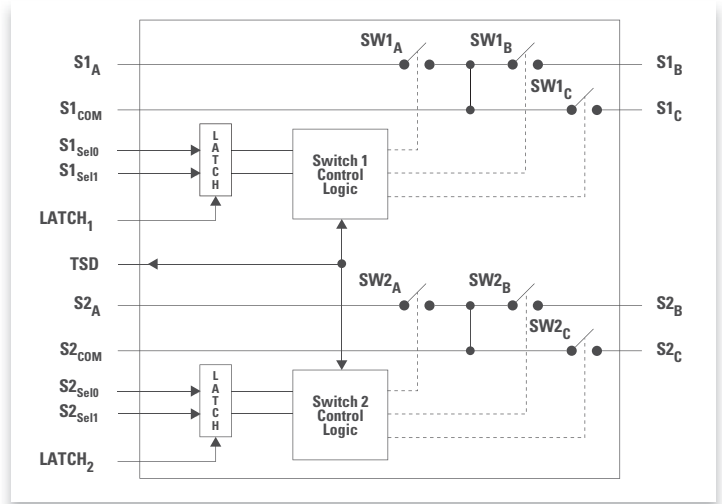

Performance Data

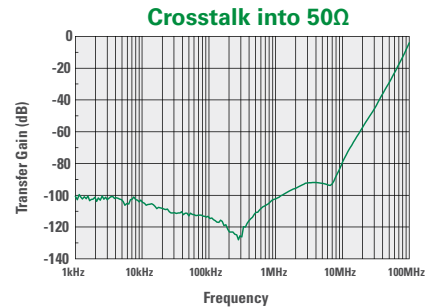
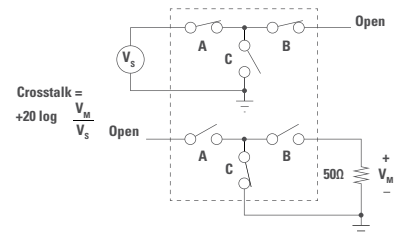
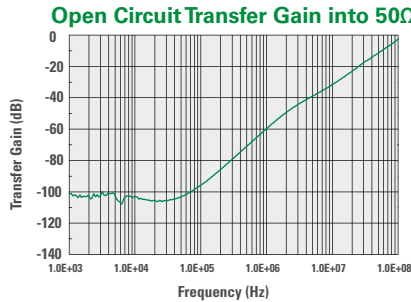
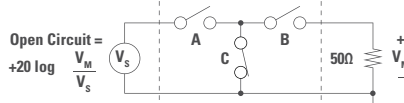
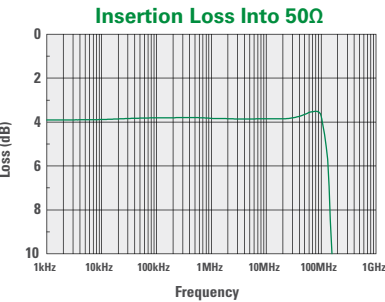
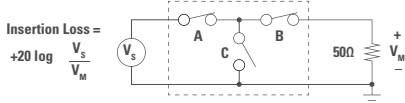

Linear Optocouplers

IXYS IC Division linear optocouplers features an infrared LED optically coupled with two photodiodes. One feedback (input) photodiode is used to generate a control signal that provides a servomechanism to the LED drive current, thus compensating for the LED's nonlinear time and temperature characteristics. The other (output) photodiode provides an output signal that is linear with respect to the servo LED current. The devices feature wide bandwidth, high input to output isolation, and excellent servo linearity.

Features & Benefits

- Couples analog & digital signals
- 3750V_{RMS} input-to-output isolation
- 200kHz bandwidth in photoconductive mode
- 40kHz bandwidth in photovoltaic mode
- High gain stability
- Low input-to-output capacitance
- Low power consumption
- 0.01% servo linearity
- THD 87dB typical

Applications

- Power supply feedback voltage/current
- Industrial and medical sensors
- Isolation of process control transducers
- Isolated 4-20mA converters

Two fundamental operating configurations:

- Photovoltaic Mode:
 - 14-bit linearity
 - 40kHz bandwidth
- Photoconductive Mode:
 - 200kHz bandwidth
 - 8-bit linearity

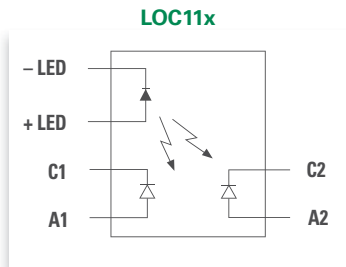

8-Pin DIP



8-Pin Surface Mount



8-Pin Flatpack

Note – Images are to scale

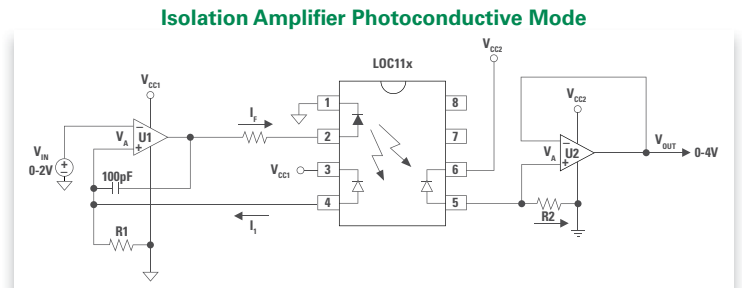
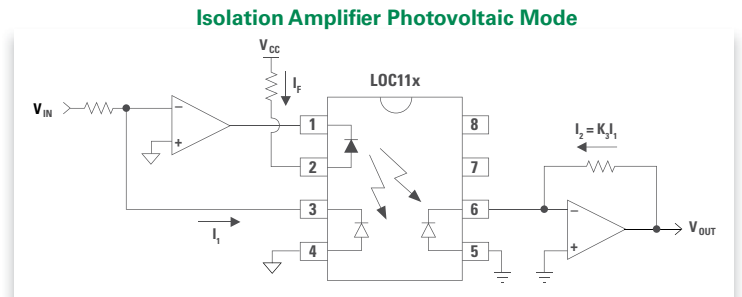

Single Optocouplers

Optocouplers provide an optically means of switching control circuits. The package contains a phototransistor that is optically coupled with a LED. A shunt resistor can be used to adjust the threshold current required to activate the output circuitry.

Optocouplers are ideal for Telecom, Industrial Control and instrumentation circuits, where electrical isolation of control circuitry is crucial.

Features & Benefits

- 100mA continuous load rating
- Breakdown voltage: 30V
- Minimum current transfer ratio: 100%
- 1500V_{RMS} Input/Output isolation
- 4-pin SOP package

Applications

- Logic signal isolation
- Sensor circuitry
- Instrumentation
- Industrial control



4-Pin SOP

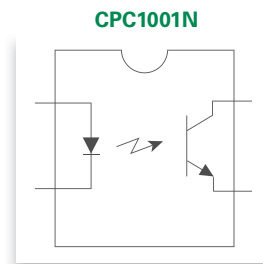

N-Channel Depletion Mode MOSFETs

IXYS Integrated Circuits' N-channel depletion mode field effect transistors (FET) utilize a proprietary third generation vertical DMOS process which realizes world-class, high voltage MOSFET performance in an economical silicon gate process. The vertical DMOS process yields a robust device for high power applications with high input impedance. These highly reliable FET devices have been used extensively in our solid state relays for industrial and telecommunications applications.

Features & Benefits

- Normally closed depletion mode devices offer low $R_{D(S(on))}$ at cold temperatures
- High input impedance
- Low input capacitance
- Fast switching speeds
- Low input and output leakage

Applications

- Power fail switches
- Discrete normally closed relays
- Constant current, high brightness LED drivers
- High voltage pre-regulators
- Power inverters
- Power supplies

Depletion Mode MOSFET

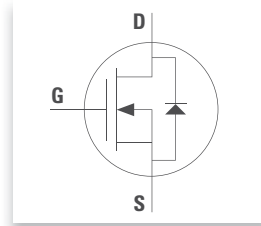

FDA217 used with CPC3980 MOSFETs to create Normally Closed Solid State Relay

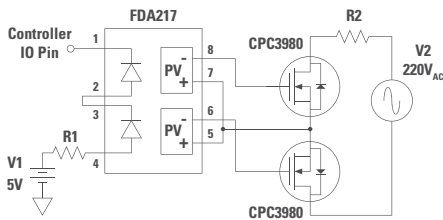

High Voltage Off-line Linear Voltage Regulator

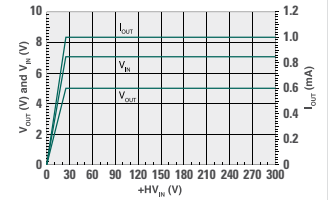
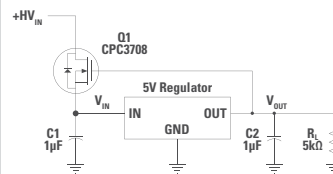

N-Channel Depletion Mode MOSFET as Pre-Regulator

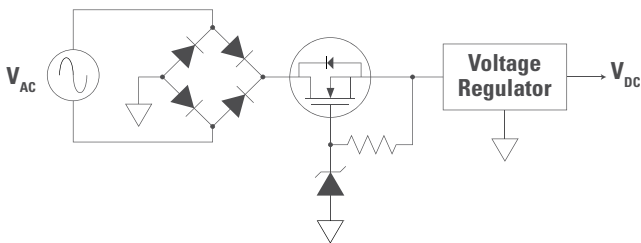

High Voltage Ramp Generator

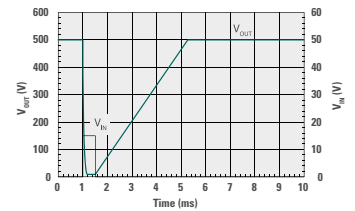
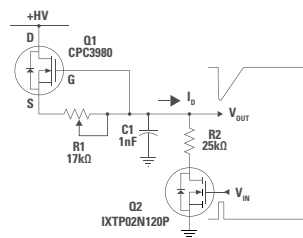

SOT-23



SOT-89



SOT-223

Note – Images are to scale

NCD2400M: Wide Capacitance Range, Non-volatile, Digital Programmable Capacitor

The NCD2400M is a dedicated electronic calibrator for oscillators, with reliable performance at 105°C as required by OCXO applications. This product can be used in series or shunt configuration, to support a wide variety of tuning circuit topologies. Digitally controlled capacitance trimming information is communicated via a 2-wire (I²C compatible) interface. The calibration value can be stored in the internal, re-programmable, non-volatile memory.

Features & Benefits

- Series and shunt configurations supported:
 - $C_{shunt} = 12.5\text{pF}$ to 194pF in discrete 355fF steps
 - $C_{series} = 1.7\text{pF}$ to 194pF in discrete 376fF steps
- 512-state digital programmable capacitor
- Operating frequency range of DC to 150MHz
- Operation at 105°C
- 2-wire (I²C compatible) serial interface
- EEPROM non-volatile memory
- 2.5V to 5.5V Input Supply Voltage Range
- 2mm x 2mm (DFN-6)

Applications

- VCXOs
- Crystal oscillators
- Tunable RF stages
- RFID tags
- Industrial wireless control
- Capacitor sensor trimming

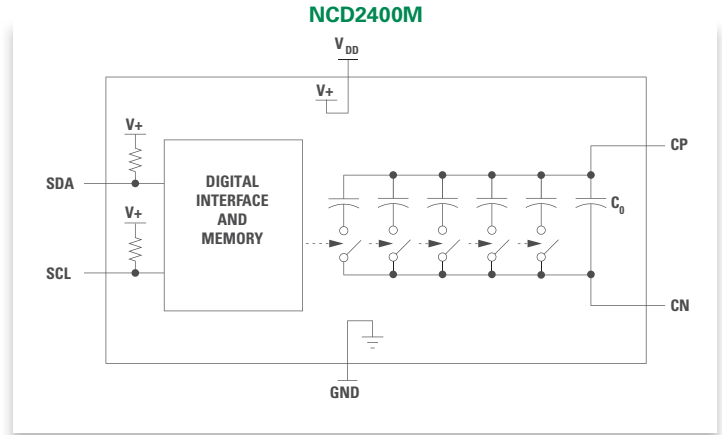

NCD2100: Non-Volatile Digital Programmable Capacitor

The NCD2100 is an EEPROM-based digitally programmable variable capacitor that provides capacitive offset trimming for capacitance sensitive circuits. Programming the non-volatile EEPROM register value or implementing on demand capacitance value changes are easily accomplished by means of the simple two-wire serial bus. To ensure interoperability over a broad array of design environments, the device is rated for operation with supply voltages of 2.5V to 5.5V across the temperature range of -40°C to +85°C.

Features & Benefits

- Capacitance range 6.6pF to 37.553pF
- 1024 programmable capacitance values
- Operating frequency range 200kHz to 250MHz
- Smallest capacity step size: 63fF
- 2mm x 2mm (DFN-6), 2.9mm x 2.8mm (TSOT-6)

Applications

- VCXOs
- Crystal oscillators
- Tunable RF stages
- RFID tags
- Industrial wireless control
- Capacitor sensor trimming

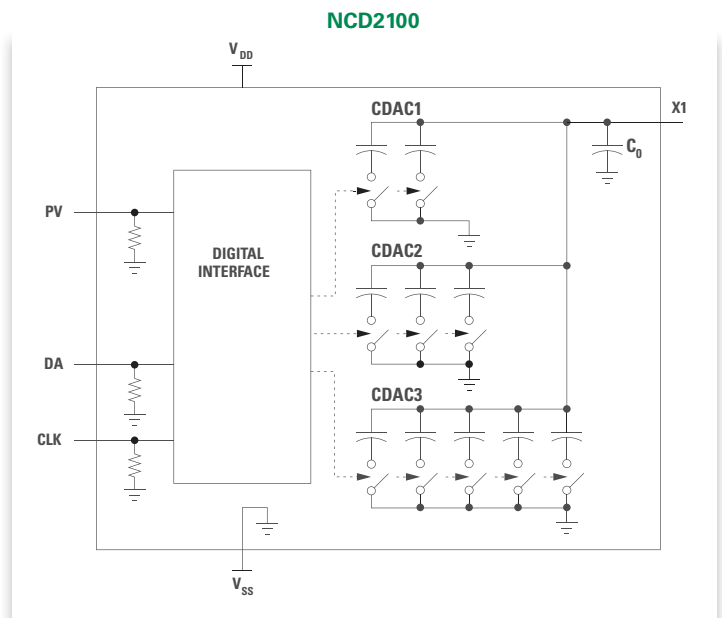

DFN-6



TSOT-6

Note – Images are to scale

CPC9909: High Efficiency, High Brightness Mains-Powered LED Driver

The CPC9909 high-efficiency, high-brightness LED driver is manufactured in a high voltage BCDMOS on SOI process. The wide input operating voltage range from $8V_{DC}$ to $550V_{DC}$ enables the device to be used in a broad range of high-brightness LED applications. The device features pulse frequency modulation (PFM) with a constant peak-current control scheme. This regulation scheme is inherently stable, allowing the driver to be operated above 50% duty cycle without open loop instability or sub-harmonic oscillations. LED dimming can be implemented by applying a small DC voltage to the LD pin, or by applying a low frequency PWM signal to the PWMD pin.

Features & Benefits

- 8V to 550V input voltage range
- Linear or PWM brightness control inputs
- Drives multiple LEDs in series/parallel
- >90% efficiency
- Stable operation at >50% duty cycle
- Regulated LED current
- Resistor-programmable minimum off-time
- Drives external power MOSFET, enabling high LED output current applications
- Buck or boost configuration

Applications

- Flat-panel display RGB backlighting
- Signage and decorative LED lighting
- DC/DC or AC/DC LED driver applications

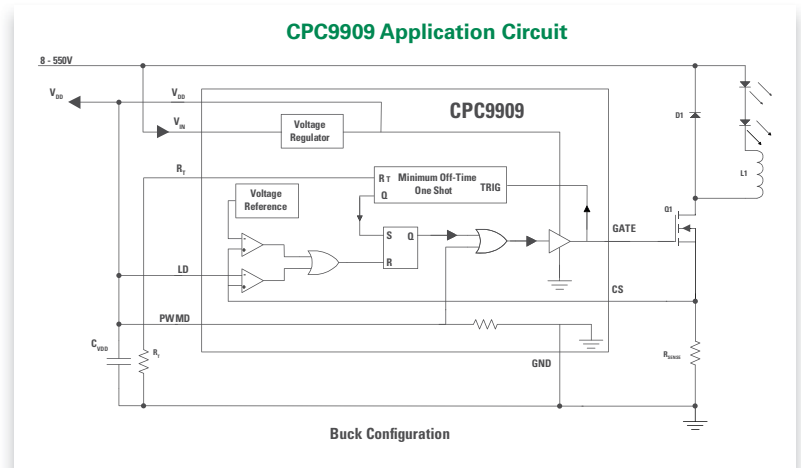

MXHV9910: High Voltage, Mains-Powered LED Driver

The MXHV9910 high-efficiency, high-brightness LED driver is manufactured in a high voltage BCDMOS on SOI process. The wide input operating voltage range from $8V_{DC}$ to $450V_{DC}$ enables the device to be used in a broad range of high-brightness LED applications. The MXHV9910 features a fixed-frequency, peak-current control method, which provides an ideal solution for driving multiple LEDs in series and in parallel. LED dimming can be implemented by applying a small DC voltage to the LD pin, or by applying a low frequency PWM signal to the PWMD pin.

Features & Benefits

- 8V to 450V input voltage range
- >90% efficiency
- Drives multiple LEDs in series/parallel combinations
- Regulated LED drive current
- Linear or PWM brightness control inputs
- Resistor-programmable oscillator frequency

Applications

- Signage, decorative LED lighting
- Flat-panel display RGB backlighting
- DC & AC/DC LED driver applications

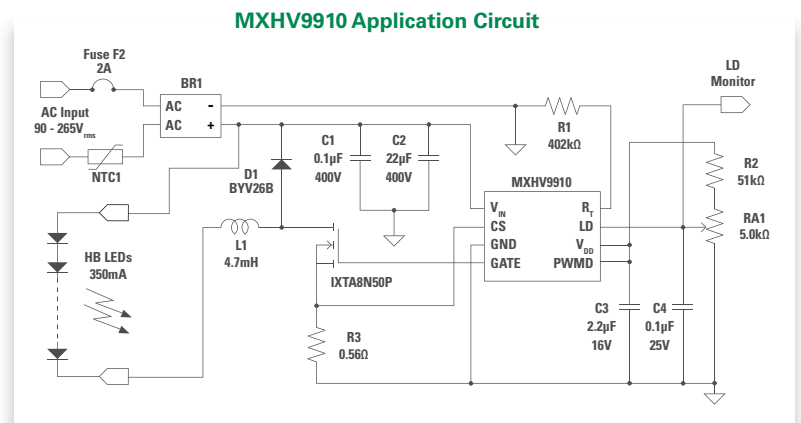

Note – Images are to scale

Multifunction Products: SSR/Optocouplers

General Purpose Multifunction Products

The OptoMOS® line of Multifunction Products combines a number of discrete, optically isolated functions into a single package. These products mix and match solid state relays, optocouplers, and Darlington transistors to create highly functional circuits in a single, small package. Multifunction devices allow designers to consolidate circuit functions into a single device, thus freeing up valuable board space and reducing component count.

Features & Benefits

- 3750V_{RMS} input-to-output isolation
- Multiple functionality in a single package
- Current limiting (part numbers with "L" suffix)

Applications

- Telecommunication/datacommunication
- Instrumentation
- I/O subsystems/electronic switching
- Medical equipment (patient/equipment isolation)
- Security

Available Multifunction Product Configurations

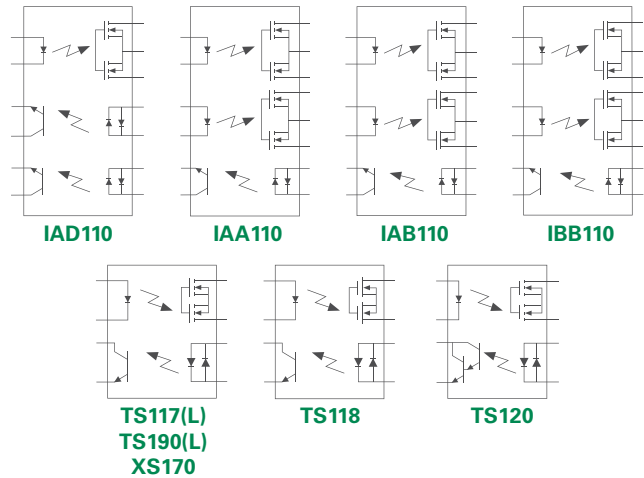

Telecommunications Multifunction Products

Multifunction devices allow designers to consolidate circuit functions into a single device, freeing up valuable board space and reducing component count. Designed specifically for the telecommunications industry, the Integrated Telecom Circuit (ITC) series is well suited for voice telephony and modem applications, providing most of the major functions required when designing DAA (Data Access Arrangement) or voice (FXO) line interface circuits. Available in a 16-pin SOIC package.

Features & Benefits

- 3750V_{RMS} input-to-output isolation
- Multiple functionality in a single package
- Current limiting (part numbers with "L" suffix)

Applications

- Telecommunication/datacommunication
- Instrumentation
- I/O subsystems
- Electronic switching
- Medical equipment (patient/equipment isolation)
- Security
- Industrial controls

Available Integrated Telecom Circuit Versions

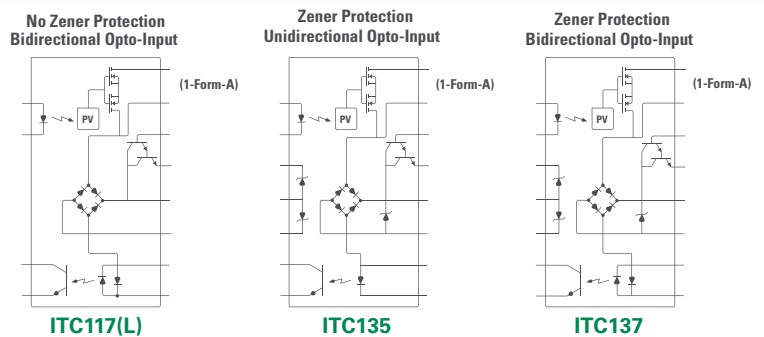

8-Pin
DIP



8-Pin
Flatpack



8-Pin
Surface
Mount



16-Pin
SOIC

Note – Images are to scale

Voltage Monitoring & Sensing IC

CPC5712

The CPC5712 is a special purpose Voltage Monitor with Detectors integrated circuit that is used in various high-voltage telephony applications such as VoIP gateways and IP-PBXs. The device monitors the TIP/RING potential through a high-impedance divider (resistor isolation) to derive two programmable signal level detects, polarity information, and a scaled representation of the phone line voltages. In use, the resistor divider and the high input impedance of the CPC5712 make the circuit practically undetectable on the line.

The CPC5712 can also be used in non-telephony applications including instrumentation and industrial controls. It is virtually undetectable in use.

Features & Benefits

- Derives two voltage level detectors, polarity information, and a scaled, linear representation of the phone line voltages
- 2 independent, programmable level-detectors with programmable hysteresis
- Fixed-level polarity detector with hysteresis
- Differential linear output
- Common-Mode Rejection Ratio (CMRR) >55dB
- Worldwide telephone network compatibility
- High differential input impedance, very low common-mode input impedance
- Fixed gain, 3V to 5.5V operation
- CMOS logic level output (TTL compatible)

Applications

- Special-purpose "Voltage Monitor with Detectors" integrated circuit used in high voltage telephony applications
- VoIP gateways, IP-PBX, xDSL
- Non-telephony applications include instrumentation and industrial controls; virtually undetectable in use
- TIP/RING monitoring: polarity detection for caller ID, enhanced 911, line-in-use, battery detection, PSTN check



16-Pin SOP

CPC5712 Application Circuit

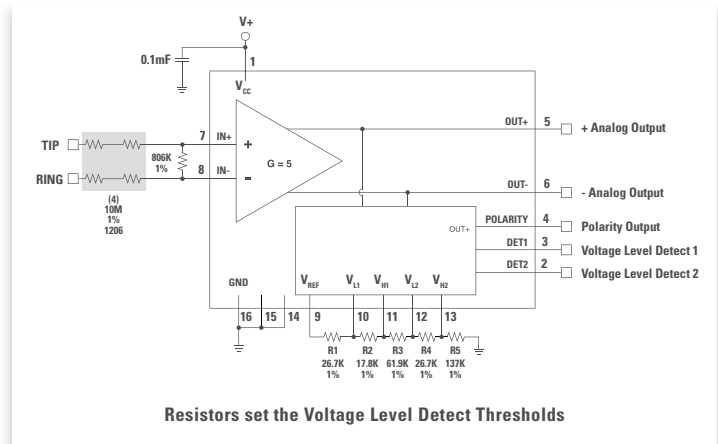

CPC5622-EVAL-600R Evaluation Board

The evaluation board ships with the CPC5622A LITELINK III and CPC5712U Voltage Monitor to demonstrate the functionality of a PSTN terminating two-wire interface that provides both the analog voice transmission and signaling functions. The analog interface is configured to provide a 600 Ohms resistive AC impedance with 0dB gain in both the transmit and receive directions.

While the CPC5622A provides the hook-switch and ringing detect signaling functions, the CPC5712U is utilized to monitor and detect changes in the DC line voltage to determine loop status and signaling information sent by the network. Loop status is given by the logic level outputs of the three CPC5712U on-board detectors indicating Loop Presence, Line In Use, and Loop Polarity.



Solid State Relays



4-Pin SOP

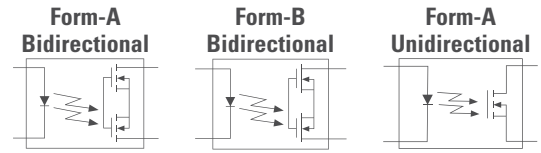

Part Number	Relay Type	Blocking Voltage (V _p)	Load Current (mA)	On Resistance (Ω)	Input Control Current (mA)	Switching Speeds t _{on} / t _{off} (ms)	Isolation Voltage (V _{RMS})	Off-State Leakage (μA)	Features & Comments
1-Form-A Relays: Single-Pole									
CPC1225N	BI	400	120	30	2	2 / 1	1500	1	IEC/EN/UL 62368-1 Supplementary Insulation (0.4mm distance through insulation)
CPC1025N		400	120	30	2	2 / 1	1500	1	-
CPC1230N		350	120	30	2	2 / 1	1500	1	IEC/EN/UL 62368-1 Supplementary Insulation (0.4mm distance through insulation)
CPC1030N		350	120	30	2	2 / 1	1500	1	-
CPC1035N		350	100	35	2	2 / 1	1500	1	-
CPC1010N		250	170	11.5	2	3 / 3	1500	1	-
CPC1008N		100	150	8	2	2 / 1	1500	1	-
CPC1009N		100	150	8	2	2 / 0.5	1500	0.02	Very low off-state I _{LEAK} ≤ 20nA
CPC1016N		100	100	16	2	2 / 1	1500	1	-
CPC1019N		60	750	0.6	2	3 / 3	1500	1	-
CPC1018N		60	600	0.8	1	3 / 2	1500	1	-
CPC1014N		60	400	2	2	2 / 1	1500	1	EN 50130-4
CPC1017N		60	100	16	1	10 / 10	1500	1	Low I _F , EN 50130-4
CPC1006N		60	75	10	0.5	10 / 10	1500	1	Low I _F , EN 50130-4
CPC1020N	30	1200	0.25	2	3 / 3	1500	1	High load current, very low on-resistance	
1-Form-B Relays: Single-Pole									
CPC1125N	BI	400	100	35	2	2 / 2	1500	5	-
CPC1150N		350	120	50	2	1 / 2	1500	5	-
CPC1135N		350	120	35	2	2 / 2	1500	5	-
CPC1231N		350	120	30	2	2 / 2	1500	5	IEC/EN/UL 62368-1 Supplementary Insulation (0.4mm distance through insulation)
CPC1130N		350	120	30	2	2 / 2	1500	5	-
CPC1114N		60	400	2	2	2 / 5	1500	1	-
CPC1117N		60	150	16	1	10 / 10	1500	1	Low I _F , EN 50130-4
CPC1106N		60	75	10	0.5	10 / 10	1500	1	Low I _F , EN 50130-4
1-Form-A Relays: Single-Pole, Unidirectional (DC-only)									
CPC1004N	UNI	100	300	4	2	3 / 1	1500	1	Extended operating temperature range: -40°C to +110°C
CPC1002N		60	700	0.55	2	5 / 2	1500	1	EN 50130-4

Motion Detection

ZMOTIONL400 PIR Motion Detection MCU Development Kit

The ZMOTIONL400 PIR Motion Detection Development Kit provides an excellent platform for evaluating the capabilities of our ZMOTION Family of PIR Sensors, Motion Detection Microcontrollers, and related ZMOTION Engine Software. The ZMOTION Family is ideally suited for most motion detection applications including lighting control, IP cameras and intrusion/security motion detectors in both wired and battery powered products.

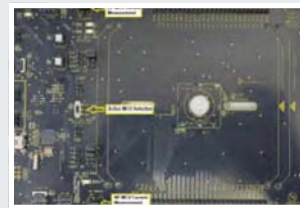

Scan the code to learn more.

Solid State Relays



6-Pin Surface Mount

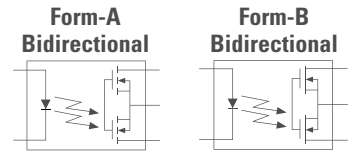

Part Number	Relay Type	Blocking Voltage (V _P)	Load Current (mA)	On Resistance (Ω)	Input Control Current (mA)	Switching Speeds t _{on} / t _{off} (ms)	Isolation Voltage (V _{RMS})	Off-State Leakage (μA)	Features & Comments
1-Form-A Relays: Single-Pole									
PLA170S	BI+	800	100	50	5	5 / 5	3750	1	-
PLA192S		600	150	22	5	5 / 5	5000	1	Enhanced isolation voltage
PLA194S		600	130	35	2	3 / 2	5000	1	Enhanced isolation voltage
CPC1593GS		600	120	35	2	2 / 2	3750	1	-
CPC1563GS		600	120	35	2	2 / 2	3750	1	-
PLA193S		600	100	50	5	5 / 5	5000	1	Enhanced isolation voltage
PLA143S		600	100	50	2	5 / 5	4000	1	Enhanced isolation voltage
PLA191S		400	250	8	5	3 / 1	5000	1	Enhanced isolation voltage
PLA140S		400	250	8	5	3 / 1	3750	1	-
PLA140LS		400	200	13	5	5 / 3	3750	1	Current limiting
PLA110LS		400	150	25	5	1 / 0.5	3750	1	Current limiting
PLA190S		400	150	22	5	1 / 0.5	5000	1	Enhanced isolation voltage
PLA110S		400	150	22	5	1 / 0.5	3750	1	-
LCA182S		350	120	35	0.25	3 / 3	3750	1	Very low I _F
LCA110S		350	120	35	2	3 / 3	3750	1	-
LCA110LS		350	120	35	2	3 / 3	3750	1	Current limiting
CPC1540GS		350	120	25	2	2 / 2	3750	1	Current limiting, thermal management, voltage triggered shutdown
LCA100LS		350	120	25	5	5 / 5	3750	1	Current limiting
LCA100S		350	120	25	5	5 / 5	3750	1	-
XCA170S		350	100	50	5	5 / 5	3750	1	-
LCA125LS		300	170	20	5	5 / 5	3750	1	Current limiting
LCA125S		300	170	16	5	5 / 5	3750	1	-
PLA160S		300	50	100	10	0.05 / 0.05	3750	0.025	-
PLA150S		250	250	7	5	2.5 / 0.5	3750	1	-
CPC1510GS		250	200	15	2	2 / 2	3750	1	Current limiting with thermal management
LCA127S		250	200	10	5	5 / 5	3750	1	-
LCA129S		250	170	20	2	8 / 8	3750	1	-
LCA120S		250	170	20	5	3 / 3	3750	1	-
LCA127LS		250	170	15	5	5 / 5	3750	1	Current limiting
LCA120LS		250	150	20	5	3 / 3	3750	1	Current limiting
OMA160S		250	50	100	10	0.125 / 0.125	3750	0.025	Low I _{LEAK} , fast switching speeds
LCA701S		100	1500	0.3	2	4 / 1	3750	1	High load current
PLA134S	100	350	3	5	5 / 5	3750	1	-	
LCA715S	60	2200	0.15	5	2.5 / 0.25	3750	1	High load current	
LCA712S	60	1000	0.5	10	2.5 / 0.35	3750	0.01	High load current, low I _{LEAK}	
LCA710S	60	1000	0.5	10	2.5 / 0.25	3750	1	High load current	
PLA132S	60	600	1	2	5 / 2	3750	1	-	
LCA717S	30	2000	0.15	2	3 / 3	3750	1	High load current	
1-Form-B Relays: Single-Pole									
PLB190S	BI+	400	130	25	2	1 / 2.5	5000	1	-
LCB111S		350	120	35	2	5 / 5	3750		-
LCB110S		350	120	35	5	3 / 3	3750		-
XCB170S		350	100	50	5	5 / 5	3750		-
PLB150S		250	250	7	5	1 / 2.5	3750		-
LCB127S		250	200	10	5	5 / 5	3750		-
LCB120S		250	170	20	5	5 / 5	3750		-
LCB126S		250	170	15	5	5 / 5	3750		-
LCB710S		60	1000	0.6	2	3 / 3	3750		High load current
LCB716S		60	500	2	2	3 / 3	3750		-
LCB717S		30	1500	0.3	2	2 / 5	3750		High load current

Solid State Relays



6-Pin DIP

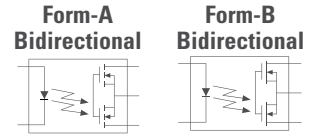

Part Number	Relay Type	Blocking Voltage (V _p)	Load Current (mA)	On Resistance (Ω)	Input Control Current (mA)	Switching Speeds t _{on} / t _{off} (ms)	Isolation Voltage (V _{RMS})	Off-State Leakage (μA)	Features & Comments
1-Form-A Relays: Single-Pole									
PLA170	BI+	800	100	50	5	5 / 5	3750	1	-
PLA192		600	150	22	5	5 / 5	5000	1	Enhanced isolation voltage
PLA194		600	130	35	2	3 / 2	5000	1	Enhanced isolation voltage
CPC1593G		600	120	35	2	2 / 2	3750	1	Current limiting, thermal management, voltage triggered shutdown
CPC1563G		600	120	35	2	2 / 2	3750	1	Current limiting, thermal management, voltage triggered shutdown
PLA143		600	100	50	2	5 / 5	4000	1	Enhanced isolation voltage
PLA193		600	100	50	5	5 / 5	5000	1	Enhanced isolation voltage
PLA110L		400	150	25	5	1 / 0.5	3750	1	Current limiting
PLA190		400	150	22	5	1 / 0.5	5000	1	Enhanced isolation voltage
PLA110		400	150	22	5	1 / 0.5	3750	1	-
LCA110		350	120	35	2	3 / 3	3750	1	-
LCA110L		350	120	35	2	3 / 3	3750	1	Current limiting
CPC1540G		350	120	25	2	2 / 2	3750	1	Current limiting, thermal management, voltage triggered shutdown
LCA182		350	120	35	0.25	3 / 3	3750	1	Very low I _F
LCA100		350	120	25	5	5 / 5	3750	1	-
LCA100L		350	120	25	5	5 / 5	3750	1	Current limiting
XCA170		350	100	50	5	5 / 5	3750	1	-
PLA160		300	50	100	10	0.05 / 0.05	3750	0.025	Low I _{LEAK} , fast switching speeds
CPC1510G		250	200	15	2	2 / 2	3750	1	Current limiting with thermal management
LCA120L		250	150	20	5	3 / 3	3750	1	Current limiting
OMA160	250	50	100	10	0.125 / 0.125	3750	0.025	Low I _{LEAK} , fast switching speeds	
1-Form-A Relays: Single-Pole									
PLA191	BI+	400	250	8	5	3 / 1	3750	1	Enhanced isolation voltage
PLA140		400	250	8	5	3 / 1		1	-
PLA140L		400	200	13	5	5 / 3		1	Current limiting
LCA125L		300	170	20	5	5 / 5		1	Current limiting
LCA125		300	170	16	5	5 / 5		1	-
PLA150		250	250	7	5	2.5 / 0.5		1	-
LCA127		250	200	10	5	5 / 5		1	-
LCA129		250	170	20	2	8 / 8		1	-
LCA120		250	170	20	5	3 / 3		1	-
LCA127L		250	170	15	5	5 / 5		1	-
LCA701		100	1500	0.3	2	4 / 1		1	High load current
PLA134		100	350	3	5	5 / 5		1	-
LCA715		60	2200	0.15	5	2.5 / 0.25		1	-
LCA712		60	1000	0.5	10	2.5 / 0.35		0.01	High load current, low I _{LEAK}
LCA710		60	1000	0.5	10	2.5 / 0.25		1	High load current
PLA132		60	600	1	2	5 / 2		1	-
LCA717		30	2000	0.15	2	3 / 3		1	-
1-Form-B Relays: Single-Pole									
PLB190	BI+	400	130	25	2	1 / 2.5	5000	1	-
LCB110		350	120	35	5	3 / 3	3750		-
XCB170		350	100	50	5	5 / 5	3750		-
LCB111		350	120	35	2	5 / 5	3750		-
LCB120		250	170	20	5	5 / 5	3750		-
LCB126		250	170	15	5	5 / 5	3750		-
LCB127		250	200	10	5	5 / 5	3750		-
PLB150		250	250	7	5	1 / 2.5	3750		-
LCB716		60	500	2	2	3 / 3	3750		-
LCB710		60	1000	0.6	2	3 / 3	3750		High load current
LCB717		30	1500	0.3	2	2 / 5	3750		High load current

Solid State Relays



4-Pin DIP

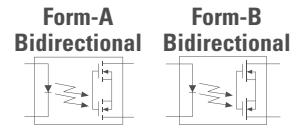

Part Number	Relay Type	Blocking Voltage (V _p)	Load Current (mA)	On Resistance (Ω)	Input Control Current (mA)	Switching Speeds t _{on} / t _{off} (ms)	Isolation Voltage (V _{RMS})	Off-State Leakage (μA)	Features & Comments
1-Form-A Relays: Single-Pole									
CPC1394G	BI	600	120	35	2	5 / 3	5000	1	Enhanced isolation voltage
CPC1393G		600	90	50		5 / 5			
CPC1390G		400	140	22		1 / 1			
CPC1330G		350	120	30		2 / 1			
1-Form-B Relays: Single-Pole									
CPC1333G	BI	350	130	30	2	2 / 3	5000	1	Enhanced isolation voltage



4-Pin Surface Mount

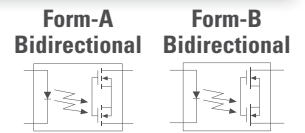

Part Number	Relay Type	Blocking Voltage (V _p)	Load Current (mA)	On Resistance (Ω)	Input Control Current (mA)	Switching Speeds t _{on} / t _{off} (ms)	Isolation Voltage (V _{RMS})	Off-State Leakage (μA)	Features & Comments
1-Form-A Relays: Single-Pole									
CPC1394GR	BI	600	120	35	2	5 / 3	5000	1	Enhanced isolation voltage
CPC1393GR		600	90	50		5 / 5			
CPC1390GR		400	140	22		1 / 1			
CPC1330GR		350	120	30		2 / 1			
1-Form-B Relays: Single-Pole									
CPC1333GR	BI	350	130	30	2	2 / 3	5000	1	Enhanced isolation voltage



4-Pin V-DIP

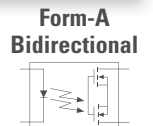

Part Number	Relay Type	Blocking Voltage (V _p)	Load Current (mA)	On Resistance (Ω)	Input Control Current (mA)	Switching Speeds t _{on} / t _{off} (ms)	Isolation Voltage (V _{RMS})	Off-State Leakage (μA)	Features & Comments
1-Form-A Relays: Single-Pole									
CPC1393GV	BI	600	90	50	2	5 / 5	5000	1	Enhanced isolation voltage
CPC1394GV		600	120	35		5 / 3			
CPC1390GV		400	140	22		1 / 1			



6-Pin Flatpack (8-Pin Body)

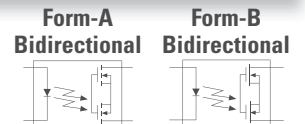

Part Number	Relay Type	Blocking Voltage (V _p)	Load Current (mA)	On Resistance (Ω)	Input Control Current (mA)	Switching Speeds t _{on} / t _{off} (ms)	Isolation Voltage (V _{RMS})	Off-State Leakage (μA)	Features & Comments
1-Form-A Relays: Single-Pole									
PLA172P	BI	800	100	50	2	5 / 5	5000	1	-40°C to +105°C Operational Temperature Range
PLA171P									Enhanced isolation voltage, high blocking voltage (output pins 7mm separation)
1-Form-B Relays: Single-Pole									
PLB171P	BI	800	80	55	2	5 / 5	5000	1	Enhanced isolation voltage, high blocking voltage (output pins 7mm separation)

Solid State Relays



8-Pin Flatpack

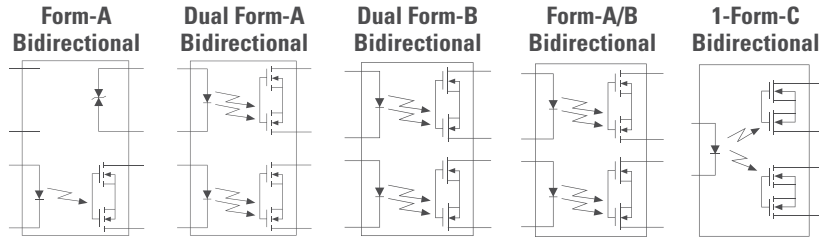

Part Number	Relay Type	Blocking Voltage (V _P)	Load Current (mA)	On Resistance (Ω)	Input Control Current (mA)	Switching Speeds t _{on} / t _{off} (ms)	Isolation Voltage (V _{RMS})	Off-State Leakage (μA)	Features & Comments
1-Form-A Relays: Single-Pole									
CPC1335P	BI	350	100	35	1	10 / 10	3750	1	Low I _E , EN 50130-4 (installation class 3), transient voltage suppression (TVS)
1-Form-A Relays: Dual Single-Pole									
PAA140P	BI	400	250	8	5	3 / 1	3750	1	-
PAA110PL		400	150	25	5	1 / 0.5		1	Current limiting
PAA110P		400	150	22	5	1 / 0.25		1	-
LAA125P		350	170	16	5	5 / 5		1	-
LAA125PL		350	150	18	5	5 / 5		1	Current limiting
LAA110P		350	120	35	5	3 / 3		1	-
LAA110PL		350	120	35	5	3 / 3		1	Current limiting
LAA100PL		350	120	25	5	5 / 5		1	Current limiting
LAA100P		350	120	25	5	5 / 5		1	-
XAA170P		350	100	50	5	5 / 5		1	-
PAA127P		280	200	10	3	0.5 / 0.5		0.025	Very low I _{LEAK} , fast switching speeds
LAA120PL		250	150	25	5	5 / 5		1	Current limiting
OAA160P		250	50	100	6	0.125 / 0.125		0.025	Very low I _{LEAK} , fast switching speeds
LAA120P		250	170	20	5	5 / 5		1	-
LAA127PL		250	170	10	5	5 / 5		1	Current limiting
LAA127P		250	200	10	5	5 / 5		1	-
PAA150P		250	250	7	5	2.5 / 0.5		1	-
LAA108P		100	300	8	2	3 / 3		1	-
XAA117P	60	150	16	1	5 / 5	1	Low I _F		
1-Form-B Relays: Dual Single-Pole									
LBB110P	BI	350	120	35	5	3 / 3	3750	1	-
XBB170P		350	100	50		5 / 5			-
PBB150P		250	250	7		2.5 / 2.5			-
LBB127P		250	200	10		5 / 5			-
LBB126P		250	170	15		5 / 5			-
LBB120P		250	170	20		5 / 5			-
1-Form-A & 1-Form B Combination Relays									
LBA110P	BI	350	120	35	2	3 / 3	3750	1 / 1	-
LBA110PL		350	120	35	5	3 / 3			Current limiting
LBA127P		250	200	10	5	5 / 5			-
LBA120P		250	170	20	5	5 / 5			-
1-Form-C Relays: Common Input, Single-Pole, Double-Throw									
LCC110P	BI	350	120	35	8	4 / 4	3750	1	-

Solid State Relays



8-Pin DIP

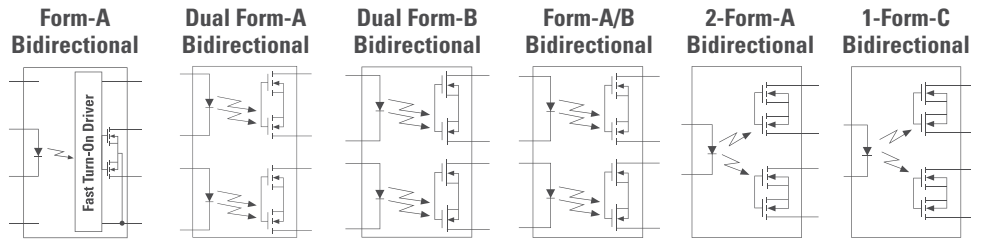

Part Number	Relay Type	Blocking Voltage (V _p)	Load Current (mA)	On Resistance (Ω)	Input Control Current (mA)	Switching Speeds t _{on} / t _{off} (ms)	Isolation Voltage (V _{RMS})	Off-State Leakage (μA)	Features & Comments
1-Form-A Relays: Single-Pole									
CPC1560	BI+	60	300	5.6	1.1	0.1 / 0.4	3750	1	Current limiting with thermal management
1-Form-A Relays: Dual Single-Pole									
PAA193	BI	600	100	50	5	5 / 5	5000	10	Enhanced isolation voltage
PAA191		400	250	8	5	3 / 1	5000	1	Enhanced isolation voltage
PAA140		400	250	8	5	3 / 1	3750	1	-
PAA140L		400	200	13	5	5 / 3	3750	1	Current limiting
PAA110L		400	150	25	5	1 / 0.5	3750	1	Current limiting
PAA190		400	150	22	5	1 / 0.5	5000	1	Enhanced isolation voltage
PAA110		400	150	22	5	1 / 0.25	3750	1	-
LAA125		350	170	16	5	5 / 5	3750	1	-
LAA125L		350	150	18	5	5 / 5	3750	1	Current limiting
LAA110L		350	120	35	5	3 / 3	3750	1	Current limiting
LAA110		350	120	35	5	3 / 3	3750	1	-
LAA100		350	120	25	5	5 / 5	3750	1	-
LAA100L		350	120	25	5	5 / 5	3750	1	Current limiting
XAA170		350	100	50	5	5 / 5	3750	1	-
PAA127		280	200	10	3	0.5 / 0.5	3750	0.025	Very low I _{LEAK} , fast switching speeds
PAA150		250	250	7	5	2.5 / 0.5	3750	1	-
LAA127		250	200	10	5	5 / 5	3750	1	-
LAA120		250	170	20	5	5 / 5	3750	1	-
LAA127L		250	170	10	5	5 / 5	3750	1	Current limiting
LAA120L		250	150	25	5	5 / 5	3750	1	Current limiting
OAA160	250	50	100	6	0.125 / 0.125	3750	0.025	Very low I _{LEAK} , fast switching speeds	
LAA108	100	300	8	2	3 / 3	3750	1	-	
LAA710	60	1000	0.5	10	2.5 / 0.25	3750	1	-	
PAA132	60	600	1	2	5 / 2	3750	1	-	
XAA117	60	150	16	1	5 / 5	3750	1	Low I _F	
1-Form-B Relays: Dual Single-Pole									
PBB190	BI	400	130	25	2	1 / 2.5	5000	1	-
XBB170		350	100	50	5	5 / 5	3750		-
LBB110		350	120	35	5	3 / 3	3750		-
PBB150		250	250	7	5	2.5 / 2.5	3750		-
LBB127		250	200	10	5	5 / 5	3750		-
LBB120		250	170	20	5	5 / 5	3750		-
LBB126		250	170	15	5	5 / 5	3750		-

Continued on page 28

Solid State Relays

8-Pin DIP (continued)

Part Number	Relay Type	Blocking Voltage (V _p)	Load Current (mA)	On Resistance (Ω)	Input Control Current (mA)	Switching Speeds t _{on} / t _{off} (ms)	Isolation Voltage (V _{RMS})	Off-State Leakage (μA)	Features & Comments
1-Form-A & 1-Form B Combination Relays									
LBA110	BI	350	120	35	2	3 / 3	3750	1 / 1	-
LBA110L		350	120	35	5	3 / 3			-
PBA150		250	250	7	5	2.5 / 2.5			-
LBA127		250	200	10	5	5 / 5			-
LBA120		250	170	20	5	5 / 5			-
LBA120L		250	150	25	5	5 / 5			-
LBA127L		250	150	15	5	5 / 5			-
LBA710		60	1000	0.6	2	5 / 5			High load current
LBA716		60	1000	0.4	2	5 / 5			High load current (Normally closed pole load current = 500mA)
2-Form-A Relays: Double-Pole, Single-Throw									
LCA210	BI	350	85	35	8	3 / 3	3750	1	-
LCA210L		350	85	35	8	4 / 4			Current limiting
LCA220		250	120	20	10	5 / 5			-
1-Form-C Relays: Common Input, Single-Pole, Double-Throw									
LCC110	BI	350	120	35	8	4 / 4	3750	1	-
LCC120		250	170	20	10	5 / 5			-



8-Pin Surface Mount

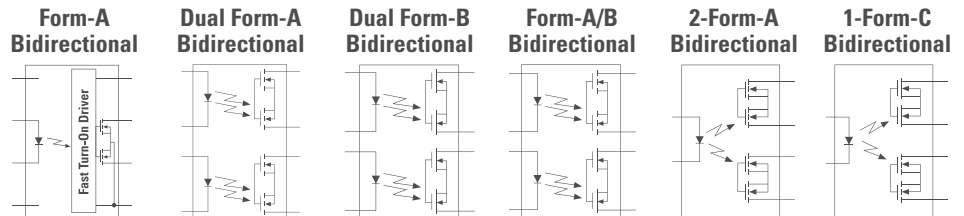

Part Number	Relay Type	Blocking Voltage (V _p)	Load Current (mA)	On Resistance (Ω)	Input Control Current (mA)	Switching Speeds t _{on} / t _{off} (ms)	Isolation Voltage (V _{RMS})	Off-State Leakage (μA)	Features & Comments
1-Form-A Relays: Single-Pole									
CPC1560S	BI+	60	300	5.6	1.1	0.1 / 0.4	3750	1	Current limiting with thermal management
1-Form-A Relays: Dual Single-Pole									
PAA193S	BI	600	100	50	5	5 / 5	5000	10	Enhanced isolation voltage
PAA191S		400	250	8	5	3 / 1	5000	1	Enhanced isolation voltage
PAA140S		400	250	8	5	3 / 1	3750	1	-
PAA140LS		400	200	13	5	5 / 3	3750	1	Current limiting
PAA110LS		400	150	25	5	1 / 0.5	3750	1	Current limiting
PAA190S		400	150	22	5	1 / 0.5	5000	1	Enhanced isolation voltage
PAA110S		400	150	22	5	1 / 0.25	3750	1	-
LAA125S		350	170	16	5	5 / 5	3750	1	-
LAA125LS		350	150	18	5	5 / 5	3750	1	Current limiting
LAA110LS		350	120	35	5	3 / 3	3750	1	Current limiting
LAA110S		350	120	35	5	3 / 3	3750	1	-
LAA100LS		350	120	25	5	5 / 5	3750	1	Current limiting
LAA100S		350	120	25	5	5 / 5	3750	1	-
XAA170S		350	100	50	5	5 / 5	3750	1	-
PAA127S		280	200	10	3	0.5 / 0.5	3750	0.025	Very low I _{LEAK} , fast switching speeds
PAA150S		250	250	7	5	2.5 / 0.5	3750	1	-
LAA127S		250	200	10	5	5 / 5	3750	1	-

Continued on page 29

Solid State Relays

8-Pin Surface Mount (continued)

1-Form-A Relays: Dual Single-Pole									
LAA120S	BI	250	170	20	5	5 / 5	3750	1	-
LAA127LS		250	170	10	5	5 / 5		1	Current limiting
LAA120LS		250	150	25	5	5 / 5		1	Current limiting
OAA160S		250	50	100	6	0.125 / 0.125		0.025	Very low I _{LEAK} , fast switching speeds
LAA108S		100	300	8	2	3 / 3		1	-
LAA710S		60	1000	0.5	10	2.5 / 0.25		1	-
PAA132S		60	600	1	2	5 / 2		1	-
XAA117S		60	150	16	1	5 / 5		1	Low I _F
1-Form-B Relays: Dual Single-Pole									
PBB190S	BI	400	130	25	2	1 / 2.5	5000	1	-
LBB110S		350	120	35	5	3 / 3	3750		-
XBB170S		350	100	50	5	5 / 5	3750		-
PBB150S		250	250	7	5	2.5 / 2.5	3750		-
LBB127S		250	200	10	5	5 / 5	3750		-
LBB120S		250	170	20	5	5 / 5	3750		-
LBB126S		250	170	15	5	5 / 5	3750		-
1-Form-A & 1-Form B Combination Relays									
LBA110LS	BI	350	120	35	5	3 / 3	3750	1 / 1	-
LBA110S		350	120	35	2	3 / 3			-
PBA150S		250	250	7	5	2.5 / 2.5			-
LBA127S		250	200	10	5	5 / 5			-
LBA120S		250	170	20	5	5 / 5			-
LBA120LS		250	150	25	5	5 / 5			-
LBA127LS		250	150	15	5	5 / 5			-
LBA716S		60	1000	0.4	2	5 / 5			High load current (Normally closed pole load current = 500mA)
LBA710S		60	1000	0.6	2	5 / 5			High load current
2-Form-A Relays: Double-Pole, Single-Throw									
LCA210S	BI	350	85	35	8	3 / 3	3750	1	-
LCA210LS		350	85	35	8	4 / 4			Current limiting
LCA220S		250	120	20	10	5 / 5			-
1-Form-C Relays: Common Input, Single-Pole, Double-Throw									
LCC110S	BI	350	120	35	8	4 / 4	3750	1	-
LCC120S		250	170	20	10	5 / 5			-



8-Pin SOP

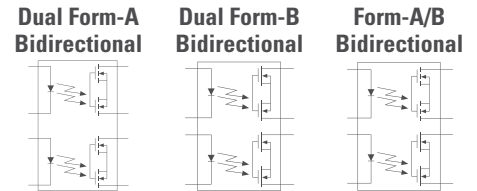

Part Number	Relay Type	Blocking Voltage (V _F)	Load Current (mA)	On Resistance (Ω)	Input Control Current (mA)	Switching Speeds t _{on} / t _{off} (ms)	Isolation Voltage (V _{RMS})	Off-State Leakage (μA)	Features & Comments
1-Form-A Relays: Dual Single-Pole									
CPC2025N	BI	400	120	30	2	2 / 1	1500	1	-
CPC2030N		350	120	30	2	2 / 1			-
CPC2014N		60	400	2	2	2 / 1			EN 50130-4
CPC2017N		60	120	16	1	3 / 3			Low I _F , EN 50130-4
1-Form-B Relays: Dual Single-Pole									
CPC2125N	BI	400	100	35	2	2 / 2	1500	5	-
1-Form-A & 1-Form B Combination Relays									
CPC2330N	BI	350	120	30	2	3 / 3	1500	1 / 5	-
CPC2317N		60	120	16	1	3 / 3		1 / 1	Low I _F

Solid State Relays



Power SIP

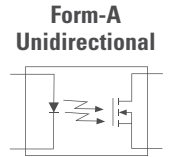
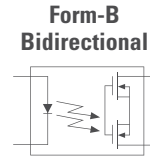
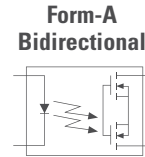

Part Number	Relay Type	Blocking Voltage (V _p)	Load Current (mA)	On Resistance (Ω)	Input Control Current (mA)	Switching Speeds t _{on} / t _{off} (ms)	Isolation Voltage (V _{RMS})	Off-State Leakage (μA)	Features & Comments
1-Form-A Relays: Single-Pole									
CPC1981Y	BI	1000	180	18	10	10 / 5	2500	1	-
CPC1984Y	BI	600	1000	0.66	5	10 / 2	4000		-
CPC1983YE	BI	600	500	6	5	5 / 2	4000		-
CPC1983Y	BI	600	500	6	5	5 / 2	2500		-
CPC1973Y	BI	400	350	5	10	5 / 3	2500		-
CPC1726Y	UNI	250	1000	0.75	10	5 / 2	2500		-
CPC1926Y	BI	250	700	1.4	10	10 / 10	2500		-
CPC1511Y	BI	230	450	4	2.5	4 / 2	3750		Current limiting with thermal management
CPC1916Y	BI	100	2500	0.34	10	5 / 3	2500		-
CPC1706Y	UNI	60	4000	0.09	5	5 / 2	2500		-
CPC1906Y	BI	60	2000	0.3	10	10 / 5	2500	-	
1-Form-B Relays: Single-Pole									
CPC1705Y	UNI	60	3250	0.09	5	2 / 12	2500	1	-



Power SOIC

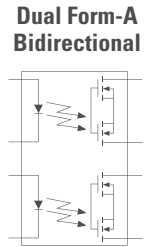
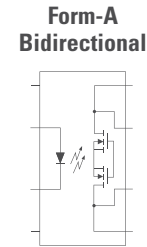

Part Number	Relay Type	Blocking Voltage (V _p)	Load Current (mA)	On Resistance (Ω)	Input Control Current (mA)	Switching Speeds t _{on} / t _{off} (ms)	Isolation Voltage (V _{RMS})	Off-State Leakage (μA)	Features & Comments
1-Form-A Relays: Single-Pole									
CPC1983B	BI	600	500	6	5	5 / 2	5000	1	-
CPC1907B		60	6000	0.06		5 / 1			
1-Form-A Relays: Dual Single-Pole									
CPC2907B	BI	60	2000	0.15	5	2.5 / 0.25	4000	1	DUAL: two independent relays in one package



16-Pin SOIC

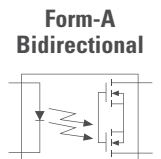

Part Number	Relay Type	Blocking Voltage (V _p)	Load Current (mA)	On Resistance (Ω)	Input Control Current (mA)	Switching Speeds t _{on} / t _{off} (ms)	Isolation Voltage (V _{RMS})	Off-State Leakage (μA)	Features & Comments
1-Form-A Relays: Single-Pole									
CPC1561B	BI	60	1000	0.245	2.5	2.5 / 0.5	3750	1	Current limiting with thermal management

Fault Protected Solid State Relays



6-Pin Surface Mount

Form-A Bidirectional

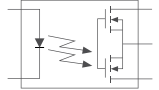

Part Number	Blocking Voltage (V _p)	Input Control Current (mA)	On-Resistance (Maximum)		Load Current (Maximum)		Current Limit (Maximum)		* VTS Threshold V _{TH} (V)	Switching Speed t _{on} / t _{off} (ms)	Isolation Voltage (V _{RMS})	Features & Comments
			DC-Only (Ω)	AC (Ω)	DC-Only (mA)	AC (mA)	DC-Only (mA _p)	AC (mA _p)				
Active Current Limiting SSRs with Voltage Triggered Shutdown & Thermal Management												
CPC1593GS	600	2	11.75	35	250	120	570	285	21	2 / 2	3750	Power supply start-up
CPC1563GS	600		11.75	35	250	120	570	285	100			High blocking voltage
CPC1540GS	350		6.75	25	250	120	570	285	100			PSTN hook switch applications
CPC1510GS	250		3.75	15	350	200	920	450	-			Industrial applications

* Load current is reduced to approximately 100µA or less whenever the voltage across the switches exceeds the threshold V_{TH} while the relay is in current limit



6-Pin DIP

Form-A Bidirectional

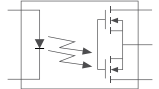

Part Number	Blocking Voltage (V _p)	Input Control Current (mA)	On-Resistance (Maximum)		Load Current (Maximum)		Current Limit (Maximum)		* VTS Threshold V _{TH} (V)	Switching Speed t _{on} / t _{off} (ms)	Isolation Voltage (V _{RMS})	Features & Comments
			DC-Only (Ω)	AC (Ω)	DC-Only (mA)	AC (mA)	DC-Only (mA _p)	AC (mA _p)				
Active Current Limiting SSRs with Voltage Triggered Shutdown & Thermal Management												
CPC1563G	600	2	11.75	35	250	120	570	285	100	2 / 2	3750	High blocking voltage
CPC1593G	600		11.75	35	250	120	570	285	21			Power supply start-up
CPC1540G	350		6.75	25	250	120	570	285	100			PSTN hook switch applications
CPC1510G	250		3.75	15	350	200	920	450	-			Industrial applications

* Load current is reduced to approximately 100µA or less whenever the voltage across the switches exceeds the threshold V_{TH} while the relay is in current limit



8-Pin DIP

Form-A Bidirectional

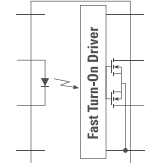

Part Number	Blocking Voltage (V _p)	Input Control Current (mA)	On-Resistance (Maximum)		Load Current (Maximum)		Current Limit (Maximum)		Switching Speed t _{on} / t _{off} (ms)	Isolation Voltage (V _{RMS})	Features & Comments
			DC-Only (Ω)	AC (Ω)	DC-Only (mA)	AC (mA)	DC-Only (mA _p)	AC (mA _p)			
Active Current Limiting SSRs with Voltage Triggered Shutdown & Thermal Management											
CPC1560G	60	1.1	1.4	5.6	600	300	1500	900	0.1 / 0.4	3750	Fast switching speeds

Fault Protected Solid State Relays



8-Pin Surface Mount

Form-A Bidirectional

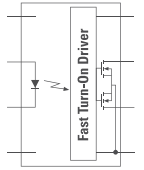

Part Number	Blocking Voltage (V _p)	Input Control Current (mA)	On-Resistance (Maximum)		Load Current (Maximum)		Current Limit (Maximum)		Switching Speed t _{on} / t _{off} (ms)	Isolation Voltage (V _{RMS})	Features & Comments
			DC-Only (Ω)	AC (Ω)	DC-Only (mA)	AC (mA)	DC-Only (mA _p)	AC (mA _p)			
Active Current Limiting SSRs with Voltage Triggered Shutdown & Thermal Management											
CPC1560GS	60	1.1	1.4	5.6	600	300	1500	900	0.1 / 0.4	3750	Fast switching speeds



16-Pin SOIC

Form-A Bidirectional

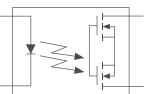

Part Number	Blocking Voltage (V _p)	Input Control Current (mA)	On-Resistance (Maximum)		Load Current (Maximum)		Current Limit (Maximum)		Switching Speed t _{on} / t _{off} (ms)	Isolation Voltage (V _{RMS})	Features & Comments
			DC-Only (Ω)	AC (Ω)	DC-Only (mA)	AC (mA)	DC-Only (mA _p)	AC (mA _p)			
Active Current Limiting SSRs with Voltage Triggered Shutdown & Thermal Management											
CPC1561B	60	2.5	-	0.245	-	1000	-	3000	2.5 / 0.5	3750	1A Load current rating to 60°C



Power SIP

Form-A Bidirectional

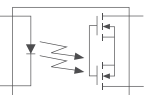

Part Number	Blocking Voltage (V _p)	Input Control Current (mA)	On-Resistance (Maximum)		Load Current (Maximum)		Current Limit (Maximum)		Switching Speed t _{on} / t _{off} (ms)	Isolation Voltage (V _{RMS})	Features & Comments
			DC-Only (Ω)	AC (Ω)	DC-Only (mA)	AC (mA)	DC-Only (mA _p)	AC (mA _p)			
Active Current Limiting SSRs with Voltage Triggered Shutdown & Thermal Management											
CPC1511Y	230	2.5	-	4	-	450	-	1400	4 / 2	3750	Industrial applications

Optically Isolated Power Relays



i4-PAC

1-Form-A Bidirectional

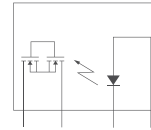

1-Form-A Unidirectional

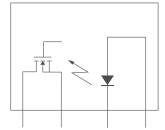

Part Number	Relay Type	Blocking Voltage (V _p)	Load Current (A _{RMS})			On Resistance (Ω)	Input Control Current (mA)	Switching Speeds t _{on} / t _{off} (ms)	Isolation Voltage (V _{RMS})	Off-State Leakage (μA)
			Without Heat Sink	5°C/W Heat Sink	T _c =25°C					
1-Form-A Power Relays: Single-Pole - Bidirectional										
CPC1986J	BI	1000	0.65	1.6	6.5	3	10	20 / 5	2500	1
CPC1978J		800	0.75	1.85	7.25	2.3				
CPC1977J		600	1.25	3.1	12.25	1				
CPC1967J		400	1.35	3.35	13.15	0.85				
CPC1908J		60	3.5	8.5	15	0.3				
Part Number	Relay Type	Blocking Voltage (V _p)	Load Current (A)			On Resistance (Ω)	Input Control Current (mA)	Switching Speeds t _{on} / t _{off} (ms)	Isolation Voltage (V _{RMS})	Off-State Leakage (μA)
1-Form-A Power Relays: Single-Pole - Unidirectional										
CPC1786J	UNI	1000	0.65	1.75	6.9	2	10	20 / 5	2500	1
CPC1777J		600	1.5	4.6	15	0.5				
CPC1708J		60	4	11.85	24	0.08				



ISOPLUS-264

1-Form-A Bidirectional

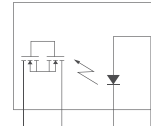

1-Form-A Unidirectional

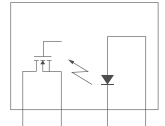

Part Number	Relay Type	Blocking Voltage (V _p)	Load Current (A _{RMS})			On Resistance (Ω)	Input Control Current (mA)	Switching Speeds t _{on} / t _{off} (ms)	Isolation Voltage (V _{RMS})	Off-State Leakage (μA)
			Without Heat Sink	5°C/W Heat Sink	T _c =25°C					
1-Form-A Power Relays: Single-Pole - Bidirectional										
CPC1988J	BI	1000	0.9	2.25	9.4	2.5	10	25 / 10	2500	1
CPC1979J		600	1.4	3.5	14.5	0.75				
CPC1968J		500	2	5	15	0.35				
CPC1927J		250	2.7	6.7	15	0.2				
CPC1918J		100	5.25	13	15	0.1				
CPC1909J		60	6.5	15	15	0.1				
Part Number	Relay Type	Blocking Voltage (V _p)	Load Current (A)			On Resistance (Ω)	Input Control Current (mA)	Switching Speeds t _{on} / t _{off} (ms)	Isolation Voltage (V _{RMS})	Off-State Leakage (μA)
1-Form-A Power Relays: Single-Pole - Unidirectional										
CPC1788J	UNI	1000	1	2.45	10.3	1.25	10	20 / 5	2500	1
CPC1779J		600	1.65	4.12	15	0.4				
CPC1727J		250	3.4	8.6	20	0.09				
CPC1718J		100	6.75	17.5	32	0.075				
CPC1709J		60	9	22.8	32	0.05				

Optically Isolated AC Power Switches



4-Pin DIP (16-pin Body)

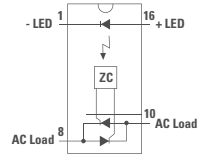

Part Number	Blocking Voltage (V _p)	Load Current (A _{RMS})	Input Control Current (mA)	Turn-On: Zero-Cross or Rapid	Operating Frequency Range (Hz)	Isolation Voltage (V _{RMS})
Optically Isolated AC Power Switches						
PD2601	600	1	5	Zero-cross	20 - 500	3750
CPC1965G	600				20 - 400	
PD2401	500				20 - 500	
CPC1945G	400				20 - 400	
PD1201	400				20 - 500	



6-Pin Surface Mount

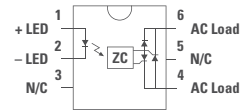

Part Number	Blocking Voltage (V _p)	Load Current (A _{RMS})	Input Control Current (mA)	Turn-On: Zero-Cross or Rapid	Operating Frequency Range (Hz)	Isolation Voltage (V _{RMS})
Optically Isolated AC Power Switches						
CPC1972GS	800	0.25	5	Zero-cross	20 - 500	3750



6-Pin DIP

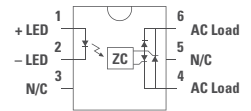

Part Number	Blocking Voltage (V _p)	Load Current (A _{RMS})	Input Control Current (mA)	Turn-On: Zero-Cross or Rapid	Operating Frequency Range (Hz)	Isolation Voltage (V _{RMS})
Optically Isolated AC Power Switches						
CPC1972G	800	0.25	5	Zero-cross	20 - 500	3750



6-Pin Power DIP

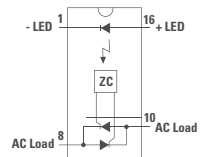

Part Number	Blocking Voltage (V _p)	Load Current (A _{RMS})	Input Control Current (mA)	Turn-On: Zero-Cross or Rapid	Operating Frequency Range (Hz)	Isolation Voltage (V _{RMS})
Optically Isolated AC Power Switches						
PM1206	600	0.5	5	Zero-cross	20 - 500	3750
CPC1963G	600					
PM1205	500					
CPC1943G	400					
PM1204	400					

Optically Isolated AC Power Switches



6-Pin Power DIP Surface Mount

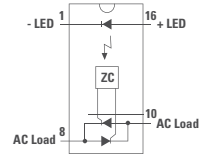

Part Number	Blocking Voltage (V _p)	Load Current (A _{RMS})	Input Control Current (mA)	Turn-On: Zero-Cross or Rapid	Operating Frequency Range (Hz)	Isolation Voltage (V _{RMS})
Optically Isolated AC Power Switches						
CPC1963GS	600	0.5	5	Zero-Cross	20 - 500	3750
PM1206S	600					
PM1205S	500					
CPC1943GS	400					
PM1204S	400					



8-Pin DIP

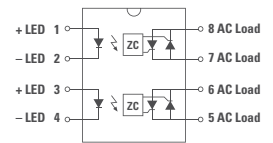

Part Number	Blocking Voltage (V _p)	Load Current (A _{RMS})	Input Control Current (mA)	Turn-On: Zero-Cross or Rapid	Operating Frequency Range (Hz)	Isolation Voltage (V _{RMS})	Features & Comments
Optically Isolated AC Power Switches							
CPC1961G	600	0.25 ¹	5	Zero-Cross	20 - 500	3750	Dual AC power switch

¹ Maximum continuous load current of a single pole or the sum of the load currents with both poles operating simultaneously



8-Pin Surface Mount

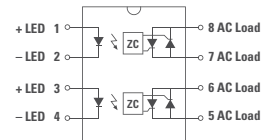

Part Number	Blocking Voltage (V _p)	Load Current (A _{RMS})	Input Control Current (mA)	Turn-On: Zero-Cross or Rapid	Operating Frequency Range (Hz)	Isolation Voltage (V _{RMS})	Features & Comments
Optically Isolated AC Power Switches							
CPC1961GS	600	0.25 ¹	5	Zero-Cross	20 - 500	3750	Dual AC power switch

¹ Maximum continuous load current of a single pole or the sum of the load currents with both poles operating simultaneously

How is the Optically Isolated AC Power Switch Used Here?

Gas Pump

Gas and fuel pump motors need to be switched by galvanically isolated semiconductor switches to avoid the potential risk of ignition of these flammable substances by contact arcing if compared to any mechanical relays or switches. Solid state relays do not feature any mechanical contacts or other mechanical components, thus there is no contact arcing.



Optically Isolated AC Power Switches



4-Pin SIP (8-Pin Body)

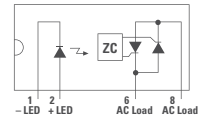

Part Number	Blocking Voltage (V _p)	Load Current (A _{RMS})	Input Control Current (mA)	Operating Frequency Range (Hz)	Turn On: Zero-Cross or Rapid	Isolation Voltage (V _{RMS})	Features & Comments
Optically Isolated AC Power Switches							
PS2601	600	1	5	20 - 500	Zero-cross	3750	-
CPC1965Y	600			20 - 400			-
PS2401	500			20 - 500			-
CPC1945Y	400			20 - 400			-
PS1201	400			20 - 500			-



i4-PAC

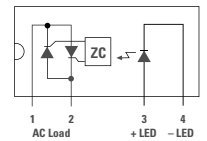

Part Number	Blocking Voltage (V _p)	Load Current			Input Control Current (mA)	Operating Frequency Range (Hz)	Turn-On: Zero-Cross or Rapid	Switching Speed t _{on} / t _{off} (max)	Isolation Voltage (V _{RMS})	Features & Comments
		Without Heat Sink (A _{RMS})	5°C/W Heat Sink (A _{RMS})	T _c =25°C (A _{RMS})						
Optically Isolated AC Power Switches										
CPC1998J	800	5	20	50	5	20 - 500	Zero-cross	½ Cycle	2500	High load current



Power SIP

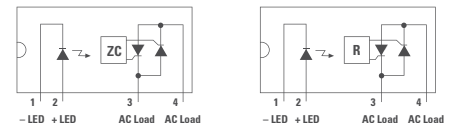

Part Number	Blocking Voltage (V _p)	Load Current (A _{RMS})	Input Control Current (mA)	Operating Frequency Range (Hz)	Turn-On: Zero-Cross or Rapid	Switching Speed t _{on} / t _{off} (max)	Isolation Voltage (V _{RMS})
Optically Isolated AC Power Switches							
CPC1966YX8	800	3	5	20 - 500	Rapid	45µs ¹ / ½ Cycle	3750
CPC1966Y	600	3			Zero-cross	½ Cycle	
CPC1976Y	600	2			Zero-cross	½ Cycle	
CPC1976YX6	600	2			Rapid	500µs / ½ Cycle	
CPC1966YX6	600	3			Rapid	500µs / ½ Cycle	

Notes
1. Typical turn-on values

Optically Isolated AC Power Switches



SuperSIP

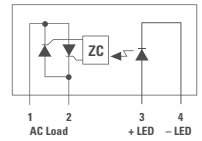

Part Number	Blocking Voltage (V _p)	Load Current			Input Control Current (mA)	Operating Frequency Range (Hz)	Turn-On: Zero-Cross or Rapid	Switching Speed t _{on} / t _{off} (max)	Isolation Voltage (V _{RMS})	Features & Comments
		Without Heat Sink (A _{RMS})	5°C/W Heat Sink (A _{RMS})	T _c =25°C (A _{RMS})						
Optically Isolated AC Power Switches										
CPC40055ST	800	5	20	40	5	20 - 500	Zero-cross	½ Cycle	2500	High load current, 8.788mm creepage



Power SOIC

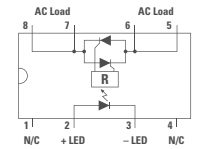
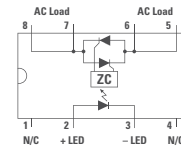

Part Number	Blocking Voltage (V _p)	Load Current (A _{RMS})	Input Control Current (mA)	Operating Frequency Range (Hz)	Turn-On: Zero-Cross or Rapid	Switching Speed t _{on} / t _{off} (max)	Isolation Voltage (V _{RMS})	Features & Comments
CPC1966B	800	3	5	20 - 500	Zero-cross	½ Cycle	5000	Enhanced isolation voltage, 12.5mm creepage
CPC1966BX8	800	3			Rapid	45µs / ½ Cycle		
CPC1964B	800	1.5			Zero-cross	½ Cycle		
CPC1964BX6	600	1.5			Rapid	500µs / ½ Cycle		

Notes
1. Typical turn-on values

How is the OptoMOS® AC Power Switch Used Here?

Smart Home

OptoMOS® AC Power Switches are ideal for switching smaller loads in all kind of applications including home automation or smart home. The input and output circuits are optically coupled to provide up to 5000V_{RMS} of galvanic isolation and noise immunity between control and load circuits. The product line includes devices with blocking voltages of up to 800V_{AC} peak.

Long life and environmental integrity make these power switches ideal for controlling a variety of AC load circuits.

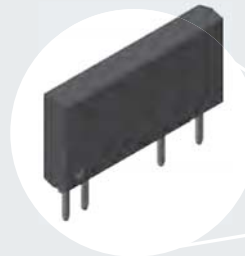

IGBT & MOSFET Low-Side Gate Drivers

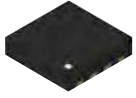

8-Pin (3 x 3)mm DFN

Logic Configurations

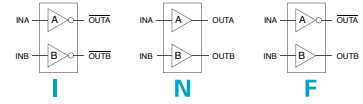

Part Number	Output Type	I_{PEAK} $T_C=25^\circ\text{C}$ (A _p)	Output Resistance (Ω)	Available Logic Configurations	Enable Function	Under-voltage Lockout (V)
Low-Side Gate Drivers						
IX4426M	DUAL	1.5	8	I	-	-
IX4427M				N	-	-
IX4428M				F	-	-

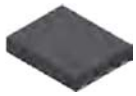

8-Pin (5 x 4)mm DFN

Logic Configurations

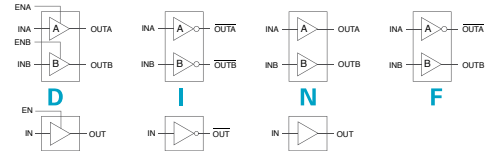

Part Number	Output Type	I_{PEAK} $T_C=25^\circ\text{C}$ (A _p)	Output Resistance (Ω)	Available Logic Configurations	Enable Function	Under-voltage Lockout (V)
Low-Side Gate Drivers						
IXD_602D2	DUAL	2	4	I, N, F	-	-
IXD_604D2	DUAL	4	2.5	D, I, N, F	•	-
IXD_609D2	SINGLE	9	1	D, I, N	•	-



8-Pin SOIC

Logic Configurations

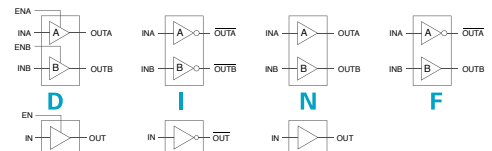

Part Number	Output Type	I_{PEAK} $T_C=25^\circ\text{C}$ (A _p)	Output Resistance (Ω)	Available Logic Configurations	Enable Function	Under-voltage Lockout (V)
Low-Side Gate Drivers						
IX4426N	DUAL	1.5	8	I	-	-
IX4427N	DUAL	1.5	8	N	-	-
IX4428N	DUAL	1.5	8	F	-	-
IXD_602SIA	DUAL	2	4	I, N, F	-	-
IXD_604SIA	DUAL	4	2.5	D, I, N, F	•	-
IX4340N	DUAL	5	1.5	D	•	3.8
IXD_609SIA	SINGLE	9	1	D, I, N	•	-
AEC-Q100 Qualified Low-Side Gate Drivers						
IXD_604SIA	DUAL	4	2.5	D, I, N, F	•	-

IGBT & MOSFET Low-Side Gate Drivers



8-Pin SOIC (With Exposed Heat Sink Pad)

Logic Configurations

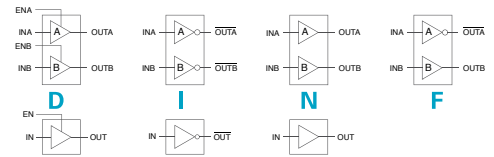

Part Number	Output Type	I_{PEAK} $T_c=25^\circ\text{C}$ (A_p)	Output Resistance (Ω)	Available Logic Configurations	Enable Function	Under-voltage Lockout (V)
Low-Side Gate Drivers						
IXD_602SI	DUAL	2	4	I, N, F	-	-
IXD_604SI	DUAL	4	2.5	D, I, N, F	•	-
IX4340NE	DUAL	5	1.5	D	•	3.8
IXD_609SI	SINGLE	9	1	D, I, N	•	-
IXD_614SI	SINGLE	14	0.8	D, I, N	•	-
AEC-Q100 Qualified Low-Side Gate Drivers						
IX4340NE	DUAL	5	1.5	D	•	3.8
IXD_604SI	DUAL	4	2.5	D, I, N, F		-
IXD_609SI	SINGLE	9	1	D, I, N		-
IXD_614SI	SINGLE	14	0.8	D, I, N		-



8-Pin DIP

Logic Configurations

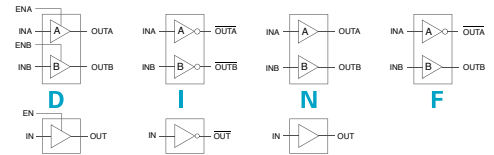

Part Number	Output Type	I_{PEAK} $T_c=25^\circ\text{C}$ (A_p)	Output Resistance (Ω)	Available Logic Configurations	Enable Function	Under-voltage Lockout (V)
Low-Side Gate Drivers						
IXD_602PI	DUAL	2	4	I, N, F	-	-
IXD_604PI	DUAL	4	2.5	D, I, N, F	•	-
IXD_609PI	SINGLE	9	1	I, N, F	•	-
IXD_614PI	SINGLE	14	0.8	I, N, F	•	-



8-Pin MSOP (With Exposed Heat Sink Pad)

Logic Configuration

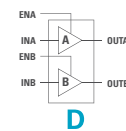

Part Number	Output Type	I_{PEAK} $T_c=25^\circ\text{C}$ (A_p)	Output Resistance (Ω)	Available Logic Configurations	Enable Function	Under-voltage Lockout (V)
Low-Side Gate Drivers						
IX4340UE	DUAL	5	1.5	D	•	3.8

IGBT & MOSFET Low-Side Gate Drivers



5-Pin SOT23

Logic Configuration

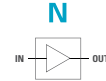

Part Number	Output Type	I_{PEAK} $T_c=25^\circ\text{C}$ (A_p)	Output Resistance (Ω)	Available Logic Configurations	Enable Function	Under-voltage Lockout (V)
Low-Side Gate Drivers						
IX4310T	SINGLE	2	3	N	-	4.2



5-Pin TO-220

Logic Configurations

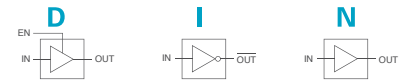

Part Number	Output Type	I_{PEAK} $T_c=25^\circ\text{C}$ (A_p)	Output Resistance (Ω)	Available Logic Configurations	Enable Function	Under-voltage Lockout (V)
Low-Side Gate Drivers						
IXD_609CI	SINGLE	9	1	D, I, N	•	-
IXD_614CI	SINGLE	14	0.8	D, I, N	•	-
IXD_630CI	SINGLE	30	0.4	D, I, N	•	12.5
IXD_630MCI	SINGLE	30	0.4	D, I, N	•	9



5-Pin TO-263

Logic Configurations

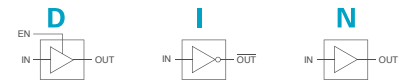

Part Number	Output Type	I_{PEAK} $T_c=25^\circ\text{C}$ (A_p)	Output Resistance (Ω)	Available Logic Configurations	Enable Function	Under-voltage Lockout (V)
Low-Side Gate Drivers						
IXD_609YI	SINGLE	9	1	D, I, N	•	-
IXD_614YI	SINGLE	14	0.8	D, I, N	•	-
IXD_630YI	SINGLE	30	0.4	D, I, N	•	12.5
IXD_630MYI	SINGLE	30	0.4	D, I, N	•	9

How is the Gate Driver Used Here?

Off-board EV Charger

High speed Gate Driver ICs are efficiently driving Power-MOSFET or IGBT devices. The gate drivers convert the controller's PWM signals into gate-signals compatible to Si-/SiC-MOSFETs or IGBTs, providing an optimal power semiconductor control while minimizing power losses. Built-in protection features protect both, the gate driver as well as the power semiconductors.

Typical applications are all kind of chargers and power inverters including on-board and off-board chargers for electrical vehicles as shown in the illustration as one example out of many.



SiC MOSFET & IGBT Low-Side Gate Drivers



16-Pin Narrow SOIC (With Exposed Heat Sink Pad)

Part Number	Drive Current (A_{PEAK})	Output Resistance Source/Sink (Ω)	Logic Configurations	Enable Function	Under Voltage Lockout Maximum Threshold (V)	Internal Charge Pump Generates Selectable Negative Drive Voltage	Internal Logic Level Shifter	Separate Sink and Source Output Pins	Desaturation Detection with Soft Shutdown	Thermal Shutdown	Open-Drain Fault Output
Low-Side Driver With Charge Pump											
IX4351NE	9	2	Non-Inverting	No	10	•	•	•	•	•	•
AEC-Q100 Qualified Low-Side Driver											
IX4351NEAU	9	2	Non-Inverting	No	10	•	•	•	•	•	•

IX4351 Evaluation Board

IXYS Integrated Circuits Division's IX4351 Evaluation Board contains all the necessary circuitry to demonstrate the features of a high power SiC MOSFET gate driver and SiC MOSFET. The board includes an LSIC1MO120E0080 1200V SiC MOSFET from Littelfuse with an $R_{DS(ON)}$ of 80m Ω typical and an I_D of 25A. The board has an optically isolated interface for the input drive and FAULT output indication pin.

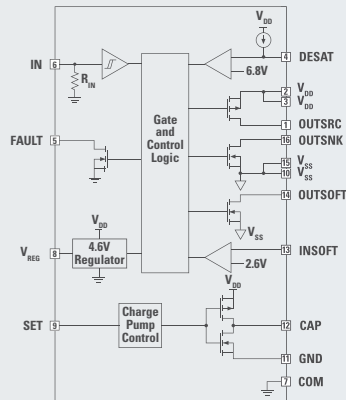

IGBT & MOSFET High-Speed Gate Drivers

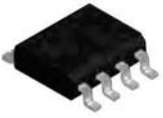

8-Pin SOIC

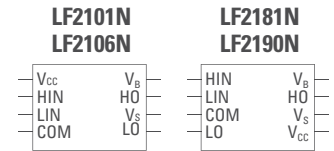

Part Number	Max. Offset Voltage	Typ. Sink / Source Peak Drive Current	Inputs	Deadtime	Propagation Delay t_{on} / t_{off}	Rise / Fall Time t_r / t_f
High-Side and Low-Side Gate Drivers						
LF2101NTR	600V	600mA / 290mA	HIN / LIN	None	160ns / 150ns	70ns / 35ns
LF2106NTR		290mA / 600mA			220ns / 200ns	100ns / 35ns
LF2181NTR		2.3A / 1.9A			180ns / 220ns	40ns / 20ns
LF2190NTR		4.5A / 4.5A			140ns / 140ns	25ns / 20ns



14-Pin SOIC

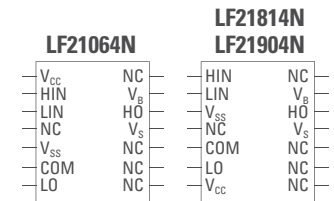

Part Number	Max. Offset Voltage	Typ. Sink / Source Peak Drive Current	Inputs	Deadtime	Propagation Delay t_{on} / t_{off}	Rise / Fall Time t_r / t_f
High-Side and Low-Side Gate Drivers						
LF21064NTR	600V	600mA / 290mA	HIN / LIN	None	220ns / 200ns	100ns / 35ns
LF21814NTR		2.3A / 1.9A			180ns / 220ns	40ns / 20ns
LF21904NTR		4.5A / 4.5A			140ns / 140ns	25ns / 20ns



16-Pin SOIC

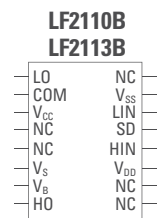

Part Number	Max. Offset Voltage	Typ. Sink / Source Peak Drive Current	Inputs	Deadtime	Propagation Delay t_{on} / t_{off}	Rise / Fall Time t_r / t_f
High-Side and Low-Side Gate Drivers						
LF2110BTR	500V	2.5A / 2.5A	HIN / LIN	None	105ns / 94ns	15ns / 13ns
LF2113BTR	600V					

IGBT & MOSFET High-Speed Gate Drivers

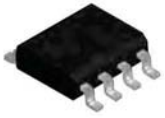

8-Pin SOIC

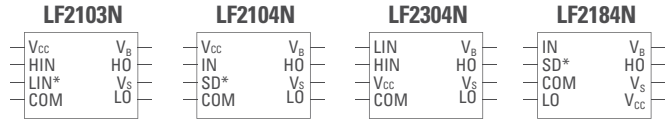

Part Number	Max. Offset Voltage	Typ. Sink / Source Peak Drive Current	Inputs	Deadtime	Propagation Delay t_{on} / t_{off}	Rise / Fall Time t_r / t_f
Half-Bridge Gate Drivers						
LF2103NTR	600V	600mA / 290mA	HIN / LIN*	520ns	680ns / 150ns	70ns / 35ns
LF2104NTR		600mA / 290mA	IN / SD*	520ns	680ns / 150ns	70ns / 35ns
LF2304NTR		600mA / 290mA	HIN / LIN	100ns	150ns / 150ns	70ns / 35ns
LF2184NTR		2.3A / 1.9A	IN / SD*	400ns	680ns / 270ns	40ns / 20ns



14-Pin SOIC

LF21844N

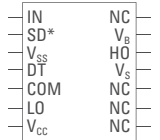

Part Number	Max. Offset Voltage	Typ. Sink / Source Peak Drive Current	Inputs	Deadtime	Propagation Delay t_{on} / t_{off}	Rise / Fall Time t_r / t_f
Half-Bridge Gate Drivers						
LF21844NTR	600V	2.3A / 1.9A	IN / SD*	400ns - 5ms	680ns / 270ns	40ns / 20ns



20-Pin SOIC

LF2388B

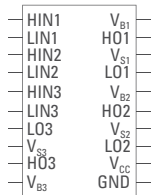

Part Number	Max. Offset Voltage	Typ. Sink / Source Peak Drive Current	Inputs	Deadtime	Propagation Delay t_{on} / t_{off}	Rise / Fall Time t_r / t_f
3-Phase Half-Bridge Gate Driver						
LF2388BTR	600V	650mA / 350mA	HIN / LIN	270ns	130ns / 150ns	50ns / 35ns



28-Pin SOIC

LF2136B

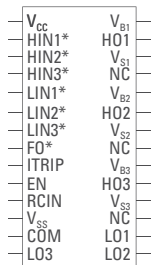

Part Number	Max. Offset Voltage	Typ. Sink / Source Peak Drive Current	Inputs	Deadtime	Propagation Delay t_{on} / t_{off}	Rise / Fall Time t_r / t_f
3-Phase Half-Bridge Gate Driver						
LF2136BTR	600V	350mA / 200mA	HIN* / LIN*	290ns	330ns / 330ns	90ns / 35ns

Optically Isolated Gate Drivers



8-Pin DIP Dual Channel Photovoltaic Gate Driver

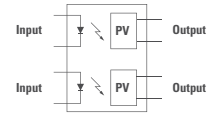

Part Number	Input Control Current (mA)	Open-Circuit Voltage V_{oc} (V)	Minimum Short-Circuit Current (μ A)	Nominal Short-Circuit Current (μ A)	Switching Speeds t_{on} / t_{off} (ms)	Isolation Voltage (V_{RMS})
Optically Isolated Photovoltaic Gate Drivers						
FDA215	5	5.5	1	2.5	5 / 5	3750
FDA217		11.75	2.5	4.5	2 / 0.5	



8-Pin Surface Mount Dual Channel Photovoltaic Gate Driver

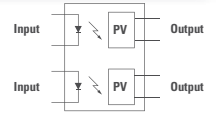

Part Number	Input Control Current (mA)	Open-Circuit Voltage V_{oc} (V)	Minimum Short-Circuit Current (μ A)	Nominal Short-Circuit Current (μ A)	Switching Speeds t_{on} / t_{off} (ms)	Isolation Voltage (V_{RMS})
Optically Isolated Photovoltaic Gate Drivers						
FDA215S	5	5.5	1	2.5	5 / 5	3750
FDA217S		11.75	2.5	4.5	2 / 0.5	



8-Pin DIP Load-Biased Gate Driver

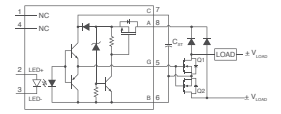

Part Number	Input Control Current (mA)	Open-Circuit Voltage V_{oc} (V)	Blocking Voltage (V)	Minimum Short-Circuit Current (μ A)	Maximum Short-Circuit Current (μ A)	Switching Speeds t_{on} / t_{off} (ms)	Isolation Voltage (V_{RMS})
Optically Isolated Load-Biased Gate Drivers							
CPC1596G	2.5	14.4	570	2	13	0.08 / 0.6	3750



8-Pin Surface Mount Load-Biased Gate Driver

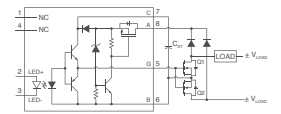

Part Number	Input Control Current (mA)	Open-Circuit Voltage V_{oc} (V)	Blocking Voltage (V)	Minimum Short-Circuit Current (μ A)	Maximum Short-Circuit Current (μ A)	Switching Speeds t_{on} / t_{off} (ms)	Isolation Voltage (V_{RMS})
Optically Isolated Load-Biased Gate Drivers							
CPC1596GS	2.5	14.4	570	2	13	0.08 / 0.6	3750



8-Pin Flatpack Load-Biased Gate Driver

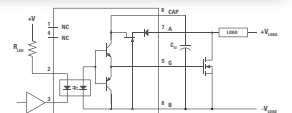

Part Number	Input Control Current (mA)	Gate Voltage @ $I_T=5mA$ (V_G)	Blocking Voltage (V_P)	Regulated Capacitor Voltage ($V_{CAP-MAX}$)	Switching Speeds t_{on} / t_{off} (μ s)	Isolation Voltage (V_{RMS})
Optically Isolated Load-Based Gate Drivers						
CPC1580P	2.5	7.5 - 12	65	$V_{DS} - 0.2V$	40 / 400	3750
CPC1590P			200	16		

Linear/Standard Optocouplers



8-Pin DIP Linear Optocoupler

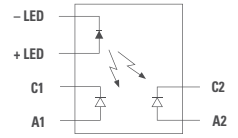

Part Number	Servo Gain $K1=I_2/I_F$ (Min - Max)	Forward Gain $K2=I_2/I_F$ (Min - Max)	Transfer Gain $K3=K_2/K_1$ (Min - Max)	Input Control Current (mA)	Isolation Voltage (V_{RMS})
Linear Optocouplers					
LOC110	0.004 - 0.03	0.004 - 0.03	0.668 - 1.179	2 - 10	3750
LOC111	0.008 - 0.03	0.006 - 0.03	0.733 - 1.072		
LOC112	0.004 - 0.03	0.004 - 0.03	0.733 - 1.072		
LOC117	0.008 - 0.03	0.006 - 0.03	0.887 - 1.072		



8-Pin Surface Mount Linear Optocoupler

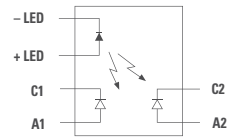

Part Number	Servo Gain $K1=I_2/I_F$ (Min - Max)	Forward Gain $K2=I_2/I_F$ (Min - Max)	Transfer Gain $K3=K_2/K_1$ (Min - Max)	Input Control Current (mA)	Isolation Voltage (V_{RMS})
Linear Optocouplers					
LOC110S	0.004 - 0.03	0.004 - 0.03	0.668 - 1.179	2 - 10	3750
LOC111S	0.008 - 0.03	0.006 - 0.03	0.733 - 1.072		
LOC112S	0.004 - 0.03	0.004 - 0.03	0.733 - 1.072		
LOC117S	0.008 - 0.03	0.006 - 0.03	0.887 - 1.072		



8-Pin Flatpack Linear Optocoupler

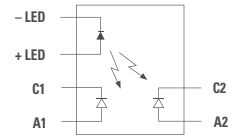

Part Number	Servo Gain $K1=I_2/I_F$ (Min - Max)	Forward Gain $K2=I_2/I_F$ (Min - Max)	Transfer Gain $K3=K_2/K_1$ (Min - Max)	Input Control Current (mA)	Isolation Voltage (V_{RMS})
Linear Optocouplers					
LOC110P	0.004 - 0.03	0.004 - 0.03	0.668 - 1.179	2 - 10	3750
LOC111P	0.008 - 0.03	0.006 - 0.03	0.733 - 1.072		
LOC112P	0.004 - 0.03	0.004 - 0.03	0.733 - 1.072		
LOC117P	0.008 - 0.03	0.006 - 0.03	0.887 - 1.072		



4-Pin SOP Optocoupler

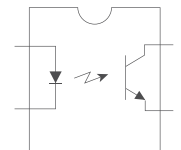

Part Number	Minimum Breakdown Voltage (BV_{CEO})	Typical Current Transfer Ratio (%)	Maximum Saturation Voltage (V)	Input Control Current (mA)	Minimum Isolation Voltage (V_{RMS})
Single Optocouplers					
CPC1001N	30	330	0.3	0.2	1500

Depletion Mode MOSFET



SOT-89

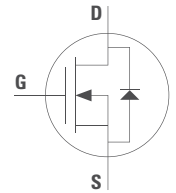

Part Number	$V_{(BR)DSX}$ (V)	I_D Min (mA)	$R_{DS(on)}$ Max (Ω)	$V_{GS(off)}$ Min (V)	$V_{GS(off)}$ Max (V)
N-Channel Depletion Mode MOSFETs					
CPC3701C	60	600	1	-1.4	-3.1
CPC3703C	250	360	4	-1.6	-3.9
CPC3708C	350	130	14	-2	-3.6
CPC3710C	250	220	10	-1.6	-3.9
CPC3714C	350	240	14	-1.6	-3.9
CPC3720C	350	130	22	-1.6	-3.9
CPC3730C	350	140	35	-1.6	-3.9
CPC3909C	400	300	6	-1.4	-3.1



SOT-223

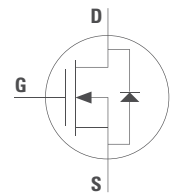

Part Number	$V_{(BR)DSX}$ (V)	I_D Min (mA)	$R_{DS(on)}$ Max (Ω)	$V_{GS(off)}$ Min (V)	$V_{GS(off)}$ Max (V)	Features & Comments
N-Channel Depletion Mode MOSFETs						
CPC3980Z	800	100	45	-1.4	-3.1	-
CPC3960Z	600	100	44	-1.4	-3.1	-
CPC3909Z	400	300	6	-1.4	-3.1	-
CPC5603C	415	130	14	-2	-3.6	Designed for use with LITELINK™ applications
CPC3708Z	350	130	14	-2	-3.6	-
CPC5602C	350	130	14	-2	-3.6	Designed for use with LITELINK™ applications
CPC3902Z	250	400	2.5	-1.4	-3.1	-



SOT-23

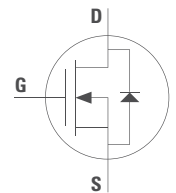

Part Number	$V_{(BR)DSX}$ (V)	I_D Min (mA)	$R_{DS(on)}$ Max (Ω)	$V_{GS(off)}$ Min (V)	$V_{GS(off)}$ Max (V)	Features & Comments
N-Channel Depletion Mode MOSFETs						
CPC3982T	800	20	380	-1.4	-3.1	Very small package



32-Pin SOIC

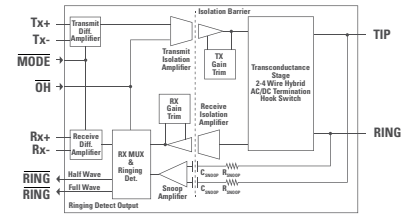

Part Number	Isolation Voltage (V _{RMS})	Power Supply (V)	Caller ID	Ringing Detect
LITELINK™ Galvanically Isolated Phone Line Interface				
CPC5622A	3000	3.3 - 5	Continuous	Half-wave & full-wave
CPC5621A			Selectable (CID=0)	Full-wave (CID=1)
CPC5620A			Selectable (CID=0)	Half-wave (CID=1)



28-Pin SOIC

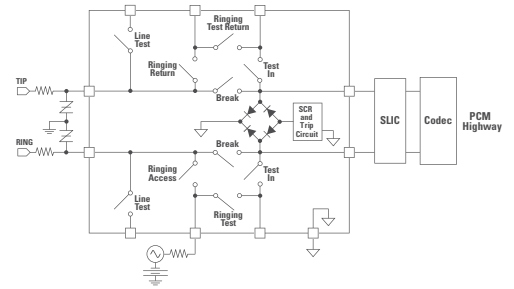

Part Number	Minimum 1500V/ μ s dV/dt	Switch Pairs						Zero-Cross Switching	Protection Features				Logic States
		# Switches	Break	Ringing	Line Test	Test In	Ringing Test		Current Limit	Diode Bridge	Protection SCR	Minimum Hold Current (mA)	
Line Card Access Switch (LCAS)													
CPC7695B	•	10	•	•	•	•	•	•	•	•	•	110	9



20-Pin SOIC

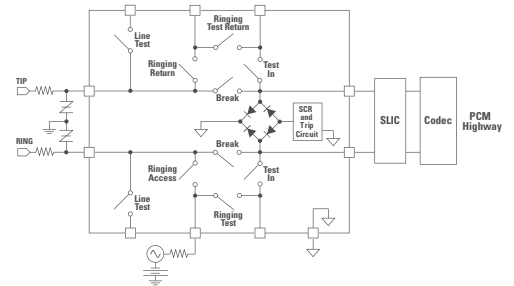

Part Number	Minimum 1500V/ μ s dV/dt	Switch Pairs						Zero-Cross Switching	Protection Features				Logic States
		# Switches	Break	Ringing	Line Test	Test In	Ringing Test		Current Limit	Diode Bridge	Protection SCR	Minimum Hold Current (mA)	
Line Card Access Switch (LCAS)													
CPC7695Z	•	10	•	•	•	•	•	•	•	•	•	110	9

Multifunction Products: SSR/Optocouplers



16-Pin SOIC

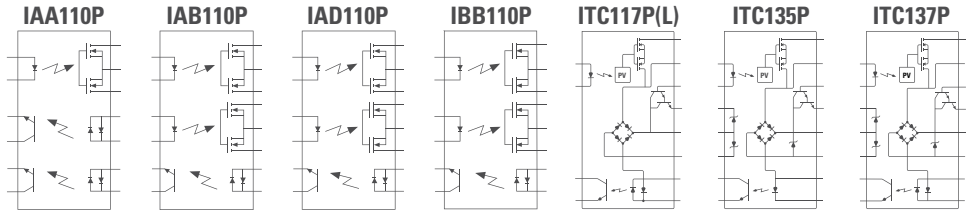

Part Number	SSR Characteristics				Optocoupler Characteristics				Isolation Voltage (V _{RMS})	Features & Comments
	Blocking Voltage (V _p)	Load Current (mA)	On Resistance (Ω)	Input Control Current (mA)	Breakdown Voltage (V)	Current Transfer Ratio (%)	Saturation Voltage (V)	Input Control Current (mA)		
General Purpose Multifunction Products										
IAA110P	350	100	35	5	20	33	0.5	6	3750	Two 1-Form-A relays, one optocoupler
IAB110P										One 1-Form-A relay, one 1-Form-B relay, one optocoupler
IAD110P										One 1-Form-A relay, two optocouplers
IBB110P										Two 1-Form-B relays, one optocoupler
Telecommunications Multifunction Products										
ITC117PL	350	120	15	5	20	33	0.5	6	3750	Full-wave ringing detect, current limiting
ITC117P			20							Full-wave ringing detect
ITC135P			15							Half-wave ringing detect
ITC137P			15							Full-wave ringing detect



8-Pin DIP

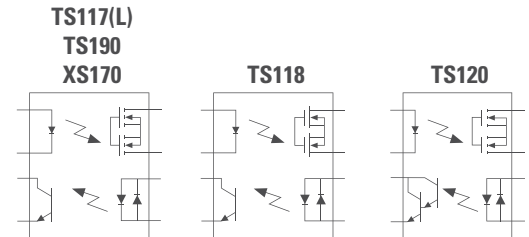

Part Number	SSR Characteristics				Optocoupler Characteristics				Isolation Voltage (V _{RMS})	Features & Comments
	Blocking Voltage (V _p)	Load Current (mA)	On Resistance (Ω)	Input Control Current (mA)	Breakdown Voltage (V)	Current Transfer Ratio (%)	Saturation Voltage (V)	Input Control Current (mA)		
General Purpose Multifunction Products										
TS190	400	150	22	5	20	33	0.5	6	3750	One 1-Form-A relay, one optocoupler
XS170	350	100	50	2		33	0.5	6		One 1-Form-A relay, one Darlington optocoupler
TS120	350	120	35	5		300	0.8	2		One 1-Form-A relay, one optocoupler
TS118	350	120	35	5		33	0.5	6		One 1-Form-B relay, one optocoupler
TS117	350	120	35	2		33	0.5	6		One 1-Form-A relay, one optocoupler
TS117L	350	120	35	2		33	0.5	6		One current-limiting 1-Form-A relay, one optocoupler

Multifunction Products: SSR/Optocouplers



8-Pin Flatpack

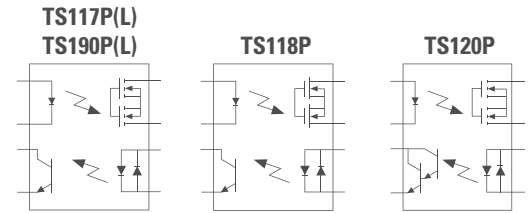

Part Number	SSR Characteristics				Optocoupler Characteristics				Isolation Voltage (V _{RMS})	Features & Comments
	Blocking Voltage (V _p)	Load Current (mA)	On Resistance (Ω)	Input Control Current (mA)	Breakdown Voltage (V)	Current Transfer Ratio (%)	Saturation Voltage (V)	Input Control Current (mA)		
General Purpose Multifunction Products										
TS190PL	400	150	25	5	20	33	0.5	6	3750	One current-limiting 1-Form-A relay, one optocoupler
TS190P	400	150	22	5		33	0.5	6		One 1-Form-A relay, one optocoupler
TS120P	350	120	35	5		300	0.8	2		One 1-Form-A relay, one Darlington optocoupler
TS118P	350	120	35	5		33	0.5	6		One 1-Form-B relay, one optocoupler
TS117P	350	120	35	2		33	0.5	6		One 1-Form-A relay, one optocoupler
TS117PL	350	120	35	2		33	0.5	6		One current-limiting 1-Form-A relay, one optocoupler



8-Pin Surface Mount

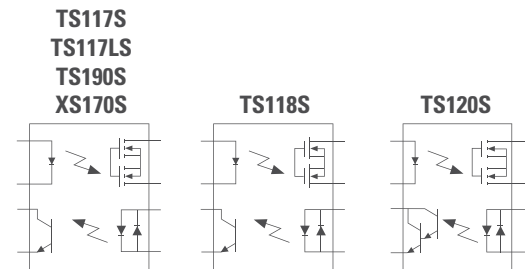

Part Number	SSR Characteristics				Optocoupler Characteristics				Isolation Voltage (V _{RMS})	Features & Comments
	Blocking Voltage (V _p)	Load Current (mA)	On Resistance (Ω)	Input Control Current (mA)	Breakdown Voltage (V)	Current Transfer Ratio (%)	Saturation Voltage (V)	Input Control Current (mA)		
General Purpose Multifunction Products										
TS190S	400	150	22	5	20	33	0.5	6	3750	One 1-Form-A relay, one optocoupler
XS170S	350	100	50	2		33	0.5	6		
TS117S	350	120	35	2		33	0.5	6		One 1-Form-A relay, one Darlington optocoupler
TS120S	350	120	35	5		300	0.8	2		
TS190LS	400	150	25	5		33	0.5	6		
TS117LS	350	120	35	2		33	0.5	6		
TS118S	350	120	35	5	33	0.5	6	One 1-Form-B relay, one optocoupler		



You need to be certain that your products live up to the highest standards for performance, reliability, safety, and regulatory compliance. Working with Littelfuse, you have access to dedicated application engineers who partner with you to provide expert design consultation, perform comprehensive tests simulating the harshest environments, and confidentially evaluate the results in consultation with you.

TESTING CAPABILITIES

Environmental

- Autoclave
- Dust
- H3TRB
- HAST
- High- & Low-Temperature Storage
- High-Temperature Loading
- Ingress Protection (IP)
- HTGB
- HTRB
- Temperature & Humidity
- Temperature Cycling
- Thermal Shock
- Salt Fog

Physical-Mechanical Characteristics

- Acceleration
- Die Shear
- Leak Detection
- Mechanical Shock
- Resistance to Soldering Heat (Dip, Reflow, Wave)
- Resistance to Solvents
- Solderability
- Terminal Strength (Push, Pull, Bend)
- Vibration
- Wetting Balance
- Wire Pull

Electrical

- BCI
- Capacitance
- EFT
- ESD
- Impedance
- Insulation Resistance
- I-V
- Life
- Lightning Surge
- Overload
- Parametric Tests
- Power-Cross
- Power Cycling
- Ring Wave
- R-T
- S-Parameter Measurements (Insertion Loss, Isolation, Reflection)
- Short Circuit
- Step Current
- Surface Resistivity
- Surge
- TDR (Eye Diagram)
- Telecom
- Thermal Cut-Off
- Time-to-Trip
- TLP
- Transient
- Trip Cycle
- Trip Endurance
- Voltage Drop



Scan to download

To access this guide and other **Littelfuse** literature in an interactive and mobile-friendly format, please visit our **eCatalog** library.



LOCAL RESOURCES FOR A GLOBAL MARKET

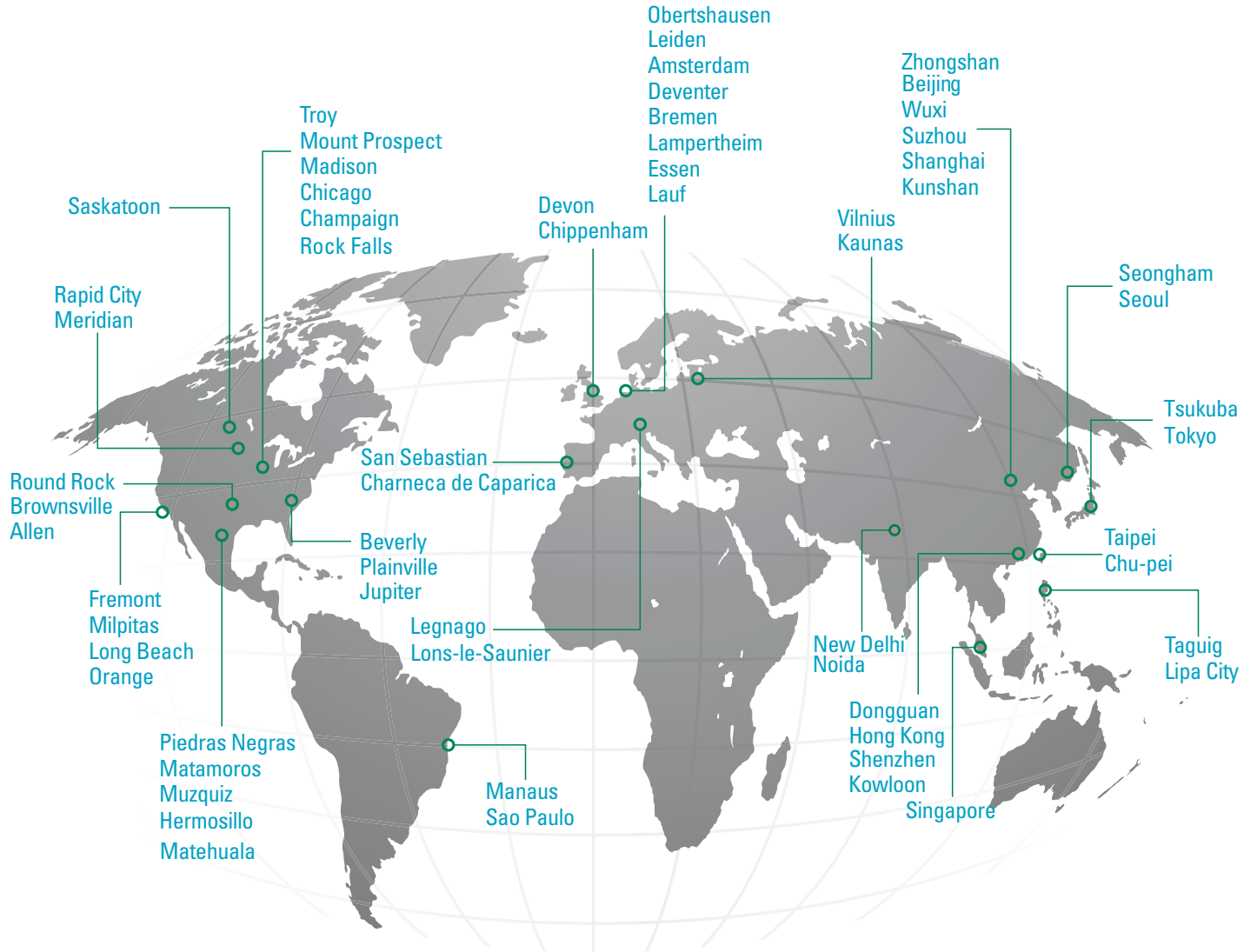

Expertise Applied | Answers Delivered