

ILC5061

Power Supply reset Monitor with 1% Precision

Features

- All-CMOS design in SOT-23 or SC70 package
- $\pm 1\%$ precision in Reset Detection
- Only $1\mu\text{A}$ of I_q
- 2mA of sink current capability
- Built-in hysteresis of 5% of detection voltage
- Voltage options of 2.6, 2.9, 3.1, 4.4, and 4.6V fit most supervisory applications
- Open-Drain Reset Output

Applications

- Microprocessor reset circuits
- Memory battery back-up circuitry
- Power-on reset circuits
- Portable and battery powered electronics

Description

All-CMOS Monitor circuits in either a 3-lead SOT-23 or SC70 package offer the best performance in power consumption and accuracy.

The ILC5061 comes in a series of $\pm 1\%$ accurate trip voltages to fit most microprocessor applications. Even though its output can sink 2mA, the device draws only $1\mu\text{A}$ in normal operation.

Additionally, a built-in hysteresis of 5% of detect voltage simplifies system design.

Block Diagram

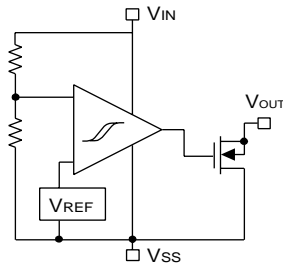

Pin Package Configurations

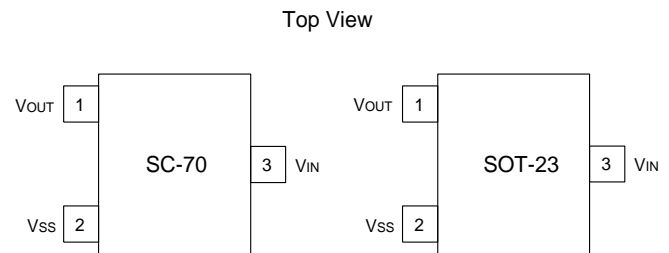

Absolute Maximum Ratings

Parameter		Symbol	Ratings	Units
Input Voltages		V_{IN}	12	V
Output Current		I_{OUT}	50	mA
Output Voltages		V_{OUT}	$V_{SS}-0.3\sim+V_{IN}+0.3$	V
Continuous Total Power Dissipation	SOT 23	P_d	150	mW
Operation Ambient temperature		T_{opr}	-30~+80	°C
Storage Temperature		T_{stg}	-40~+125	°C

Electrical Characteristics $T_A = 25^\circ\text{C}$

Parameter	Symbol	Conditions	Min	Type	Max	Units
Detect Fail Voltage	V_{DF}		$V_{DF} \times 0.99$	V_{DF}	$V_{DF} \times 1.01$	V
Hysteresis Range	V_{HYS}		$V_{DF} \times 0.02$	$V_{DF} \times 0.05$	$V_{DF} \times 0.08$	V
Supply Current	I_{SS}	$V_{IN} = 1.5\text{V}$ $V_{IN} = 2.0\text{V}$ $V_{IN} = 3.0\text{V}$ $V_{IN} = 4.0\text{V}$ $V_{IN} = 5.0\text{V}$		0.9 1.0 1.3 1.6 2.0	2.6 3.0 3.4 3.8 4.2	μA
Operating Voltage	V_{IN}	$V_{DF} = 2.1\sim 6.0\text{V}$	1.5		10.0	V
Output Current	I_{OUT}	N-ch $V_{DS} = 0.5\text{V}$ $V_{IN} = 1.0\text{V}$ $V_{IN} = 2.0\text{V}$ $V_{IN} = 3.0\text{V}$ $V_{IN} = 4.0\text{V}$ $V_{IN} = 5.0\text{V}$		2.2 7.7 10.1 11.5 13.0		mA
Temperature Characteristics	$DV_{DF}/(DT_{opr} * V_{DF})$	$-30^\circ\text{C} \leq T_{opr} \leq 80^\circ\text{C}$	-200	± 100	+200	Ppm/°C
Delay Time Release Voltage Output Inversion)	T_{DLY} (V_{DR} to V_{OUT} inversion)				0.1	ms

Note:

1. An additional resistor between the V_{IN} pin and supply voltage may cause deterioration of the characteristics due to increasing V_{DR} .

Functional Description

The following designators 1~6 refer to the timing diagram below.

1. While the input voltage (V_{IN}) is higher than the detect voltage (V_{DF}), the V_{OUT} output pin is at high impedance state.
2. When the input V_{IN} voltage falls lower than V_{DF} , V_{OUT} drops near to ground voltage
3. If the input voltage further decreases below the minimum operating voltage (V_{MIN}), the V_{OUT} output becomes unstable. In this condition, if the V_{OUT} pin is pulled up, V_{OUT} indicates the V_{IN} voltage.
4. During an increase of the input voltage from the V_{SS} voltage, V_{OUT} is not stable in the voltage below the V_{MIN} . Exceeding that level, the output stays at the ground level (V_{SS}) between the minimum operating voltage (V_{MIN}) and the detect release voltage (V_{DR}).
5. If the input voltage increases more than V_{DR} , then the V_{OUT} output pin is at high impedance state.
6. The difference between V_{DR} and V_{DF} is the hysteresis in the system.

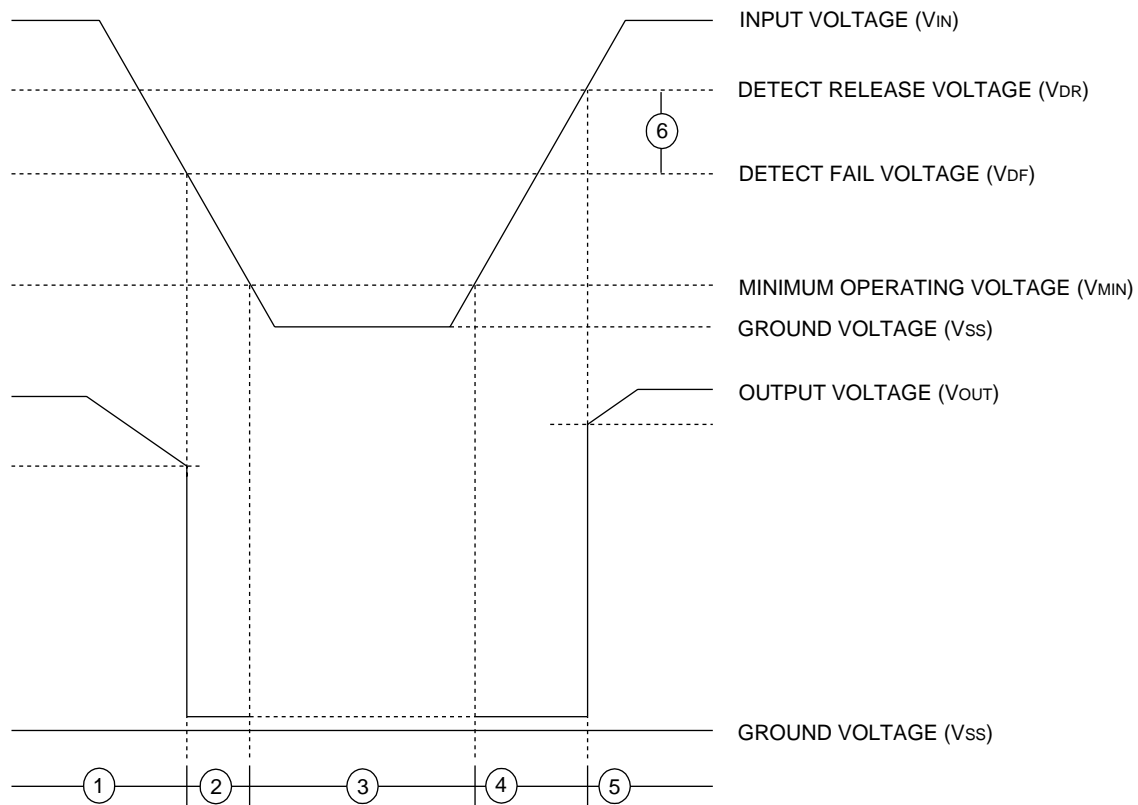

Typical Performance Characteristics (General conditions for all curves)

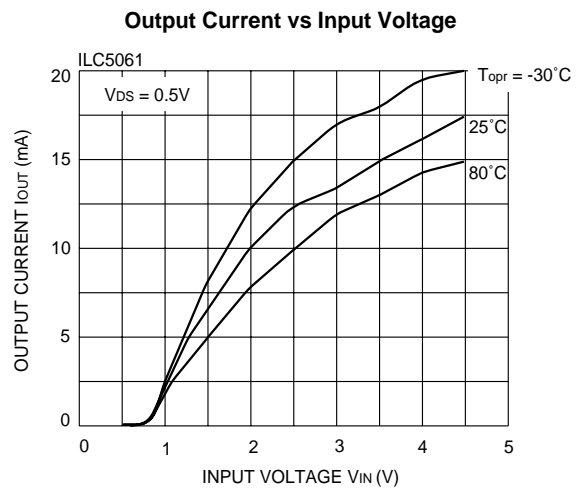
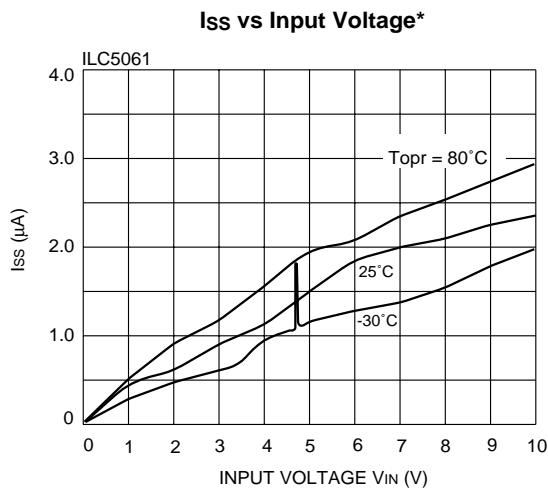
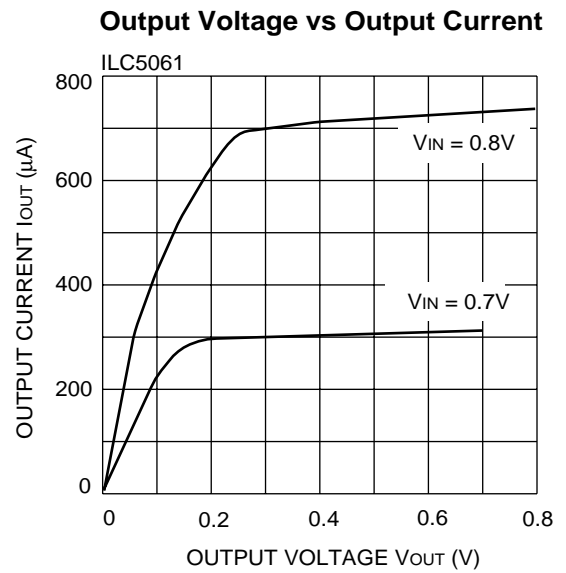
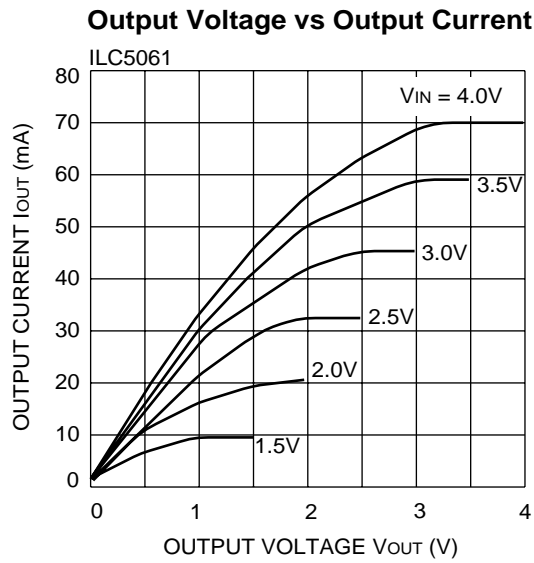

* A spike of 1/2 to 1 μ A may appear as V_{IN} crosses V_{DR} or V_{DF}

SOT-23 Package

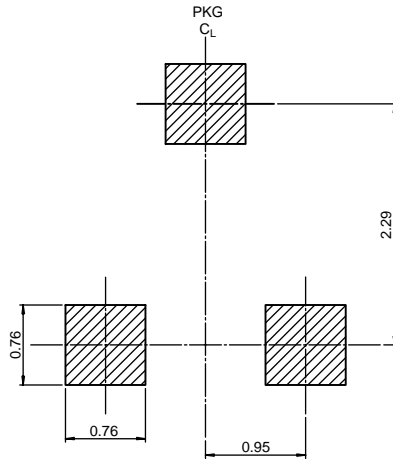
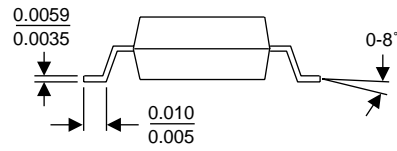
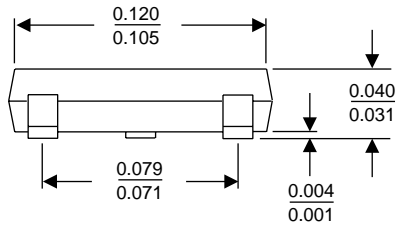
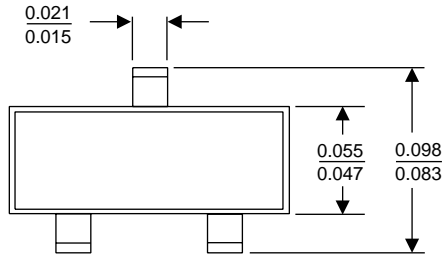

LAND PATTERN RECOMMENDATION

SC70 Package

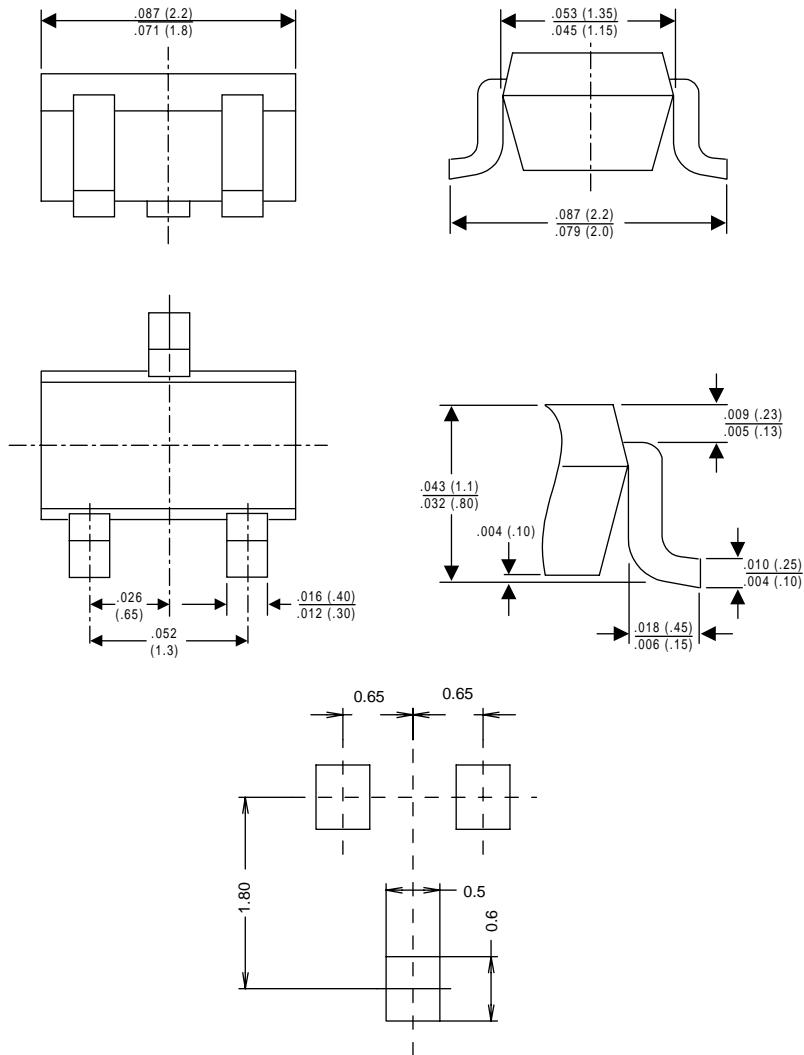

Land Pattern Recommendation

Ordering Information

PART NUMBER	TOP MARKING	RESET THRESHOLD (V)	OUTPUT TYPE	PACKAGE	PACKING METHOD
ILC5061AM23X	M3AY	2.3 ± 1 %	Open-Drain, active low	3-Pin, SOT23	3K units in T&R
ILC5061AM25X	M5AY	2.5 ± 1 %	Open-Drain, active low	3-Pin, SOT23	3K units in T&R
ILC5061AM26X	M6AY	2.6 ± 1 %	Open-Drain, active low	3-Pin, SOT23	3K units in T&R
ILC5061AM27X	M7AY	2.7 ± 1 %	Open-Drain, active low	3-Pin, SOT23	3K units in T&R
ILC5061AM28X	M8AY	2.8 ± 1 %	Open-Drain, active low	3-Pin, SOT23	3K units in T&R
ILC5061AM29X	M9AY	2.9 ± 1 %	Open-Drain, active low	3-Pin, SOT23	3K units in T&R
ILC5061AM31X	N1AY	3.1 ± 1 %	Open-Drain, active low	3-Pin, SOT23	3K units in T&R
ILC5061AM32X	N2AY	3.2 ± 1 %	Open-Drain, active low	3-Pin, SOT23	3K units in T&R
ILC5061AM34X	N4AY	3.4 ± 1 %	Open-Drain, active low	3-Pin, SOT23	3K units in T&R
ILC5061AM37X	N7AY	3.7 ± 1 %	Open-Drain, active low	3-Pin, SOT23	3K units in T&R
ILC5061AM44X	P4AY	4.4 ± 1 %	Open-Drain, active low	3-Pin, SOT23	3K units in T&R
ILC5061AM46X	P6AY	4.6 ± 1 %	Open-Drain, active low	3-Pin, SOT23	3K units in T&R
ILC5061M23X	M3Y	2.3 ± 2 %	Open-Drain, active low	3-Pin, SOT23	3K units in T&R
ILC5061M25X	M5Y	2.5 ± 2 %	Open-Drain, active low	3-Pin, SOT23	3K units in T&R
ILC5061M26X	M6Y	2.6 ± 2 %	Open-Drain, active low	3-Pin, SOT23	3K units in T&R
ILC5061M27X	M7Y	2.7 ± 2 %	Open-Drain, active low	3-Pin, SOT23	3K units in T&R
ILC5061M28X	M8Y	2.8 ± 2 %	Open-Drain, active low	3-Pin, SOT23	3K units in T&R
ILC5061M29X	M9Y	2.9 ± 2 %	Open-Drain, active low	3-Pin, SOT23	3K units in T&R
ILC5061M31X	N1Y	3.1 ± 2 %	Open-Drain, active low	3-Pin, SOT23	3K units in T&R
ILC5061M32X	N2Y	3.2 ± 2 %	Open-Drain, active low	3-Pin, SOT23	3K units in T&R
ILC5061M34X	N4Y	3.4 ± 2 %	Open-Drain, active low	3-Pin, SOT23	3K units in T&R
ILC5061M37X	N7Y	3.7 ± 2 %	Open-Drain, active low	3-Pin, SOT23	3K units in T&R
ILC5061M44X	P4Y	4.4 ± 2 %	Open-Drain, active low	3-Pin, SOT23	3K units in T&R
ILC5061M46X	P6Y	4.6 ± 2 %	Open-Drain, active low	3-Pin, SOT23	3K units in T&R

Note 1:Last digit in the "Top Marking" information (represented by "Y" in the above table) represents internal assembly lot number

Note 2:Orientation of Tape & Reeled devices is Right.

Ordering Information

PART NUMBER	TOP MARKING	RESET THRESHOLD (V)	OUTPUT TYPE	PACKAGE	PACKING METHOD
ILC5061AIC23X	M3AY	2.3 ± 1 %	Open-Drain, active low	3-Pin, SC70	3K units in T&R
ILC5061AIC25X	M5AY	2.5 ± 1 %	Open-Drain, active low	3-Pin, SC70	3K units in T&R
ILC5061AIC26X	M6AY	2.6 ± 1 %	Open-Drain, active low	3-Pin, SC70	3K units in T&R
ILC5061AIC27X	M7AY	2.7 ± 1 %	Open-Drain, active low	3-Pin, SC70	3K units in T&R
ILC5061AIC28X	M8AY	2.8 ± 1 %	Open-Drain, active low	3-Pin, SC70	3K units in T&R
ILC5061AIC29X	M9AY	2.9 ± 1 %	Open-Drain, active low	3-Pin, SC70	3K units in T&R
ILC5061AIC31X	N1AY	3.1 ± 1 %	Open-Drain, active low	3-Pin, SC70	3K units in T&R
ILC5061AIC32X	N2AY	3.2 ± 1 %	Open-Drain, active low	3-Pin, SC70	3K units in T&R
ILC5061AIC34X	N4AY	3.4 ± 1 %	Open-Drain, active low	3-Pin, SC70	3K units in T&R
ILC5061AIC37X	N7AY	3.7 ± 1 %	Open-Drain, active low	3-Pin, SC70	3K units in T&R
ILC5061AIC44X	P4AY	4.4 ± 1 %	Open-Drain, active low	3-Pin, SC70	3K units in T&R
ILC5061AIC46X	P6AY	4.6 ± 1 %	Open-Drain, active low	3-Pin, SC70	3K units in T&R
ILC5061IC23X	M3Y	2.3 ± 2 %	Open-Drain, active low	3-Pin, SC70	3K units in T&R
ILC5061IC25X	M5Y	2.5 ± 2 %	Open-Drain, active low	3-Pin, SC70	3K units in T&R
ILC5061IC26X	M6Y	2.6 ± 2 %	Open-Drain, active low	3-Pin, SC70	3K units in T&R
ILC5061IC27X	M7Y	2.7 ± 2 %	Open-Drain, active low	3-Pin, SC70	3K units in T&R
ILC5061IC28X	M8Y	2.8 ± 2 %	Open-Drain, active low	3-Pin, SC70	3K units in T&R
ILC5061IC29X	M9Y	2.9 ± 2 %	Open-Drain, active low	3-Pin, SC70	3K units in T&R
ILC5061IC31X	N1Y	3.1 ± 2 %	Open-Drain, active low	3-Pin, SC70	3K units in T&R
ILC5061IC32X	N2Y	3.2 ± 2 %	Open-Drain, active low	3-Pin, SC70	3K units in T&R
ILC5061IC34X	N4Y	3.4 ± 2 %	Open-Drain, active low	3-Pin, SC70	3K units in T&R
ILC5061IC37X	N7Y	3.7 ± 2 %	Open-Drain, active low	3-Pin, SC70	3K units in T&R
ILC5061IC44X	P4Y	4.4 ± 2 %	Open-Drain, active low	3-Pin, SC70	3K units in T&R
ILC5061IC46X	P6Y	4.6 ± 2 %	Open-Drain, active low	3-Pin, SC70	3K units in T&R

Note 1: Last digit in the "Top Marking" information (represented by "Y" in the above table) represents internal assembly lot number

Note 2: Orientation of Tape & Reeled devices is Right.

DISCLAIMER

FAIRCHILD SEMICONDUCTOR RESERVES THE RIGHT TO MAKE CHANGES WITHOUT FURTHER NOTICE TO ANY PRODUCTS HEREIN TO IMPROVE RELIABILITY, FUNCTION OR DESIGN. FAIRCHILD DOES NOT ASSUME ANY LIABILITY ARISING OUT OF THE APPLICATION OR USE OF ANY PRODUCT OR CIRCUIT DESCRIBED HEREIN; NEITHER DOES IT CONVEY ANY LICENSE UNDER ITS PATENT RIGHTS, NOR THE RIGHTS OF OTHERS.

LIFE SUPPORT POLICY

FAIRCHILD'S PRODUCTS ARE NOT AUTHORIZED FOR USE AS CRITICAL COMPONENTS IN LIFE SUPPORT DEVICES OR SYSTEMS WITHOUT THE EXPRESS WRITTEN APPROVAL OF THE PRESIDENT OF FAIRCHILD SEMICONDUCTOR CORPORATION. As used herein:

1. Life support devices or systems are devices or systems which, (a) are intended for surgical implant into the body, or (b) support or sustain life, and (c) whose failure to perform when properly used in accordance with instructions for use provided in the labeling, can be reasonably expected to result in a significant injury of the user.
2. A critical component in any component of a life support device or system whose failure to perform can be reasonably expected to cause the failure of the life support device or system, or to affect its safety or effectiveness.