

**DESCRIPTION**

The MC34064 is an undervoltage sensing circuit designed specifically for use as a reset controller in microprocessor-based systems. It offers the designer an economical, space-efficient solution for low supply voltage detection when used in combination with a single pullup resistor. Adding one capacitor offers the functionality of a programmable delay time after power returns. The MC34064 consists of a temperature stable reference comparator with hysteresis, high-current clamping diode and open collector output stage capable of sinking up to 60mA. The MC34064's RESET output is specified to be fully functional at  $V_{IN}=1V$ . A major improvement over competing products is the glitch-free supply current during undervoltage detection. Competing products demand a step function increase in operating current during the time that you least want or need it: during power loss. See Product Highlight below.

**IMPORTANT:** For the most current data, consult MICROSEMI's website: <http://www.microsemi.com>

**KEY FEATURES**

- Monitors 5V Supplies ( $V_T = 4.6V$  Typ.)
- Outputs Fully Defined At  $V_{IN} = 1V$  (See Figure 1)
- Glitch-Free Supply Current During Switching (See Product Highlight)
- Ultra-Low Supply Current (500 $\mu$ A Max.)
- Temperature Compensated ICC For Extremely Stable Current Consumption
- $\mu$ P Reset Function Programmable With 1 External Resistor And Capacitor
- Comparator Hysteresis Prevents Output Oscillation
- Electrically Compatible With Motorola MC34064
- Pin-to-Pin Compatible With Motorola MC34064 / MC34164

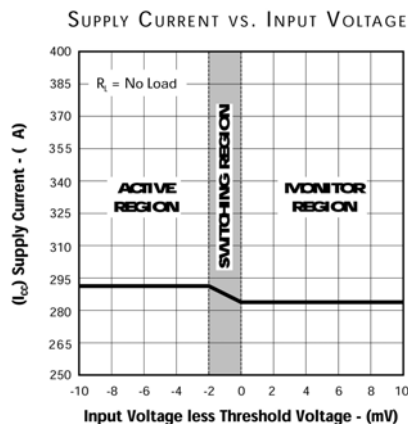
**PRODUCT HIGHLIGHT**

**APPLICATIONS**

- All Microprocessor Or Microcontroller Designs Using 5V Supplies
- Simple 5V Undervoltage Detection

**PACKAGE ORDER INFO**

$T_A$ (°C)	<b>DM</b> Plastic SOIC 8-Pin	<b>LP</b> Plastic TO-92 3-Pin	<b>PK</b> Plastic SOT-89 3-Pin
	RoHS / Pb-free Transition DC: 0440	RoHS / Pb-free Transition DC: 0509	RoHS / Pb-free Transition DC: 0518
0 to 70	<b>MC34064DM</b>	<b>MC34064LP</b>	<b>MC34064PK</b>
-40 to 85	<b>MC33064DM</b>	<b>MC33064LP</b>	<b>MC33064PK</b>

Note: Available in Tape & Reel. Append the letters "TR" to the part number. (i.e. LX34064DM-TR)

**Undervoltage Sensing Circuit**
**PRODUCTION DATA SHEET**
**ABSOLUTE MAXIMUM RATINGS**

Input Supply Voltage ( $V_{IN}$ )	-1V to 10V
RESET Output Voltage ( $V_{OUT}$ )	10V
Output Sink Current ( $I_{OL}$ )	Internally Limited (mA)
Clamp Diode Forward Current ( $I_F$ ), Pin 1 to Pin 2	100mA
Operating Temperature Range	150°C
Operating Ambient Temperature Range ( $T_A$ )	
MC34064	0°C to 70°C
MC33064	-40°C to 85°C
Storage Temperature Range	-65°C to 150°C
Package Peak Temp. for Solder Reflow (40 seconds maximum exposure)	260°C (+0 -5)

Note: Exceeding these ratings could cause damage to the device. All voltages are with respect to Ground. Currents are positive into, negative out of specified terminal.

**THERMAL DATA**
**DM** Plastic SOIC 8-Pin

THERMAL RESISTANCE-JUNCTION TO AMBIENT, $\theta_{JA}$	165°C/W
---	---------

**LP** Plastic TO-92 3-Pin

THERMAL RESISTANCE-JUNCTION TO AMBIENT, $\theta_{JA}$	156°C/W
---	---------

**PK** Plastic SOT-89 3-Pin

THERMAL RESISTANCE-JUNCTION TO TAB, $\theta_{JT}$	35°C/W
THERMAL RESISTANCE-JUNCTION TO AMBIENT, $\theta_{JA}$	71°C/W

Junction Temperature Calculation:  $T_J = T_A + (P_D \times \theta_{JA})$ .

The  $\theta_{JA}$  numbers are guidelines for the thermal performance of the device/pc-board system. All of the above assume no ambient airflow.

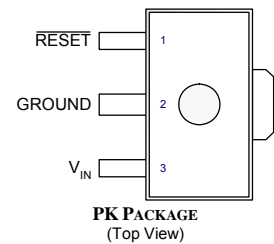
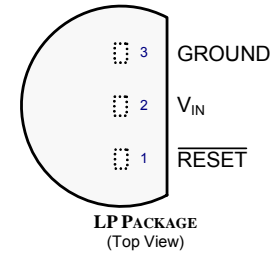
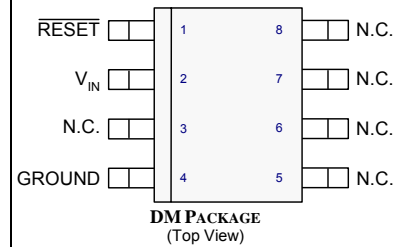
**PACKAGE PIN OUT**

RoHS / Pb-free 100% matte Tin Lead Finish

**RECOMMENDED OPERATING CONDITIONS**

Conditions: Range over which the device is functional.

Parameter	Symbol	MC3x064			Units
		Min	Typ	Max	
Input Supply Voltage	$V_{IN}$	1		6.5	V
RESET Output Voltage	$V_{OUT}$		6.5		V
Clamp Diode Forward Current	$I_F$		50		mA

**IC ELECTRICAL CHARACTERISTICS**

Unless otherwise specified, the following specifications apply over the operating ambient temperature  $0^{\circ}\text{C} \leq T_A \leq 70^{\circ}\text{C}$  for the MC34064 and  $-40^{\circ}\text{C} \leq T_A \leq 85^{\circ}\text{C}$  for the MC33064. Low duty cycle pulse testing techniques are used which maintains junction and case temperatures equal to the ambient temperature.

Parameter	Symbol	Test Conditions	MC3x064			Units
			Min	Typ	Max	
<b>COMPARATOR SECTION</b>						
Threshold Voltage						
High State Output	$V_{T+}$	$V_{IN}$ Increasing – 4V to 5V	4.5	4.61	4.7	V
Low State Outputs	$V_{T-}$	$V_{IN}$ Decreasing – 5V to 4V	4.5	4.59	4.7	V
Hysteresis	$V_H$		0.01	0.02	0.05	V
<b>RESET OUTPUT SECTION</b>						
Output Low Level Saturation Voltage	$V_{OL}$	$V_{IN} = 4.0\text{V}, I_{OL} = 8.0\text{mA}$			1.0	V
		$V_{IN} = 4.0\text{V}, I_{OL} = 2.0\text{mA}$			0.4	V
		$V_{IN} = 1.0\text{V}, I_{OL} = 0.1\text{mA}$			0.1	V
Output Low Level Current	$I_{OL}$	$V_{IN} = V_{OUT} = 4.0\text{V}$	10	27	60	mA
Output Off-State Leakage	$I_{OH}$	$V_{IN} = V_{OUT} = 5.0\text{V}$		0.02	0.5	$\mu\text{A}$
Clamp Diode Forward Voltage	$V_F$	Pin 1 to Pin 2, $I_F = 10\text{mA}$	0.6	0.9	1.2	V
<b>TOTAL DEVICE</b>						
Supply Current	$I_{CC}$	$V_{IN} = 5.0\text{V}$		390	500	$\mu\text{A}$

**CHART AND APPLICATION INDEX**
**Characteristic Curves**

- Figure #
- Input Voltage and  $\overline{\text{RESET}}$  Output Voltage vs. Time
  - Power-Up  $\overline{\text{RESET}}$  Voltage
  - Power-Down  $\overline{\text{RESET}}$  Voltage
  - $\overline{\text{RESET}}$  Output Voltage vs. Input Voltage
  - Threshold Voltage vs. Temperature
  - Threshold Hysteresis vs. Temperature
  - Supply Current vs. Input Voltage
  - Supply Current vs. Temperature
  - Low Level Output Current vs. Temperature
  - Low Level Output Saturation Voltage vs. Temperature
  - Low Level Output Saturation Voltage vs. Temperature
  - Clamp Diode Forward Voltage vs. Forward Current
  - Propagation Delay – HIGH to LOW
  - Propagation Delay – LOW to HIGH

**Application Circuits**

- Figure #
- Low Voltage Microprocessor Reset
  - Switching the Load off when Battery Reaches Below 4.3V
  - Voltage Monitor
  - MOSFET Low Voltage Gate Drive Protection
  - Low Voltage Microprocessor Reset with Additional Hysteresis
  - Solar Powered Battery



#### SIMPLIFIED BLOCK DIAGRAM

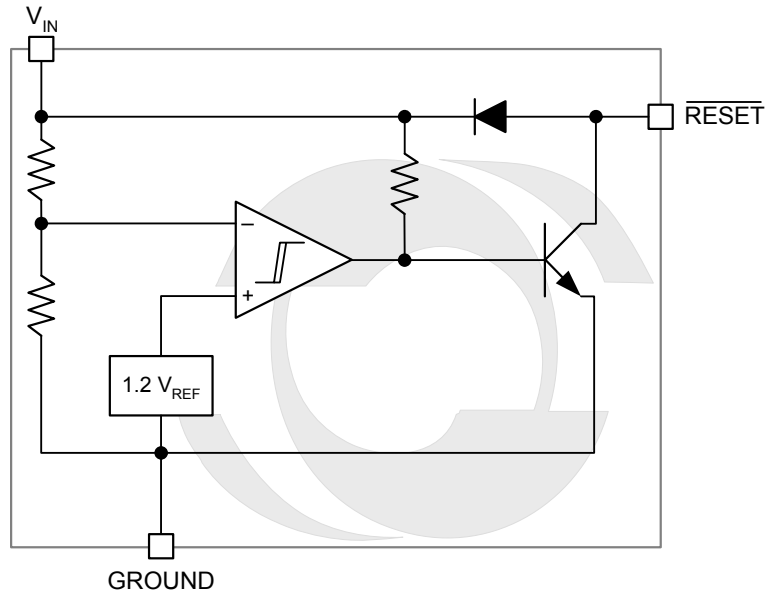

Simplified Block Diagram

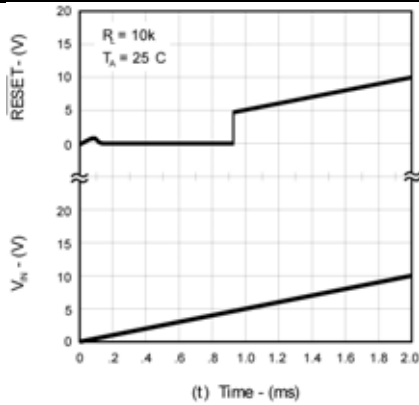
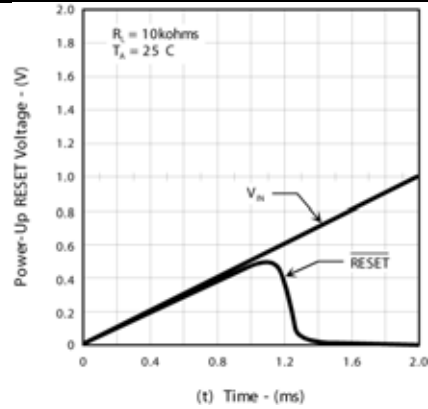
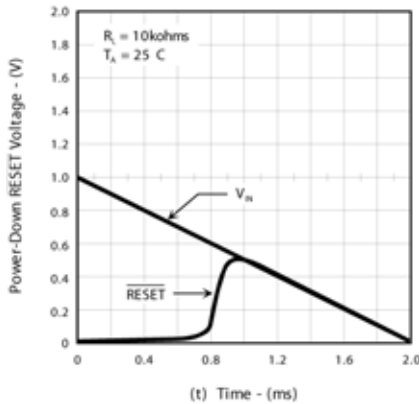
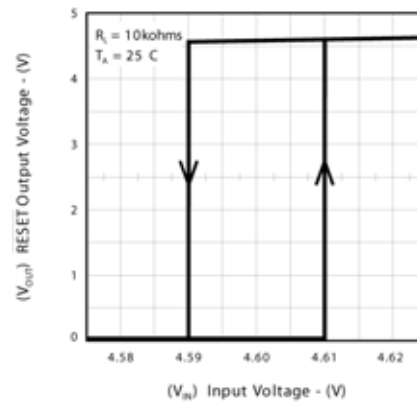
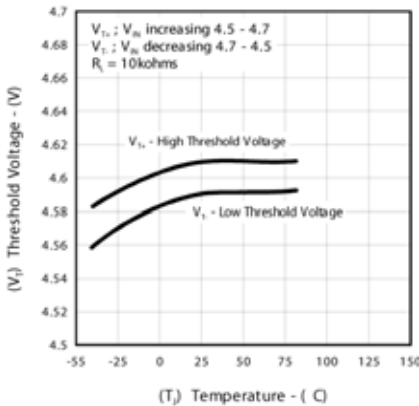
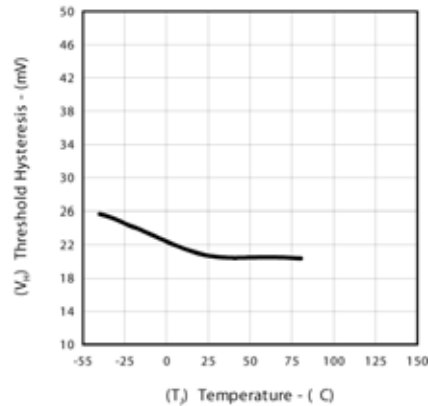
**CHARACTERISTIC CURVES**

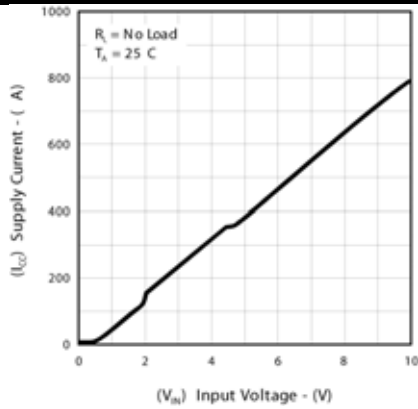
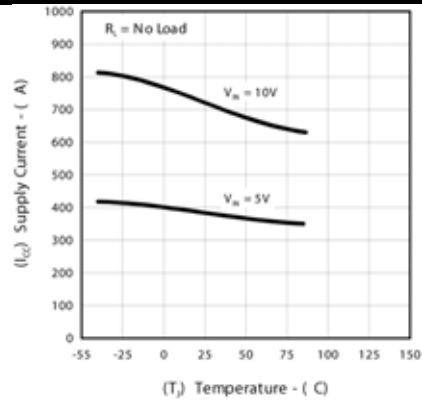
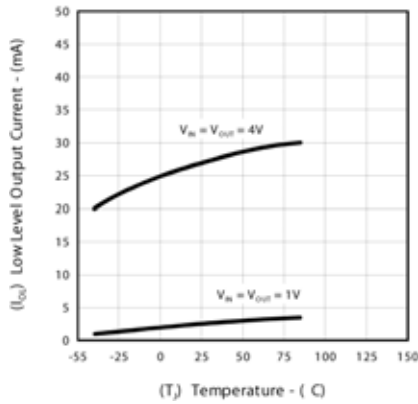
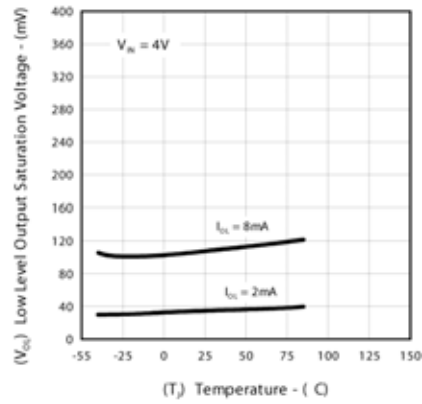
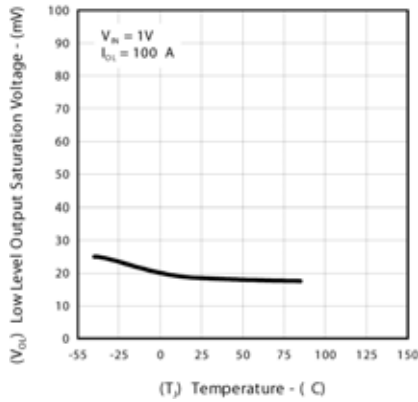
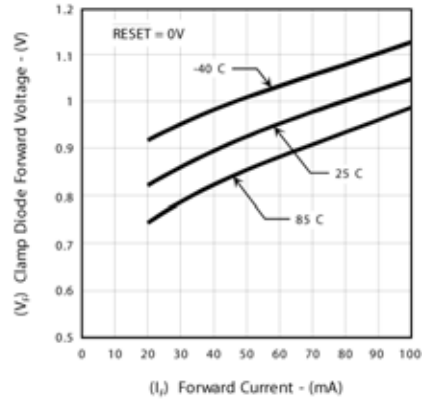
**Figure 1 – Input Voltage and  $\overline{\text{RESET}}$  Output Voltage vs. Time**

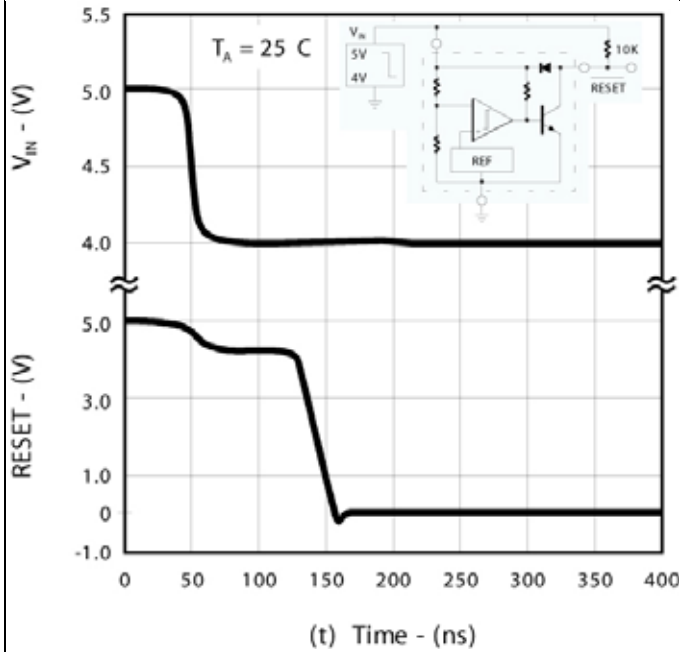
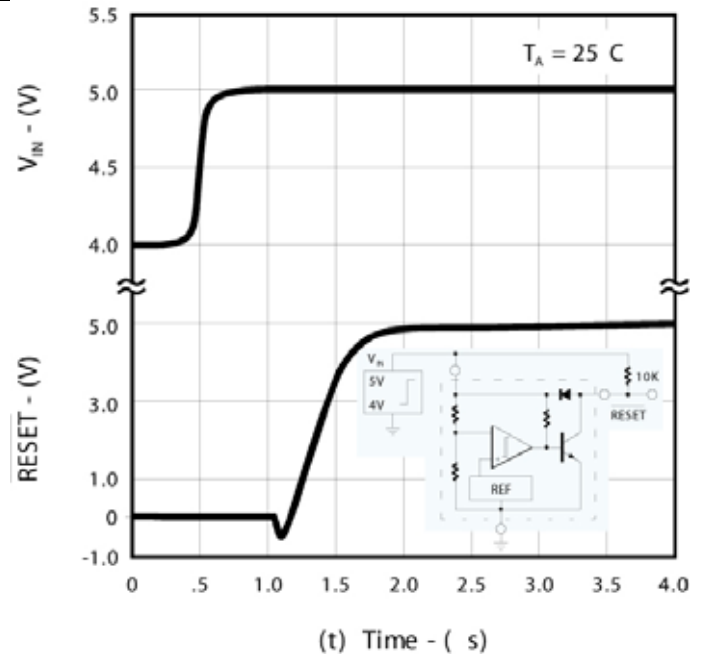
**Figure 2 – Power-Up  $\overline{\text{RESET}}$  Voltage**

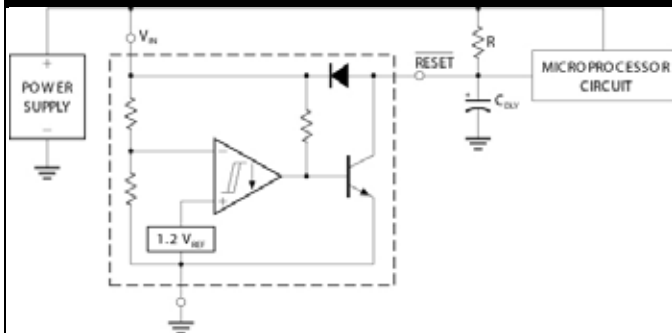
**Figure 3 – Power-Down  $\overline{\text{RESET}}$  Voltage**

**Figure 4 –  $\overline{\text{RESET}}$  Output Voltage vs. Input Voltage**

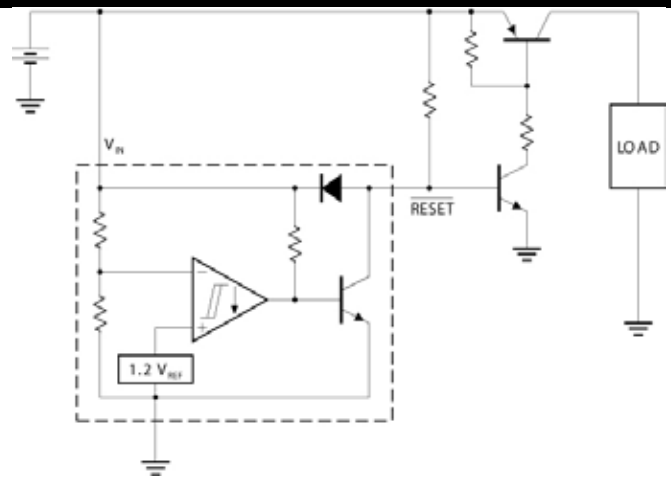
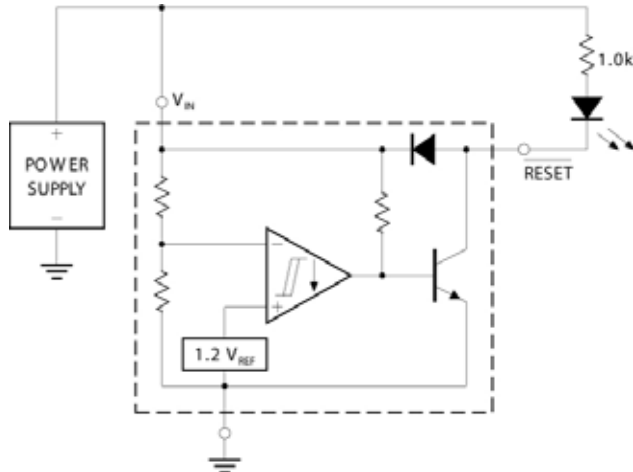
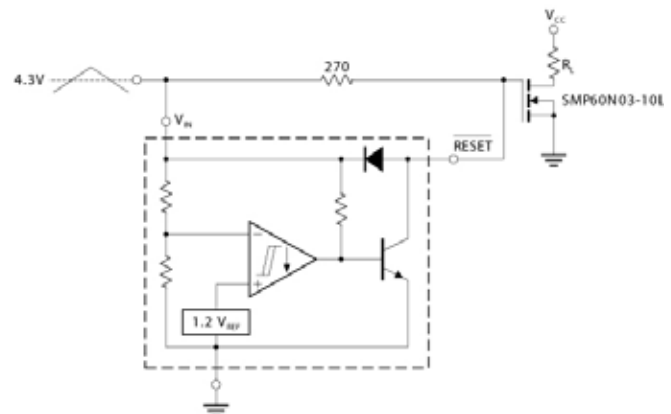
**Figure 5 – Threshold Voltage vs. Temperature**

**Figure 6 – Threshold Hysteresis vs. Temperature**

**CHARACTERISTIC CURVES**

**Figure 7 – Supply Current vs. Input Voltage**

**Figure 8 – Supply Current vs. Temperature**

**Figure 9 – Low Level Output Current vs. Temperature**

**Figure 10 – Low Level Output Saturation Voltage vs. Temperature**

**Figure 11 – Low Level Output Saturation Voltage vs. Temperature**

**Figure 12 – Clamp Diode Forward Voltage vs. Forward Current**

**CHARACTERISTIC CURVES**

**Figure 13 – Propagation Delay – HIGH to LOW**

**Figure 14 – Propagation Delay – LOW to HIGH**

**TYPICAL APPLICATION CIRCUITS**

**Figure 15 – Low Voltage Microprocessor Reset**

A time delayed reset can be accomplished with the addition of  $C_{DLY}$ . For systems with extremely fast power supply rise times (<500ns) it is recommended that the  $RC_{DLY}$  time constant be greater than  $5.0\mu s$ .  $V_{TH(MPU)}$  is the microprocessor reset input threshold.

**Figure 16 – Switching the Load off When battery Reaches Below 4.3V**

**Figure 17 – Voltage Monitor**

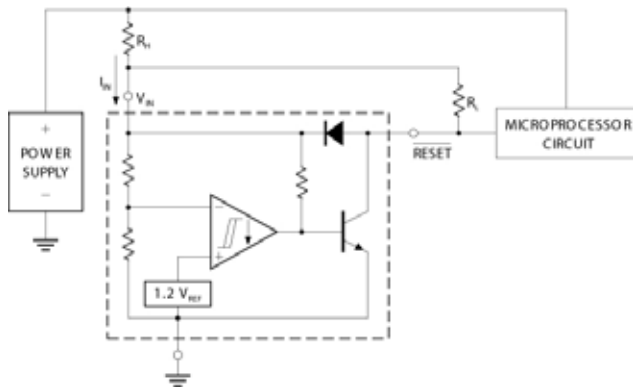
**Figure 18 – MOSFET Low Voltage gate Drive Protection**

Overheating of the logic level power MOSFET due to insufficient gate voltage can be prevented with the above circuit. When the input signal is below the 4.6 volt threshold of the MC34064, its output grounds the gate of the L<sup>2</sup> MOSFET.



**TYPICAL APPLICATION CIRCUITS**

**Figure 19** – Low Voltage Microprocessor Reset with Additional Hysteresis.

$$V_H = \frac{4.6R_H}{R_L} + 0.02$$

$$V_{TH(LOWER)} = 340R_H \cdot 10^{-6}$$

Where:  $R_H = 150\Omega$   
 $R_L = 1.5\Omega = 10k\Omega$

Test Data			
VH (mV)	$\Delta V_{TH}$ (mV)	RH ( $\Omega$ )	RL ( $\Omega$ )
20	0	0	0
51	3.4	10	1.5
40	6.8	20	4.7
81	6.8	20	1.5
71	10	30	2.7
112	10	30	1.5
100	16	47	2.7
164	16	47	1.5
190	34	100	2.7
327	34	100	1.5
276	51	150	2.7
480	51	150	1.5

Comparator hysteresis can be increased with the addition of resistor  $R_H$ . The hysteresis equation has been simplified and does not account for the change of input current  $I_{IN}$  as  $V_{CC}$  crosses the comparator threshold. An increase of the lower threshold.  $\Delta V_{TH(LOWER)}$  will be observed due to  $I_{IN}$  which is typically  $340\mu A$  at  $4.59V$ . The equations are accurate to  $\pm 10\%$  with  $R_H$  less than  $150\Omega$  and  $R_L$  between  $1.5k\Omega$  and  $10k\Omega$ .

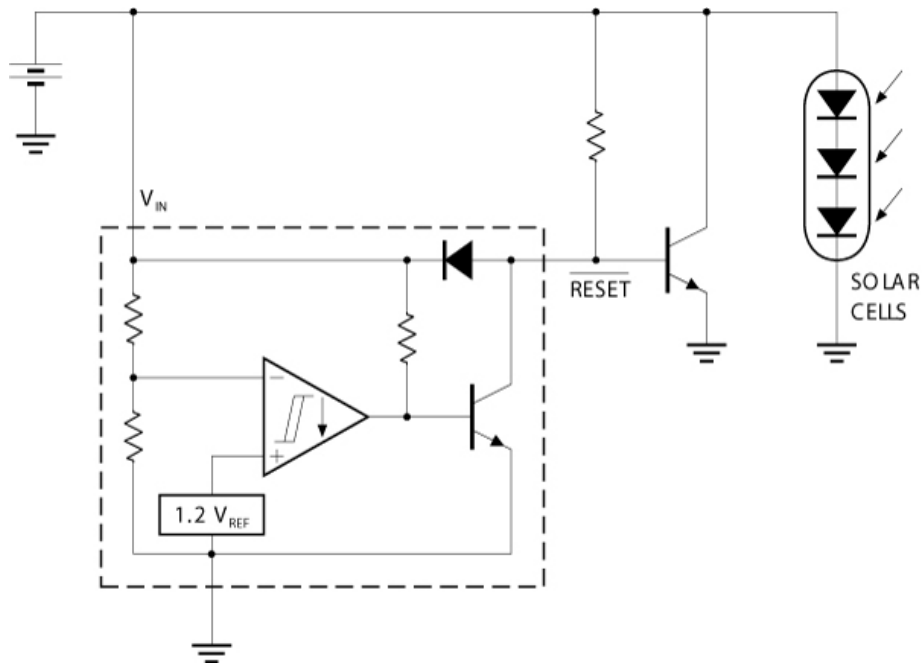

**Figure 20** – Solar Powered Battery Charger



**Microsemi**<sup>®</sup>

**MC33064 / MC34064**

**Undervoltage Sensing Circuit**

**PRODUCTION DATA SHEET**

**NOTES**

PRODUCTION DATA – Information contained in this document is proprietary to Microsemi and is current as of publication date. This document may not be modified in any way without the express written consent of Microsemi. Product processing does not necessarily include testing of all parameters. Microsemi reserves the right to change the configuration and performance of the product and to discontinue product at any time.