

FEATURES

- Simultaneously Monitors 5V, 3.3V and Adjustable Inputs
- Guaranteed Threshold Accuracy: $\pm 0.75\%$
- Low Supply Current: 100 μ A
- Internal Reset Time Delay: 200ms
- Manual Pushbutton Reset Input
- Active Low and Active High Reset Outputs
- Active Low “Soft” Reset Output
- Power Supply Glitch Immunity
- Guaranteed Reset for Either $V_{CC3} \geq 1V$ or $V_{CC5} \geq 1V$
- Meets PCI t_{FAIL} Timing Specifications Rev 2.1
- 8-Pin SO and MSOP Packages

APPLICATIONS

- PCI-Based Systems
- Desktop Computers
- Notebook Computers
- Intelligent Instruments
- Portable Battery-Powered Equipment
- Network Servers

DESCRIPTION

The LTC[®]1536 is designed for PCI local bus applications with multiple supply voltages that require low power, small size, high speed and high accuracy supply monitoring.

For 3.3V and 5V supplies that are >500mV below spec or for the condition when the 5V supply falls below the 3.3V supply, the LTC1536 has a very fast response time capable of meeting the PCI t_{FAIL} timing specification. Tight 0.75% threshold accuracy and glitch immunity ensure reliable reset operation without false triggering.

The \overline{RST} output is guaranteed to be in the correct state for V_{CC5} or V_{CC3} down to 1V. The 100 μ A typical supply current makes the LTC1536 ideal for power-conscious systems.

A manual pushbutton reset input provides the ability to generate a very narrow “soft” reset pulse (100 μ s typ) or a 200ms reset pulse equivalent to a power-on reset. Both \overline{SRST} and \overline{RST} outputs are open-drain and can be OR-tied with other reset sources.

LTC, LTC and LT are registered trademarks of Linear Technology Corporation. All other trademarks are the property of their respective owners.

TYPICAL APPLICATION

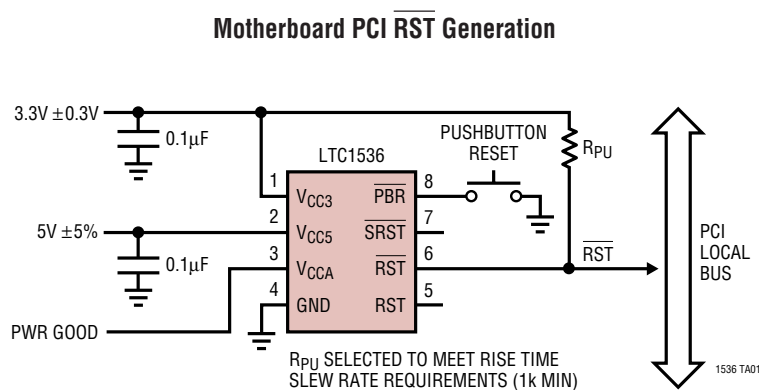

Power Fail Waveform
 5V Dropping Below 3.3V by 300mV

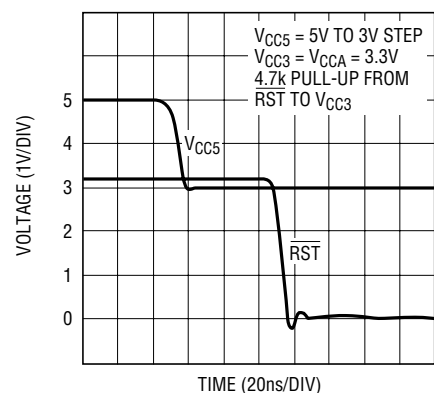

1536 TA02

ABSOLUTE MAXIMUM RATINGS (Notes 1, 2)

Terminal Voltage	Operating Temperature Range
$V_{CC3}, V_{CC5}, V_{CCA}$ -0.3V to 7V	LTC1536C 0°C to 70°C
$\overline{RST}, \overline{SRST}$ -0.3V to 7V	LTC1536I -40°C to 85°C
\overline{RST} -0.3V to $V_{CC3} + 0.3V$	Storage Temperature Range -65°C to 150°C
\overline{PBR} -7V to 7V	Lead Temperature (Soldering, 10 sec) 300°C

PACKAGE/ORDER INFORMATION

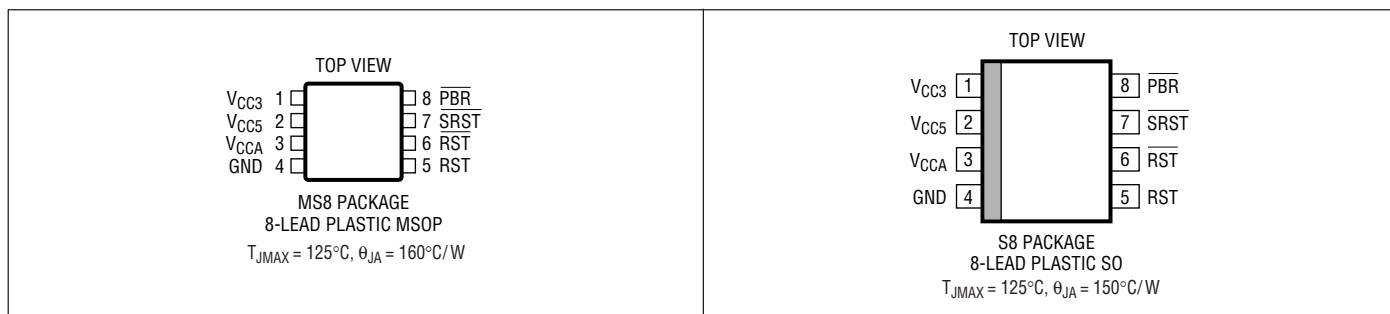

ORDER PART NUMBER	MS8 PART MARKING	ORDER PART NUMBER	S8 PART MARKING
LTC1536CMS8	LTBV	LTC1536CS8	1536
		LTC1536IS8	1536I

Order Options Tape and Reel: Add #TR
 Lead Free: Add #PBF Lead Free Tape and Reel: Add #TRPBF
 Lead Free Part Marking: <http://www.linear.com/leadfree/>

Consult LTC Marketing for parts specified with wider operating temperature ranges.

ELECTRICAL CHARACTERISTICS

The ● denotes the specifications which apply over the full operating temperature range, otherwise specifications are at $T_A = 25^\circ\text{C}$. $V_{CC3} = 3.3\text{V}$, $V_{CC5} = 5\text{V}$, $V_{CCA} = V_{CC3}$ unless otherwise noted.

SYMBOL	PARAMETER	CONDITIONS	MIN	TYP	MAX	UNITS	
V_{RT3}	Reset Threshold V_{CC3}	$0^\circ\text{C} \leq T_A \leq 70^\circ\text{C}$	●	2.962	2.985	3.000	V
		$-40^\circ\text{C} \leq T_A \leq 85^\circ\text{C}$	●	2.925	2.985	3.008	V
V_{RT5}	Reset Threshold V_{CC5}	$0^\circ\text{C} \leq T_A \leq 70^\circ\text{C}$	●	4.687	4.725	4.750	V
		$-40^\circ\text{C} \leq T_A \leq 85^\circ\text{C}$	●	4.625	4.725	4.762	V
V_{RTA}	Reset Threshold V_{CCA}	$0^\circ\text{C} \leq T_A \leq 70^\circ\text{C}$	●	0.992	1.000	1.007	V
		$-40^\circ\text{C} \leq T_A \leq 85^\circ\text{C}$	●	0.980	1.000	1.007	V
V_{CC}	V_{CC3} or V_{CC5} Operating Voltage	\overline{RST} in Correct Logic State	●	1	7	V	
I_{VCC3}	V_{CC3} Supply Current	$\overline{PBR} = V_{CC3}$	●	100	200	μA	
I_{VCC5}	V_{CC5} Input Current	$V_{CC5} = 5\text{V}$	●	10	20	μA	
I_{VCCA}	V_{CCA} Input Current	$V_{CCA} = 1\text{V}$	●	-15	0	nA	
t_{RST}	Reset Pulse Width	\overline{RST} Low with 10k Ω Pull-Up to V_{CC3}	●	140	200	280	ms
		0°C to 70°C -40°C to 85°C	●	140	200	300	ms
t_{SRST}	Soft Reset Pulse Width	\overline{SRST} Low with 10k Ω Pull-Up to V_{CC3}	●	50	100	200	μs
t_{UV}	V_{CC} Undervoltage Detect to \overline{RST}	V_{CC5}, V_{CC3} or V_{CCA} Less Than Reset Threshold V_{RT} by 1%		13		μs	

ELECTRICAL CHARACTERISTICS

The ● denotes the specifications which apply over the full operating temperature range, otherwise specifications are at $T_A = 25^\circ\text{C}$. $V_{CC3} = 3.3\text{V}$, $V_{CC5} = 5\text{V}$, $V_{CCA} = V_{CC3}$ unless otherwise noted.

SYMBOL	PARAMETER	CONDITIONS	MIN	TYP	MAX	UNITS		
I_{PBR}	PBR Pull-Up Current	$\overline{PBR} = 0\text{V}$, $0^\circ\text{C} \leq T_A \leq 70^\circ\text{C}$	●	3	7	10	μA	
		$\overline{PBR} = 0\text{V}$, $-40^\circ\text{C} \leq T_A \leq 85^\circ\text{C}$	●	3	7	15	μA	
V_{IL}	\overline{PBR} , \overline{RST} Input Low Voltage		●		0.8	V		
V_{IH}	\overline{PBR} , \overline{RST} Input High Voltage		●	2		V		
t_{PW}	\overline{PBR} Min Pulse Width		●	40		ns		
t_{DB}	\overline{PBR} Debounce	Deassertion of \overline{PBR} Input to \overline{SRST} Output (PBR Pulse Width = $1\mu\text{s}$)	●		20	35	ms	
t_{PB}	PBR Assertion Time for Transition from Soft to Hard Reset Mode	\overline{PBR} Held Less Than V_{IL} , 0°C to 70°C	●	1.4	2.0	2.8	s	
		\overline{PBR} Held Less Than V_{IL} , -40°C to 85°C	●	1.4	2.0	3.0	s	
V_{OL}	RST Output Voltage Low	$I_{SINK} = 5\text{mA}$	●		0.15	0.4	V	
		$I_{SINK} = 100\mu\text{A}$ $0^\circ\text{C} \leq T_A \leq 70^\circ\text{C}$	$V_{CC3} = 1\text{V}$, $V_{CC5} = 0\text{V}$	●		0.05	0.4	V
			$V_{CC3} = 0\text{V}$, $V_{CC5} = 1\text{V}$	●		0.05	0.4	V
			$V_{CC3} = 1\text{V}$, $V_{CC5} = 1\text{V}$	●		0.05	0.4	V
	$I_{SINK} = 100\mu\text{A}$ $-40^\circ\text{C} \leq T_A \leq 85^\circ\text{C}$	$V_{CC3} = 1.1\text{V}$, $V_{CC5} = 0\text{V}$	●		0.05	0.4	V	
		$V_{CC3} = 0\text{V}$, $V_{CC5} = 1.1\text{V}$ $V_{CC3} = 1.1\text{V}$, $V_{CC5} = 1.1\text{V}$	●		0.05	0.4	V	
	\overline{SRST} Output Voltage Low	$I_{SINK} = 2.5\text{mA}$	●		0.15	0.4	V	
	RST Output Voltage Low	$I_{SINK} = 2.5\text{mA}$	●		0.15	0.4	V	
V_{OH}	RST Output Voltage High (Note 3)	$I_{SOURCE} = 1\mu\text{A}$	●	$V_{CC3} - 1$			V	
	\overline{SRST} Output Voltage High (Note 3)	$I_{SOURCE} = 1\mu\text{A}$	●	$V_{CC3} - 1$			V	
	RST Output Voltage High	$I_{SOURCE} = 600\mu\text{A}$	●	$V_{CC3} - 1$			V	
t_{PHL}	Propagation Delay \overline{RST} to RST High Input to Low Output	$C_{RST} = 20\text{pF}$			25		ns	
t_{PLH}	Propagation Delay \overline{RST} to RST Low Input to High Output	$C_{RST} = 20\text{pF}$			45		ns	
t_{FAIL}	V_{CC5} or V_{CC3} 0.5V Undervoltage to \overline{RST} (Note 4)	V_{CC5} Drops Below 4.25V or V_{CC3} Drops Below 2.5V (Note 5)	●		150	450	ns	
t_{PF}	$V_{CC5} < (V_{CC3} - 300\text{mV})$ \overline{RST} (Note 4)	V_{CC5} Drops Below V_{CC3} By 300mV (Note 6)	●		50	90	ns	

Note 1: Stresses beyond those listed under Absolute Maximum Ratings may cause permanent damage to the device. Exposure to any Absolute Maximum Rating condition for extended periods may affect device reliability and lifetime.

Note 2: All voltage values are with respect to GND.

Note 3: The output pins \overline{SRST} and \overline{RST} have weak internal pull-ups to V_{CC3} of $6\mu\text{A}$. However, external pull-up resistors may be used when faster rise times are required.

Note 4: Conforms to PCI Local Bus Specification Rev 2.1, Sect. 4.3.2 for t_{FAIL} .

Note 5: V_{CC3} or V_{CC5} falling at $-0.1\text{V}/\mu\text{s}$, time measured from $V_{RTX} - 500\text{mV}$ to \overline{RST} at 1.5V.

Note 6: V_{CC5} falling from 5V to 3V in $\leq 10\text{ns}$, time measured from $V_{CC5} = (V_{CC3} - 300\text{mV})$ to \overline{RST} at 1.5V.

TYPICAL PERFORMANCE CHARACTERISTICS

I_{VCC3} vs Temperature

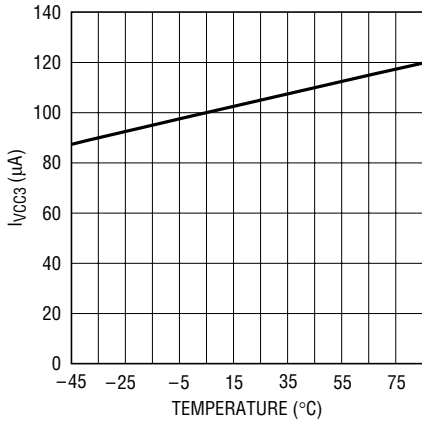

1536 G01

I_{VCC5} vs Temperature

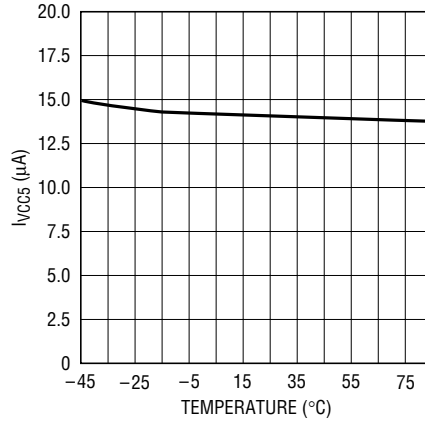

1536 G02

V_{CCA} Input Current vs Input Voltage

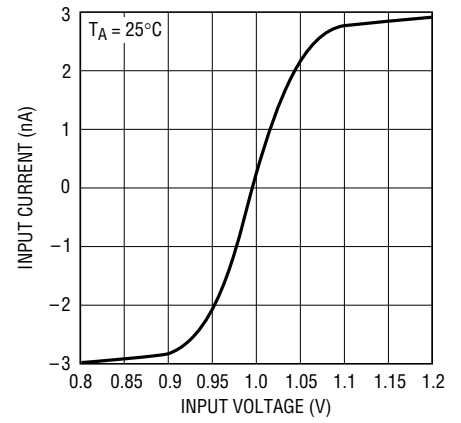

1536 G03

V_{CC5} Threshold Voltage vs Temperature

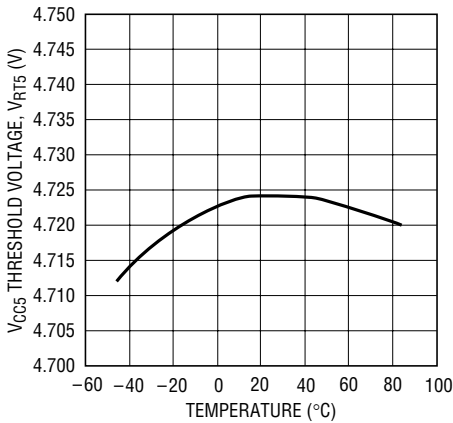

1536 G04

V_{CC3} Threshold Voltage vs Temperature

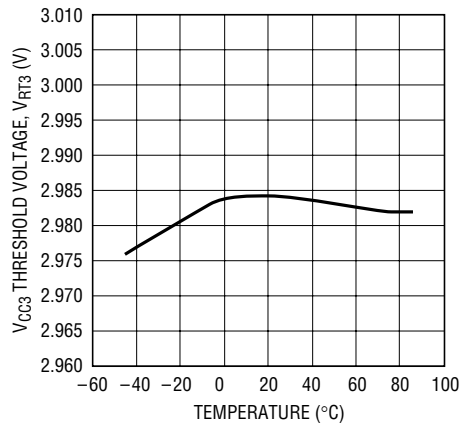

1536 G05

V_{CCA} Threshold Voltage vs Temperature

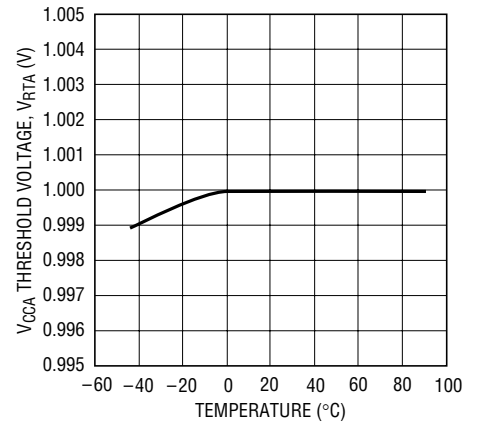

1536 G06

Reset Pulse Width vs Temperature

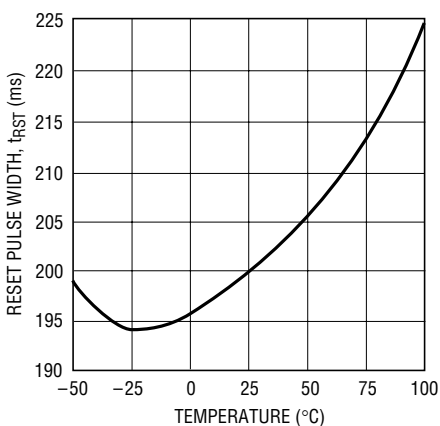

1536 G07

“Soft” Reset Pulse Width vs Temperature

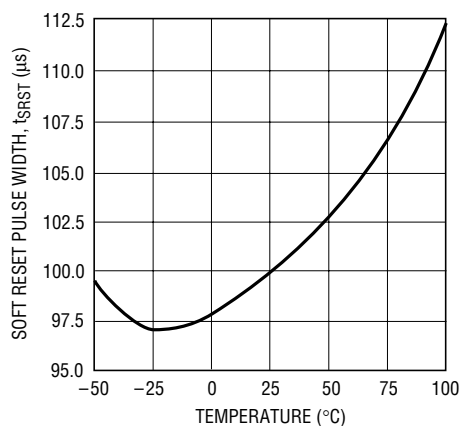

1536 G08

PBR Assertion Time to Reset vs Temperature

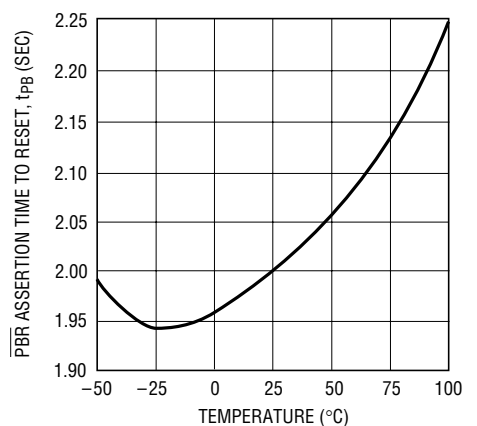

1536 G09

TYPICAL PERFORMANCE CHARACTERISTICS

V_{CC3} Typical Transient Duration vs Reset Comparator Overdrive

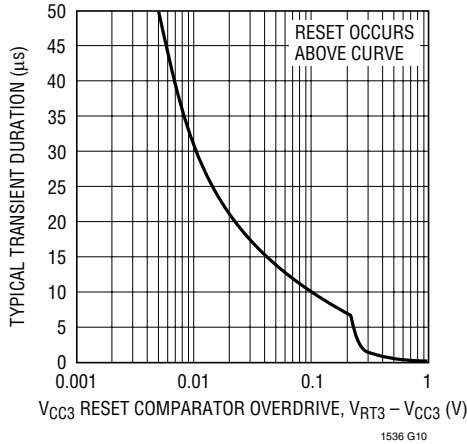

V_{CC5} Typical Transient Duration vs Reset Comparator Overdrive

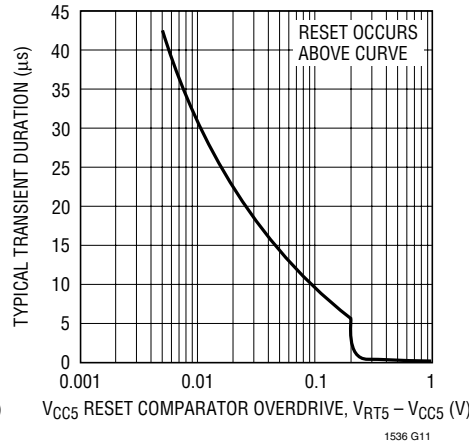

V_{CCA} Typical Transient Duration vs Reset Comparator Overdrive

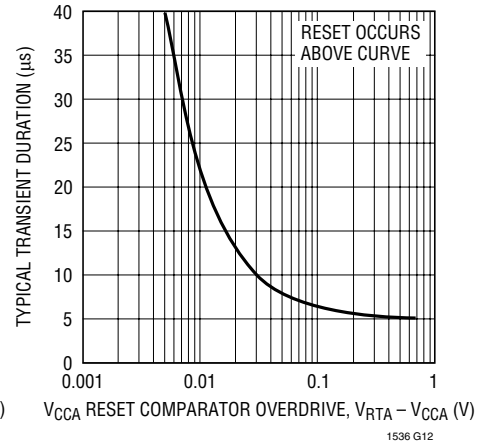

RST Output Voltage vs Supply Voltage

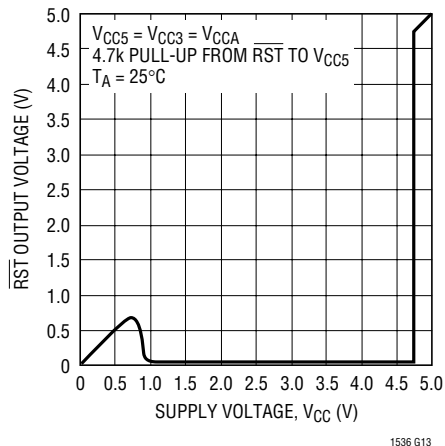

RST Output Voltage vs Supply Voltage

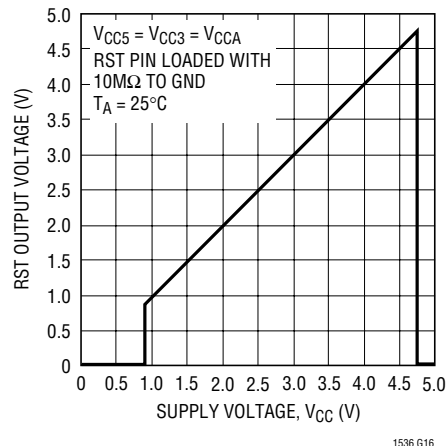

Undervoltage Response Time vs Temperature

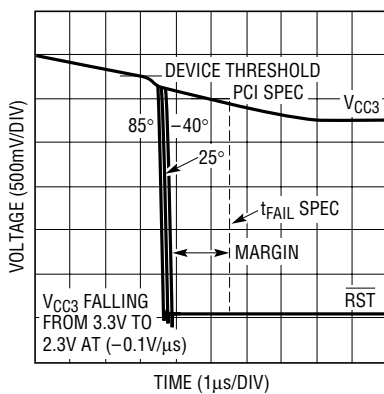

Power-Fail Response Time vs Temperature

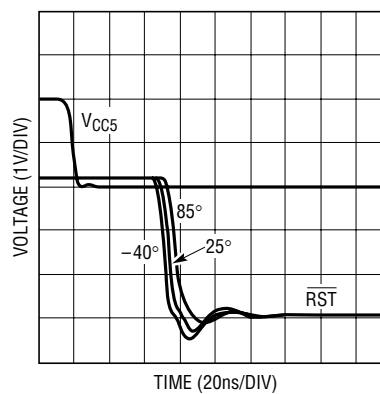

PIN FUNCTIONS

V_{CC3} (Pin 1): 3.3V Sense Input and Power Supply Pin for the IC. Bypass to ground with $\geq 0.1\mu\text{F}$ ceramic capacitor.

V_{CC5} (Pin 2): 5V Sense Input. Used as gate drive for $\overline{\text{RST}}$ output FET when the voltage on V_{CC5} is greater than the voltage on V_{CC3}.

V_{CCA} (Pin 3): 1V Sense, High Impedance Input. Can be used as a logic input with a 1V threshold. If unused it can be tied to either V_{CC3} or V_{CC5}.

GND (Pin 4): Ground.

RST (Pin 5): Reset Logic Output. Active high CMOS logic output, drives high to V_{CC3}, buffered compliment of $\overline{\text{RST}}$. An external pull-down on the $\overline{\text{RST}}$ pin will drive this pin high.

$\overline{\text{RST}}$ (Pin 6): Reset Logic Output. Active low, open-drain logic output with weak pull-up to V_{CC3}. Can be pulled up greater than V_{CC3} when interfacing to 5V logic.

Asserted when one or more of the supplies are below trip thresholds and held for 200ms after all supplies become valid. Also asserted after $\overline{\text{PBR}}$ is held low for more than two seconds and for an additional 200ms after $\overline{\text{PBR}}$ is released.

SRST (Pin 7): “Soft” Reset. Active low, open-drain logic output with weak pull-up to V_{CC3}. Can be pulled up greater than V_{CC3} when interfacing to 5V logic. Asserted for 100 μs after $\overline{\text{PBR}}$ is held low for less than two seconds and released.

$\overline{\text{PBR}}$ (Pin 8): Pushbutton Reset. Active low logic input with weak pull-up to V_{CC3}. Can be pulled up greater than V_{CC3} when interfacing to 5V logic. When asserted for less than two seconds, outputs a soft reset 100 μs pulse on the SRST pin. When $\overline{\text{PBR}}$ is asserted for greater than two seconds, the $\overline{\text{RST}}$ output is forced low and remains low until 200ms after $\overline{\text{PBR}}$ is released.

BLOCK DIAGRAM

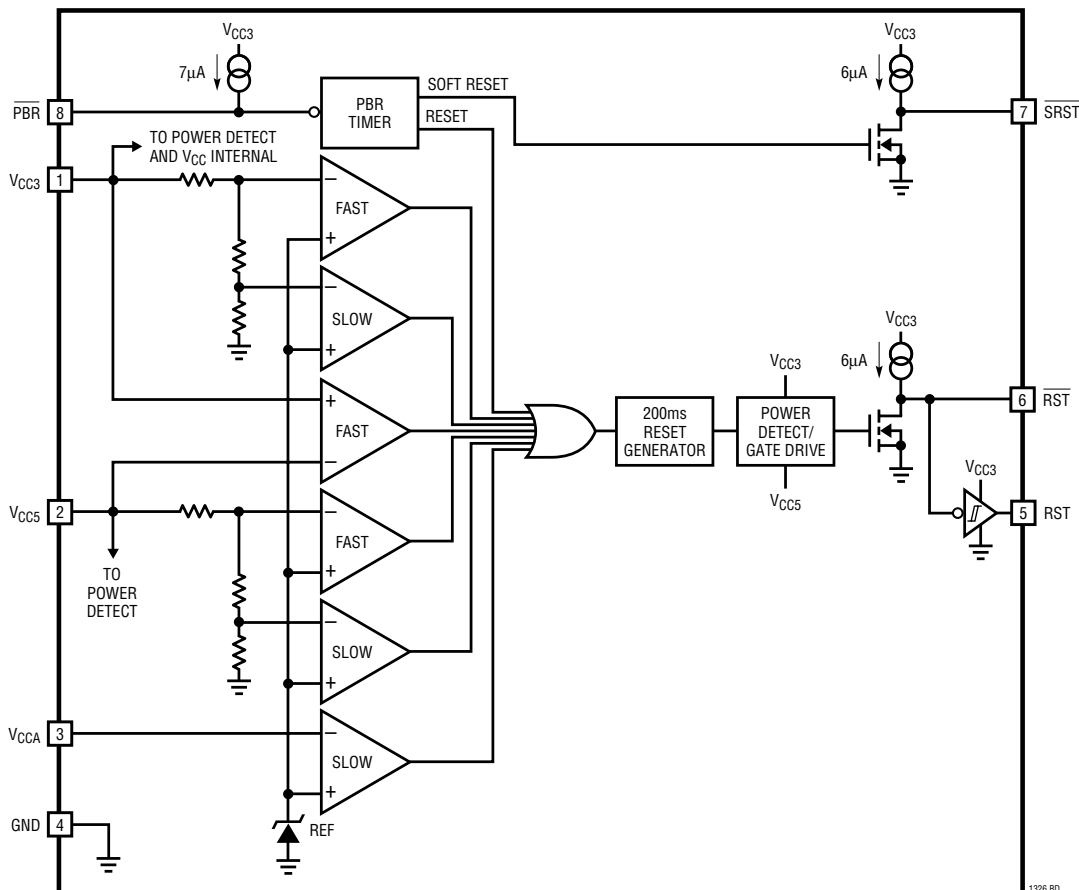

TIMING DIAGRAMS

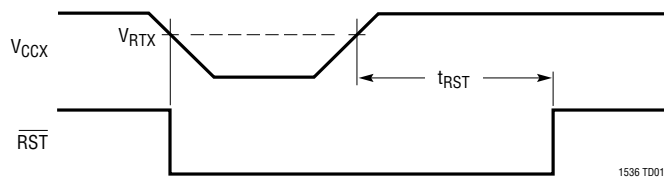
V_{CC} Monitor Timing

1536 TD01

Pushbutton Reset Function Timing

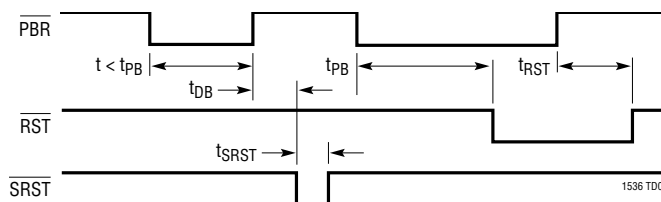

1536 TD02

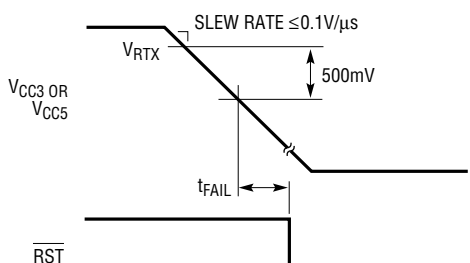
t_{FAIL} Fast Undervoltage Detect

1536 TD03

Power-Fail Detect

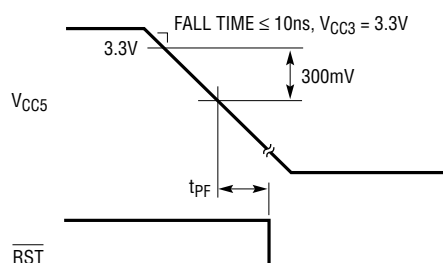

1536 TD04

APPLICATIONS INFORMATION

Operation

The LTC1536 is a low power, high accuracy triple supply monitoring circuit. This reset generator has two basic functions: generation of a reset when power supplies are out of range, and generation of a reset or “soft” reset when the reset button is pushed. The LTC1536 has the added feature that when the reset supplies are grossly undervoltage there is a very short delay from undervoltage detect to assertion of \overline{RST} .

Supply Monitoring

All three V_{CC} inputs must be above predetermined thresholds for 200ms before the reset output is released. The LTC1536 will assert reset during power-up, power-down and brownout conditions on any one or more of the V_{CC} inputs.

On power-up, either the V_{CC5} or V_{CC3} pin can power the drive circuits for the \overline{RST} pin. This ensures that \overline{RST} will

be low when either V_{CC5} or V_{CC3} reaches 1V. As long as any one of the V_{CC} inputs is below its predetermined threshold, \overline{RST} will stay a logic low. Once all of the V_{CC} inputs rise above their thresholds, an internal timer is started and \overline{RST} is released after 200ms. \overline{RST} outputs the inverted state of what is seen on \overline{RST} .

\overline{RST} is reasserted whenever any one of the V_{CC} inputs drops below its predetermined threshold and remains asserted until 200ms after all of the V_{CC} inputs are above their thresholds.

On power-down, once any of the V_{CC} inputs drops below its threshold, \overline{RST} is held at a logic low. A logic low of 0.4V is guaranteed until V_{CC3} and V_{CC5} drops below 1V.

Pushbutton Reset

The LTC1536 provides a pushbutton reset input pin. The \overline{PBR} input has an internal pull-up current source to V_{CC3} . If the \overline{PBR} pin is not used it can be left floating.

APPLICATIONS INFORMATION

When the $\overline{\text{PBR}}$ is pulled low for less than $t_{\text{PB}} (\approx 2 \text{ sec})$, a narrow ($100\mu\text{s}$ typ) soft reset pulse is generated on the $\overline{\text{SRST}}$ output pin after the button is released. The push-button circuitry contains an internal debounce counter which delays the output of the soft reset pulse by typically 20ms. This pin can be OR-tied to the $\overline{\text{RST}}$ pin and issue what is called a “soft” reset. The $\overline{\text{SRST}}$ thereby resets the microprocessor without interrupting the DRAM refresh cycle. In this manner DRAM information remains undisturbed. Alternatively, $\overline{\text{SRST}}$ may be monitored by the processor to initiate a software-controlled reset.

When the $\overline{\text{PBR}}$ pin is held low for longer than $t_{\text{PB}} (\approx 2 \text{ sec})$, a standard reset is generated. Once the 2-second period has elapsed, a reset signal is produced by the pushbutton logic, thereby clearing the reset counter. Once the $\overline{\text{PBR}}$ pin is released, the reset counter begins counting the reset period (200ms nominal). Consequently, the reset outputs remain asserted for approximately 200ms after the button is released.

Fast Undervoltage for PCI Applications

The LTC1536 is designed for PCI Local Bus applications that require reset to be asserted quickly in response to one or both of the power supply rails (5V and 3.3V) going out of spec. The spec for t_{FAIL} and t_{PF} are met with enough margin to give the designer the ability to add follow-on logic as needed by system requirements. The V_{CCA} pin can be used to monitor the “power good” signal and keep reset applied until both supplies are in spec and the power good signal is high.

Glitch Immunity and Fast Undervoltage Detection

The LTC1536 achieves its high speed characteristics while maintaining glitch immunity by using two sets of comparators. The V_{CC5} and V_{CC3} sense inputs each have two comparators set at different thresholds. A slow, very accurate comparator monitors the supply for precision undervoltage detection. In parallel, but with a threshold 250mV lower than the precision threshold, is a very fast comparator that detects when the supply is quickly going out of specification. Because the fast comparator threshold is set 250mV above the PCI specification, typical values for t_{FAIL} can be negative.

3V or 5V Power Detect/Gate Drive

The LTC1536 for the most part is powered internally from the V_{CC3} pin. The exception is at the gate drive of the output FET on the $\overline{\text{RST}}$ pin. On the gate to this FET is power detect circuitry used to detect and drive the gate from either the 3.3V pin or the 5V pin, whichever pin has the highest potential. This ensures the part pulls the $\overline{\text{RST}}$ pin low as soon as either input pin is $\geq 1\text{V}$.

Extended ESD Tolerance of the $\overline{\text{PBR}}$ Input Pin

The $\overline{\text{PBR}}$ pin is susceptible to ESD since it can be brought out to a front panel in normal applications. The ESD tolerance of this pin can be increased by adding a resistor in series with the $\overline{\text{PBR}}$ pin. A 10k resistor can increase the ESD tolerance of the $\overline{\text{PBR}}$ pin to approximately 10kV. The $\overline{\text{PBR}}$'s internal pull-up current of $7\mu\text{A}$ typical means there is only 70mV (150mV max) dropped across the resistor.

TYPICAL APPLICATIONS

PCI Expansion Board $\overline{\text{RST}}$ Generation

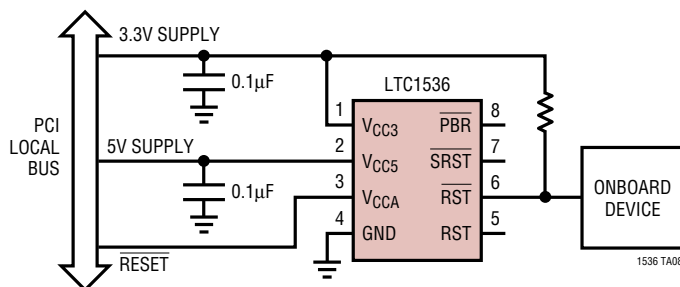

Dual Supply Monitor (3.3V and 5V, V_{CCA} Input Monitoring “Power Good”)

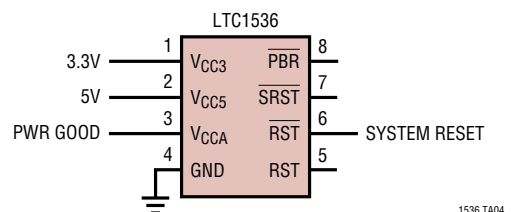

TYPICAL APPLICATIONS

Triple Supply Monitor (3.3V, 5V and Adjustable)

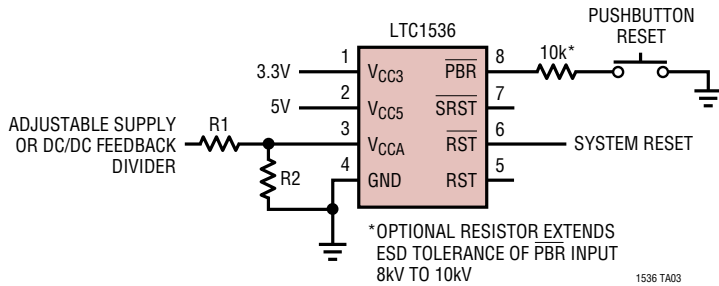

RESET Valid for V_{CC3} Down to 0V in a Dual Supply Application

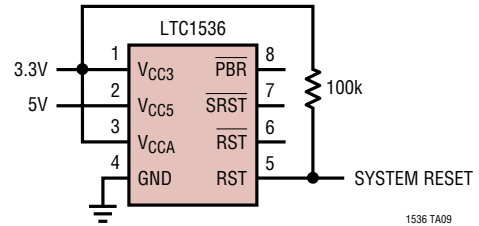

SRST Tied to RST and OR-Tying Other Sources to RST to Generate Reset and Reset

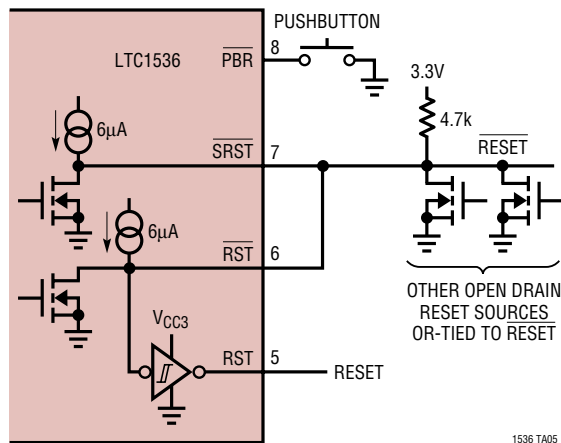

Using V_{CCA} Tied to DC/DC Feedback Divider

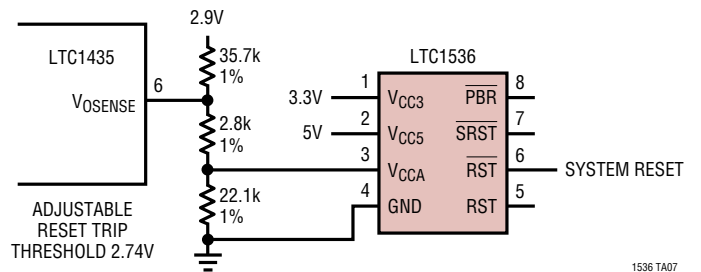

PACKAGE DESCRIPTION

MS8 Package
8-Lead Plastic MSOP
 (Reference LTC DWG # 05-08-1660)

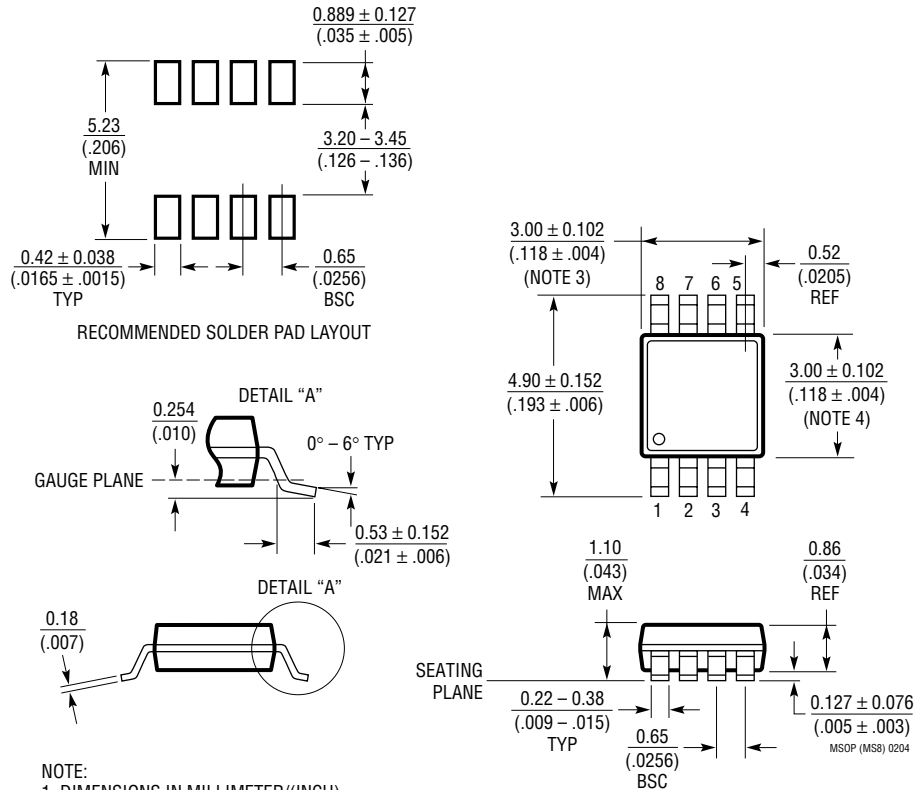

- NOTE:
1. DIMENSIONS IN MILLIMETER/(INCH)
 2. DRAWING NOT TO SCALE
 3. DIMENSION DOES NOT INCLUDE MOLD FLASH, PROTRUSIONS OR GATE BURRS. MOLD FLASH, PROTRUSIONS OR GATE BURRS SHALL NOT EXCEED 0.152mm (.006") PER SIDE
 4. DIMENSION DOES NOT INCLUDE INTERLEAD FLASH OR PROTRUSIONS. INTERLEAD FLASH OR PROTRUSIONS SHALL NOT EXCEED 0.152mm (.006") PER SIDE
 5. LEAD COPLANARITY (BOTTOM OF LEADS AFTER FORMING) SHALL BE 0.102mm (.004") MAX

PACKAGE DESCRIPTION

S8 Package 8-Lead Plastic Small Outline (Narrow .150 Inch) (Reference LTC DWG # 05-08-1610)

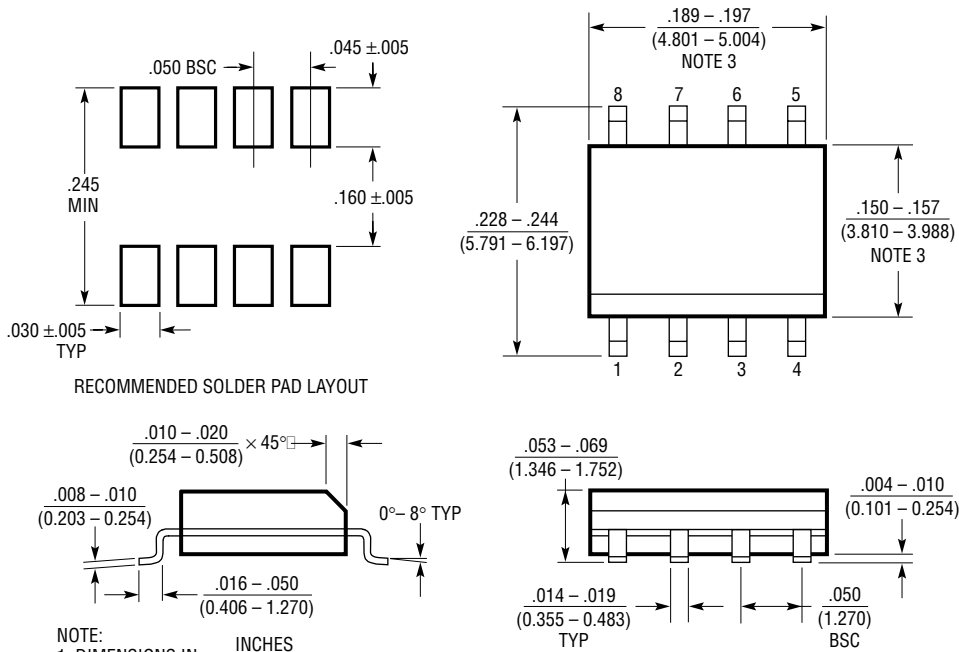

- NOTE:
 1. DIMENSIONS IN INCHES (MILLIMETERS)
 2. DRAWING NOT TO SCALE
 3. THESE DIMENSIONS DO NOT INCLUDE MOLD FLASH OR PROTRUSIONS. MOLD FLASH OR PROTRUSIONS SHALL NOT EXCEED .006" (0.15mm)

S08 0303

TYPICAL APPLICATIONS

Quad Supply Monitor:
12V: Undervoltage, Overvoltage
5V: Undervoltage, Overvoltage
3.3V: Undervoltage, Overvoltage
-12V: Undervoltage

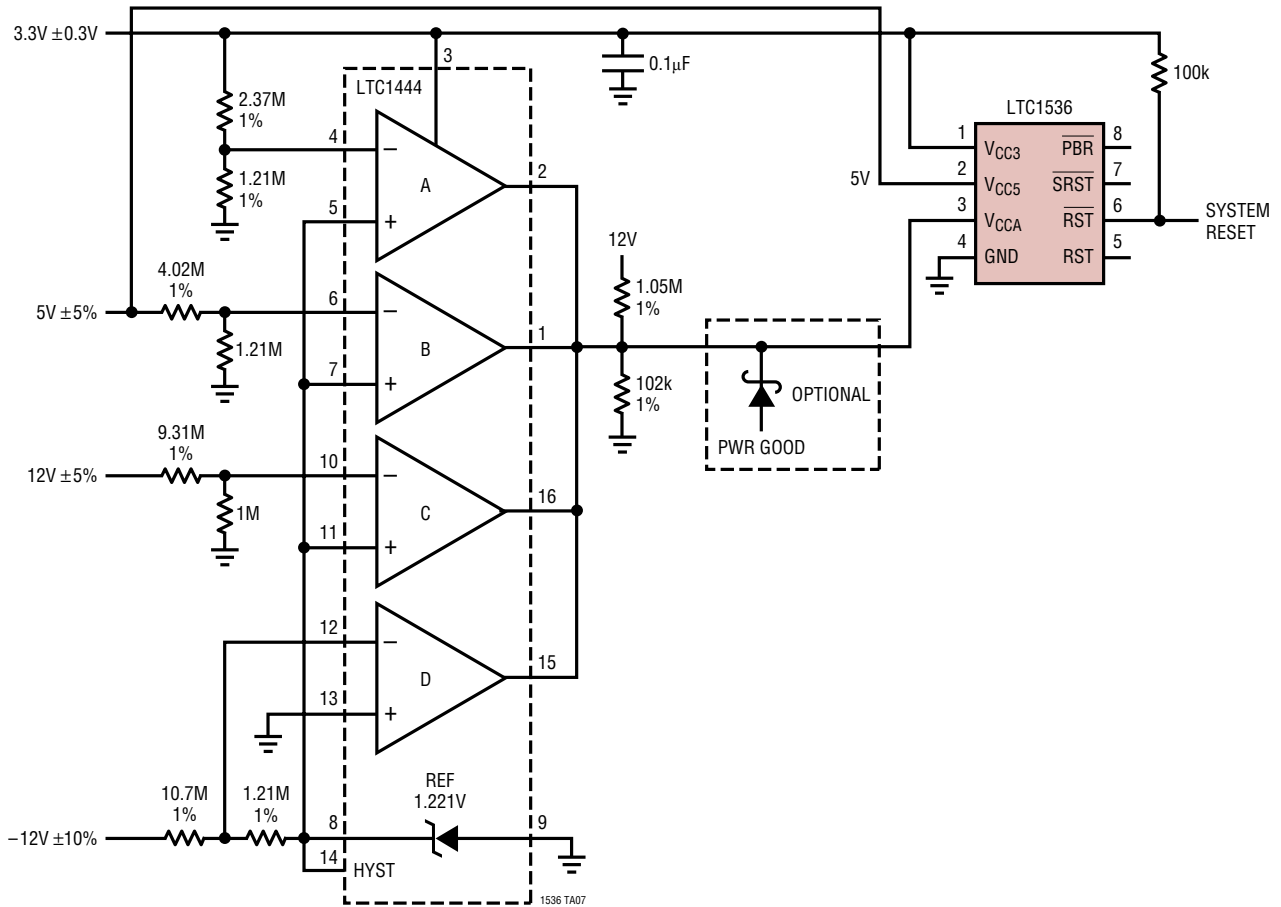

RELATED PARTS

PART NUMBER	DESCRIPTION	COMMENTS
LTC690	5V Supply Monitor, Watchdog Timer and Battery Backup	4.65V Threshold
LTC694-3.3	3.3V Supply Monitor, Watchdog Timer and Battery Backup	2.9V Threshold
LTC699	5V Supply Monitor and Watchdog Timer	4.65V Threshold
LTC1232	5V Supply Monitor, Watchdog Timer and Pushbutton Reset	4.37V/4.62V Threshold
LTC1326	Micropower Precision Triple Supply Monitor	4.725V, 3.118V, 1V Thresholds (±0.75%)
LTC1326-2.5	Micropower Precision Triple Supply Monitor	2.363V, 3.118V, 1V Thresholds (±0.75%)