

AS1907, AS1908, AS1909

Low-Voltage Microprocessor Reset Circuits

1 General Description

The AS1907/AS1908/AS1909 microprocessor supervisory circuits are ideal for monitoring the supply voltage of digital systems and microprocessors.

The devices are designed to initiate a reset if the supply voltage goes below a predefined threshold. The duration of the reset is either 1.5, 30, or 150ms (typ.) after the supply voltage has risen above the pre-set threshold (see [Ordering Information on page 9](#)).

The devices are available as the standard products listed in [Table 1](#).

Table 1. Standard Products

Model	Output Type	Reset Type
AS1907	Push/Pull	Active-Low
AS1908	Push/Pull	Active-High
AS1909	Open-Drain	Active-Low

The reset thresholds are factory-set between 1.6 and 2.5V in steps of approximately 100mV (see [Table 5 on page 7](#)).

The devices exhibit excellent reliability, and can reduce system costs by eliminating the need for external components. The extremely low current consumption makes the devices ideal for use in portable applications.

The integrated reset comparator was specifically designed to ignore fast transients on Vcc.

The devices are available in a 3-pin SOT23 package.

2 Key Features

- 3 Output Types: Push/Pull RESET, Push Pull RESETN, and Open Drain RESETN
- Reset Threshold Range: 1.6 to 2.5V (~100mV increments)
- RESET/RESETN:
 - Valid to Vcc = 0.7V (AS1907 and AS1908)
 - Valid to Vcc = 1.0V (AS1909)
- Reset Pulse Widths: 1, 20, and 100ms
- Supply Voltage Range: +0.7 to +3.6V
- Supply Current Range: 2.6 to 7.0µA
- Power Supply Transient Immunity
- Requires No External Components
- Operating Temperature Range: -40 to +125°C
- 3-pin SOT23 Package

3 Applications

The devices are ideal for use in cordless and mobile phones, MP3 players, CD and DVD players, PDAs, handheld computers, digital cameras, hard drives, and any other application where power supply supervisory control is required.

Figure 1. Application Diagrams

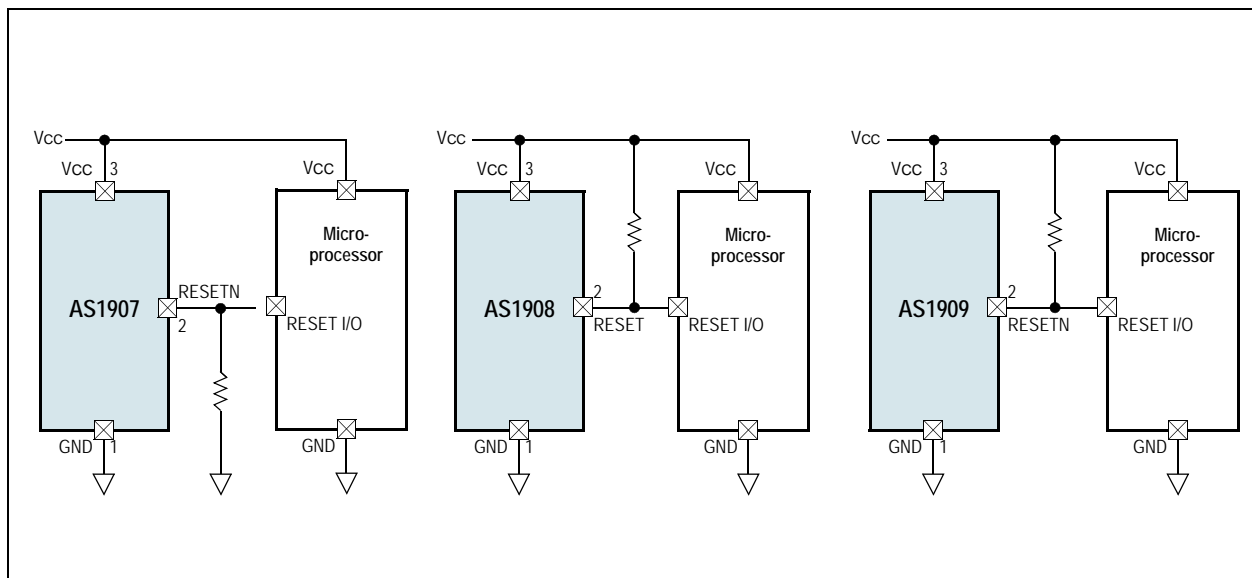



4 Pin Assignments

Figure 2. Pin Assignments (Top View)

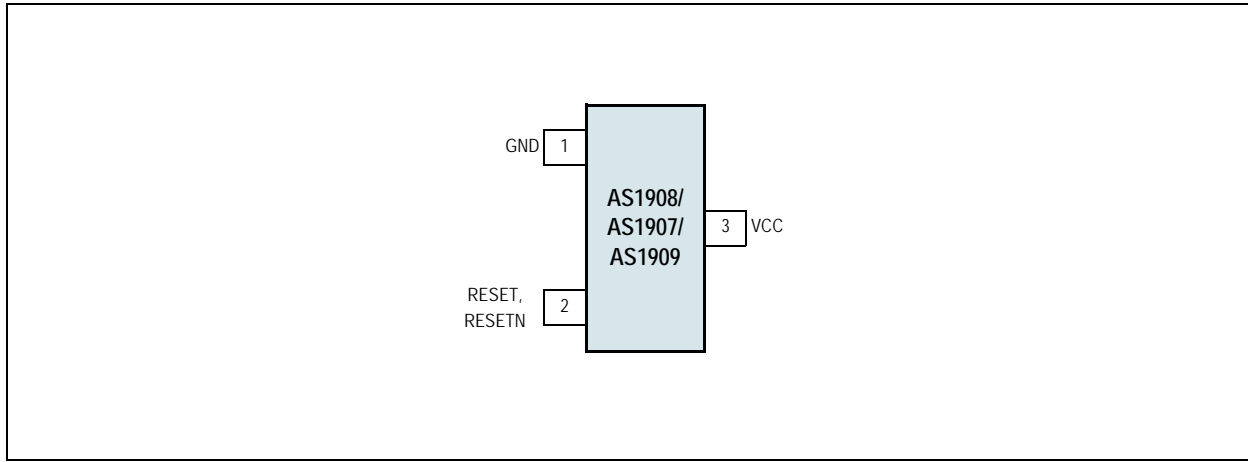

4.1 Pin Descriptions

Table 2. Pin Descriptions

Pin Number	Pin Name	Description
1	GND	Ground
2	RESET	Active-High Reset Output (AS1908). This pin stays high whenever VCC is below the RESET threshold V_{TH} (see page 7), and for t_{TP} (see page 4) after VCC rises above V_{TH} .
	RESETN	Active-Low Reset Output (AS1907, AS1909). This pin remains low while VCC is below the RESET threshold V_{TH} (see page 7), and for t_{TP} (see page 4) after VCC rises above V_{TH} . Note: This pin is open-drain on the AS1909.
3	VCC	Positive Supply Voltage. Connect to +0.7 to +3.6V supply.



5 Absolute Maximum Ratings

Stresses beyond those listed in [Table 3](#) may cause permanent damage to the device. These are stress ratings only, and functional operation of the device at these or any other conditions beyond those indicated in [Electrical Characteristics on page 4](#) is not implied. Exposure to absolute maximum rating conditions for extended periods may affect device reliability.

Table 3. Absolute Maximum Ratings

Parameter	Min	Max	Units	Comments
Electrical Parameters				
Vcc to GND	-0.3	+5.0	V	
Open-Drain RESETN	-0.3	+6.0	V	
Push/Pull RESET, RESETN	-0.3	V _{CC} + 0.3	V	
Input Current (Vcc)		20	mA	
Output Current (RESET, RESETN)		20	mA	
Electrostatic Discharge				
Electrostatic Discharge HBM		±1	kV	Norm: MIL 883 E Method 3015
Continuous Power Dissipation				
Continuous Power Dissipation (T _{AMB} = +70°C)		320	mW	3-pin SOT23 derate 4mW/°C above +70°C
Temperature Ranges and Storage Conditions				
Junction Temperature		+150	°C	
Storage Temperature Range	-55	+150	°C	
Package Body Temperature		+260	°C	The reflow peak soldering temperature (body temperature) specified is in accordance with <i>IPC/JEDEC J-STD-020 "Moisture/Reflow Sensitivity Classification for Non-Hermetic Solid State Surface Mount Devices"</i> . The lead finish for Pb-free leaded packages is matte tin (100% Sn).
Humidity non-condensing	8	85	%	
Moisture Sensitive Level		1		Represents a maximum floor life time of unlimited



6 Electrical Characteristics

V_{CC} = Full Range, T_{AMB} = -40 to +125°C (unless otherwise specified). Typ values are at V_{CC} = +3.0V, T_{AMB} = +25°C. All limits are guaranteed. The parameters with min and max values are guaranteed with production tests or SQC (Statistical Quality Control) methods.

Table 4. Electrical Characteristics

Symbol	Parameter	Conditions	Min	Typ	Max	Unit	
V _{CC}	Supply Voltage Range	T _{AMB} = 0 to +85°C	AS1907, AS1908	0.7		3.6	V
			AS1909	1.0		3.6	
		T _{AMB} = -40 to +85°C	AS1907, AS1908	0.78		3.6	
			AS1909	1.2		3.6	
T _{AMB} = -40 to +125°C			1.2		3.6		
I _{CC}	Supply Current ¹	V _{CC} = 1.8V, no load			2.4	6.0	μA
		V _{CC} = 2.5V, no load			2.6	7.0	
		T _{AMB} = +25°C		V _{TH} - 0.9%	V _{TH}	V _{TH} + 0.9%	V
V _{TH}	RESET Threshold Voltage	T _{AMB} = 0°C to +50°C; AS1909C17, AS1909C168, AS1909C188 only		V _{TH} - 1.2%	V _{TH}	V _{TH} + 1.2%	V
		T _{AMB} = -40 to +125°C		V _{TH} - 3%	V _{TH}	V _{TH} + 3%	V
t _{RD}	V _{CC} Falling Reset Delay	V _{CC} falling at 10V/ms			33		μs
t _{TP}	RESET Active Time-Out Period	AS190x-Azz-T		1	1.5	2	ms
		AS190x-Bzz-T		20	30	40	
		AS190x-Czz-T		100	150	200	
V _{OL}	RESETN Output Low Voltage; RESET asserted (AS1907/AS1909)	I _{SINK} = 50μA, V _{CC} ≥ 1.0V				0.4	V
		I _{SINK} = 500μA, V _{CC} ≥ 1.8V				0.3	
V _{OH}	RESETN Output High Voltage; RESET Not Asserted (AS1907)	I _{SOURCE} = 200μA, V _{CC} ≥ 1.8V		0.8 x V _{CC}			V
		I _{SOURCE} = 500μA, V _{CC} ≥ 2.7V		0.8 x V _{CC}			
V _{OH}	RESET Output Voltage; RESET Asserted (AS1908)	I _{SOURCE} = 1μA, V _{CC} ≥ 1.0V		0.8 x V _{CC}			V
		I _{SOURCE} = 200μA, V _{CC} ≥ 1.8V		0.8 x V _{CC}			
V _{OL}	RESET Output Voltage; RESET Not Asserted (AS1908)	I _{SINK} = 500μA, V _{CC} ≥ 1.8V				0.3	V
		I _{SINK} = 1.2mA, V _{CC} ≥ 2.7V				0.3	
I _{LEAK}	RESETN Output Leakage Current; RESETN Deasserted (AS1909)	V _{CC} > V _{TH}				0.5	μA

1. Not valid if V_{CC} = V_{TH}.



7 Typical Operating Characteristics

$T_{AMB} = +25^{\circ}\text{C}$ (unless otherwise specified).

Figure 3. Supply Current vs. Temperature

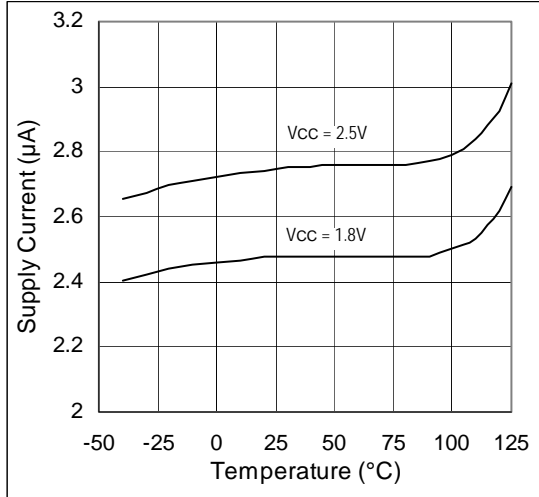

Figure 4. Supply Current vs. Supply Voltage

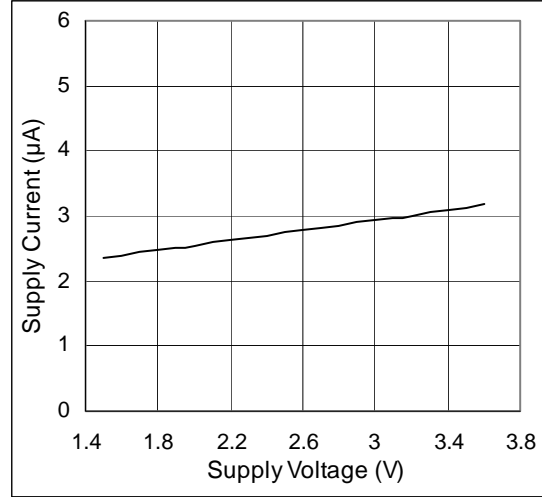

Figure 5. Normalized Reset Timeout Period vs. Temperature, $V_{TH} = 2.3V_{Reset\ Asserted}$

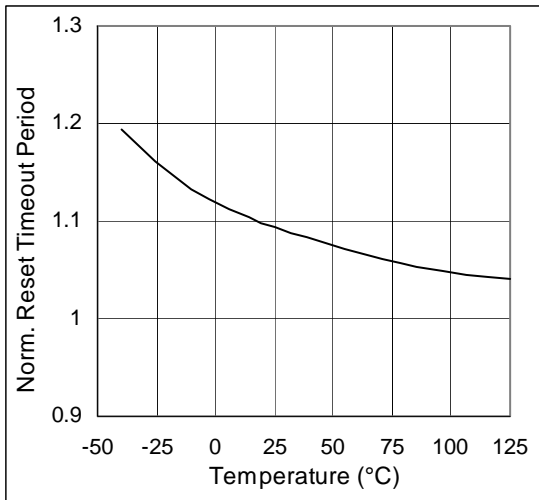

Figure 6. Output Voltage Low vs. Temperature

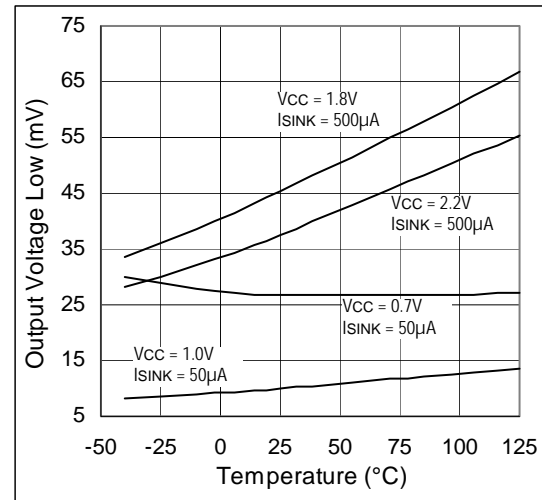



Figure 7. Max. Transient Duration vs. Reset Comparator Overdrive Temperature

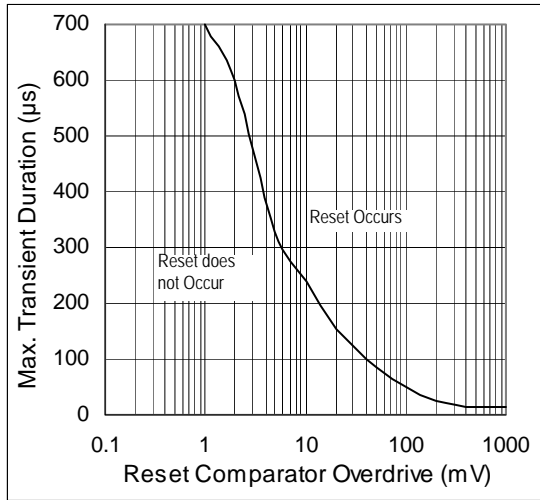

Figure 8. Vcc falling Propagation Delay vs.

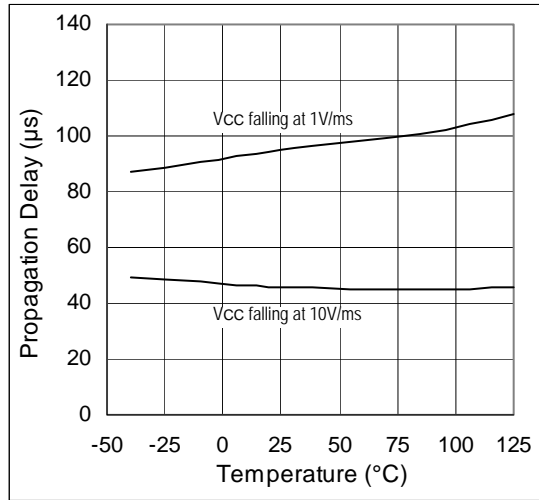

Figure 9. Output Voltage Low vs. VCC, ISINK = 50μA

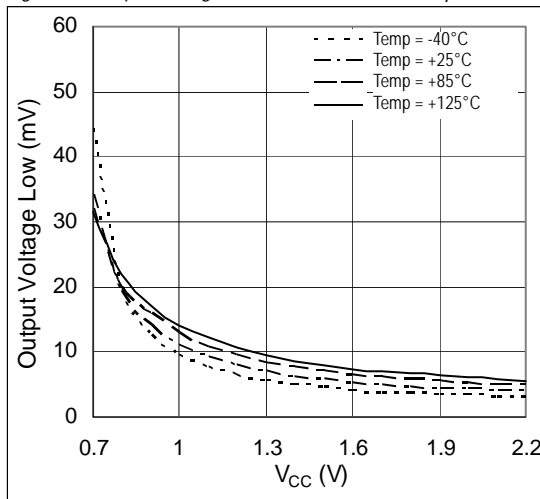

Figure 10. Output Voltage Low vs. VCC, ISINK = 100μA

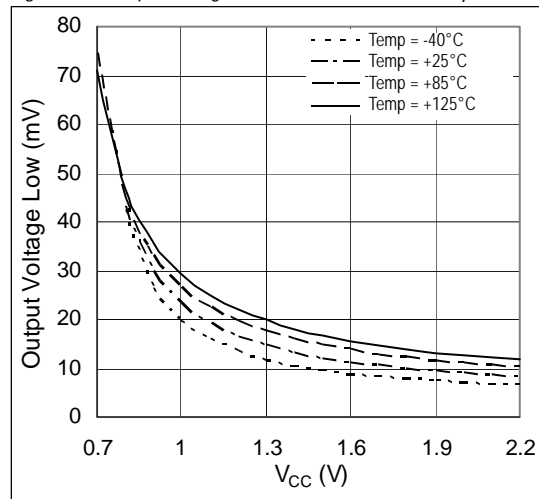
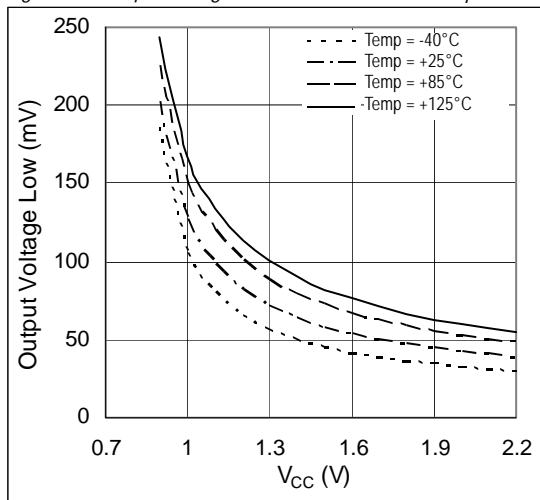

Figure 11. Output Voltage Low vs. VCC, ISINK = 500μA





8 Application Information

8.1 Negative Going V_{CC} Transients

All devices are effectively immune to short-duration, negative-going V_{CC} transients (glitches). The Maximum Transient Duration vs. Reset Comparator Overdrive graph (see page 5) shows the maximum pulse width that a negative-going V_{CC} transient may typically have without issuing a reset signal. As the amplitude of the transient increases, the maximum allowable pulse width decreases.

8.2 Valid Reset Output

If V_{CC} falls below 1V and approaches the minimum operating voltage of 0.7V, push/pull-type reset sinking/sourcing capabilities greatly decrease. High-impedance CMOS-logic inputs connected to RESET can drift to indeterminate voltages, although this is normally not a problem since most microprocessors do not operate at V_{CC} < 1V.

For the AS1908, where RESET must be valid to V_{CC} = 0, a 100k Ω pull-up resistor between RESET and V_{CC} (see Figure 1 on page 1) will hold RESET high if V_{CC} falls below 0.7V.

For the AS1907, where RESET must be valid down to 0V, add a pull-down resistor between RESET and GND (see Figure 1 on page 1) to eliminate stray leakage currents and hold RESET low. A pull-down resistor of 100k Ω is large enough not to load RESET yet small enough to pull it low.

Since the AS1909 has an open-drain, active-low output, it typically uses a pull-up resistor. With this device, RESET will most likely not maintain an active condition, but will drift to a non-active level due to the pull-up resistor and the reduced sinking capability of the open drain device. Therefore, this device is not recommended for applications where the RESET pin is required to be valid down to V_{CC} = 0.

Table 5. Reset Thresholds

Reset Thresholds					
Suffix	T _{AMB} = +25°C			T _{AMB} = -40 to +125°C	
	Min	Typ	Max	Min	Max
25	2.478	2.50	2.523	2.43	2.58
24	2.378	2.40	2.422	2.33	2.47
23	2.279	2.30	2.321	2.23	2.37
22	2.180	2.20	2.220	2.13	2.27
21	2.081	2.10	2.119	2.04	2.18
20	1.982	2.00	2.018	1.94	2.06
19	1.883	1.90	1.917	1.84	1.96
18	1.784	1.80	1.816	1.75	1.85
17	1.685	1.70	1.715	1.65	1.75
16	1.586	1.60	1.614	1.55	1.65

8.3 Bi-Directional Microprocessor Interface

The RESET output on the AS1909 is open-drain, thus this device can interface easily with microprocessors that have bi-directional reset pins, such as the Motorola 68HC11.

Connect the RESET output of this device directly to the microprocessor's RESET I/O pin with a single pull-up resistor to allow either device to assert reset (see Figure 1 on page 1).

8.4 Layout Considerations

The devices require proper layout and design procedures for optimum performance.

- Short, wide traces should be used to reduce stray inductance and capacitance.
- Bypass capacitors should be as close to the device as possible.
- Large ground planes should be used wherever possible.



9 Package Drawings and Markings

Figure 12. 3-pin SOT23 Package

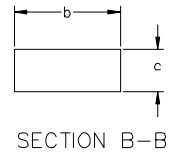
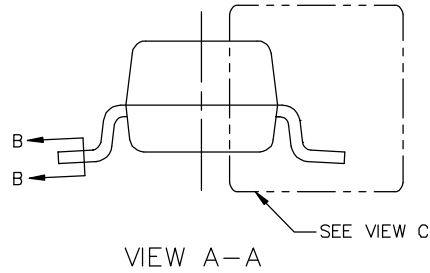
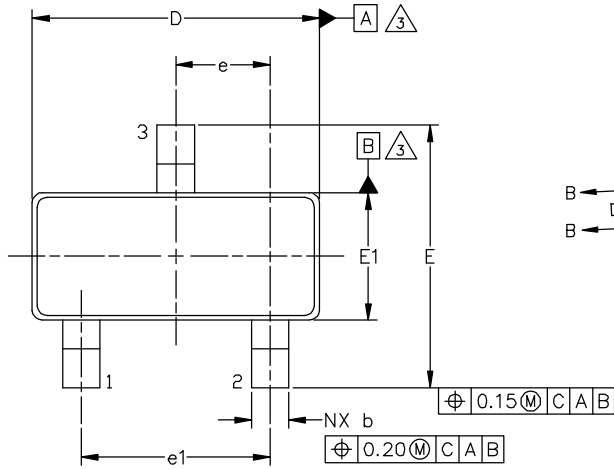

REF.	MIN	NOM	MAX
A	0.89	—	1.12
A1	0.01	—	0.10
A2	0.88	0.95	1.02
b	0.30	—	0.50
c	0.08	—	0.20
D	2.80	2.90	3.04
E	2.10	—	2.64
E1	1.20	1.30	1.40
e	0.95 BSC		
e1	1.90 BSC		
L	0.40	0.50	0.60
L1	0.54 REF		
L2	0.25 BSC		
\varnothing	0°	—	8°
N	3		

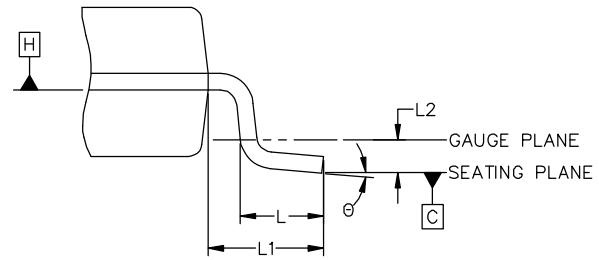
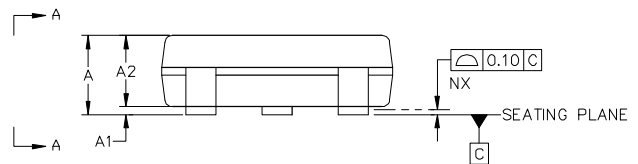

VIEW C

NOTE:

1. DIMENSIONS & TOLERANCEING CONFIRM TO ASME Y14.5M-1994.
 2. ALL DIMENSIONS ARE IN MILLIMETERS. ANGELS ARE IN DEGREES.
- \triangle DATUMS A AND B TO BE DETERMINED AT DATUM PLANE H.



Top Marking

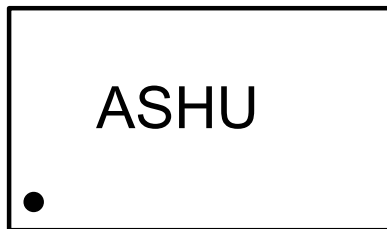

Bottom Marking

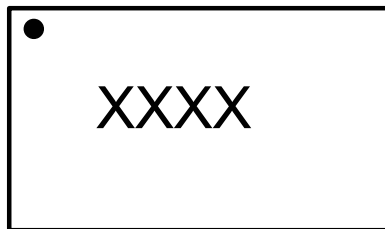

xxxx- encoded Datacode



10 Ordering Information

The devices are available as the standard products shown in [Table 6](#).

Table 6. Ordering Information

Ordering Code	Marking	Reset Type	Reset Threshold	Minimum Reset Timeout	Delivery Form
AS1908C18-T	ASHU	Active High	1.8V	100ms	Tape and Reel
AS1908C20-T	ASHV	Active High	2.0V	100ms	Tape and Reel
AS1907C16-T	ASHP	Active Low	1.6V	100ms	Tape and Reel
AS1907C18-T	ASHQ	Active Low	1.8V	100ms	Tape and Reel
AS1907C20-T	ASHR	Active Low	2.0V	100ms	Tape and Reel
AS1907C22-T	ASNB	Active Low	2.2V	100ms	Tape and Reel
AS1907B23-T	ASHX	Active Low	2.3V	20ms	Tape and Reel
AS1909C16-T	ASHY	Open Drain	1.6V	100ms	Tape and Reel
AS1909C168-T	ASSB	Open Drain	1.68V	100ms	Tape and Reel
AS1909C17-T	ASHZ	Open Drain	1.7V	100ms	Tape and Reel
AS1909C18-T	ASND	Open Drain	1.8V	100ms	Tape and Reel
AS1909C188-T	ASTE	Open Drain	1.88V	100ms	Tape and Reel
AS1909C20-T	ASH1	Open Drain	2.0V	100ms	Tape and Reel
AS1909C22-T	ASNC	Open Drain	2.2V	100ms	Tape and Reel
AS1909C23-T	ASH2	Open Drain	2.3V	100ms	Tape and Reel

Non-standard versions require a minimum order of 30,000 units. Contact ams AG for availability of non-standard versions.

Table 7. Coding of Factory-Trimmed Reset Active Time-Out Period

Device	Suffix	tTP in Milliseconds		
		Min	Typ	Max
AS1907xyy-T*	A	1	1.5	2
AS1908xyy-T*	B	20	30	40
AS1909xyy-T*	C	100	150	200

* These devices are available in factory-set V_{CC} reset thresholds from 1.6V to 2.5V, in approximately 100mV increments. Choose the desired reset threshold suffix from ([see Table 5 on page 7](#)) and insert it instead of "yy" in the part number.

Factory-programmed reset timeout periods are also available. Insert the code corresponding to the desired nominal reset timeout period ([see Table 7](#)) instead of "x" in the part number. All devices available in tape-and-reel only.

Note: All products are RoHS compliant and ams green.
Buy our products or get free samples online at www.ams.com/ICdirect

Technical Support is available at www.ams.com/Technical-Support

For further information and requests, email us at sales@ams.com
(or) find your local distributor at www.ams.com/distributor



Copyrights

Copyright © 1997-2013, ams AG, Tobelbaderstrasse 30, 8141 Unterpremstaetten, Austria-Europe. Trademarks Registered ®. All rights reserved. The material herein may not be reproduced, adapted, merged, translated, stored, or used without the prior written consent of the copyright owner.

All products and companies mentioned are trademarks or registered trademarks of their respective companies.

Disclaimer

Devices sold by ams AG are covered by the warranty and patent indemnification provisions appearing in its Term of Sale. ams AG makes no warranty, express, statutory, implied, or by description regarding the information set forth herein or regarding the freedom of the described devices from patent infringement. ams AG reserves the right to change specifications and prices at any time and without notice. Therefore, prior to designing this product into a system, it is necessary to check with ams AG for current information. This product is intended for use in normal commercial applications. Applications requiring extended temperature range, unusual environmental requirements, or high reliability applications, such as military, medical life-support or life-sustaining equipment are specifically not recommended without additional processing by ams AG for each application. For shipments of less than 100 parts the manufacturing flow might show deviations from the standard production flow, such as test flow or test location.

The information furnished here by ams AG is believed to be correct and accurate. However, ams AG shall not be liable to recipient or any third party for any damages, including but not limited to personal injury, property damage, loss of profits, loss of use, interruption of business or indirect, special, incidental or consequential damages, of any kind, in connection with or arising out of the furnishing, performance or use of the technical data herein. No obligation or liability to recipient or any third party shall arise or flow out of ams AG rendering of technical or other services.



Contact Information

Headquarters

ams AG
Tobelbaderstrasse 30
A-8141 Unterpremstaetten, Austria

Tel : +43 (0) 3136 500 0
Fax : +43 (0) 3136 525 01

For Sales Offices, Distributors and Representatives, please visit:

<http://www.ams.com/contact>