

# MC33460, MC33461

## Under Voltage Detector Series

The MC33460 and MC33461 series are ultra-low power CMOS under-voltage detectors with very tight threshold accuracy specifically designed for accurate monitoring of power supplies. The devices are optimized for use in battery powered systems where low quiescent current and small packaging are required. The device generates an active-low signal whenever the input voltage falls below the factory set  $\pm 2\%$  threshold. Hysteresis is provided to ensure reliable output switching.

The MC33460/1 series features a highly accurate voltage reference, a comparator with a precision voltage threshold, and built-in hysteresis to prevent erratic operation and a choice of output configurations between Open Drain (MC33460) and complementary push-pull (MC33461). The products are offered in 9 standard voltage thresholds ranging from 0.9V to 4.5V. Other threshold voltages from 1.0 to 5.0V are available in 100mV steps. The devices can operate to a very low input voltage level and are housed in the ultra-miniature SC-82AB package.

### Features

- Available in Open Drain or Push-Pull Output
- Output State Guaranteed to  $V_{in} = 0.8\text{ V}$
- Tight Detector Voltage Accuracy ( $\pm 2.0\%$ )
- Extended Temperature Operation ( $-40^{\circ}\text{C}$  to  $85^{\circ}\text{C}$ )
- Ultra Low Quiescent Current ( $0.8\ \mu\text{A}$  at  $V_{in} = 1.5\text{ V}$  typical)
- Wide Range of Operating Voltage ( $0.7\text{ V}$  to  $10\text{ V}$ )

### Applications

- Low Battery Detector
- Power-Fail Indicator
- Microprocessor Reset Generator
- Window Comparator
- Battery Backup Circuit

### Representative Block Diagrams

MC33460  
Nch Open Drain Configuration

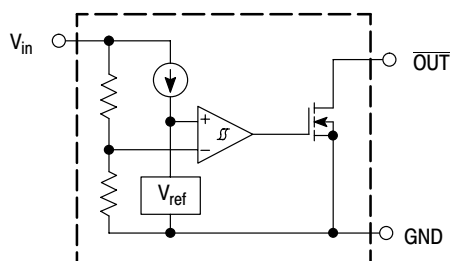

MC33461  
CMOS Configuration

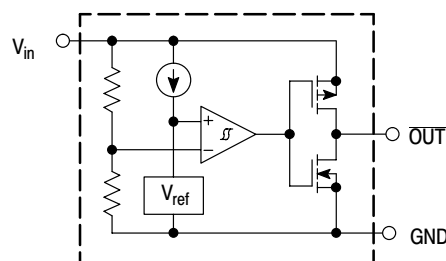

ON Semiconductor®

<http://onsemi.com>

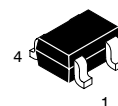

SC-82AB  
SQ SUFFIX  
CASE 419C

### PIN CONNECTIONS

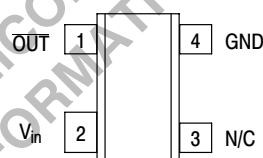

(Top View)

### ORDERING INFORMATION

See detailed ordering and shipping information in the package dimensions section on page 2 of this data sheet.

# MC33460, MC33461

## ORDERING INFORMATION

Device	Threshold Voltage	Type	Marking	Package (Qty/Reel)
MC33460SQ-09ATR	0.9	Nch Open Drain	K9	3000 Units on 7 inch Reel
MC33460SQ-20ATR	2.0		M0	
MC33460SQ-27ATR	2.7		M7	
MC33460SQ-28ATR	2.8		M8	
MC33460SQ-30ATR	3.0		N0	
MC33460SQ-32ATR	3.2		N2	
MC33460SQ-41ATR	4.1		P1	
MC33460SQ-42ATR	4.2		P2	
MC33460SQ-43ATR	4.3		P3	
MC33460SQ-45ATR	4.5		P5	
MC33461SQ-09CTR	0.9	CMOS	T9	
MC33461SQ-20CTR	2.0		V0	
MC33461SQ-27CTR	2.7		V7	
MC33461SQ-28CTR	2.8		V8	
MC33461SQ-30CTR	3.0		W0	
MC33461SQ-32CTR	3.2		W2	
MC33461SQ-41CTR	4.1		X1	
MC33461SQ-42CTR	4.2		X2	
MC33461SQ-43CTR	4.3		X3	
MC33461SQ-45CTR	4.5		X5	

## MAXIMUM RATINGS

Rating	Symbol	Value	Unit
Supply Voltage	$V_{in}$	12	V
Output Voltage (CMOS)	$V_{OUT1}$	-0.3 to $V_{in}+0.3$	V
Output Voltage (Nch Open Drain)	$V_{OUT2}$	-0.3 to 12	V
Output Current	$I_{OUT}$	70	mA
Power Dissipation	$P_D$	150	mW
Operating Ambient Temperature	$T_A$	-40 to +85	°C
Storage Temperature Range	$T_{stg}$	-40 to +125	°C
Lead Temperature (Soldering)	$T_{solder}$	260°C, 10 s	-

# MC33460, MC33461

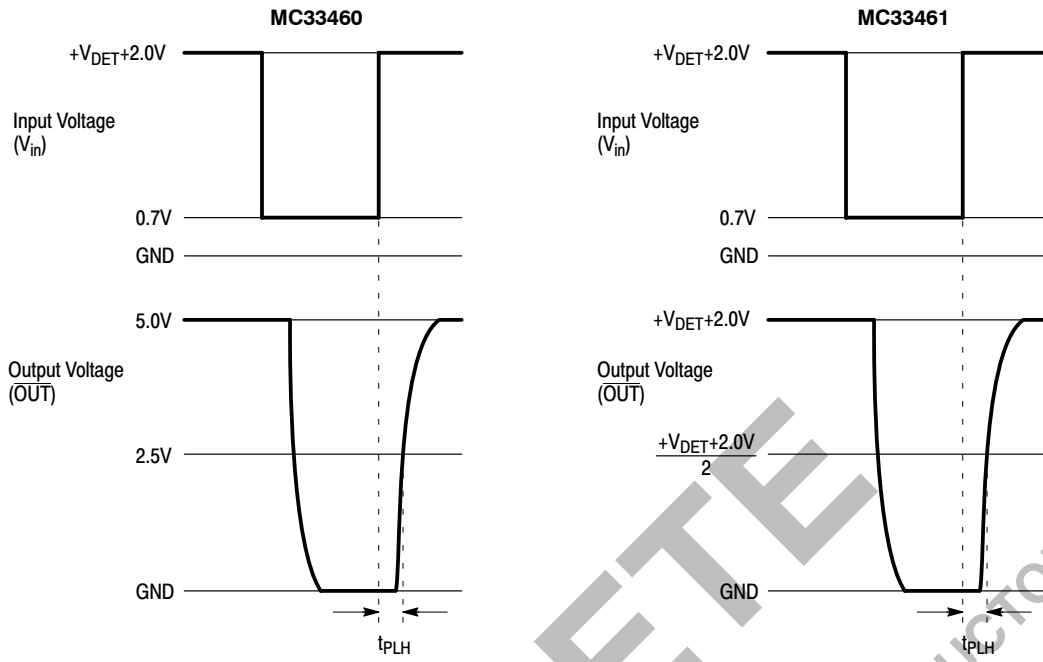

Note: Measured with 470k pullup resistor from  $\overline{OUT}$  to +5V.

Figure 1.  $T_{pd}$  Measurement Conditions

**OBSOLETE**  
THIS DEVICE IS OBSOLETE  
PLEASE CONTACT YOUR ON SEMICONDUCTOR  
REPRESENTATIVE FOR INFORMATION

# MC33460, MC33461

## ELECTRICAL CHARACTERISTICS (For all values $T_A = 25^\circ\text{C}$ , unless otherwise noted.)

Characteristic	Symbol	Min	Typ	Max	Unit
<b>MC33460/461 - 0.9</b>					
Detector Threshold ( $V_{in}$ Falling)	$V_{DET-}$	0.882	0.900	0.918	V
Detector Threshold Hysteresis	$V_{HYS}$	0.027	0.045	0.063	V
Supply Current	$I_{in}$	-	0.8	2.4	$\mu\text{A}$
		-	1.0	3.0	
Maximum Operating Voltage	$V_{in(max)}$	-	-	10	V
Minimum Operating Voltage	$V_{in(min)}$	-	0.55	0.70	V
		-	0.65	0.80	
Output Current ( $\overline{\text{OUT}}$ )	$I_{OUT}$				
Nch		0.01	0.05	-	mA
		0.05	0.50	-	mA
CMOS Output High		1.0	2.0	-	mA
Output Delay Time (Note 1)	$t_{pd}$	-	-	100	$\mu\text{s}$
Detector Threshold Temperature Coefficient	$\Delta V_{DET-}/\Delta T$	-	$\pm 100$	-	PPM/ $^\circ\text{C}$

NOTES: 1. Refer to Figure 1 for test conditions for measurement.

## ELECTRICAL CHARACTERISTICS (For all values $T_A = 25^\circ\text{C}$ , unless otherwise noted.)

Characteristic	Symbol	Min	Typ	Max	Unit
<b>MC33460/461 - 2.0</b>					
Detector Threshold ( $V_{in}$ Falling)	$V_{DET-}$	1.96	2.00	2.04	V
Detector Threshold Hysteresis	$V_{HYS}$	0.06	0.10	0.14	V
Supply Current	$I_{in}$	-	0.9	2.7	$\mu\text{A}$
		-	1.1	3.3	
Maximum Operating Voltage	$V_{in(max)}$	-	-	10	V
Minimum Operating Voltage	$V_{in(min)}$	-	0.55	0.70	V
		-	0.65	0.80	
Output Current ( $\overline{\text{OUT}}$ )	$I_{OUT}$				
Nch		0.01	0.05	-	mA
		1.0	2.0	-	mA
CMOS Output High		1.0	2.0	-	mA
Output Delay Time (Note 1)	$t_{pd}$	-	-	100	$\mu\text{s}$
Detector Threshold Temperature Coefficient	$\Delta V_{DET-}/\Delta T$	-	$\pm 100$	-	PPM/ $^\circ\text{C}$

NOTES: 1. Refer to Figure 1 for test conditions for measurement.

# MC33460, MC33461

## ELECTRICAL CHARACTERISTICS (For all values $T_A = 25^\circ\text{C}$ , unless otherwise noted.)

Characteristic	Symbol	Min	Typ	Max	Unit	
<b>MC33460/461 - 2.7</b>						
Detector Threshold ( $V_{in}$ Falling)	$V_{DET-}$	2.646	2.700	2.754	V	
Detector Threshold Hysteresis	$V_{HYS}$	0.081	0.135	0.189	V	
Supply Current	$I_{in}$	$(V_{in} = 2.6\text{ V})$	0.9	2.7	$\mu\text{A}$	
		$(V_{in} = 4.7\text{ V})$	-	1.1	3.3	
Maximum Operating Voltage	$V_{in(max)}$	-	-	10	V	
Minimum Operating Voltage	$V_{in(min)}$	$(-40^\circ\text{C} \leq T_A \leq 85^\circ\text{C})$	0.55	0.70	V	
			-	0.65	0.80	
Output Current ( $\overline{\text{OUT}}$ )	$I_{OUT}$	$(V_{out} = 0.05\text{V}, V_{in} = 0.70\text{V})$ $(V_{out} = 0.50\text{V}, V_{in} = 1.5\text{V})$ $(V_{out} = 2.4\text{V}, V_{in} = 4.5\text{V})$	0.01	0.05	-	mA
Nch			1.0	2.0	-	mA
CMOS Output High			1.0	2.0	-	mA
Output Delay Time (Note 1)	$t_{pd}$	-	-	100	$\mu\text{s}$	
Detector Threshold Temperature Coefficient	$\Delta V_{DET-}/\Delta T$	-	$\pm 100$	-	PPM/ $^\circ\text{C}$	

NOTES: 1. Refer to Figure 1 for test conditions for measurement.

## ELECTRICAL CHARACTERISTICS (For all values $T_A = 25^\circ\text{C}$ , unless otherwise noted.)

Characteristic	Symbol	Min	Typ	Max	Unit	
<b>MC33460/461 - 2.8</b>						
Detector Threshold ( $V_{in}$ Falling)	$V_{DET-}$	2.744	2.800	2.856	V	
Detector Threshold Hysteresis	$V_{HYS}$	0.084	0.140	0.196	V	
Supply Current	$I_{in}$	$(V_{in} = 2.7\text{ V})$	0.9	2.7	$\mu\text{A}$	
		$(V_{in} = 4.8\text{ V})$	-	1.1	3.3	
Maximum Operating Voltage	$V_{in(max)}$	-	-	10	V	
Minimum Operating Voltage	$V_{in(min)}$	$(-40^\circ\text{C} \leq T_A \leq 85^\circ\text{C})$	0.55	0.70	V	
			-	0.65	0.80	
Output Current ( $\overline{\text{OUT}}$ )	$I_{OUT}$	$(V_{out} = 0.05\text{V}, V_{in} = 0.70\text{V})$ $(V_{out} = 0.50\text{V}, V_{in} = 1.5\text{V})$ $(V_{out} = 2.4\text{V}, V_{in} = 4.5\text{V})$	0.01	0.05	-	mA
Nch			1.0	2.0	-	mA
CMOS Output High			1.0	2.0	-	mA
Output Delay Time (Note 1)	$t_{pd}$	-	-	100	$\mu\text{s}$	
Detector Threshold Temperature Coefficient	$\Delta V_{DET-}/\Delta T$	-	$\pm 100$	-	PPM/ $^\circ\text{C}$	

NOTES: 1. Refer to Figure 1 for test conditions for measurement.

# MC33460, MC33461

## ELECTRICAL CHARACTERISTICS (For all values $T_A = 25^\circ\text{C}$ , unless otherwise noted.)

Characteristic	Symbol	Min	Typ	Max	Unit		
<b>MC33460/461 - 3.0</b>							
Detector Threshold ( $V_{in}$ Falling)	$V_{DET-}$	2.94	3.00	3.06	V		
Detector Threshold Hysteresis	$V_{HYS}$	0.09	0.15	0.21	V		
Supply Current ( $V_{in} = 2.87\text{ V}$ ) ( $V_{in} = 5.0\text{ V}$ )	$I_{in}$	- -	1.0 1.2	3.0 3.6	$\mu\text{A}$		
Maximum Operating Voltage	$V_{in(max)}$	-	-	10	V		
Minimum Operating Voltage ( $-40^\circ\text{C} \leq T_A \leq 85^\circ\text{C}$ )	$V_{in(min)}$	- -	0.55 0.65	0.70 0.80	V		
Output Current ( $\overline{\text{OUT}}$ ) Nch CMOS Output High	$I_{OUT}$		( $V_{out} = 0.05\text{V}, V_{in} = 0.70\text{V}$ ) ( $V_{out} = 0.50\text{V}, V_{in} = 1.5\text{V}$ ) ( $V_{out} = 2.4\text{V}, V_{in} = 4.5\text{V}$ )	0.01 1.0 1.0	0.05 2.0 2.0	- - -	mA mA mA
Output Delay Time (Note 1)			$t_{pd}$	-	-	100	$\mu\text{s}$
Detector Threshold Temperature Coefficient ( $-40^\circ\text{C} \leq T_A \leq 85^\circ\text{C}$ )			$\Delta V_{DET-}/\Delta T$	-	$\pm 100$	-	PPM/ $^\circ\text{C}$

NOTES: 1. Refer to Figure 1 for test conditions for measurement.

## ELECTRICAL CHARACTERISTICS (For all values $T_A = 25^\circ\text{C}$ , unless otherwise noted.)

Characteristic	Symbol	Min	Typ	Max	Unit		
<b>MC33460/461 - 3.2</b>							
Detector Threshold ( $V_{in}$ Falling)	$V_{DET-}$	3.136	3.200	3.264	V		
Detector Threshold Hysteresis	$V_{HYS}$	0.096	0.160	0.224	V		
Supply Current ( $V_{in} = 3.07\text{ V}$ ) ( $V_{in} = 5.2\text{ V}$ )	$I_{in}$	- -	1.0 1.2	3.0 3.6	$\mu\text{A}$		
Maximum Operating Voltage	$V_{in(max)}$	-	-	10	V		
Minimum Operating Voltage ( $-40^\circ\text{C} \leq T_A \leq 85^\circ\text{C}$ )	$V_{in(min)}$	- -	0.55 0.65	0.70 0.80	V		
Output Current ( $\overline{\text{OUT}}$ ) Nch CMOS Output High	$I_{OUT}$		( $V_{out} = 0.05\text{V}, V_{in} = 0.70\text{V}$ ) ( $V_{out} = 0.50\text{V}, V_{in} = 1.5\text{V}$ ) ( $V_{out} = 2.4\text{V}, V_{in} = 4.5\text{V}$ )	0.01 1.0 1.0	0.05 2.0 2.0	- - -	mA mA mA
Output Delay Time (Note 1)			$t_{pd}$	-	-	100	$\mu\text{s}$
Detector Threshold Temperature Coefficient ( $-40^\circ\text{C} \leq T_A \leq 85^\circ\text{C}$ )			$\Delta V_{DET-}/\Delta T$	-	$\pm 100$	-	PPM/ $^\circ\text{C}$

NOTES: 1. Refer to Figure 1 for test conditions for measurement.

# MC33460, MC33461

## ELECTRICAL CHARACTERISTICS (For all values $T_A = 25^\circ\text{C}$ , unless otherwise noted.)

Characteristic	Symbol	Min	Typ	Max	Unit
<b>MC33460/461 - 4.1</b>					
Detector Threshold ( $V_{in}$ Falling)	$V_{DET-}$	4.018	4.1	4.182	V
Detector Threshold Hysteresis	$V_{HYS}$	0.135	0.225	0.315	V
Supply Current ( $V_{in} = 3.94\text{ V}$ ) ( $V_{in} = 6.1\text{ V}$ )	$I_{in}$	- -	1.1 1.3	3.3 3.9	$\mu\text{A}$
Maximum Operating Voltage	$V_{in(max)}$	-	-	10	V
Minimum Operating Voltage ( $-40^\circ\text{C} \leq T_A \leq 85^\circ\text{C}$ )	$V_{in(min)}$	- -	0.55 0.65	0.70 0.80	V
Output Current ( $\overline{\text{OUT}}$ ) Nch CMOS Output High	$I_{OUT}$				
( $V_{out} = 0.05\text{V}$ , $V_{in} = 0.70\text{V}$ )		0.01	0.05	-	mA
( $V_{out} = 0.50\text{V}$ , $V_{in} = 1.5\text{V}$ )		1.0	2.0	-	mA
( $V_{out} = 6.9\text{V}$ , $V_{in} = 8.0\text{V}$ )		1.5	3.0	-	mA
Output Delay Time (Note 1)	$t_{pd}$	-	-	100	$\mu\text{s}$
Detector Threshold Temperature Coefficient ( $-40^\circ\text{C} \leq T_A \leq 85^\circ\text{C}$ )	$\Delta V_{DET-}/\Delta T$	-	$\pm 100$	-	PPM/ $^\circ\text{C}$

NOTES: 1. Refer to Figure 1 for test conditions for measurement.

## ELECTRICAL CHARACTERISTICS (For all values $T_A = 25^\circ\text{C}$ , unless otherwise noted.)

Characteristic	Symbol	Min	Typ	Max	Unit
<b>MC33460/461 - 4.2</b>					
Detector Threshold ( $V_{in}$ Falling)	$V_{DET-}$	4.116	4.2	4.284	V
Detector Threshold Hysteresis	$V_{HYS}$	0.126	0.210	0.296	V
Supply Current ( $V_{in} = 4.04\text{ V}$ ) ( $V_{in} = 6.2\text{ V}$ )	$I_{in}$	- -	1.1 1.3	3.3 3.9	$\mu\text{A}$
Maximum Operating Voltage	$V_{in(max)}$	-	-	10	V
Minimum Operating Voltage ( $-40^\circ\text{C} \leq T_A \leq 85^\circ\text{C}$ )	$V_{in(min)}$	- -	0.55 0.65	0.70 0.80	V
Output Current ( $\overline{\text{OUT}}$ ) Nch CMOS Output High	$I_{OUT}$				
( $V_{out} = 0.05\text{V}$ , $V_{in} = 0.70\text{V}$ )		0.01	0.05	-	mA
( $V_{out} = 0.50\text{V}$ , $V_{in} = 1.5\text{V}$ )		1.0	2.0	-	mA
( $V_{out} = 2.4\text{V}$ , $V_{in} = 4.5\text{V}$ )		1.0	2.0	-	mA
Output Delay Time (Note 1)	$t_{pd}$	-	-	100	$\mu\text{s}$
Detector Threshold Temperature Coefficient ( $-40^\circ\text{C} \leq T_A \leq 85^\circ\text{C}$ )	$\Delta V_{DET-}/\Delta T$	-	$\pm 100$	-	PPM/ $^\circ\text{C}$

NOTES: 1. Refer to Figure 1 for test conditions for measurement.

# MC33460, MC33461

## ELECTRICAL CHARACTERISTICS (For all values $T_A = 25^\circ\text{C}$ , unless otherwise noted.)

Characteristic	Symbol	Min	Typ	Max	Unit
<b>MC33460/461 – 4.3</b>					
Detector Threshold ( $V_{in}$ Falling)	$V_{DET-}$	4.214	4.300	4.386	V
Detector Threshold Hysteresis	$V_{HYS}$	0.129	0.215	0.301	V
Supply Current ( $V_{in} = 4.14\text{ V}$ ) ( $V_{in} = 6.3\text{ V}$ )	$I_{in}$	– –	1.1 1.3	3.3 3.9	$\mu\text{A}$
Maximum Operating Voltage	$V_{in(max)}$	–	–	10	V
Minimum Operating Voltage ( $-40^\circ\text{C} \leq T_A \leq 85^\circ\text{C}$ )	$V_{in(min)}$	– –	0.55 0.65	0.70 0.80	V
Output Current ( $\overline{\text{OUT}}$ ) Nch ( $V_{out} = 0.05\text{V}$ , $V_{in} = 0.70\text{V}$ ) ( $V_{out} = 0.50\text{V}$ , $V_{in} = 1.5\text{V}$ ) CMOS Output High ( $V_{out} = 2.4\text{V}$ , $V_{in} = 4.5\text{V}$ )	$I_{OUT}$	0.01 1.0 1.0	0.05 2.0 2.0	– – –	mA mA mA
Output Delay Time (Note 1)	$t_{pd}$	–	–	100	$\mu\text{s}$
Detector Threshold Temperature Coefficient ( $-40^\circ\text{C} \leq T_A \leq 85^\circ\text{C}$ )	$\Delta V_{DET-}/\Delta T$	–	$\pm 100$	–	PPM/ $^\circ\text{C}$

NOTES: 1. Refer to Figure 1 for test conditions for measurement.

## ELECTRICAL CHARACTERISTICS (For all values $T_A = 25^\circ\text{C}$ , unless otherwise noted.)

Characteristic	Symbol	Min	Typ	Max	Unit
<b>MC33460/461 – 4.5</b>					
Detector Threshold ( $V_{in}$ Falling)	$V_{DET-}$	4.410	4.500	4.590	V
Detector Threshold Hysteresis	$V_{HYS}$	0.135	0.225	0.315	V
Supply Current ( $V_{in} = 4.34\text{ V}$ ) ( $V_{in} = 6.5\text{ V}$ )	$I_{in}$	– –	1.1 1.3	3.3 3.9	$\mu\text{A}$
Maximum Operating Voltage	$V_{in(max)}$	–	–	10	V
Minimum Operating Voltage ( $-40^\circ\text{C} \leq T_A \leq 85^\circ\text{C}$ )	$V_{in(min)}$	– –	0.55 0.65	0.70 0.80	V
Output Current ( $\overline{\text{OUT}}$ ) Nch ( $V_{out} = 0.05\text{V}$ , $V_{in} = 0.70\text{V}$ ) ( $V_{out} = 0.50\text{V}$ , $V_{in} = 1.5\text{V}$ ) CMOS Output High ( $V_{out} = 5.9\text{V}$ , $V_{in} = 8.0\text{V}$ )	$I_{OUT}$	0.01 1.0 1.5	0.05 2.0 3.0	– – –	mA mA mA
Output Delay Time (Note 1)	$t_{pd}$	–	–	100	$\mu\text{s}$
Detector Threshold Temperature Coefficient ( $-40^\circ\text{C} \leq T_A \leq 85^\circ\text{C}$ )	$\Delta V_{DET-}/\Delta T$	–	$\pm 100$	–	PPM/ $^\circ\text{C}$

NOTES: 1. Refer to Figure 1 for test conditions for measurement.



# MC33460, MC33461

## TYPICAL CHARACTERISTICS

### MC33461-0.9

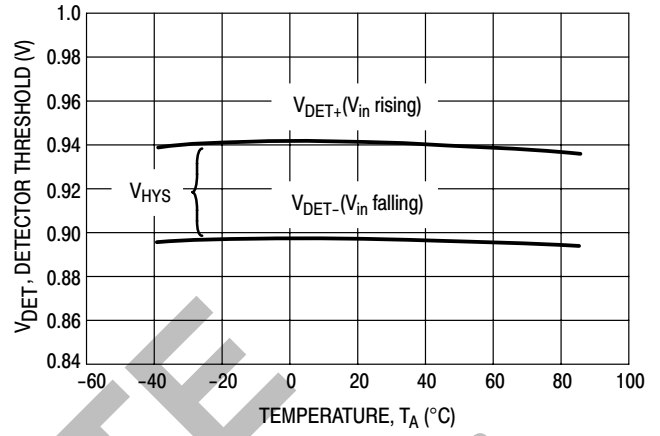
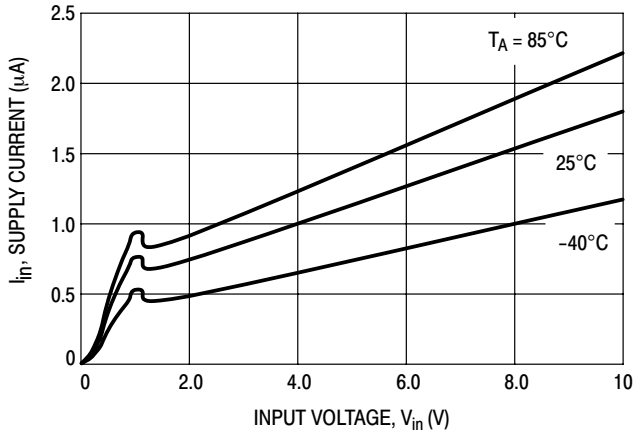

### MC33461-2.7

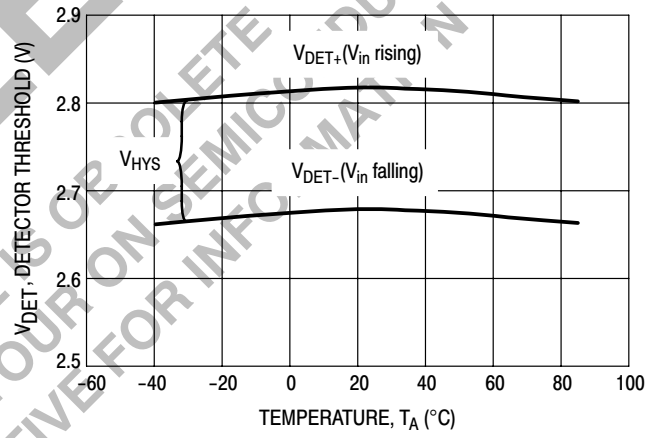
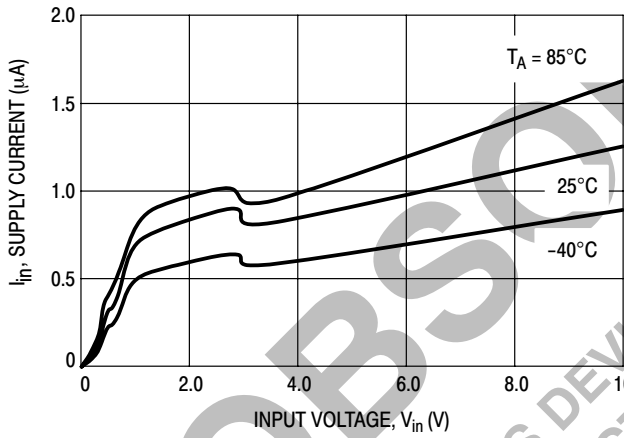

### MC33461-4.5

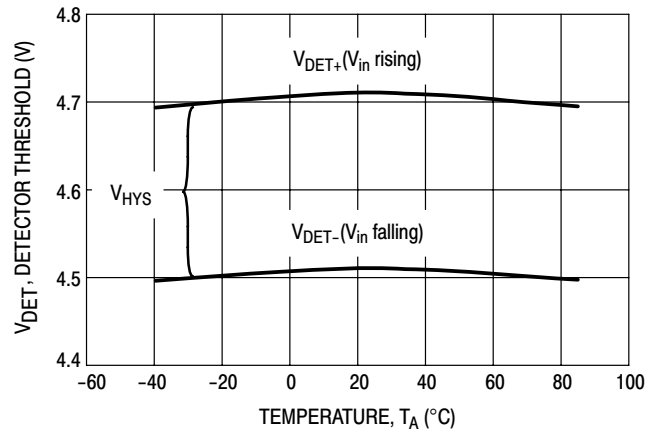
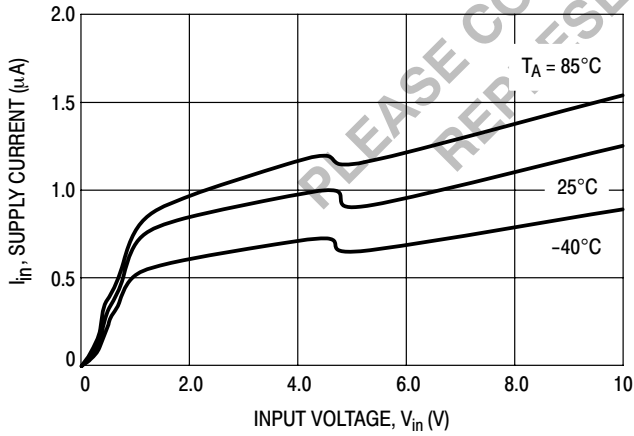
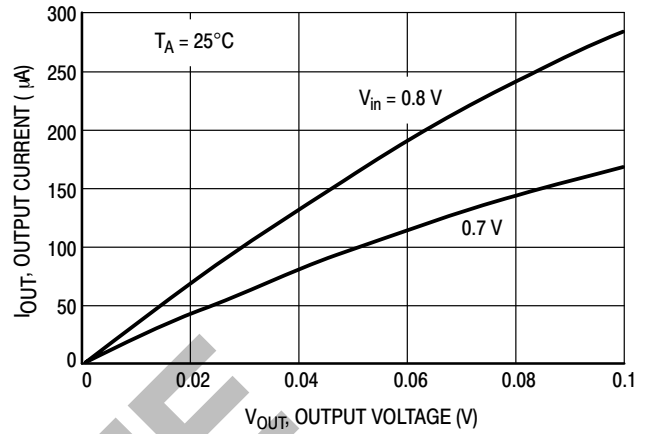
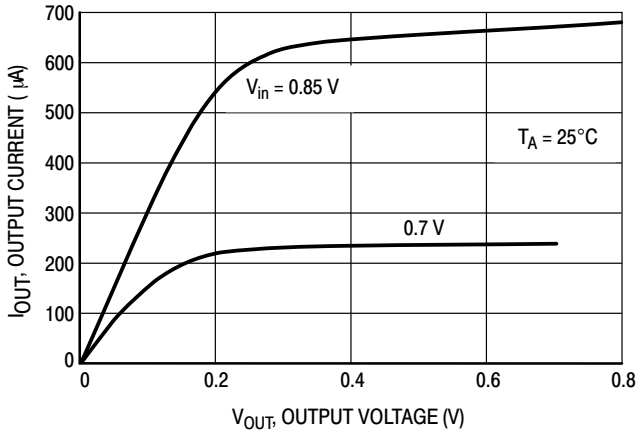

Figure 2. Supply Current vs. Input Voltage

Figure 3. Detector Threshold Hysteresis vs. Temperature

# MC33460, MC33461

## MC33461-0.9



## MC33461-2.7

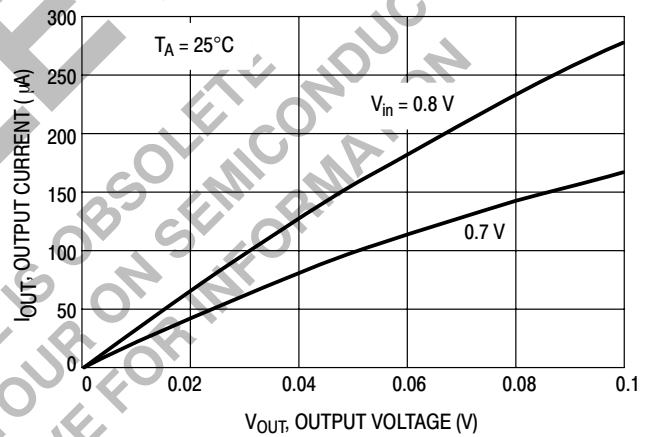
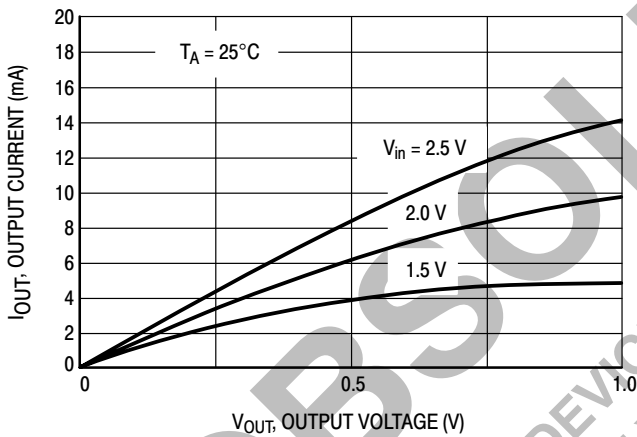

## MC33461-4.5

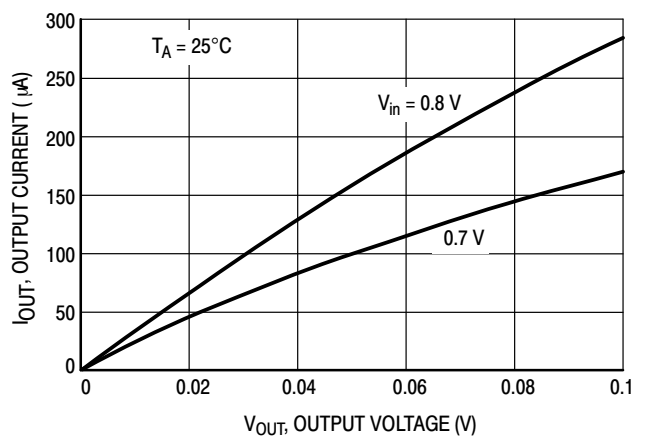
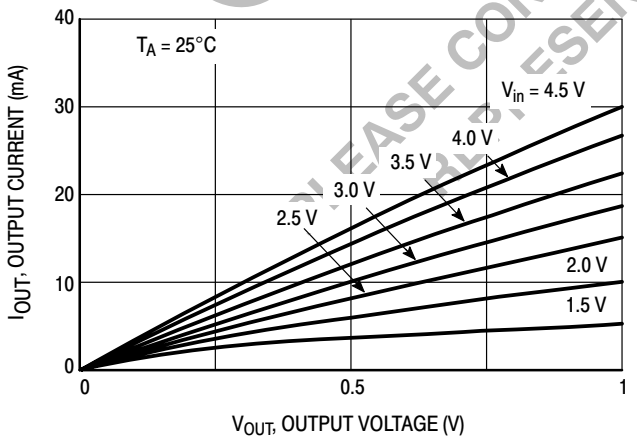
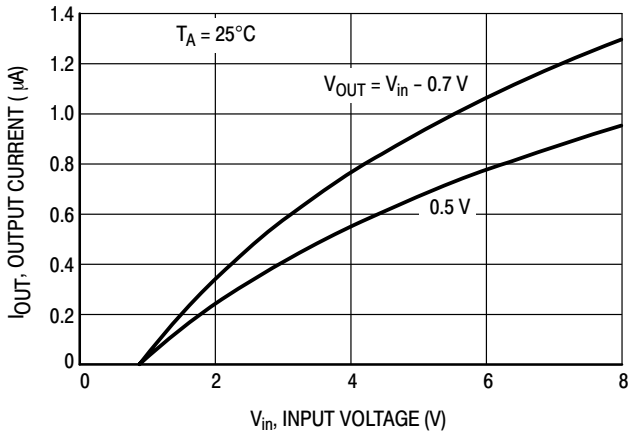

Figure 4. Nch Output Current versus  $V_{in}$

# MC33460, MC33461

MC33461-0.9



MC33461-2.7

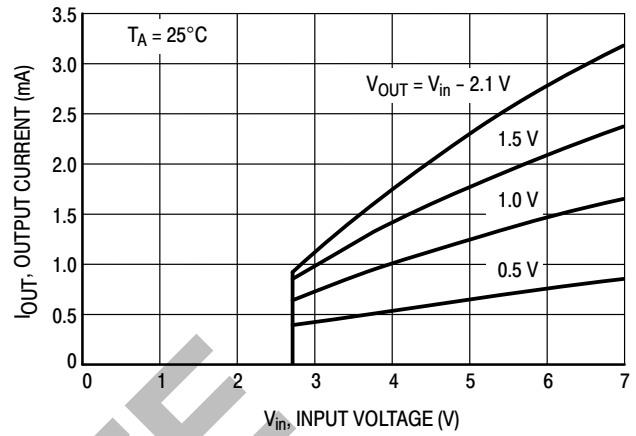

MC33461-4.5

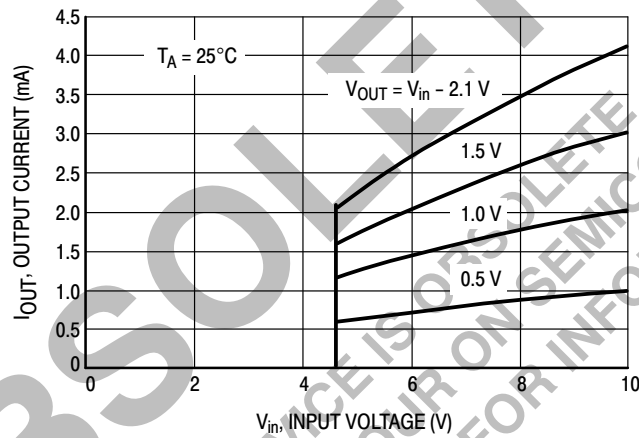
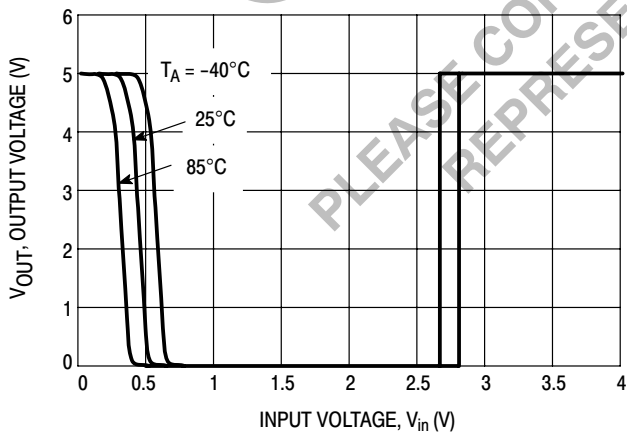

Figure 5. Output Current High versus Input Voltage

MC33460-2.7



MC33461-2.7

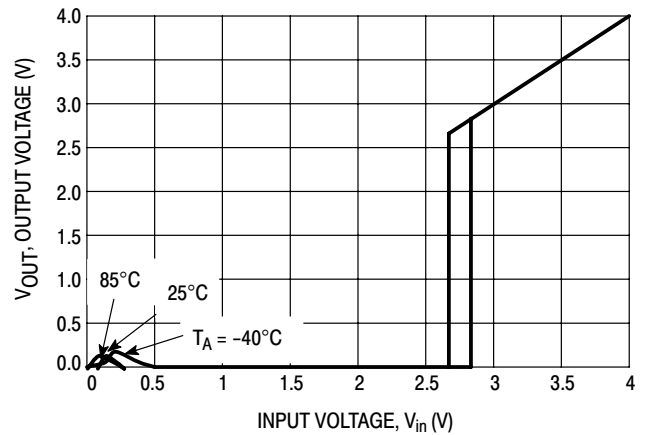

Figure 6. Typical Output Voltage versus Input Voltage

# MC33460, MC33461

MC33460-0.9

MC33460-2.7

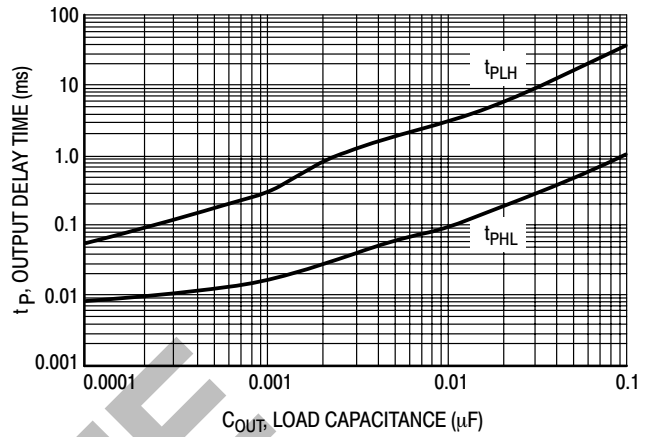
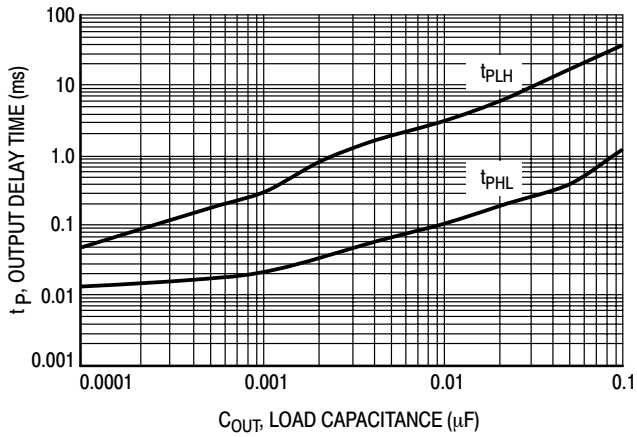

Figure 7. Output Delay Time versus Load Capacitance

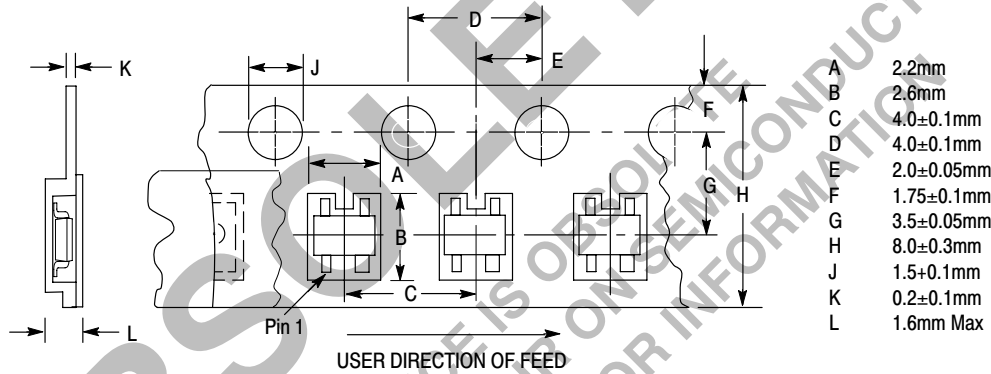

Figure 8. Taping Specifications

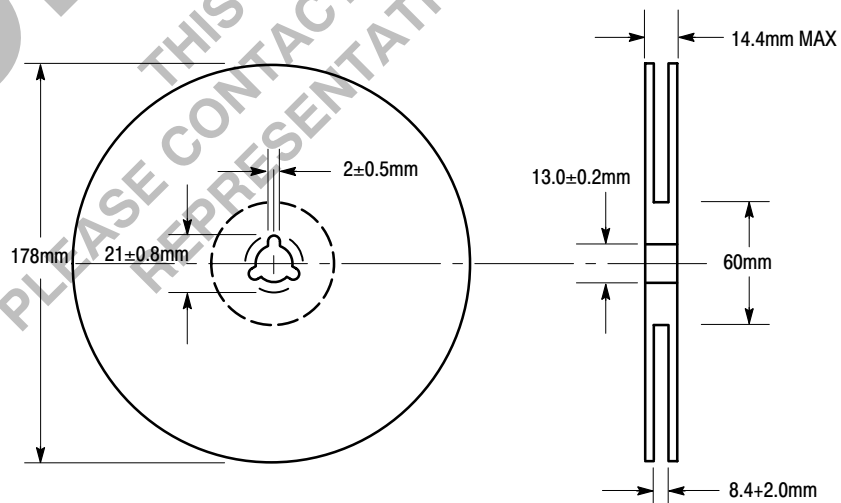

Figure 9. Reel Dimensions

## INFORMATION FOR USING THE SC-82AB SURFACE MOUNT PACKAGE

### MINIMUM RECOMMENDED FOOTPRINT FOR SURFACE MOUNTED APPLICATIONS

Surface mount board layout is a critical portion of the total design. The footprint for the semiconductor packages must be the correct size to insure proper solder connection

interface between the board and the package. With the correct pad geometry, the packages will self align when subjected to a solder reflow process.

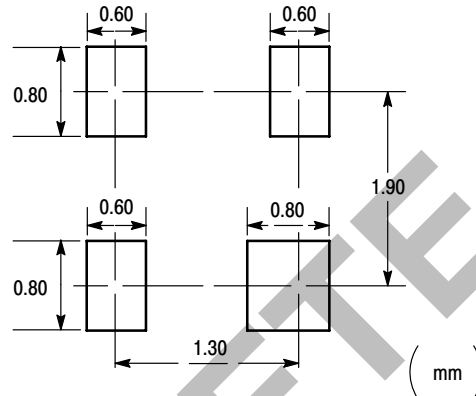

SC-82AB

### SOLDERING PRECAUTIONS

The melting temperature of solder is higher than the rated temperature of the device. When the entire device is heated to a high temperature, failure to complete soldering within a short time could result in device failure. Therefore, the following items should always be observed in order to minimize the thermal stress to which the devices are subjected.

- Always preheat the device.
- The delta temperature between the preheat and soldering should be 100°C or less.\*
- When preheating and soldering, the temperature of the leads and the case must not exceed the maximum temperature ratings as shown on the data sheet. When using infrared heating with the reflow soldering method, the difference shall be a maximum of 10°C.

- The soldering temperature and time shall not exceed 260°C for more than 10 seconds.
- When shifting from preheating to soldering, the maximum temperature gradient shall be 5°C or less.
- After soldering has been completed, the device should be allowed to cool naturally for at least three minutes. Gradual cooling should be used as the use of forced cooling will increase the temperature gradient and result in latent failure due to mechanical stress.
- Mechanical stress or shock should not be applied during cooling.

\* Soldering a device without preheating can cause excessive thermal shock and stress which can result in damage to the device.

# MC33460, MC33461

## PACKAGE DIMENSIONS

(SC-82AB)  
SQ SUFFIX  
PLASTIC PACKAGE  
CASE 419C-01  
ISSUE O

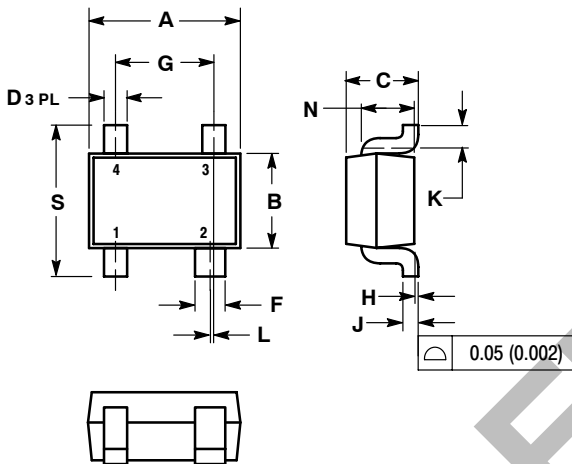

- NOTES:  
1. DIMENSIONING AND TOLERANCING PER ANSI Y14.5M, 1982.  
2. CONTROLLING DIMENSION: MILLIMETER.

DIM	MILLIMETERS		INCHES	
	MIN	MAX	MIN	MAX
A	1.8	2.2	0.071	0.087
B	1.15	1.45	0.045	0.057
C	0.8	1.1	0.031	0.043
D	0.2	0.4	0.008	0.016
F	0.3	0.5	0.012	0.020
G	1.1	1.5	0.043	0.059
H	0.0	0.1	0.000	0.004
J	0.10	0.26	0.004	0.010
K	0.1	---	0.004	---
L	0.05 BSC		0.002 BSC	
N	0.7 REF		0.028 REF	
S	1.8	2.4	0.07	0.09

OBSOLETE

THIS DEVICE IS OBSOLETE

PLEASE CONTACT YOUR ON SEMICONDUCTOR

REPRESENTATIVE FOR INFORMATION

**ON Semiconductor** and **ON** are registered trademarks of Semiconductor Components Industries, LLC (SCILLC). SCILLC reserves the right to make changes without further notice to any products herein. SCILLC makes no warranty, representation or guarantee regarding the suitability of its products for any particular purpose, nor does SCILLC assume any liability arising out of the application or use of any product or circuit, and specifically disclaims any and all liability, including without limitation special, consequential or incidental damages. "Typical" parameters which may be provided in SCILLC data sheets and/or specifications can and do vary in different applications and actual performance may vary over time. All operating parameters, including "Typicals" must be validated for each customer application by customer's technical experts. SCILLC does not convey any license under its patent rights nor the rights of others. SCILLC products are not designed, intended, or authorized for use as components in systems intended for surgical implant into the body, or other applications intended to support or sustain life, or for any other application in which the failure of the SCILLC product could create a situation where personal injury or death may occur. Should Buyer purchase or use SCILLC products for any such unintended or unauthorized application, Buyer shall indemnify and hold SCILLC and its officers, employees, subsidiaries, affiliates, and distributors harmless against all claims, costs, damages, and expenses, and reasonable attorney fees arising out of, directly or indirectly, any claim of personal injury or death associated with such unintended or unauthorized use, even if such claim alleges that SCILLC was negligent regarding the design or manufacture of the part. SCILLC is an Equal Opportunity/Affirmative Action Employer. This literature is subject to all applicable copyright laws and is not for resale in any manner.

### PUBLICATION ORDERING INFORMATION

**LITERATURE FULFILLMENT:**  
Literature Distribution Center for ON Semiconductor  
P.O. Box 5163, Denver, Colorado 80217 USA  
**Phone:** 303-675-2175 or 800-344-3860 Toll Free USA/Canada  
**Fax:** 303-675-2176 or 800-344-3867 Toll Free USA/Canada  
**Email:** orderlit@onsemi.com

**N. American Technical Support:** 800-282-9855 Toll Free  
USA/Canada  
**Europe, Middle East and Africa Technical Support:**  
Phone: 421 33 790 2910  
**Japan Customer Focus Center**  
Phone: 81-3-5773-3850

**ON Semiconductor Website:** [www.onsemi.com](http://www.onsemi.com)  
**Order Literature:** <http://www.onsemi.com/orderlit>

For additional information, please contact your local Sales Representative