

QuickSwitch® Products

High-Speed CMOS 12-Bit 2:1 Mux/Demux Switch With Resistor Termination on the Demux Side

QS316292
 QS3162292

FEATURES/BENEFITS

- Enhanced N channel FET with no inherent diode to V_{CC}
- 5Ω bidirectional switches connect inputs to outputs
- Zero propagation delay, zero ground bounce
- TTL-compatible input and output levels
- Undershoot Clamp diodes on all switch and control inputs
- Available in 56-pin SSOP and TSSOP

DESCRIPTION

The QS316292 and QS3162292 are high-speed CMOS 12-Bit 2:1 Multiplexer/Demultiplexer switches with a 500Ω resistor termination to GND on the Demultiplexer side to eliminate floating nodes. The QS316292 adds a 25Ω series damping resistor to minimize undershoot, reflection noise, and charge sharing effects. The low ON resistance of the QS316292 allows inputs to be connected to outputs without adding propagation delay and without generating additional ground bounce noise.

APPLICATIONS

- Resource sharing
- Hot-docking (Application Note AN-13)
- Voltage translation (5V to 3.3V; Application Note AN-11)

5

Figure 1. Functional Block Diagram

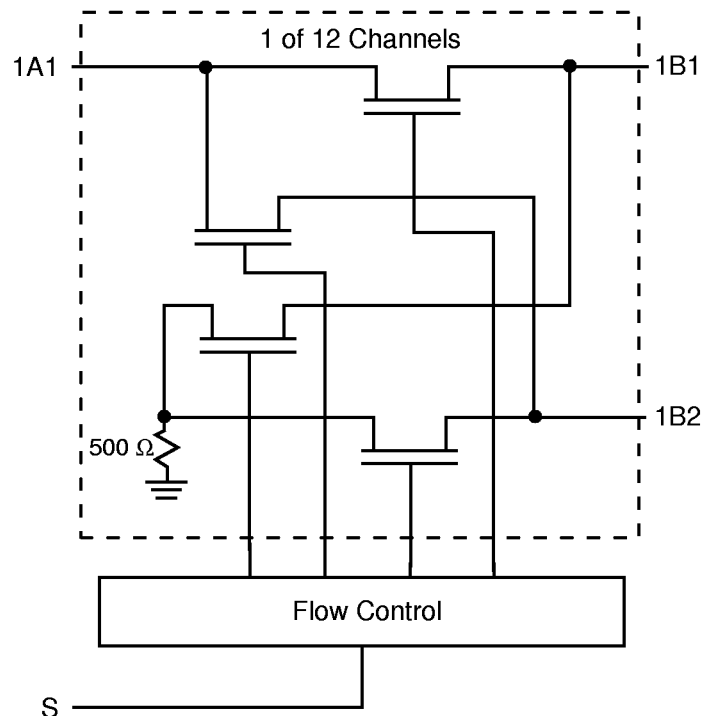

Table 1. Pin Description

Name	I/O	Function
1A1-12A1	I/O	Bus A
1Bn-12Bn	I/O	Bus B
S	I	Data select

Table 2. Function Table

S	iA1	Function
L	iB1	iA1 to iB1, iB2 to GND Via 500Ω
H	iB2	iA1 to iB2, iB1 to GND Via 500Ω

**Figure 2. Pin Configuration
(All Pins Top View)
SSOP (PV)
TSSOP (PA)**

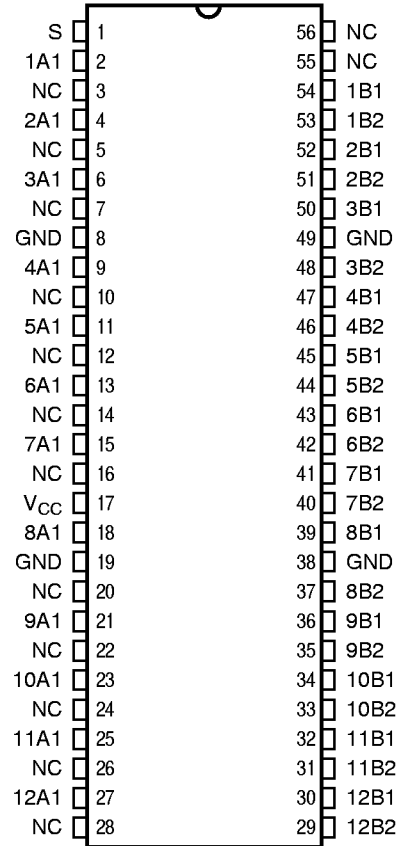

Table 3. Absolute Maximum Ratings

Supply Voltage to Ground	-0.5V to +7.0V
DC Switch Voltage V_S	-0.5V to +7.0V
DC Input Voltage V_{IN}	-0.5V to +7.0V
AC Input Voltage (for a pulse width ≤ 20 ns)	-3.0V
DC Output Current Max. Sink Current/Pin	120mA
Maximum Power Dissipation At $T_A = 85^\circ\text{C}$, SSOP	0.93 watts
TSSOP	0.77 watts
T_{STG} Storage Temperature	-65° to +150°C

Note: ABSOLUTE MAXIMUM CONTINUOUS RATINGS are those values beyond which damage to the device may occur. Exposure to these conditions or conditions beyond those indicated may adversely affect device reliability. Functional operation under absolute-maximum conditions is not implied.

Table 4. Capacitance

$T_A = 25^\circ\text{C}$, $f = 1\text{MHz}$, $V_{IN} = 0\text{V}$, $V_{OUT} = 0\text{V}$

Pins	SSOP, TSSOP		Unit
	Typ	Max	
Control Inputs	4	5	pF
QuickSwitch Channels (Switch OFF)	7.5	9	pF

Note: Capacitance is guaranteed, but not production tested. For total capacitance while the switch is ON, please see Section 1 under "Input and Switch Capacitance."

Table 5. DC Electrical Characteristics Over Operating Range

$T_A = -40^{\circ}\text{C}$ to 85°C , $V_{CC} = 5.0\text{V} \pm 10\%$

Symbol	Parameter	Test Conditions	Min	Typ ⁽¹⁾	Max	Unit	
V_{IH}	Input HIGH Voltage	Guaranteed Logic HIGH for Control Inputs	2.0	—	—	V	
V_{IL}	Input LOW Voltage	Guaranteed Logic LOW for Control Inputs	—	—	0.8	V	
$ I_{IN} $	Input Leakage Current (Control Inputs)	$0 \leq V_{IN} \leq V_{CC}$	—	—	1	μA	
I_{OS}	Short Circuit Current	A(B) = 0V B(A) = V_{CC}	-100	—	—	mA	
V_{IK}	Clamp Diode Voltage	$V_{CC} = \text{Min.}$, $I_{IN} = -18\text{mA}$	—	-0.7	-1.2	V	
V_H	Input Hysteresis at Control Pins		—	150	—	mV	
R_{ON}	Switch ON Resistance ⁽²⁾	$V_{CC} = \text{Min.}$, $V_{IN} = 0.0\text{V}$ $I_{ON} = 30\text{mA}$	QS316292	—	4	6	Ω
			QS3162292	20	28	40	
R_{ON}	Switch ON Resistance ⁽²⁾	$V_{CC} = \text{Min.}$, $V_{IN} = 2.4\text{V}$ $I_{ON} = 15\text{mA}$	QS316292	—	8	12	Ω
			QS3162292	20	35	48	
V_P	Pass Voltage ⁽³⁾	$V_{IN} = V_{CC} = 5\text{V}$, $I_{OUT} = -5\mu\text{A}$	3.7	4	4.2	V	

5

Notes:

1. Typical values indicate $V_{CC} = 5.0\text{V}$ and $T_A = 25^{\circ}\text{C}$.
2. For a diagram explaining the procedure for R_{ON} measurement, please see Section 1 under “DC Electrical Characteristics.” Max. value of R_{ON} guaranteed, but not production tested.
3. Pass voltage is guaranteed, but not production tested.

Figure 3. Typical ON Resistance vs. V_{IN} at $V_{CC} = 5.0\text{V}$ (QS316292)

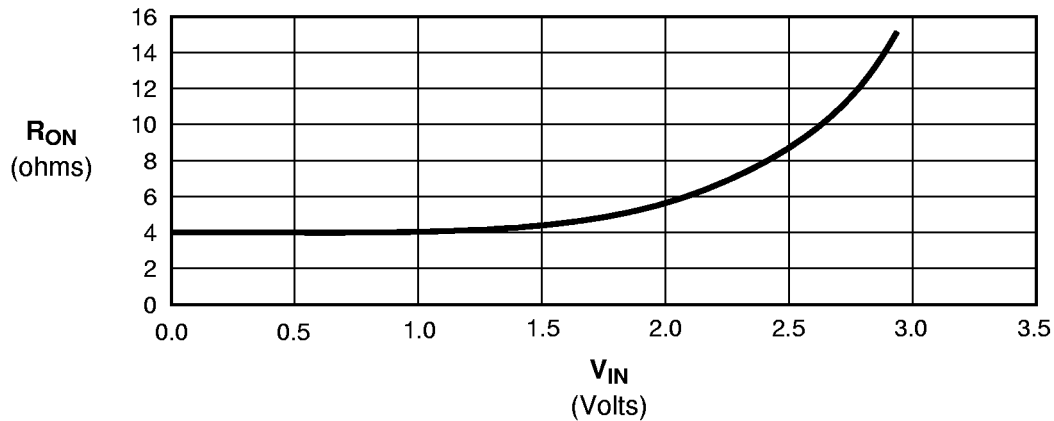

Note: For QS3162292, add 23Ω to R_{ON} shown.

Table 6. Power Supply Characteristics Over Operating Range

$T_A = -40^{\circ}\text{C}$ to 85°C , $V_{CC} = 5.0\text{V} \pm 10\%$

Symbol	Parameter	Test Conditions ⁽¹⁾	Typ	Max	Unit
I_{CCQ}	Quiescent Power Supply Current	$V_{CC} = \text{Max.}$, $V_{IN} = \text{GND}$ or V_{CC} , $f = 0$	0.1	3.0	μA
ΔI_{CC}	Power Supply Current Per Control Input HIGH ⁽²⁾	$V_{CC} = \text{Max.}$, $V_{IN} = 3.4\text{V}$, $f = 0$	—	1.5	mA
Q_{CCD}	Dynamic Power Supply Current Per MHz ⁽³⁾	$V_{CC} = \text{Max.}$, A and B Pins Open, Control Input Toggling @ 50% Duty Cycle	—	0.25	mA/MHz

Notes:

1. For conditions shown as Min. or Max., use the appropriate values specified under DC specifications.
2. Per TTL driven input ($V_{IN} = 3.4\text{V}$). A and B pins do not contribute to ΔI_{CC} .
3. This current applies to the control inputs only and represents the current required to switch internal capacitance at the specified frequency. The A and B inputs generate no significant AC or DC currents as they transition. This parameter is guaranteed, but not production tested.

Table 7. Switching Characteristics Over Operating Range

$T_A = -40^{\circ}\text{C}$ to 85°C , $V_{CC} = 5.0\text{V} \pm 10\%$

$C_{LOAD} = 50\text{pF}$, $R_{LOAD} = 500\Omega$ unless otherwise noted.

Symbol	Description ⁽¹⁾		Min	Typ	Max	Unit
t_{PLH} t_{PHL}	Data Propagation Delay ^(2,3) iA1 to iBn, iBn to iA1	QS316292	—	—	0.25	ns
		QS3162292	—	—	1.25	
t_{PZL} t_{PZH}	Switch Turn-on Delay S to iA1 or iBn	QS316292	1.5	—	6.7	ns
		QS3162292	1.5	—	7.7	
t_{PLZ} t_{PHZ}	Switch Turn-off Delay ⁽²⁾ S to iA1, iBn	QS316292	1.5	—	6.2	ns
		QS3162292	1.5	—	6.8	

Notes:

1. See Test Circuit and Waveforms. Minimums guaranteed but not production tested.
2. This parameter is guaranteed, but not production tested.
3. The bus switch contributes no propagation delay other than the RC delay of the ON resistance of the switch and the load capacitance. The time constant for the switch alone is of the order of 0.25ns for QS316292 and 1.25ns for QS3162292 for $C_L = 50\text{pF}$. Since this time constant is much smaller than the rise/fall times of typical driving signals, it adds very little propagation delay to the system. Propagation delay of the bus switch when used in a system is determined by the driving circuit on the driving side of the switch and its interaction with the load on the driven side.

300-MIL SSOP - Package Code PV

**Shrink Small Outline Package
Plastic Small Outline Gull-Wing**

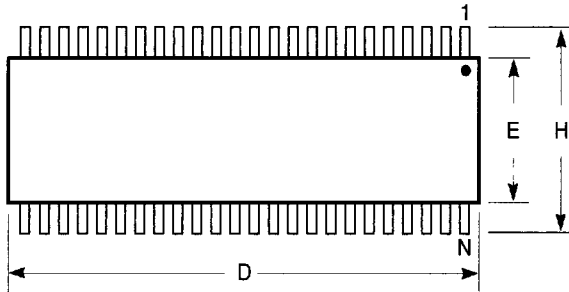

Notes:

1. Refer to applicable symbol list.
2. All dimensions are in inches.
3. N is the number of lead positions.
4. Dimensions D and E are to be measured at maximum material condition but do not include mold flash. Allowable mold flash is 0.006in. per side.
5. Lead coplanarity is 0.004in. maximum.

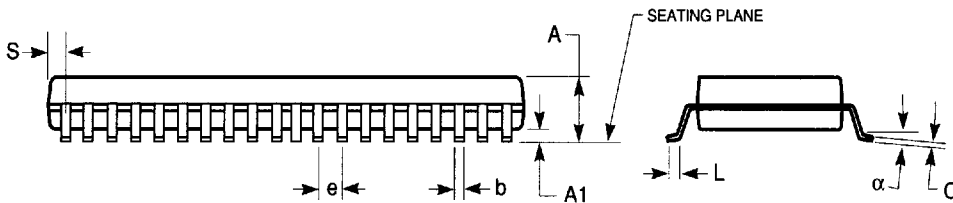

JEDEC#	MO-118AA			MO-118AB		
DWG#	PSS-48B			PSS-56B		
Symbol	Min	Nom	Max	Min	Nom	Max
A	0.095	0.102	0.110	0.095	0.102	0.110
A1	0.008	0.012	0.016	0.008	0.012	0.016
b	0.008	0.010	0.0135	0.008	0.010	0.0135
C	0.005	0.008	0.010	0.005	0.008	0.010
D	0.620	0.625	0.630	0.720	0.725	0.730
E	0.291	0.295	0.299	0.291	0.295	0.299
e	0.025 BSC			0.025 BSC		
H	0.395	0.410	0.420	0.395	0.410	0.420
L	0.020	0.030	0.040	0.020	0.030	0.040
N	48			56		
α	0°	5°	8°	0°	5°	8°
S	0.022	0.025	0.028	0.022	0.025	0.028

240-MIL TSSOP - Package Code PA
Thin Shrink Small Outline Package
Plastic Small Outline Gull-Wing

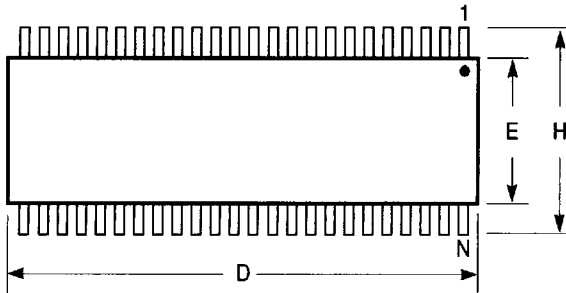

Notes:

1. Refer to applicable symbol list.
2. N is the number of lead positions.
3. Dimensions D, E, and S are to be measured at maximum material condition but do not include mold flash. Allowable mold flash is 0.006 in. per side.
4. Lead coplanarity is 0.004in. maximum.

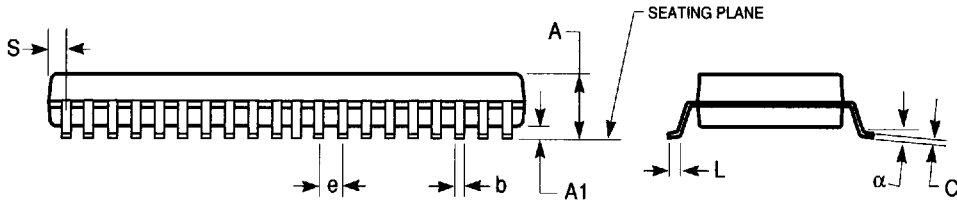

JEDEC#	MO-153ED			MO-153EE			MO-153ED			MO-153EE		
DWG#	PSS-48C			PSS-56C			PSS-48C			PSS-56C		
Symbol	Min	Nom	Max	Min	Nom	Max	Min	Nom	Max	Min	Nom	Max
A	0.039	0.043	0.047	0.039	0.043	0.047	1.00	1.10	1.20	1.00	1.10	1.20
A1	0.002	0.004	0.006	0.002	0.004	0.006	0.05	0.10	0.15	0.05	0.10	0.15
b	0.006	0.008	0.011	0.006	0.008	0.011	0.17	0.20	0.27	0.17	0.20	0.27
C	0.004	0.006	0.008	0.004	0.006	0.008	0.09	0.15	0.20	0.09	0.15	0.20
D	0.488	0.492	0.496	0.547	0.551	0.555	12.40	12.50	12.60	13.90	14.00	14.10
E	0.236	0.240	0.244	0.236	0.240	0.244	6.00	6.10	6.20	6.00	6.10	6.20
e	0.0197 BSC			0.0197 BSC			0.50 BSC			0.50 BSC		
H	0.315	0.319	0.323	0.315	0.319	0.323	8.00	8.10	8.20	8.00	8.10	8.20
L	0.018	0.024	0.030	0.018	0.024	0.030	0.45	0.60	0.75	0.45	0.60	0.75
N	48			56			48			56		
alpha	0°	5°	8°	0°	5°	8°	0°	5°	8°	0°	5°	8°
S	0.015	0.020	0.025	0.006	0.010	0.014	0.38	0.50	0.65	0.15	0.25	0.35

DIMENSIONS IN INCHES

DIMENSIONS IN MILLIMETERS

7466803 0003757 T&T

QUALITY SEMICONDUCTOR, INC.