



Integrated Device Technology, Inc.

FAST CMOS 1-OF-8 DECODER WITH ENABLE

IDT54/74FCT138
IDT54/74FCT138A
IDT54/74FCT138C

FEATURES:

- IDT54/74FCT138 equivalent to FAST™ speed
- **IDT54/74FCT138A 35% faster than FAST**
- **IDT54/74FCT138C 40% faster than FAST**
- Equivalent to FAST speeds output drive over full temperature and voltage supply extremes
- $I_{OL} = 48mA$ (commercial) and $32mA$ (military)
- CMOS power levels (1mW typ. static)
- TTL input and output level compatible
- CMOS output level compatible
- Substantially lower input current levels than FAST ($5\mu A$ max.)
- JEDEC standard pinout for DIP and LCC
- Product available in Radiation Tolerant and Radiation Enhanced versions
- Military product compliant to MIL-STD-883, Class B
- Standard Military Drawing # 5962-87654 is listed on this function. Refer to section 2.

DESCRIPTION:

The IDT54/74FCT138/A/C are 1-of-8 decoders built using an advanced dual metal CMOS technology. The IDT54/74FCT138/A/C accept three binary weighted inputs (A_0 , A_1 , A_2) and, when enabled, provide eight mutually exclusive active LOW outputs ($\bar{O}_0 - \bar{O}_7$). The IDT54/74FCT138/A/C feature three enable inputs, two active LOW (\bar{E}_1 , \bar{E}_2) and one active HIGH (E_3). All outputs will be HIGH unless \bar{E}_1 and \bar{E}_2 are LOW and E_3 is HIGH. This multiple enable function allows easy parallel expansion of the device to a 1-of-32 (5 lines to 32 lines) decoder with just four IDT54/74FCT138/A/C devices and one inverter.

FUNCTIONAL BLOCK DIAGRAM

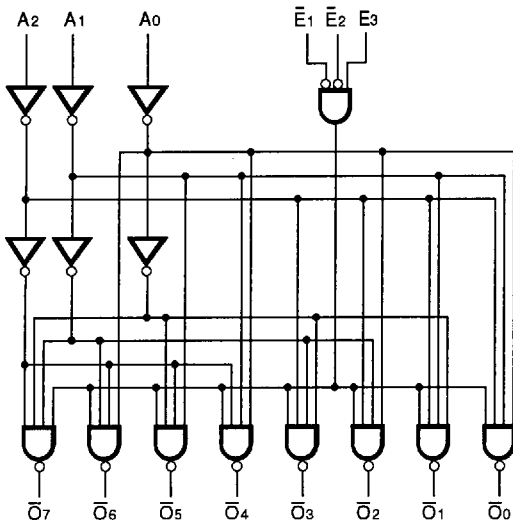

2581 drw 02

PIN CONFIGURATIONS

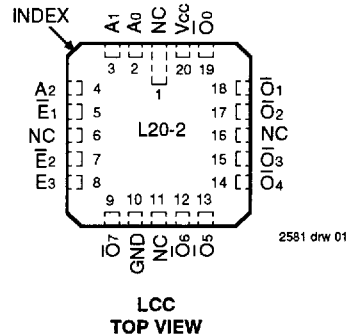
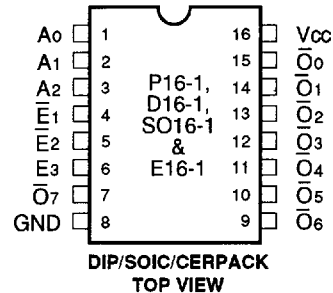

2581 drw 01

The IDT logo is a registered trademark of Integrated Device Technology, Inc.
FAST is a trademark of National Semiconductor Co.

MILITARY AND COMMERCIAL TEMPERATURE RANGES

MAY 1992

PIN DESCRIPTION

Pin Names	Description
A0-A2	Address Inputs
E1, E2	Enable Inputs (Active LOW)
E3	Enable Input (Active HIGH)
O0-O7	Outputs (Active LOW)

2581 tbl 05

FUNCTION TABLE

Inputs						Outputs							
E1	E2	E3	A0	A1	A2	O0	O1	O2	O3	O4	O5	O6	O7
H	X	X	X	X	X	H	H	H	H	H	H	H	H
X	H	X	X	X	X	H	H	H	H	H	H	H	H
X	X	L	X	X	X	H	H	H	H	H	H	H	H
L	L	H	L	L	L	L	H	H	H	H	H	H	H
L	L	H	H	L	L	H	L	H	H	H	H	H	H
L	L	H	L	H	L	H	H	L	H	H	H	H	H
L	L	H	H	H	L	H	H	H	L	H	H	H	H
L	L	H	L	L	H	H	H	H	H	L	H	H	H
L	L	H	H	L	H	H	H	H	H	H	L	H	H
L	L	H	L	H	H	H	H	H	H	H	H	L	H
L	L	H	H	H	H	H	H	H	H	H	H	H	L

2581 tbl 06

ABSOLUTE MAXIMUM RATINGS⁽¹⁾

Symbol	Rating	Commercial	Military	Unit
V _{TERM} ⁽²⁾	Terminal Voltage with Respect to GND	-0.5 to +7.0	-0.5 to +7.0	V
V _{TERM} ⁽³⁾	Terminal Voltage with Respect to GND	-0.5 to V _{CC}	-0.5 to V _{CC}	V
T _A	Operating Temperature	0 to +70	-55 to +125	°C
T _{BIAS}	Temperature Under Bias	-55 to +125	-65 to +135	°C
T _{STG}	Storage Temperature	-55 to +125	-65 to +150	°C
P _T	Power Dissipation	0.5	0.5	W
I _{OUT}	DC Output Current	120	120	mA

NOTES: 2581 tbl 01

- Stresses greater than those listed under ABSOLUTE MAXIMUM RATINGS may cause permanent damage to the device. This is a stress rating only and functional operation of the device at these or any other conditions above those indicated in the operational sections of this specification is not implied. Exposure to absolute maximum rating conditions for extended periods may affect reliability. No terminal voltage may exceed V_{CC} by +0.5V unless otherwise noted.
- Inputs and V_{CC} terminals only.
- Outputs and I/O terminals only.

CAPACITANCE (T_A = +25°C, f = 1.0MHz)

Symbol	Parameter ⁽¹⁾	Conditions	Typ.	Max.	Unit
C _{IN}	Input Capacitance	V _{IN} = 0V	6	10	pF
C _{OUT}	Output Capacitance	V _{OUT} = 0V	8	12	pF

NOTE: 2581 tbl 02
1. This parameter is guaranteed characterization data and not tested.

7

DC ELECTRICAL CHARACTERISTICS OVER OPERATING RANGE

Following Conditions Apply Unless Otherwise Specified: $V_{LC} = 0.2V$; $V_{HC} = V_{CC} - 0.2V$
Commercial: $T_A = 0^\circ C$ to $+70^\circ C$, $V_{CC} = 5.0V \pm 5\%$; Military: $T_A = -55^\circ C$ to $+125^\circ C$, $V_{CC} = 5.0V \pm 10\%$

Symbol	Parameter	Test Conditions ⁽¹⁾	Min.	Typ. ⁽²⁾	Max.	Unit
V _{IH}	Input HIGH Level	Guaranteed Logic HIGH Level	2.0	—	—	V
V _{IL}	Input LOW Level	Guaranteed Logic LOW Level	—	—	0.8	V
I _{IH}	Input HIGH Current	V _{CC} = Max. V _I = V _{CC} V _I = 2.7V V _I = 0.5V V _I = GND	—	—	5	μA
I _{IL}	Input LOW Current		—	—	5 ⁽⁴⁾	
			—	—	-5 ⁽⁴⁾	
V _{IK}	Clamp Diode Voltage	V _{CC} = Min., I _N = -18mA	—	-0.7	-1.2	V
I _{OS}	Short Circuit Current	V _{CC} = Max. ⁽³⁾ , V _O = GND	-60	-120	—	mA
V _{OH}	Output HIGH Voltage	V _{CC} = 3V, V _{IN} = V _{LC} or V _{HC} , I _{OH} = -32μA V _{CC} = Min. V _{IN} = V _{IH} or V _{IL}	V _{HC}	V _{CC}	—	V
		I _{OH} = -300μA	V _{HC}	V _{CC}	—	
		I _{OH} = -12mA MIL. I _{OH} = -15mA COM'L.	2.4	4.3	—	
V _{OL}	Output LOW Voltage	V _{CC} = 3V, V _{IN} = V _{LC} or V _{HC} , I _{OL} = 300μA V _{CC} = Min. V _{IN} = V _{IH} or V _{IL}	—	GND	V _{LC}	V
		I _{OL} = 300μA	—	GND	V _{LC} ⁽⁴⁾	
		I _{OL} = 32mA MIL. I _{OL} = 48mA COM'L.	—	0.3	0.5	

NOTES:

- For conditions shown as Max. or Min., use appropriate value specified under Electrical Characteristics for the applicable device type.
- Typical values are at V_{CC} = 5.0V, +25°C ambient and maximum loading.
- Not more than one output should be shorted at one time. Duration of the short circuit test should not exceed one second.
- This parameter is guaranteed but not tested.

2581 tbi 03

POWER SUPPLY CHARACTERISTICS

V_{LC} = 0.2V; V_{HC} = V_{CC} - 0.2V

Symbol	Parameter	Test Conditions ⁽¹⁾	Min.	Typ. ⁽²⁾	Max.	Unit	
I _{CC}	Quiescent Power Supply Current	V _{CC} = Max. V _{IN} ≥ V _{HC} ; V _{IN} ≤ V _{LC}	—	0.2	1.5	mA	
ΔI _{CC}	Quiescent Power Supply Current TTL Inputs HIGH	V _{CC} = Max. V _{IN} = 3.4V ⁽³⁾	—	0.5	2.0	mA	
I _{CCD}	Dynamic Power Supply Current ⁽⁴⁾	V _{CC} = Max. Outputs Open One Output Toggling 50% Duty Cycle	V _{IN} ≥ V _{HC} V _{IN} ≤ V _{LC}	—	0.15	0.3	mA/MHz
I _C	Total Power Supply Current ⁽⁵⁾	V _{CC} = Max. Outputs Open Toggle E ₁ , E ₂ or E ₃ 50% Duty Cycle fo = 10MHz One Output Toggling	V _{IN} ≥ V _{HC} V _{IN} ≤ V _{LC} (FCT) V _{IN} = 3.4V V _{IN} = GND	—	1.7	4.5	mA
				—	2.0	5.5	

NOTES:

- For conditions shown as Max. or Min., use appropriate value specified under Electrical Characteristics for the applicable device type.
- Typical values are at V_{CC} = 5.0V, +25°C ambient.
- Per TTL driven input (V_{IN} = 3.4V); all other inputs at V_{CC} or GND.
- This parameter is not directly testable, but is derived for use in Total Power Supply calculations.
- I_C = I_{QUIESCENT} + I_{INPUTS} + I_{DYNAMIC}
I_C = I_{CC} + ΔI_{CC} DH_{NT} + I_{CCD} (f_{CP}/2 + f_{ON})
I_{CC} = Quiescent Current
ΔI_{CC} = Power Supply Current for a TTL High Input (V_{IN} = 3.4V)
DH = Duty Cycle for TTL Inputs High
NT = Number of TTL Inputs at DH
I_{CCD} = Dynamic Current Caused by an Output Transition Pair (HLH or LHL)
f_{CP} = Clock Frequency for Register Devices (Zero for Non-Register Devices)
fo = Output Frequency
NO = Number of Outputs at fo
All currents are in milliamps and all frequencies are in megahertz.

2581 tbi 04

SWITCHING CHARACTERISTICS OVER OPERATING RANGE

Symbol	Parameter	Condition ⁽¹⁾	IDT54/74FCT138				IDT54/74FCT138A				IDT54/74FCT138C				Unit
			Com'l.		Mil.		Com'l.		Mil.		Com'l.		Mil.		
			Min. ⁽²⁾	Max.	Min. ⁽²⁾	Max.	Min. ⁽²⁾	Max.	Min. ⁽²⁾	Max.	Min. ⁽²⁾	Max.	Min. ⁽²⁾	Max.	
tPLH tPHL	Propagation Delay A _n to \bar{O}_n	CL = 50pF RL = 500Ω	1.5	9.0	1.5	12.0	1.5	5.8	1.5	7.8	1.5	5.1	1.5	6.0	ns
tPLH tPHL	Propagation Delay E ₁ or E ₂ to \bar{O}_n		1.5	9.0	1.5	12.5	1.5	5.9	1.5	8.0	1.5	5.2	1.5	6.1	ns
tPLH tPHL	Propagation Delay E ₃ to \bar{O}_n		1.5	9.0	1.5	12.5	1.5	5.9	1.5	8.0	1.5	5.2	1.5	6.1	ns

NOTES:

1. See test circuit and waveforms.
2. Minimum limits are guaranteed but not tested on Propagation Delays.

2581 tbl 07

TEST CIRCUITS AND WAVEFORMS

TEST CIRCUITS FOR ALL OUTPUTS

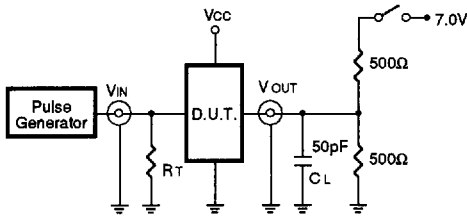

SWITCH POSITION

Test	Switch
Open Drain Disable Low Enable Low	Closed
All Other Test	Open

DEFINITIONS:

CL = Load capacitance: includes jig and probe capacitance.
RT = Termination resistance: should be equal to ZOUT of the Pulse Generator.

2581 tbl 08

SET-UP, HOLD AND RELEASE TIMES

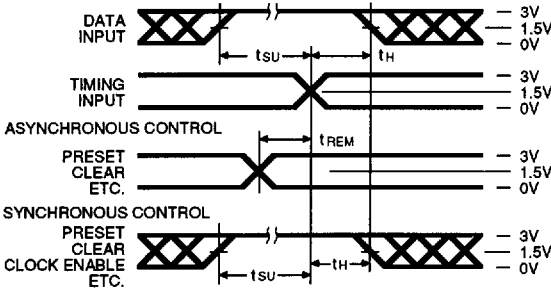

PULSE WIDTH

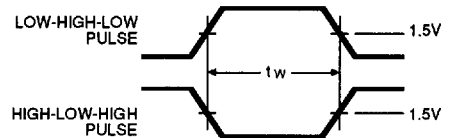

PROPAGATION DELAY

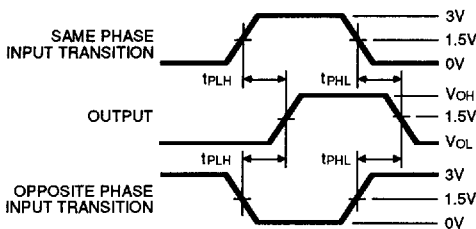

ENABLE AND DISABLE TIMES

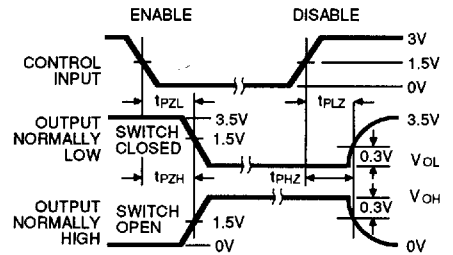

NOTES

2581 drw 04

1. Diagram shown for input Control Enable-LOW and input Control Disable-HIGH.
2. Pulse Generator for All Pulses: Rate \leq 1.0 MHz; Z_o \leq 50Ω; t_r \leq 2.5ns; t_r \leq 2.5ns.

ORDERING INFORMATION

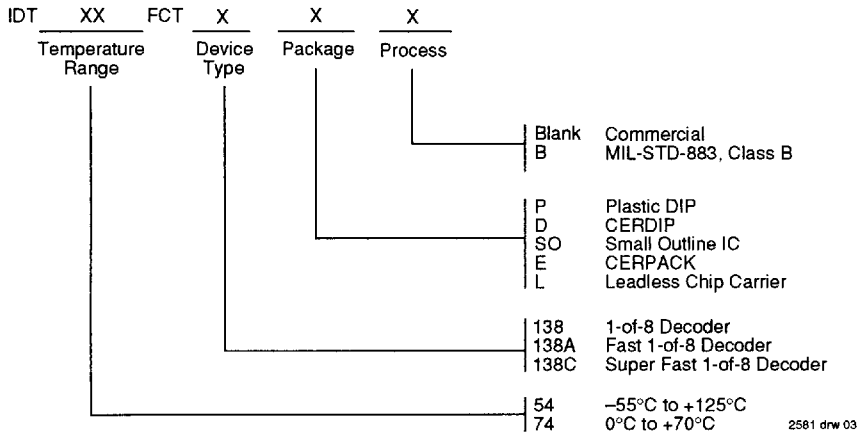

7