

Photoelectric Smoke Detector IC with I/O and Temporal Pattern Horn Driver

The CMOS MC145012 is an advanced smoke detector component containing sophisticated very-low-power analog and digital circuitry. The IC is used with an infrared photoelectric chamber. Detection is accomplished by sensing scattered light from minute smoke particles or other aerosols. When detection occurs, a pulsating alarm is sounded via on-chip push-pull drivers and an external piezoelectric transducer.

The variable-gain photo amplifier allows direct interface to IR detectors (photodiodes). Two external capacitors, C1 and C2, C1 being the larger, determine the gain settings. Low gain is selected by the IC during most of the standby state. Medium gain is selected during a local-smoke condition. High gain is used during push-button test. During standby, the special monitor circuit which periodically checks for degraded chamber sensitivity uses high gain also.

The I/O pin, in combination with V_{SS} , can be used to interconnect up to 40 units for common signaling. An on-chip current sink provides noise immunity when the I/O is an input. A local-smoke condition activates the short-circuit-protected I/O driver, thereby signaling remote smoke to the interconnected units. Additionally, the I/O pin can be used to activate escape lights, enable auxiliary or remote alarms, and/or initiate auto-dialers.

While in standby, the low-supply detection circuitry conducts periodic checks using a pulsed load current from the LED pin. The trip point is set using two external resistors. The supply for the MC145012 can be a 9.0 V battery.

A visible LED flash accompanying a pulsating audible alarm indicates a local-smoke condition. A pulsating audible alarm with no LED flash indicates a remote-smoke condition. A beep or chirp occurring virtually simultaneously with an LED flash indicates a low-supply condition. A beep or chirp occurring halfway between LED flashes indicates degraded chamber sensitivity. A low-supply condition does not affect the smoke detection capability if $V_{DD} \geq 6.0$ V. Therefore, the low-supply condition and degraded chamber sensitivity can be further distinguished by performing a push-button (chamber) test.

Features

- Circuit is designed to operate in smoke detector systems that comply with UL217 and UL268 Specifications
- Operating Voltage Range: 6.0 V to 12 V, Average Supply Current: 8 μ A
- Operating Temperature Range: -10 to 60°C
- I/O Pin Allows Units to be Interconnected for Common Signalling
- Power-On Reset Places IC in Standby Mode (Non-Alarm State)
- Electrostatic Discharge (ESD) and Latch Up Protection Circuitry on All Pins
- Chip Complexity: 2000 FETs, 12 NPNs, 16 Resistors, and 10 Capacitors
- Supports NFPA 72, ANSI S3.41, and ISO 8201 Audible Emergency Evacuation Signals
- Ideal for battery-powered applications
- Pb-Free Packaging Designated by Suffix Codes ED and EG

MC145012

PHOTOELECTRIC SMOKE
 DETECTOR IC WITH I/O AND
 TEMPORAL PATTERN
 HORN DRIVER

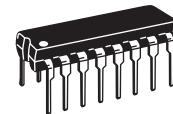

P SUFFIX
 ED SUFFIX (PB-FREE)
 PLASTIC DIP
 CASE 648-08

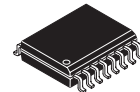

DW SUFFIX
 EG SUFFIX (PB-FREE)
 SOIC PACKAGE
 CASE 751G-04

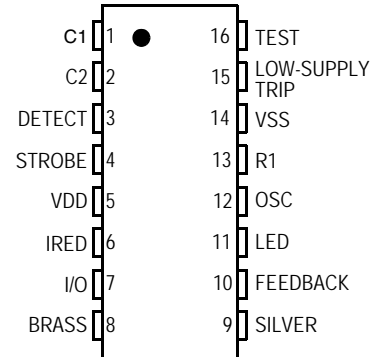

Figure 1. Pin Connections

ORDERING INFORMATION

Device	Temp. Range	Case No.	Package
MC145012P	-55 to +125°C	648-08	16 Lead Plastic Dip
MC145012ED			16 PDIP (Pb-Free)
MC145012DW		751G-04	16 Lead SOICW
MCZ145012EG/R2			16 SOICW (Pb-Free)

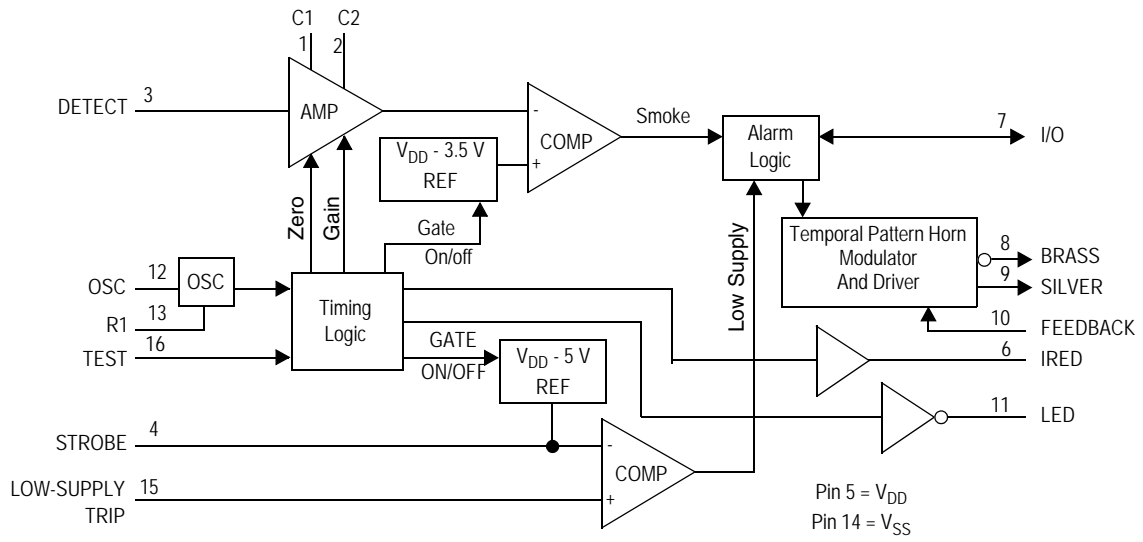

Figure 2. Block Diagram

Table 1. Maximum Ratings

All voltages are with respect to ground unless otherwise noted. Exceeding these ratings may cause a malfunction or permanent damage to the device. (Voltages referenced to V_{SS})

Rating	Symbol	Value	Unit
DC Supply Voltage	V_{DD}	-0.5 to +12	V
DC Input Voltage C1, C2, Detect Osc, Low-Supply Trip I/O Feedback Test	V_{IN}	-0.25 to $V_{DD} + 0.25$ -0.25 to $V_{DD} + 0.25$ -0.25 to $V_{DD} + 10$ -15 to +25 -1.0 to $V_{DD} + 0.25$	V
DC Input Current, per Pin	I_{IN}	± 10	mA
DC Output Current, per Pin	I_{OUT}	± 25	mA
DC Supply Current, V_{DD} and V_{SS} Pins	I_{DD}	+25 / -150	mA
Power Dissipation in Still Air 5 Seconds Continuous	P_D	1200 ⁽¹⁾ 350 ⁽²⁾	mW
Storage Temperature	T_{STG}	-55 to +125	°C
Lead Temperature, 1 mm from Case for 10 Seconds	T_L	260	°C
Peak Package Reflow Temperature During Reflow ⁽³⁾ , ⁽⁴⁾	T_{PPRT}	Note 4	°C

Note:

1. Derating: -12 mW/°C from 25° to 60°C

2. Derating: -3.5 mW/°C from 25° to 60°C.

This device contains protection circuitry to guard against damage due to high static voltages or electric fields. However, precautions must be taken to avoid applications of any voltage higher than maximum rated voltages to this high-impedance circuit. For proper operation, V_{in} and V_{out} should be constrained to the range $V_{SS} \leq (V_{in} \text{ or } V_{out}) \leq V_{DD}$ except for the I/O, which can exceed V_{DD} , and the Test input, which can go below V_{SS} .

Unused inputs must always be tied to an appropriate logic voltage level (e.g., either V_{SS} or V_{DD}). Unused outputs and/or an unused I/O must be left open.

3. Pin soldering temperature limit is for 10 seconds maximum duration. Not designed for immersion soldering. Exceeding these limits may cause malfunction or permanent damage to the device.

4. Freescale's Package Reflow capability meets Pb-free requirements for JEDEC standard J-STD-020C. For Peak Package Reflow Temperature and Moisture Sensitivity Levels (MSL),

> Go to www.freescale.com

> Search by part number [e.g. remove prefixes/suffixes and enter the core ID to view all orderable parts. (ie. MC33xxx enter 33xxx)]

> Locate your Part Number and in the Details column, select "View"

> Select "Environmental and Compliance Information"

Table 2. Electrical Characteristics(Voltages Referenced to V_{SS} , $T_A = -10$ to 60°C Unless Otherwise Indicated).

Characteristic	Symbol	Test Condition	V_{DD} V	Min	Max	Unit
Power Supply Voltage Range	V_{DD}		—	6.0	12	V
Supply Threshold Voltage, Low-Supply Alarm	V_{TH}	Low-Supply Trip: $V_{in} = V_{DD}/3$	—	6.5	7.8	V
Average Operating Supply Current (per Package) (Does Not Include Current through D3-IR Emitter)	I_{DD}	Standby Configured per Figure 8	12.0	—	8.0	μA
Peak Supply Current (per Package) (Does Not Include IRED Current into Base of Q1)	I_{DD}	During Strobe On, IRED Off Configured per Figure 8	12.0	—	2.0	mA
		During Strobe On, IRED On Configured per Figure 8	12.0	—	3.0	
Low-Level Input Voltage I/O Feedback Test	V_{IL}		9.0	—	1.5	V
			9.0	—	2.7	
			9.0	—	7.0	
High-Level Input Voltage I/O Feedback Test	V_{IH}		9.0	3.2	—	V
			9.0	6.3	—	
			9.0	8.5	—	
Input Current OSC, Detect Low-Supply Trip Feedback	I_{IN}	$V_{in} = V_{SS}$ or V_{DD} $V_{in} = V_{SS}$ or V_{DD} $V_{in} = V_{SS}$ or V_{DD}	12.0	—	± 100	nA
			12.0	—	± 100	
			12.0	—	± 100	
Low-Level Input Current Test	I_{IL}	$V_{in} = V_{SS}$	12.0	-100	-1.0	μA
Pull-Down Current Test I/O	I_{IH}	$V_{in} = V_{DD}$ No Local Smoke, $V_{in} = V_{DD}$ No Local Smoke, $V_{in} = 17\text{ V}$	9.0	0.5	10	μA
			9.0	25	100	
			12.0	—	140	
Low-Level Output Voltage LED Silver, Brass	V_{OL}	$I_{out} = 10\text{ mA}$ $I_{out} = 16\text{ mA}$	6.5	—	0.6	V
			6.5	—	1.0	
High-Level Output Voltage Silver, Brass	V_{OH}	$I_{out} = -16\text{ mA}$	6.5	5.5	—	V
Output Voltage (For Line Regulation, See Pin Descriptions)	V_{OUT}	Inactive, $I_{out} = 1\text{ }\mu\text{A}$ Active, $I_{out} = 100\text{ }\mu\text{A}$ to $500\text{ }\mu\text{A}$ (Load Regulation)	—	$V_{DD} - 0.1$	—	V
			9.0	$V_{DD} - 4.40$	$V_{DD} - 5.30$	
IRED	V_{OUT}	Inactive, $I_{out} = 1\text{ }\mu\text{A}$ Active, $I_{out} = 6\text{ mA}$ (Load Regulation)	—	—	0.1	
			9.0	2.25 ⁽⁵⁾	3.75 ⁽⁵⁾	
High-Level Output Current I/O	I_{OH}	Local Smoke, $V_{out} = 4.5\text{ V}$ Local Smoke, $V_{out} = V_{SS}$ (Short Circuit Current)	6.5	-4.0	—	mA
			12.0	—	-16	
Off-State Output Leakage Current LED	I_{OZ}	$V_{out} = V_{SS}$ or V_{DD}	12.0	—	± 1.0	μA
Common Mode Voltage Range C1, C2, Detect	V_{IC}	Local Smoke, Push-button Test, or Chamber Sensitivity Test	—	$V_{DD} - 4.0$	$V_{DD} - 2.0$	V
Smoke Comparator Reference Voltage Internal	V_{REF}	Local Smoke, Push-button Test, or Chamber Sensitivity Test	—	$V_{DD} - 3.08$	$V_{DD} - 3.92$	V

Notes

5. $T_A = 25^\circ\text{C}$ only.

Table 3. AC Electrical Characteristics(Reference Timing Diagram [Figure 6](#) and [Figure 7](#))(T_A = 25°C, V_{DD} = 9.0 V, Component Values from [Figure 8](#): R1 = 100.0 KΩ, C3 = 1500.0 pF, R2 = 7.5 MΩ).

No.	Parameter	Symbol	Test Condition	Clocks	Min ⁽⁶⁾	Typ ⁽⁷⁾	Max ⁽⁶⁾	Unit
1	Oscillator Period	1/F _{OSC}	Free-Running Sawtooth Measured at Pin 12	1.0	7.0	7.9	8.6	ms
2	LED Pulse Period	T _{LED}	No Local Smoke, and No Remote Smoke	4096	28.8	32.4	35.2	s
3			Remote Smoke, but No Local Smoke	—	Extinguished			
4			Local Smoke	64	0.45	—	—	
5			Push-button Test	64	0.45	—	—	
6	LED Pulse Width and Strobe Pulse Width	T _{W(LED)} , T _{W(STB)}		1.0	7.0	—	8.6	ms
7	IREC Pulse Period	T _{IREC}	Smoke Test	1024	7.2	8.1	8.8	s
8	IREC Pulse Period	T _{IREC}	Chamber Sensitivity Test, without Local Smoke	4096	28.8	32.4	35.2	s
9			Push-button Test	128	0.9	1.0	1.1	
10	IREC Pulse Width	T _{W(IREC)}		T _F *	94	—	116	μs
11	IREC Rise Time	T _R		—	—	—	30	
12	IREC Fall Time	T _F		—	—	—	200	μs
13	Silver and Brass Temporal Modulation Pulse Width	T _{ON}		64	0.45	0.5	0.55	s
14		T _{OFF}			0.45	0.5	0.55	
15		T _{OFFD}		192	1.35	1.52	1.65	
16	Silver and Brass Chirp Pulse Period	T _{CH}	Low Supply or Degraded Chamber Sensitivity	4096	28.8	32.4	35.2	s
17	Silver and Brass Chirp Pulse Width	T _{WCH}		1	7.0	7.9	8.6	ms
18	Rising Edge on I/O to Smoke Alarm Response Time	T _{RR}	Remote Smoke, No Local Smoke	—	—	2.0 ⁽⁸⁾	—	s
19	Strobe Out Pulse Period	T _{STB}	Smoke Test	1024	7.2	8.1	8.8	s
20			Chamber Sensitivity Test, without Local Smoke	4096	28.8	32.4	35.2	
21			Low Supply Test, without Local Smoke	4096	28.8	32.4	35.2	
22			Push-button Test	—	—	1.0	—	

Notes

- Oscillator period T (= T_r + T_f) is determined by the external components R1, R2, and C3 where T_R = (0.6931) R₂ C₃ and T_F = (0.6931) R₁ * C₃. The other timing characteristics are some multiple of the oscillator timing as shown in the table. The timing shown should accommodate the NFPA 72, ANSI S3.41, and ISO 8201 audible emergency evacuation signals.
- Typicals are not guaranteed.
- Time is typical - depends on what point in cycle signal is applied.

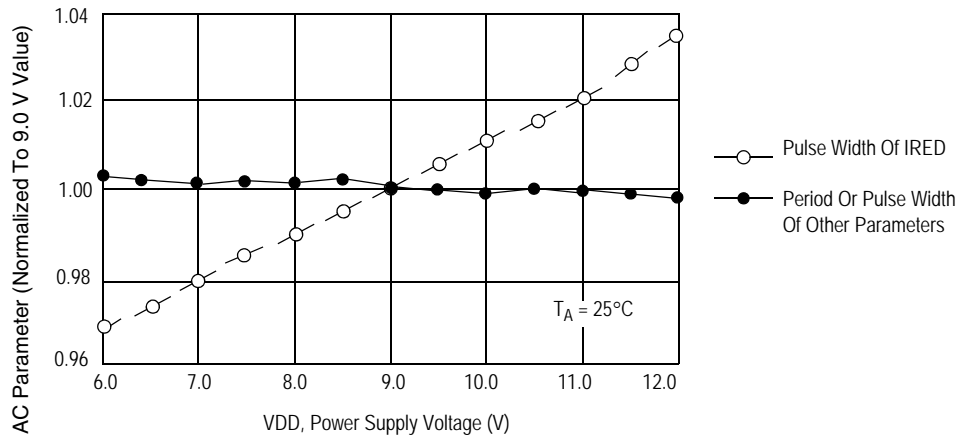

Figure 3. AC Characteristics versus Supply

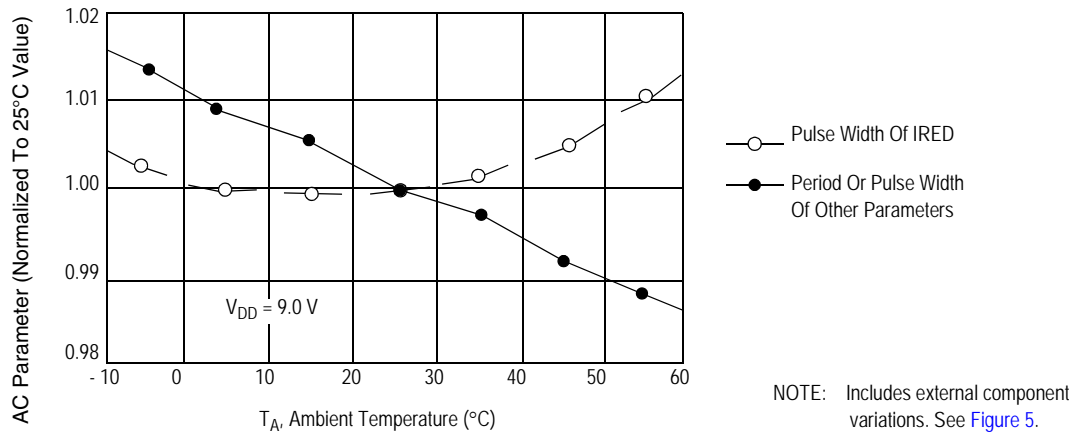

Figure 4. AC Characteristics versus Temperature

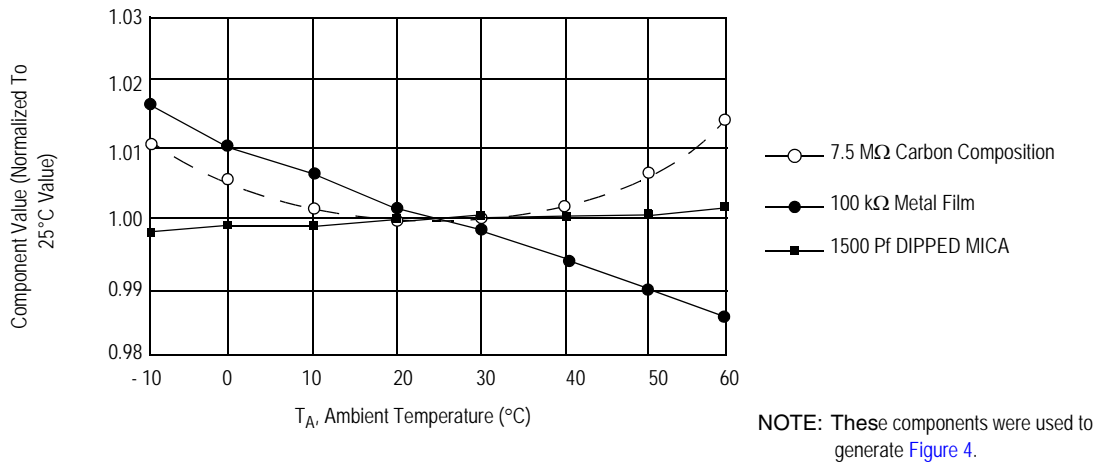
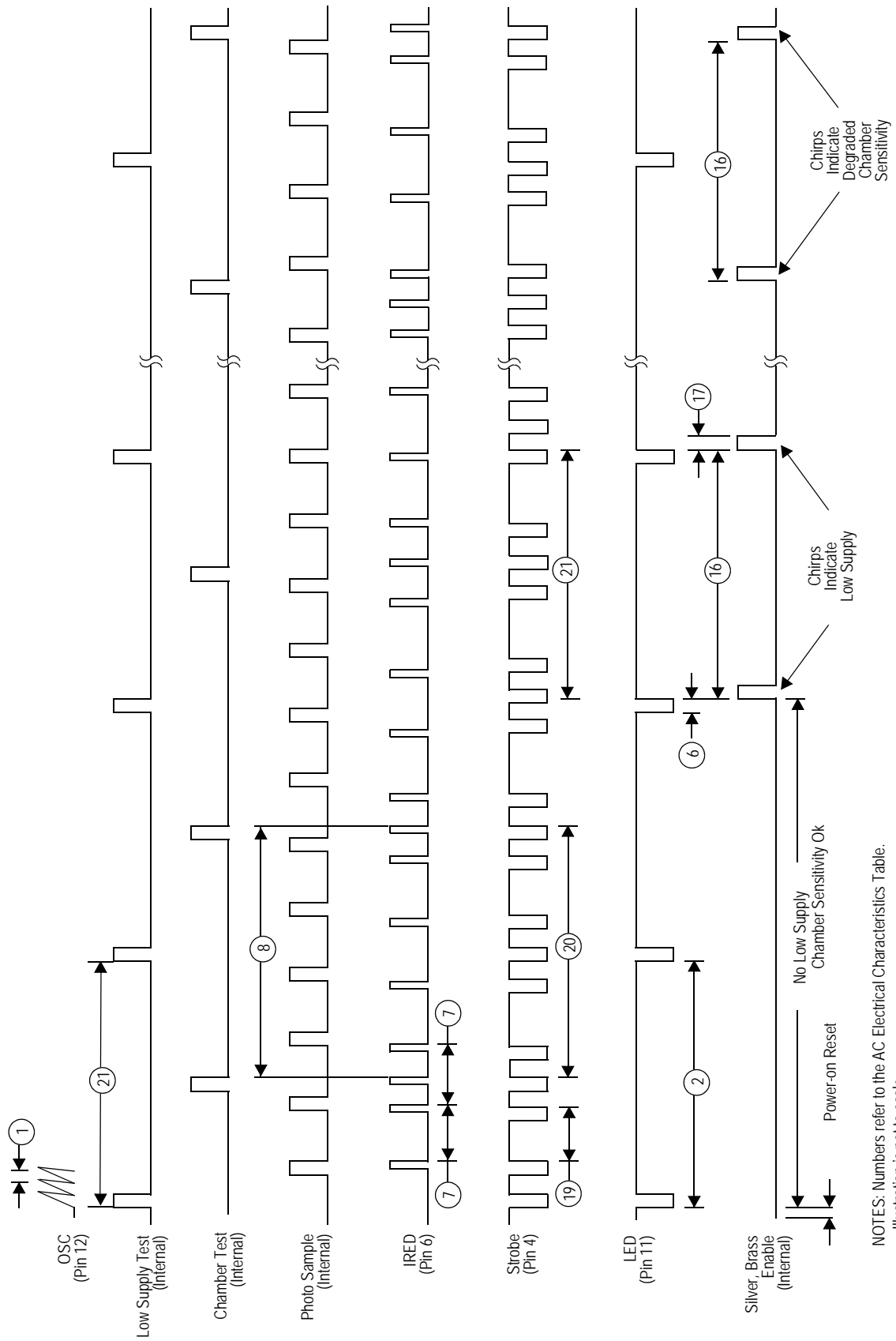
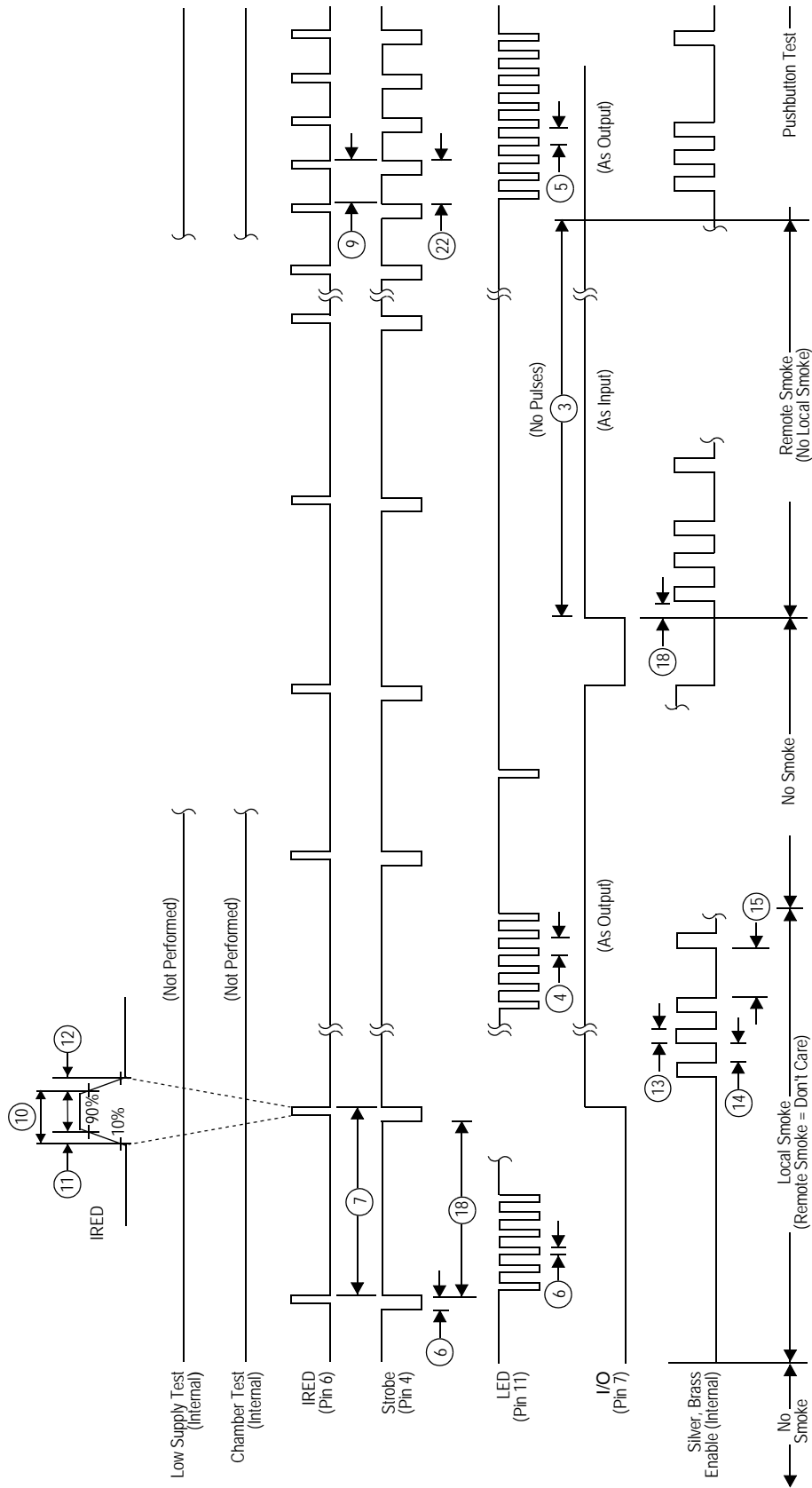

Figure 5. RC Component Variation Over Temperature



NOTES: Numbers refer to the AC Electrical Characteristics Table. Illustration is not to scale.

Figure 6. Typical Standby Timing



NOTES: Numbers refer to the AC Electrical Characteristics Table. Illustration is not to scale.

Figure 7. Typical Local Smoke Timing

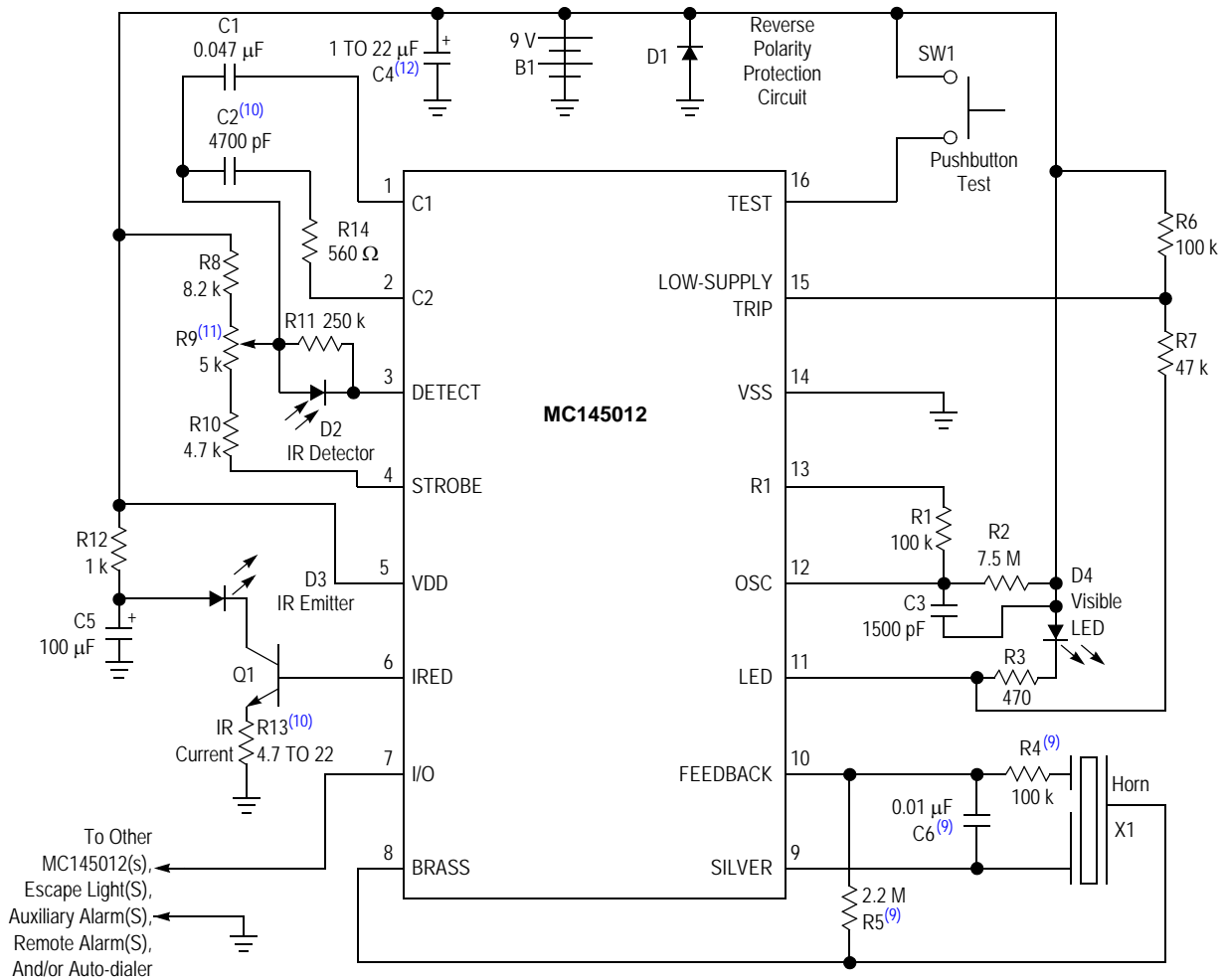

9. Values for R4, R5, and C6 may differ depending on type of piezoelectric horn used.
10. C2 and R13 are used for coarse sensitivity adjustment. Typical values are shown.
11. R9 is for fine sensitivity adjustment (optional). If fixed resistors are used, R8 = 12 k, R10 is 5.6 k to 10 k, and R9 is eliminated. When R9 is used, noise pickup is increased due to antenna effects. Shielding may be required.
12. C4 should be 22 μ F if B1 is a carbon battery. C4 could be reduced to 1 μ F when an alkaline battery is used.

Figure 8. Typical Battery-Powered Application

Table 4. Pin Description

Pin No.	Pin Name	Description
1	C1	A capacitor connected to this pin as shown in Figure 8 determines the gain of the on-chip photo amplifier during push-button test and chamber sensitivity test (high gain). The capacitor value is chosen such that the alarm is tripped from background reflections in the chamber during push-button test. $A_v \approx 1 + (C1/10)$ where C1 is in pF. CAUTION: The value of the closed-loop gain should not exceed 10,000.
2	C2	A capacitor connected to this pin as shown in Figure 8 determines the gain of the on-chip photo amplifier except during push-button or chamber sensitivity tests. $A_v \approx 1 + (C2/10)$ where C2 is in pF. This gain increases about 10% during the IRED pulse, after two consecutive local smoke detections. Resistor R14 must be installed in series with C2. $R14 \approx [1/(12\sqrt{C2})] - 680$ where R14 is in ohms and C2 is in farads.
3	DETECT	This input to the high-gain pulse amplifier is tied to the cathode of an external photodiode. The photodiode should have low capacitance and low dark leakage current. The diode must be shunted by a load resistor and is operated at zero bias. The Detect input must be AC/DC decoupled from all other signals, V_{DD} , and V_{SS} . Lead length and/or foil traces to this pin must be minimized, also. See Figure 9 .

Table 4. Pin Description (Continued)

Pin No.	Pin Name	Description
4	STROBE	This output provides a strobed, regulated voltage referenced to V_{DD} . The temperature coefficient of this voltage is $\pm 0.2\%/^{\circ}\text{C}$ maximum from -10° to 60°C . The supply-voltage coefficient (line regulation) is $\pm 0.2\%/V$ maximum from 6.0 V to 12 V. Strobe is tied to external resistor string R8, R9, and R10.
5	VDD	This pin is connected to the positive supply potential and may range from + 6.0 V to + 12 V with respect to V_{SS} CAUTION: In battery-powered applications, reverse-polarity protection must be provided externally.
6	IREDD	This output provides pulsed base current for external NPN transistor Q1 used as the infrared emitter driver. Q1 must have $\beta \geq 100$. At 10 mA, the temperature coefficient of the output voltage is typically $+ 0.5\%/^{\circ}\text{C}$ from -10° to 60°C . The supply-voltage coefficient (line regulation) is $\pm 0.2\%/V$ maximum from 6.0 V to 12 V. The IREDD pulse width (active-high) is determined by external components R1 and C3. With a 100 k Ω /1500 pF combination, the nominal width is 105 μs . To minimize noise impact, IREDD is not active when the visible LED and horn outputs are active. IREDD is active near the end of strobe pulses for smoke tests, chamber sensitivity test, and push-button test.
7	I/O	This pin can be used to connect up to 40 units together in a wired-OR configuration for common signaling. V_{SS} is used as the return. An on-chip current sink minimizes noise pick up during non-smoke conditions and eliminates the need for an external pull-down resistor to complete the wired-OR. Remote units at lower supply voltages do not draw excessive current from a sending unit at a higher supply voltage. I/O can also be used to activate escape lights, auxiliary alarms, remote alarms, and/or auto-dialers. As an input, this pin feeds a positive-edge-triggered flip-flop whose output is sampled nominally every 1 second during standby (using the recommended component values). A local-smoke condition or the push-button-test mode forces this current-limited output to source current. All input signals are ignored when I/O is sourcing current. I/O is disabled by the on-chip power-on reset to eliminate nuisance signaling during battery changes or system power-up. If unused, I/O must be left unconnected.
8	BRASS	This half of the push-pull driver output is connected to the metal support electrode of a piezoelectric audio transducer and to the horn-starting resistor. A continuous modulated tone from the transducer is a smoke alarm indicating either local or remote smoke. A short beep or chirp is a trouble alarm indicating a low supply or degraded chamber sensitivity.
9	SILVER	This half of the push-pull driver output is connected to the metal support electrode of a piezoelectric audio transducer and to the horn-starting resistor. A continuous modulated tone from the transducer is a smoke alarm indicating either local or remote smoke. A short beep or chirp is a trouble alarm indicating a low supply or degraded chamber sensitivity.
10	FEEDBACK	This input is connected to both the feedback electrode of a self-resonating piezoelectric transducer and the horn-starting resistor and capacitor through current-limiting resistor R4. If unused, this pin must be tied to V_{SS} or V_{DD} .
11	LED	This active-low open-drain output directly drives an external visible LED at the pulse rates indicated below. The pulse width is equal to the OSC period. The load for the low-supply test is applied by this output. This low-supply test is non-coincident with the smoke tests, chamber sensitivity test, push-button test, or any alarm signals. The LED also provides a visual indication of the detector status as follows, assuming the component values shown in Figure 8 : Standby (includes low-supply and chamber sensitivity tests) — Pulses every 32.4 seconds (typical) Standby (includes low-supply and chamber sensitivity tests) — Pulses every 32.4 seconds (typical) Local Smoke — Pulses every 0.51 seconds (typical) Remote Smoke — No pulses Push-button Test — Pulses every 0.51 seconds (typical)
12	OSC	This pin is used in conjunction with external resistor R2 (7.5 M Ω) to V_{DD} and external capacitor C3 (1500 pF) to V_{DD} to form an oscillator with a nominal period of 7.9 ms (typical).
13	R1	This pin is used in conjunction with resistor R1 (100 k Ω) to Pin 12 and C3 (1500 pF, see Pin 12 description) to determine the IREDD pulse width. With this RC combination, the nominal pulse width is 105 μs .
14	VSS	This pin is the negative supply potential and the return for the I/O pin. Pin 14 is usually tied to ground.
15	LOW-SUPPLY TRIP	This pin is connected to an external voltage which determines the low-supply alarm threshold. The trip voltage is obtained through a resistor divider connected between the V_{DD} and LED pins. The low-supply alarm threshold voltage (in volts) $\approx (5R7/R6) + 5$ where R6 and R7 are in the same units.
16	TEST	This input has an on-chip pull-down device and is used to manually invoke a test mode. The <i>Push-button Test</i> mode is initiated by a high level at Pin 16 (usually depression of a S.P.S.T. normally-open push-button switch to V_{DD}). After one oscillator cycle, IREDD pulses approximately every 1.0 second, regardless of the presence of smoke. Additionally, the amplifier gain is increased by automatic selection of C1. Therefore, the background reflections in the smoke chamber may be interpreted as smoke, generating a simulated-smoke condition. After the second IREDD pulse, a successful test activates the horn-driver and I/O circuits. The active I/O allows remote signaling for system testing. When the Push-button Test switch is released, the Test input returns to V_{SS} due to the on-chip pull-down device. After one oscillator cycle, the amplifier gain returns to normal, thereby removing the simulated-smoke condition. After two additional IREDD pulses, less than three seconds, the IC exits the alarm mode and returns to standby timing.

CALIBRATION

To facilitate checking the sensitivity and calibrating smoke detectors, the MC145012 can be placed in a calibration mode. In this mode, certain device pins are controlled/reconfigured as shown in Table 5. To place the part in the calibration mode, Pin 16 (Test) must be pulled below the V_{SS}

pin with 100 μ A continuously drawn out of the pin for at least one cycle on the OSC pin. To exit this mode, the Test pin is floated for at least one OSC cycle.

In the calibration mode, the IRED pulse rate is increased to one for every OSC cycle. Also, Strobe is always active low.

Table 5. Configuration of Pins in the Calibration Mode

Description	Pin	Comment
I/O	7	Disabled as an output. Forcing this pin high places the photo amp output on Pin 1 or 2, as determined by Low-Supply Trip. The amp's output appears as pulses and is referenced to V_{DD} etc.
Low-Supply Trip	15	If the I/O pin is high, Pin 15 controls which gain capacitor is used. Low: normal gain, amp output on Pin 1. High: supervisory gain, amp output on Pin 2.
Feedback	10	Driving this input high enables hysteresis (10% gain increase) in the photo amp; Pin 15 must be low.
OSC	12	Driving this input high brings the internal clock high. Driving the input low brings the internal clock low. If desired, the RC network for the oscillator may be left intact; this allows the oscillator to run similar to the normal mode of operation.
Silver	9	This pin becomes the smoke comparator output. When the OSC pin is toggling, positive pulses indicate that smoke has been detected. A static low level indicates no smoke.
Brass	8	This pin becomes the smoke integrator output. That is, 2 consecutive smoke detections are required for "on" (static high level) and 2 consecutive no-detections for "off" (static low level).

Do Not Run Any
Additional Traces
In This Region

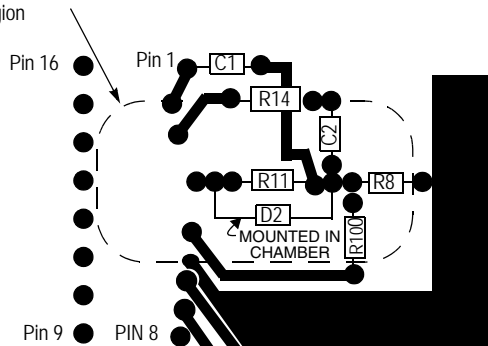

NOTES: Illustration is bottom view of layout using a DIP. Top view for SOIC layout is mirror image.

Optional potentiometer R9 is not included.

Drawing is not to scale.

Leads on D2, R11, R8, and R10 and their associated traces must be kept as short as possible. This practice minimizes noise pick up.

Pin 3 must be decoupled from all other traces.

Figure 9. Recommended PCB Layout

PACKAGE DIMENSIONS

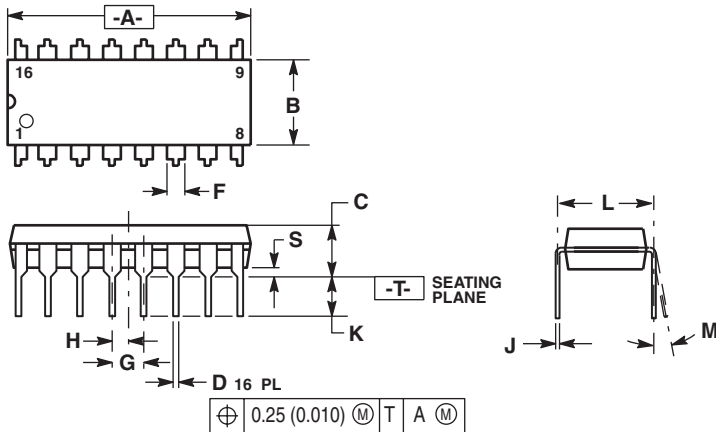

NOTES:

1. DIMENSIONING AND TOLERANCING PER ANSI Y14.5M, 1982.
2. CONTROLLING DIMENSION: INCH.
3. DIMENSION L TO CENTER OF LEADS WHEN FORMED PARALLEL.
4. DIMENSION B DOES NOT INCLUDE MOLD FLASH.
5. ROUNDED CORNERS OPTIONAL.

DIM	INCHES		MILLIMETERS	
	MIN	MAX	MIN	MAX
A	0.740	0.770	18.80	19.55
B	0.250	0.270	6.35	6.85
C	0.145	0.175	3.69	4.44
D	0.015	0.021	0.39	0.53
F	0.040	0.70	1.02	1.77
G	0.100 BSC		2.54 BSC	
H	0.050 BSC		1.27 BSC	
J	0.008	0.015	0.21	0.38
K	0.110	0.130	2.80	3.30
L	0.295	0.305	7.50	7.74
M	0	10	0	10
S	0.020	0.040	0.51	1.01

STYLE 1:

- PIN 1: CATHODE
 2. CATHODE
 3. CATHODE
 4. CATHODE
 5. CATHODE
 6. CATHODE
 7. CATHODE
 8. CATHODE
 9. ANODE
 10. ANODE
 11. ANODE
 12. ANODE
 13. ANODE
 14. ANODE
 15. ANODE
 16. ANODE

STYLE 2:

- PIN 1: COMMON DRAIN
 2. COMMON DRAIN
 3. COMMON DRAIN
 4. COMMON DRAIN
 5. COMMON DRAIN
 6. COMMON DRAIN
 7. COMMON DRAIN
 8. COMMON DRAIN
 9. GATE
 10. SOURCE
 11. GATE
 12. SOURCE
 13. GATE
 14. SOURCE
 15. GATE
 16. SOURCE

CASE 648-08 ISSUE R 16-LEAD PLASTIC DIP

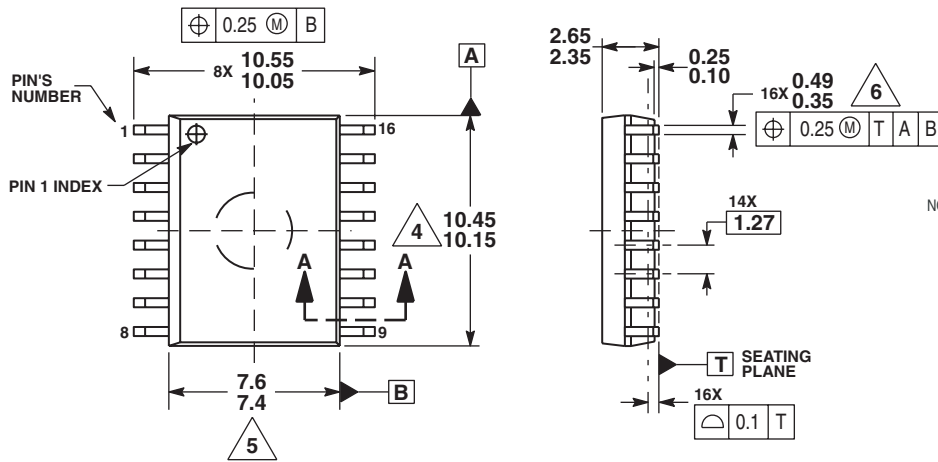

NOTES:

1. DIMENSIONS ARE IN MILLIMETERS.
2. DIMENSIONING AND TOLERANCING PER ASME Y14.5M, 1994.
3. DATUMS A AND B TO BE DETERMINED AT THE PLANE WHERE THE BOTTOM OF THE LEADS EXIT THE PLASTIC BODY.
4. THIS DIMENSION DOES NOT INCLUDE MOLD FLASH, PROTRUSION OR GATE BURRS. MOLD FLASH, PROTRUSION OR GATE BURRS SHALL NOT EXCEED 0.15mm PER SIDE. THIS DIMENSION IS DETERMINED AT THE PLANE WHERE THE BOTTOM OF THE LEADS EXIT THE PLASTIC BODY.
5. THIS DIMENSION DOES NOT INCLUDE INTER-LEAD FLASH OR PROTRUSIONS. INTER-LEAD FLASH AND PROTRUSIONS SHALL NOT EXCEED 0.25mm PER SIDE. THIS DIMENSION IS DETERMINED AT THE PLANE WHERE THE BOTTOM OF THE LEADS EXIT THE PLASTIC BODY.
6. THIS DIMENSION DOES NOT INCLUDE DAMBAR PROTRUSION. ALLOWABLE DAMBAR PROTRUSION SHALL NOT CAUSE THE LEAD WIDTH TO EXCEED 0.62mm.

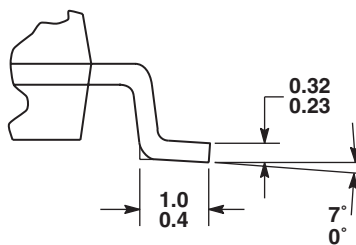
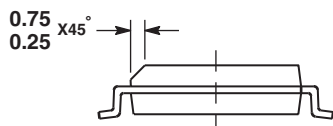

SECTION A-A

CASE 751G-04 ISSUE D 16-LEAD SOIC

REVISION HISTORY

REVISION	DATE	DESCRIPTION OF CHANGES
9.0	11/2006	<ul style="list-style-type: none">• Implemented Revision History page• Updated to the current Freescale format and style• Removed Peak Package Reflow Temperature During Reflow (solder reflow) parameter from Maximum Ratings on page 3. Added note with instructions from www.freescale.com.

How to Reach Us:

Home Page:

www.freescale.com

E-mail:

support@freescale.com

USA/Europe or Locations Not Listed:

Freescale Semiconductor
Technical Information Center, CH370
1300 N. Alma School Road
Chandler, Arizona 85224
+1-800-521-6274 or +1-480-768-2130
support@freescale.com

Europe, Middle East, and Africa:

Freescale Halbleiter Deutschland GmbH
Technical Information Center
Schatzbogen 7
81829 Muenchen, Germany
+44 1296 380 456 (English)
+46 8 52200080 (English)
+49 89 92103 559 (German)
+33 1 69 35 48 48 (French)
support@freescale.com

Japan:

Freescale Semiconductor Japan Ltd.
Headquarters
ARCO Tower 15F
1-8-1, Shimo-Meguro, Meguro-ku,
Tokyo 153-0064
Japan
0120 191014 or +81 3 5437 9125
support.japan@freescale.com

Asia/Pacific:

Freescale Semiconductor Hong Kong Ltd.
Technical Information Center
2 Dai King Street
Tai Po Industrial Estate
Tai Po, N.T., Hong Kong
+800 2666 8080
support.asia@freescale.com

For Literature Requests Only:

Freescale Semiconductor Literature Distribution Center
P.O. Box 5405
Denver, Colorado 80217
1-800-441-2447 or 303-675-2140
Fax: 303-675-2150
LDCForFreescaleSemiconductor@hibbertgroup.com

RoHS-compliant and/or Pb-free versions of Freescale products have the functionality and electrical characteristics of their non-RoHS-compliant and/or non-Pb-free counterparts. For further information, see <http://www.freescale.com> or contact your Freescale sales representative.

For information on Freescale's Environmental Products program, go to <http://www.freescale.com/epp>.

Information in this document is provided solely to enable system and software implementers to use Freescale Semiconductor products. There are no express or implied copyright licenses granted hereunder to design or fabricate any integrated circuits or integrated circuits based on the information in this document.

Freescale Semiconductor reserves the right to make changes without further notice to any products herein. Freescale Semiconductor makes no warranty, representation or guarantee regarding the suitability of its products for any particular purpose, nor does Freescale Semiconductor assume any liability arising out of the application or use of any product or circuit, and specifically disclaims any and all liability, including without limitation consequential or incidental damages. "Typical" parameters that may be provided in Freescale Semiconductor data sheets and/or specifications can and do vary in different applications and actual performance may vary over time. All operating parameters, including "Typicals", must be validated for each customer application by customer's technical experts. Freescale Semiconductor does not convey any license under its patent rights nor the rights of others. Freescale Semiconductor products are not designed, intended, or authorized for use as components in systems intended for surgical implant into the body, or other applications intended to support or sustain life, or for any other application in which the failure of the Freescale Semiconductor product could create a situation where personal injury or death may occur. Should Buyer purchase or use Freescale Semiconductor products for any such unintended or unauthorized application, Buyer shall indemnify and hold Freescale Semiconductor and its officers, employees, subsidiaries, affiliates, and distributors harmless against all claims, costs, damages, and expenses, and reasonable attorney fees arising out of, directly or indirectly, any claim of personal injury or death associated with such unintended or unauthorized use, even if such claim alleges that Freescale Semiconductor was negligent regarding the design or manufacture of the part.

Freescale™ and the Freescale logo are trademarks of Freescale Semiconductor, Inc. All other product or service names are the property of their respective owners.

© Freescale Semiconductor, Inc. 2006. All rights reserved.

