

Schnitt A-A /
cross section A-A

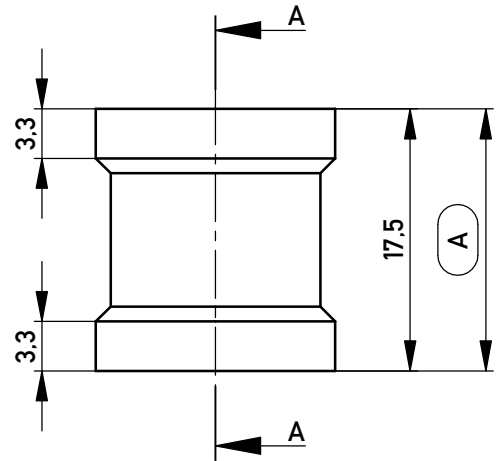

Layout - Vorschlag
PCB - Layout proposal
M 1:1
scale 1:1

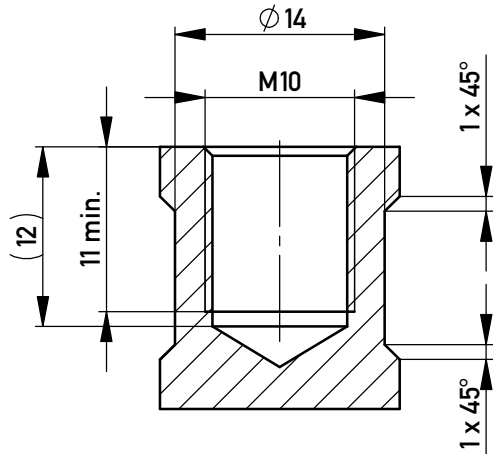

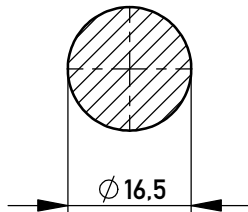

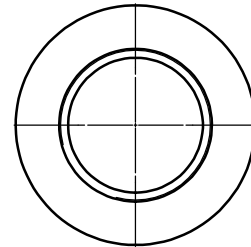
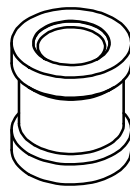
M 1:1 / scale 1:1



5-10 μ m Sn matt über 1-3 μ m Ni /
5-10 μ m sn matt over 1-3 μ m ni

Oberfläche (A) / plating (A)

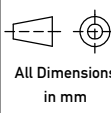
Copyright by ERNI Production GmbH & Co. KG
Proprietary notice pursuant to ISO 16016 to be observed.

Information:		Tolerances	 All Dimensions in mm	Scale	2:1
All rights reserved. Only for Information. To ensure that this is the latest version of this drawing, please contact one of the ERNI companies before using.		Subject to modification without prior notice. Drawing will not be updated.		Material:	CuZn39Pb3
		 www.ERNI.com		Designation	PowerElement SMD <i>female thread M10</i>
b	09.05.2017	<div style="text-align: center; font-size: 2em; font-weight: bold;">225861</div>			<div style="text-align: center;">I A4</div>
Index	Date				
				Class	POWELM