

SF1189B

280.00 MHz SAW Filter

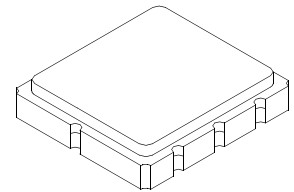

SM5050-8

- **Designed for WLAN IF Applications**
- **Low Insertion Loss**
- **5.0 x 5.0 x 1.7 mm Surface-Mount Case**
- **Single Ended or Differential Input and Output**

Absolute Maximum Ratings

Rating	Value	Units
Maximum Incident Power in Passband	+10	dBm
Max. DC voltage between any 2 terminals	0	VDC
Storage Temperature Range	-40 to +85	°C
Max Soldering Profile	265°C for 10 s	

Characteristic	Sym	Notes	Min	Typ	Max	Units
Nominal Center Frequency	f_C	1	280.0			MHz
Passband	Insertion Loss at f_C	IL		8.2	8.5	dB
		BW_3	1, 2	18.5	20.1	MHz
	3 dB Passband Amplitude Ripple over $f_C \pm 9.0$ MHz			2.0	2.5	dB _{P-P}
	Group Delay Variation over $f_C \pm 9.0$ MHz	GDV			72	100
Rejection	$f_C - 60$ to $f_C - 40$ MHz	$f_C - 40$ to $f_C - 22$ MHz	1, 2, 3	40	47	dB
		$f_C - 22$ to $f_C - 17$ MHz		38	41	
		$f_C + 17$ to $f_C + 22$ MHz		30	39	
		$f_C + 22$ to $f_C + 40$ MHz		25	36	
		$f_C + 40$ to $f_C + 60$ MHz		34	36	
		$f_C + 40$ to $f_C + 60$ MHz		40	41	
Operating Temperature Range	T_A	1	-10		+85	°C

Differential Input / Output Impedance Match	External L-C
Case Style	SM5050-8 5 X 5 mm Nominal Footprint
Lid Symbolization (YY=year, WW=week, S=shift)	453, YYWWS

Electrical Connections

Connection	Terminals
Port 1 Hot	2
Port 1 Gnd or Return	1
Port 2 Hot	6
Port 2 Gnd or Return	5
Case Ground	All others

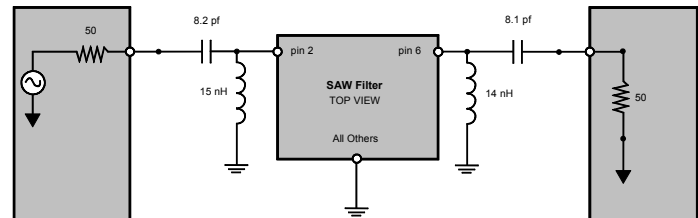

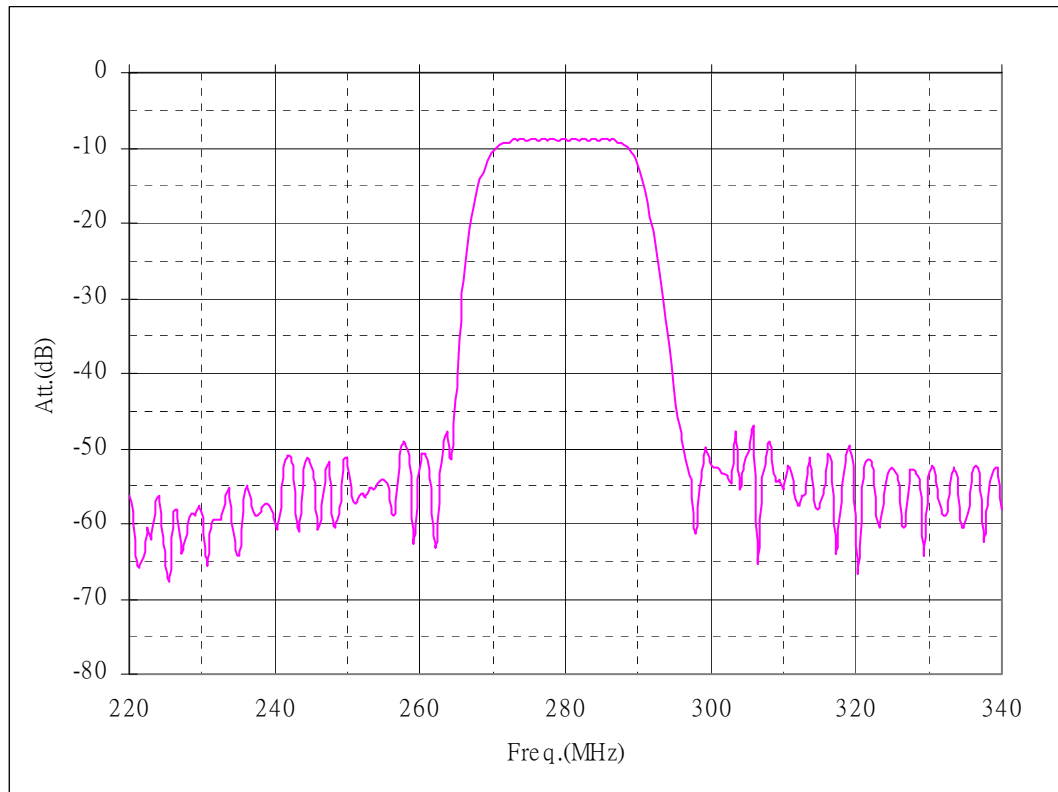
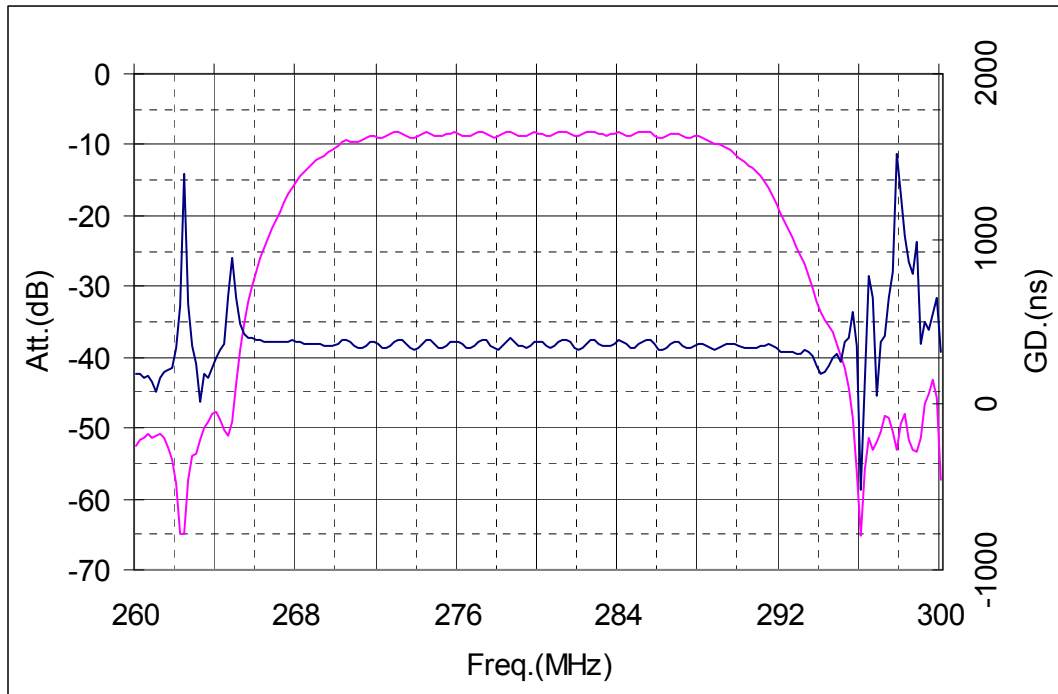

figure 1

NOTES:

1. Unless noted otherwise, all specifications apply over the operating temperature range with filter soldered to the specified demonstration board with impedance matching to 50 Ω and measured with 50 Ω network analyzer.
2. Unless noted otherwise, all frequency specifications are referenced to the nominal center frequency, f_C .
3. Rejection is measured as attenuation below the minimum IL point in the passband. Rejection in final user application is dependent on PCB layout and external impedance matching design. See Application Note No. 42 for details.
4. The design, manufacturing process, and specifications of this filter are subject to change.
5. Either Port 1 or Port 2 may be used for either input or output in the design. However, impedances and impedance matching may vary between Port 1 and Port 2, so that the filter must always be installed in one direction per the circuit design.
6. US and international patents may apply.
7. Murata, stylized Murata logo, and Murata N.A., Inc. are registered trademarks of Murata Manufacturing Co., Ltd.
8. Electrostatic Sensitive Device. Observe precautions for handling. 

Frequency Characteristics



SM5050-8 Case

8-Terminal Ceramic Surface-Mount Case 5.0 X 5.0 mm Nominal Footprint

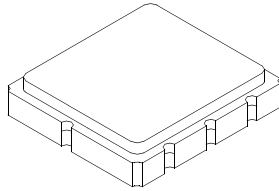

Case Dimensions

Dimension	mm			Inches		
	Min	Nom	Max	Min	Nom	Max
A	4.8	5.0	5.2		0.1968	
B	4.8	5.0	5.2		0.1968	
C			1.7			0.0669
D		2.08			0.0818	
E		1.17			0.046	
F		0.64			0.0252	
G	2.39	2.54	2.69		0.100	

Electrical Connections	Terminals
Input	2
Output	6
Ground	All others
Single Ended Operation	Return is ground
Differential Operation	Return is hot
Dot indicates Pin 1	

TOP VIEW

BOTTOM VIEW

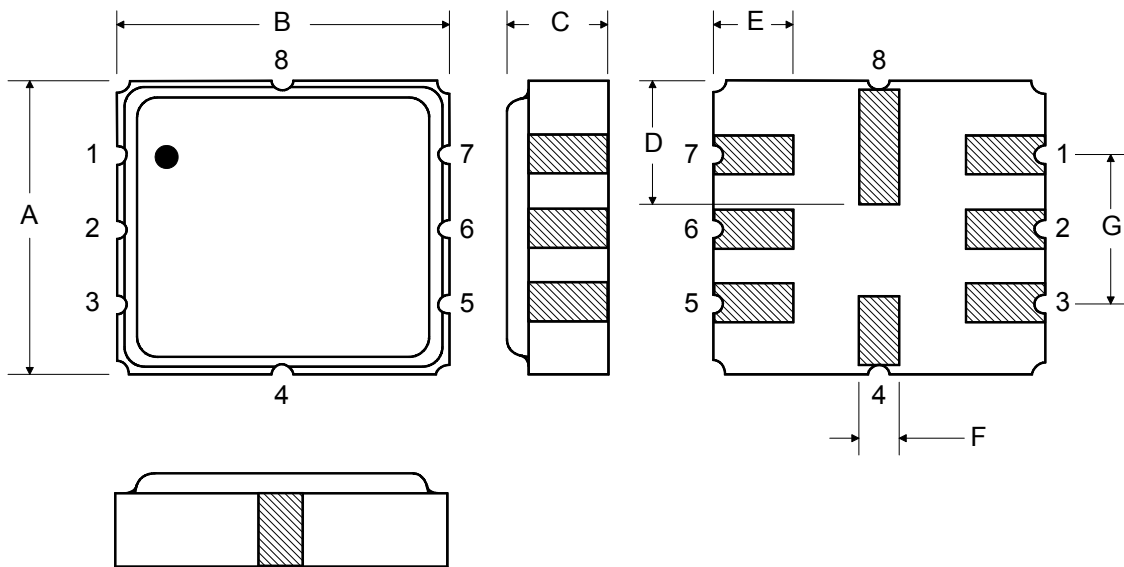

Tape and Reel Specifications

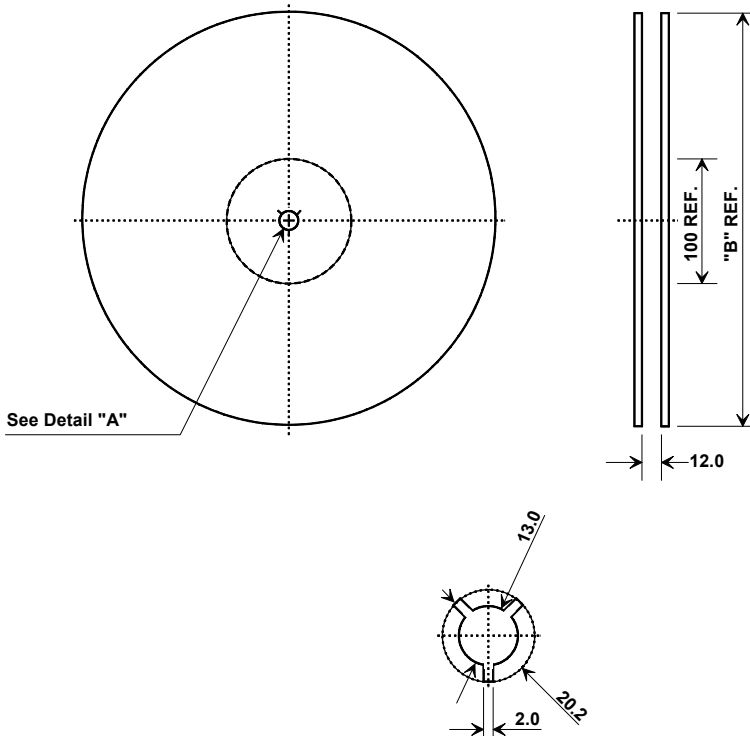

"B" Nominal Size		Quantity Per Reel
Inches	millimeters	
7	178	500
13	330	3000

COMPONENT ORIENTATION and DIMENSIONS

Carrier Tape Dimensions	
Ao	5.3 mm
Bo	5.3 mm
Ko	2.0 mm
Pitch	8.0 mm
W	12.0 mm

