



RF360  
Europe GmbH

## SAW Components

### SAW Rx filter

Automotive telematics

Series/type:	B4304
Ordering code:	B39941B4304F210
Date:	December 19, 2013
Version:	2.3

RF360 products mentioned within this document are products of RF360 Europe GmbH and other subsidiaries of RF360 Holdings Singapore Pte. Ltd. (collectively, the "RF360 Subsidiaries").

RF360 Europe GmbH, Anzinger Str. 13, München, Germany

© 2019 RF360 Europe GmbH and/or its affiliated companies. All rights reserved.

These materials, including the information contained herein, may be used only for informational purposes by the customer. The RF360 Subsidiaries assume no responsibility for errors or omissions in these materials or the information contained herein. The RF360 Subsidiaries reserve the right to make changes to the product(s) or information contained herein without notice. The materials and information are provided on an AS IS basis, and the RF360 Subsidiaries assume no liability and make no warranty or representation, either expressed or implied, with respect to the materials, or any output or results based on the use, application, or evaluation of such materials, including, without limitation, with respect to the non-infringement of trademarks, patents, copyrights or any other intellectual property rights or other rights of third parties.

No use of this documentation or any information contained herein grants any license, whether express, implied, by estoppel or otherwise, to any intellectual property rights, including, without limitation, to any patents owned by QUALCOMM Incorporated or any of its subsidiaries.

Not to be used, copied, reproduced, or modified in whole or in part, nor its contents revealed in any manner to others without the express written permission of RF360 Europe GmbH.

Qualcomm is a trademark of Qualcomm Incorporated, registered in the United States and other countries. Other product and brand names may be trademarks or registered trademarks of their respective owners.

This technical data may be subject to U.S. and international export, re-export, or transfer ("export") laws. Diversion contrary to U.S. and international law is strictly prohibited.



# SAW Components

## SAW Rx filter

Automotive telematics

<b>Series/type:</b>	<b>B4304</b>
<b>Ordering code:</b>	<b>B39941B4304F210</b>
<b>Date:</b>	<b>December 19, 2013</b>
<b>Version:</b>	<b>2.3</b>

Data sheet

**Application**

- Low-loss RF filter for WCDMA Band VIII and GSM 900 systems, receive path (RX)
- Very low insertion loss
- Useable passband: 35 MHz
- Unbalanced to balanced operation
- Impedance transformation from 50 Ω to 150 Ω
- Suitable for GPRS class 1 to 12

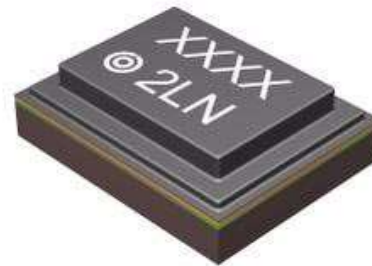
**Features**

- Package size 1.4 x 1.1 x 0.4 mm<sup>3</sup>
- Package code QCS5M
- RoHS compatible
- Approximate weight 0.003 g
- Package for **Surface Mount Technology (SMT)**
- Ni, gold-plated terminals
- AEC-Q200 qualified component family (operable temperature range -40°C to +85°C)
- **Electrostatic Sensitive Device (ESD)**

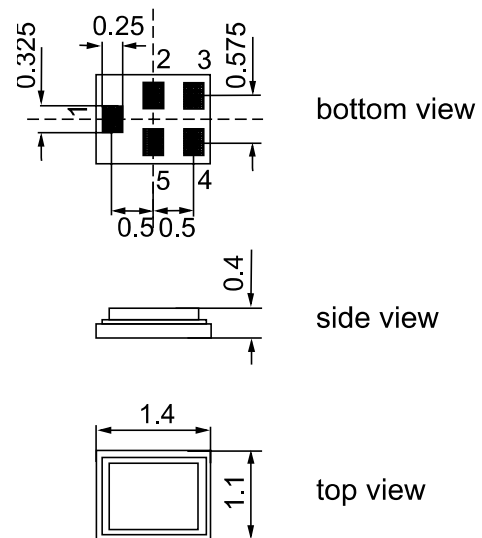
**Pin configuration**

- 1 Input
- 3,4 Output, balanced
- 2,5 To be grounded

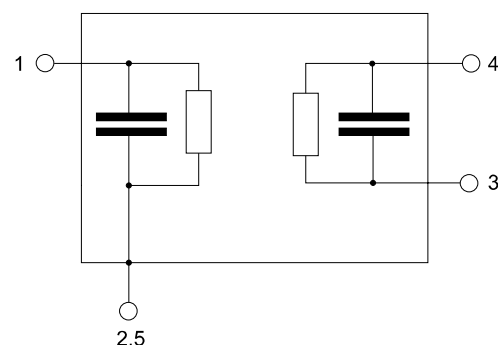

**Data sheet**

**Characteristics**

Temperature range for specification:  $T = -20\text{ °C to }+75\text{ °C}$   
 Terminating source impedance:  $Z_S = 50\ \Omega$  (unbalanced)  
 Terminating load impedance:  $Z_L = 150\ \Omega \parallel 100\text{ nH}$  (balanced)

		min.	typ. @ 25 °C	max.		
<b>Center frequency</b>		$f_C$	—	942.5	—	MHz
<b>Maximum insertion attenuation</b>						
	925.0 ... 960.0 MHz	$\alpha_{\text{GSM}}$	—	1.5	2.7	dB
@ $f_{\text{Carrier Bd 8 RX}}$	927.4 ... 957.6 MHz	$\alpha_{\text{WCDMA}}^{1)}$	—	1.5	2.0	dB
<b>Amplitude ripple (p-p)</b>						
	925.0 ... 960.0 MHz	$\Delta\alpha$	—	0.9	2.1	dB
<b>Error Vector Magnitude<sup>2)</sup></b>						
@ $f_{\text{Carrier Bd 8 RX}}$	927.4 ... 957.6 MHz	EVM	—	3.0	4.5	%
<b>VSWR</b>						
Input	925.0 ... 960.0 MHz		—	1.9	2.2	
Output	925.0 ... 960.0 MHz		—	1.9	2.2	
<b>CMRR (<math> S_{21}-S_{31}  /  S_{21}+S_{31} </math>)</b>						
	925.0 ... 960.0 MHz		20 <sup>3)</sup>	25	—	dB
<b>Attenuation</b>		$\alpha$				
	DC ... 480.0 MHz		45	53	—	dB
	480.0 ... 835.0 MHz		33	46	—	dB
	835.0 ... 880.0 MHz		30	34	—	dB
@ $f_{\text{Carrier Bd 8 TX}}$	882.4 ... 912.6 MHz	$\alpha_{\text{WCDMA}}^{1)}$	30	34	—	dB
	880.0 ... 915.0 MHz	$\alpha_{\text{GSM}}$	30	33	—	dB
	915.0 ... 922.0 MHz		1.0	2.5	—	dB
	980.0 ... 982.0 MHz		20	30	—	dB
	982.0 ... 1000.0 MHz		23	30	—	dB
	1850.0 ... 1920.0 MHz		40	47	—	dB
	2775.0 ... 2880.0 MHz		36	41	—	dB
	3700.0 ... 3840.0 MHz		38	50	—	dB
	1000.0 ... 1500.0 MHz		23	32	—	dB
	1500.0 ... 6000.0 MHz		23	34	—	dB

1) Attenuation of WCDMA signal ("Powertransferfunction"). Please refer to annotation on page (4).

2) Error Vector Magnitude (EVM) based on definition given in 3GPP TS 25.141.

3) A CMRR of 19.6 dB corresponds to a phase imbalance of  $\pm 10^\circ$  together with an amplitude imbalance of  $\pm 1.0$  dB

**Annotation for characteristics section**

Attenuation of WCDMA signal ("Powertransferfunction",  $\alpha_{\text{WCDMA}}$ ) is determined by

$$\int_{-\infty}^{\infty} |S_{\text{ds21}}(f)H_{\text{RRC}}(f - f_{\text{Carrier}})|^2 df$$

$f_{\text{Carrier}}$  according to 3GPP TS 25.101 (e.g. for band VIII RX passband,  $f_{\text{Carrier}}$  ranges from 927.4 MHz (lowest RX channel) to 957.6 MHz (highest RX channel)).  $H_{\text{RRC}}(f)$  is the transfer function of the root-raised cosine transmit pulse shaping filter according to 3GPP TS 25.101 with the following normalization:

$$\int_{-\infty}^{\infty} |H_{\text{RRC}}(f)|^2 df = 1$$

**Maximum ratings**

Operable temperature range	T	-40/+85	°C	
Storage temperature range	T <sub>stg</sub>	-40/+85	°C	
DC voltage	V <sub>DC</sub>	0	V	
ESD voltage	V <sub>ESD</sub>	100 <sup>1)</sup>	V	machine model, 10 pulses
Input power	P <sub>IN</sub>	13	dBm	
Input power at				
GSM850, GSM900	P <sub>IN</sub>	15	dBm	effective power in the on-state, duty cycle 4:8
GSM1800, GSM1900	P <sub>IN</sub>	15	dBm	
Tx bands				

<sup>1)</sup> acc. to JESD22-A115A (machine model), 10 negative & 10 positive pulses.

Data sheet

**ESD protection of SAW filters**

SAW filters are **E**lectro **S**tatic **D**ischarge sensitive devices. To reduce the probability of damages caused by ESD, special matching topologies have to be applied.

In general, “ESD matching” has to be ensured at that filter port, where electrostatic discharge is expected.

Electrostatic discharges predominantly appear at the antenna input of RF receivers. Therefore only the input matching of the SAW filter has to be designed to short circuit or to block the ESD pulse.

Below three figures show recommended “ESD matching” topologies.

For wideband filters the high-pass ESD matching structure needs to be at least of 3<sup>rd</sup> order to ensure a proper matching for any impedance value of antenna and SAW filter input. The required component values have to be determined from case to case.

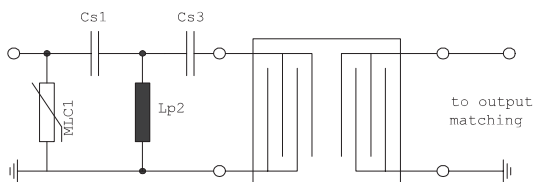
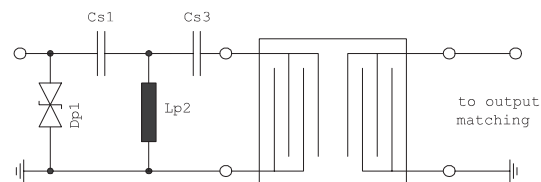
**Fig. 1 MLC varistor plus ESD matching**

**Fig. 2 Suppressor diode plus ESD matching**

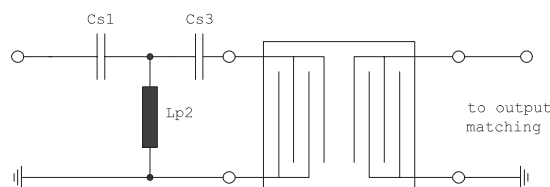
In cases where minor ESD occur, following simplified “ESD matching” topologies can be used alternatively.

**Fig. 3 3<sup>rd</sup> order high-pass structure for basic ESD protection**

In all three figures the shunt inductor Lp2 could be replaced by a shorted microstrip with proper length and width. If this configuration is possible depends on the operating frequency and available pcb space.

Effectiveness of the applied ESD protection has to be checked according to relevant industry standards or customer specific requirements

For further information, please refer to EPCOS Application report:

**“ESD protection for SAW filters”**.

This report can be found under [www.epcos.com/rke](http://www.epcos.com/rke). Click on “Applications Notes”.

Data sheet



**Transfer function**

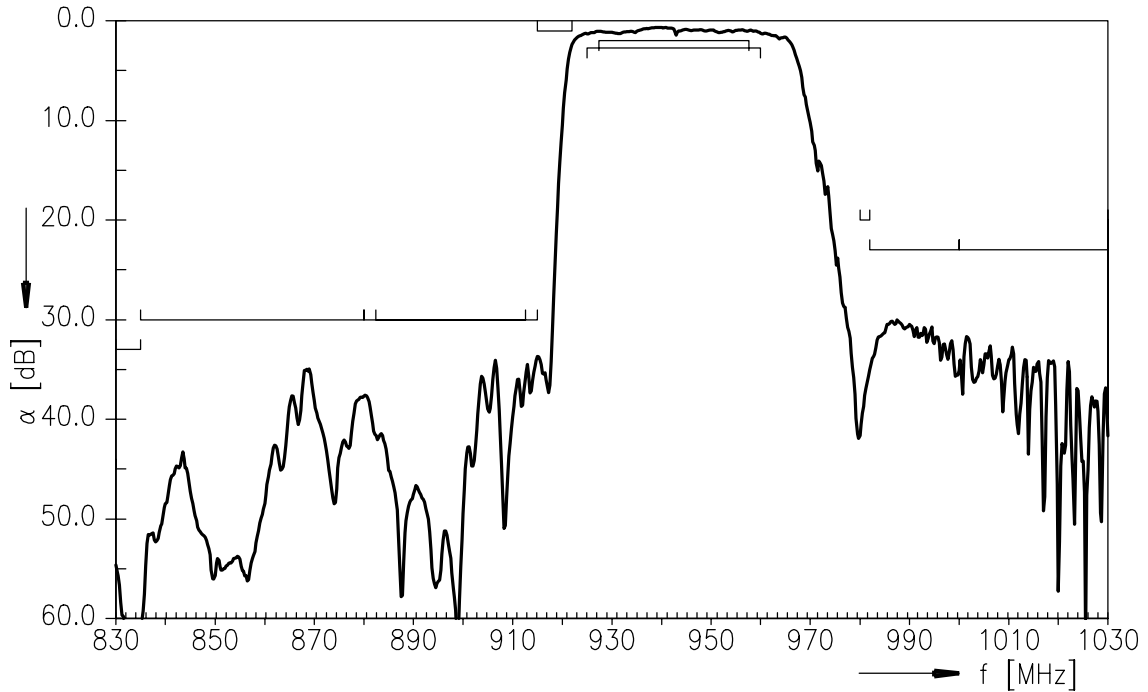

**Transfer function (wideband)**

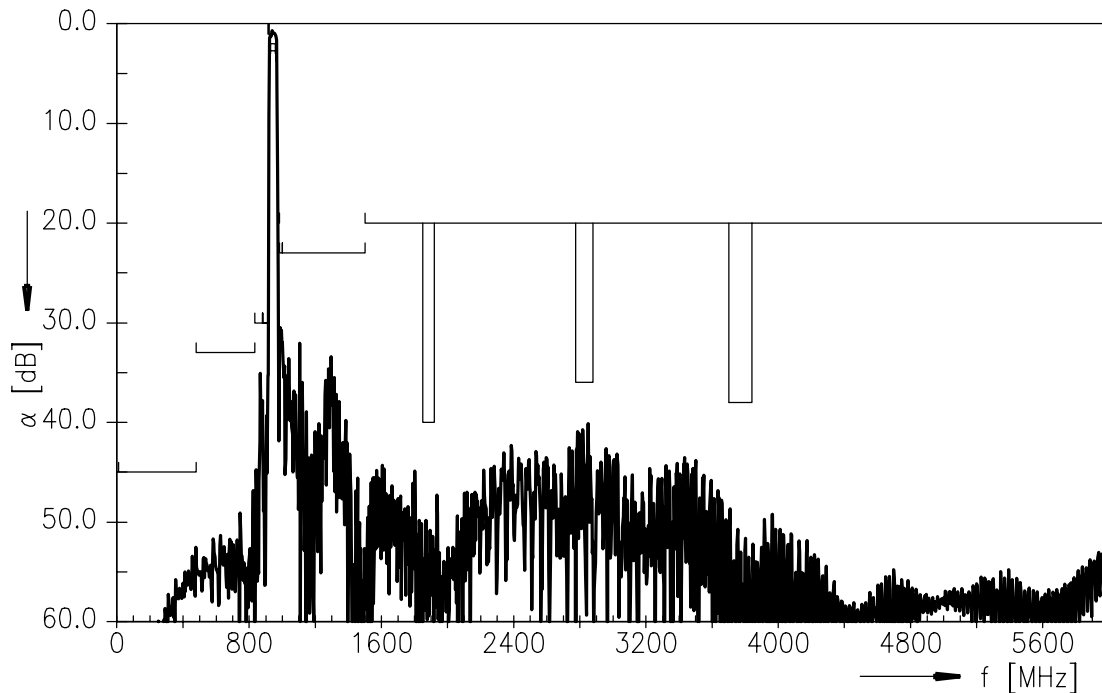



Data sheet



Smith chart

**S<sub>11</sub> function**

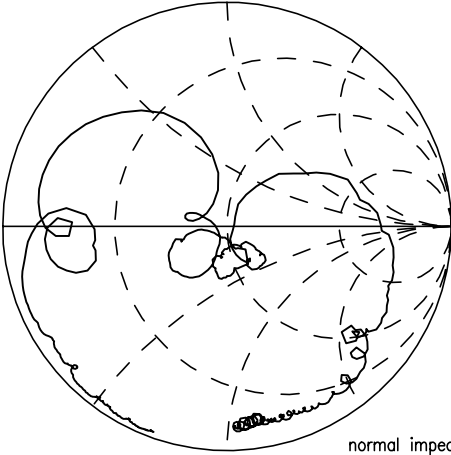

normal impedance: 50.00 Ω

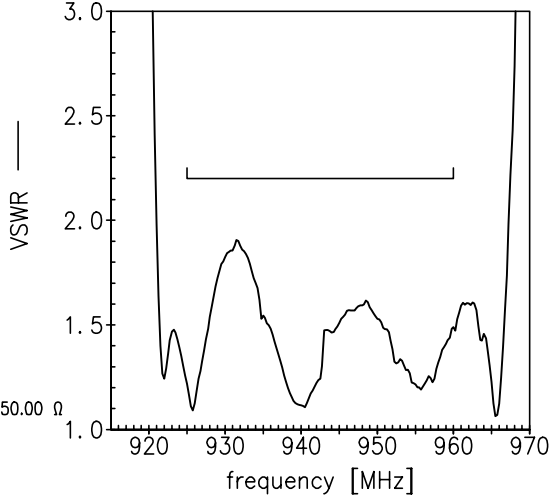

**S<sub>22</sub> function**

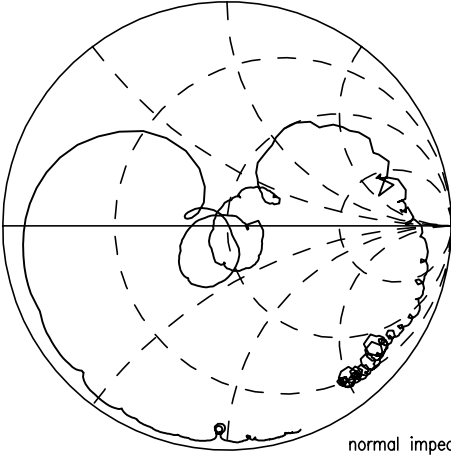

normal impedance: 150.0 Ω

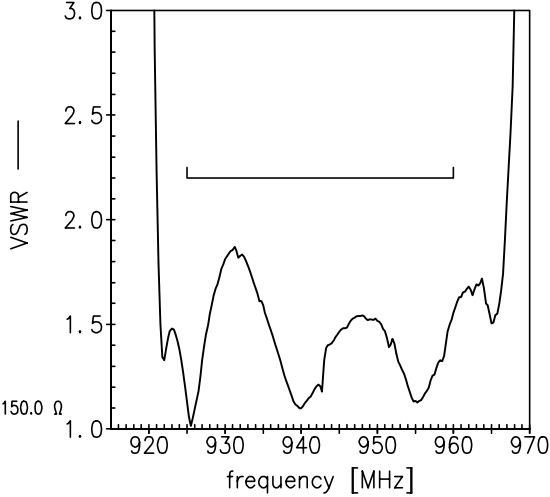

<b>SAW Components</b>	<b>B4304</b>
<b>SAW Rx filter</b>	<b>942.50 MHz</b>

Data sheet



**References**

<b>Type</b>	B4304
<b>Ordering code</b>	B39941B4304F210
<b>Marking and package</b>	C61157-A8-A8
<b>Packaging</b>	F61074-V8212-Z000
<b>Date codes</b>	L_1126
<b>S-parameters</b>	B4304_NB.s3p, B4304_WB.s3p See file header for port/pin assignment table.
<b>Soldering profile</b>	S_6001
<b>RoHS compatible</b>	RoHS-compatible means that products are compatible with the requirements according to Art. 4 (substance restrictions) of Directive 2011/65/EU of the European Parliament and of the Council of June 8 <sup>th</sup> , 2011, on the restriction of the use of certain hazardous substances in electrical and electronic equipment ("Directive") with due regard to the application of exemptions as per Annex III of the Directive in certain cases.
<b>Moldability</b>	Before using in overmolding environment, please contact your EPCOS sales office.
<b>Matching coils</b>	See Inductor pdf-catalog <a href="http://www.tdk.co.jp/tefe02/coil.htm#aname1">http://www.tdk.co.jp/tefe02/coil.htm#aname1</a> and Data Library for circuit simulation <a href="http://www.tdk.co.jp/etvcl/index.htm">http://www.tdk.co.jp/etvcl/index.htm</a>

**For further information please contact your local EPCOS sales office or visit our webpage at [www.epcos.com](http://www.epcos.com) .**

**Published by EPCOS AG  
Systems, Acoustics, Waves Business Group  
P.O. Box 80 17 09, 81617 Munich, GERMANY**

© EPCOS AG 2013. This brochure replaces the previous edition.

For questions on technology, prices and delivery please contact the Sales Offices of EPCOS AG or the international Representatives.

Due to technical requirements components may contain dangerous substances. For information on the type in question please also contact one of our Sales Offices.

## Important notes

The following applies to all products named in this publication:

1. Some parts of this publication contain **statements about the suitability of our products for certain areas of application**. These statements are based on our knowledge of typical requirements that are often placed on our products in the areas of application concerned. We nevertheless expressly point out **that such statements cannot be regarded as binding statements about the suitability of our products for a particular customer application**. As a rule, EPCOS is either unfamiliar with individual customer applications or less familiar with them than the customers themselves. For these reasons, it is always ultimately incumbent on the customer to check and decide whether an EPCOS product with the properties described in the product specification is suitable for use in a particular customer application.
2. We also point out that **in individual cases, a malfunction of electronic components or failure before the end of their usual service life cannot be completely ruled out in the current state of the art, even if they are operated as specified**. In customer applications requiring a very high level of operational safety and especially in customer applications in which the malfunction or failure of an electronic component could endanger human life or health (e.g. in accident prevention or life-saving systems), it must therefore be ensured by means of suitable design of the customer application or other action taken by the customer (e.g. installation of protective circuitry or redundancy) that no injury or damage is sustained by third parties in the event of malfunction or failure of an electronic component.
3. **The warnings, cautions and product-specific notes must be observed.**
4. In order to satisfy certain technical requirements, **some of the products described in this publication may contain substances subject to restrictions in certain jurisdictions (e.g. because they are classed as hazardous)**. Useful information on this will be found in our Material Data Sheets on the Internet ([www.epcos.com/material](http://www.epcos.com/material)). Should you have any more detailed questions, please contact our sales offices.
5. We constantly strive to improve our products. Consequently, **the products described in this publication may change from time to time**. The same is true of the corresponding product specifications. Please check therefore to what extent product descriptions and specifications contained in this publication are still applicable before or when you place an order. We also **reserve the right to discontinue production and delivery of products**. Consequently, we cannot guarantee that all products named in this publication will always be available. The aforementioned does not apply in the case of individual agreements deviating from the foregoing for customer-specific products.
6. Unless otherwise agreed in individual contracts, **all orders are subject to the current version of the “General Terms of Delivery for Products and Services in the Electrical Industry” published by the German Electrical and Electronics Industry Association (ZVEI)**.
7. The trade names EPCOS, BAOKE, Alu-X, CeraDiode, CeraLink, CeraPlas, CSMP, CSSP, CTVS, DeltaCap, DigiSiMic, DSSP, FilterCap, FormFit, MiniBlue, MiniCell, MKD, MKK, MLSC, MotorCap, PCC, PhaseCap, PhaseCube, PhaseMod, PhiCap, SIFERRIT, SIFI, SIKOREL, SilverCap, SIMDAD, SiMic, SIMID, SineFormer, SIOV, SIP5D, SIP5K, ThermoFuse, WindCap are **trademarks registered or pending** in Europe and in other countries. Further information will be found on the Internet at [www.epcos.com/trademarks](http://www.epcos.com/trademarks).