



April. 2016 Ver.1.2  
TDK Corporation

## Multilayer Band Pass Filter (Balance output type)

For 2.4GHz W-LAN & Bluetooth

DEA Series

2012 TYPE

P/N: **DEA202450BT-7227A1-H**

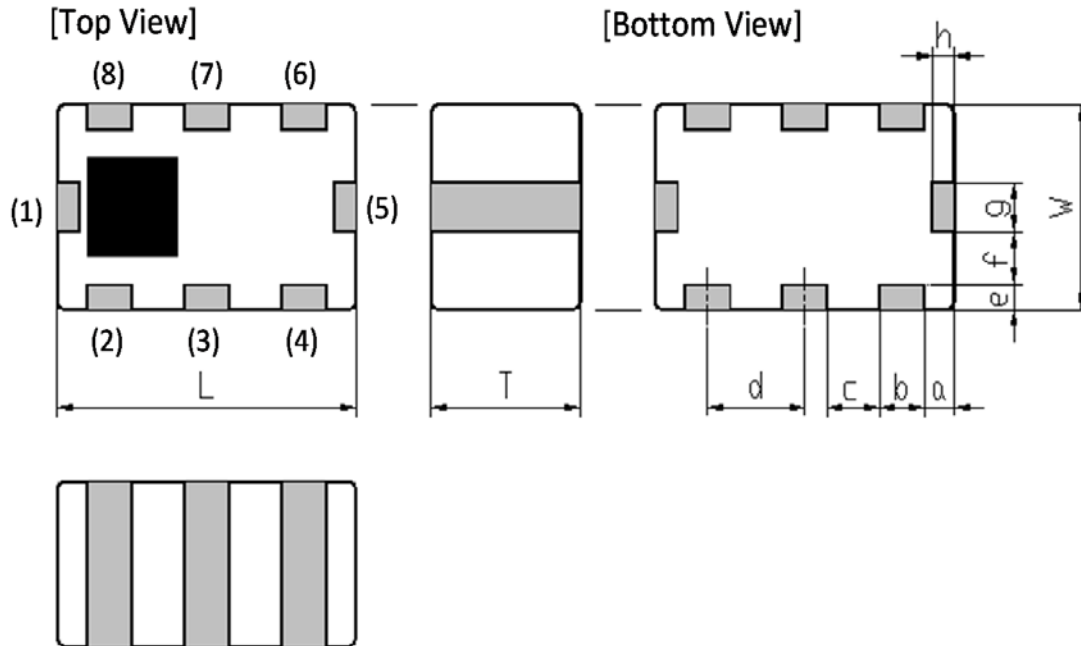
**DEA202450BT-7227A1-H****SHAPES AND DIMENSIONS**

Dimensions (mm)

L	W	T	a	b	c	d	e	g	h
2.00	1.25	1.00	0.20	0.30	0.35	0.65	0.25	0.30	0.25
+/-0.15	+/-0.15	Max	+/-0.20	+/-0.20	+/-0.15	+/-0.15	+/-0.20	+/-0.20	+/-0.20

Terminal functions

(1)	Unbalanced Port
(2)	GND
(3)	GND
(4)	Balanced Port
(5)	DC feed or N.C.

(6)	Balanced Port
(7)	GND
(8)	GND

**TEMPERATURE RANGE**

Operating temperature	Storage temperature
-40 to +85 °C	-40 to +85 °C

**TERMINATION FINISH**

Material
Sn plate

## DEA202450BT-7227A1-H

### ■ ELECTRICAL CHARACTERISTICS

( Measurement )

Parameter	Frequency (MHz)	TDK Spec		
		Min.	Typ.	Max.
Unbalanced Port Characteristic Impedance (ohm)	2400~2500	50 (Nominal)		
Balanced Port Characteristic Impedance (ohm)	2400~2500	50 (Nominal)		
Insertion Loss (dB)	2400 to 2500	-	2.19	2.7
	to	-		
	to	-		
Attenuation (dB)	824 to 960	45	48.4	-
	1710 to 1990	38	41.8	-
	1850	38	42.1	-
	2110 to 2170	25	42.2	-
	4800 to 5000	40	59.6	-
	7200 to 7500	40	53.0	-
Return Loss at Unbalanced Port (dB)	2400 to 2500	9	16.0	-
Return Loss at Balanced Port (dB)	2400 to 2500	9	19.1	-
Phase Balance (deg.)	2400 to 2500	160	167	180
Amplitude Balance (dB)	2400 to 2500	-1	0.39	3
Power Handling (W)		-		0.5

Ta = +25+/-5°C

## DEA202450BT-7227A1-H

### FREQUENCY CHARACTERISTICS

Insertion Loss

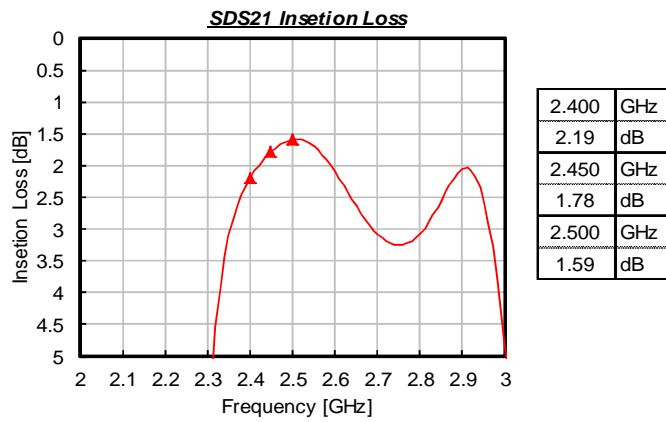

Unbalance Return Loss

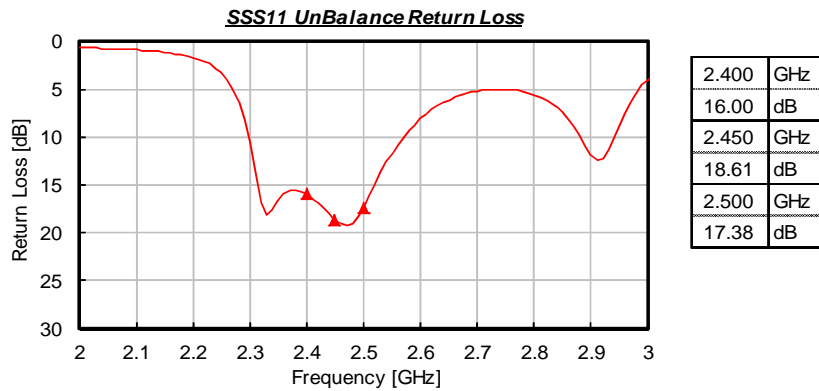

Attenuation

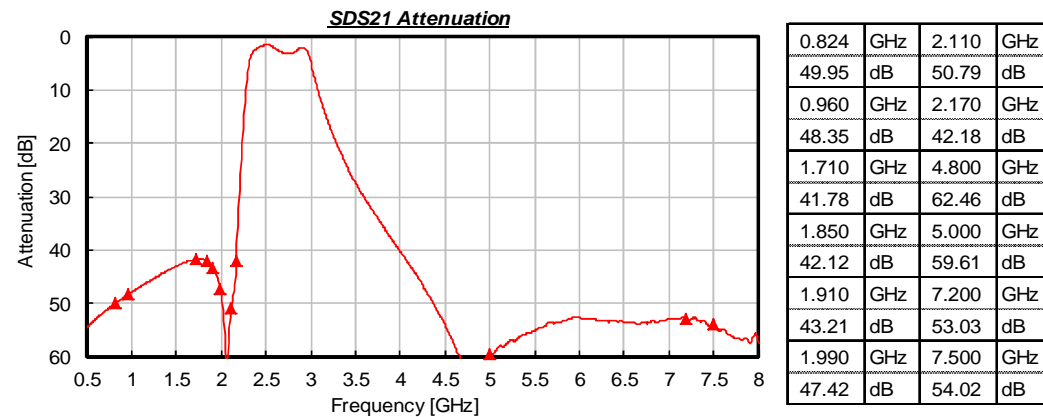

## DEA202450BT-7227A1-H

### ■ FREQUENCY CHARACTERISTICS

#### Amplitude Balance

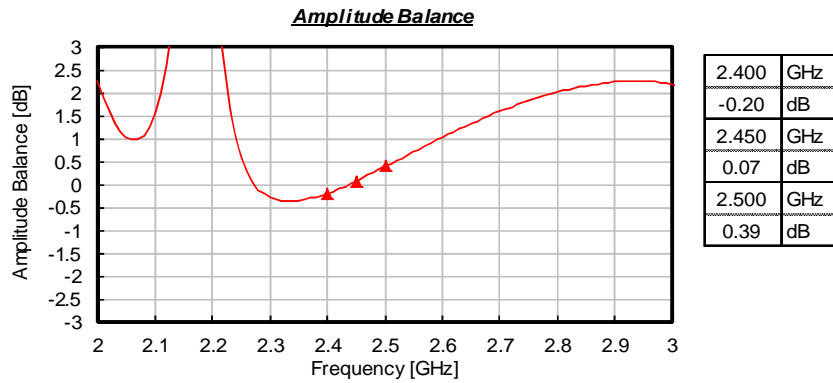

#### Phase Balance

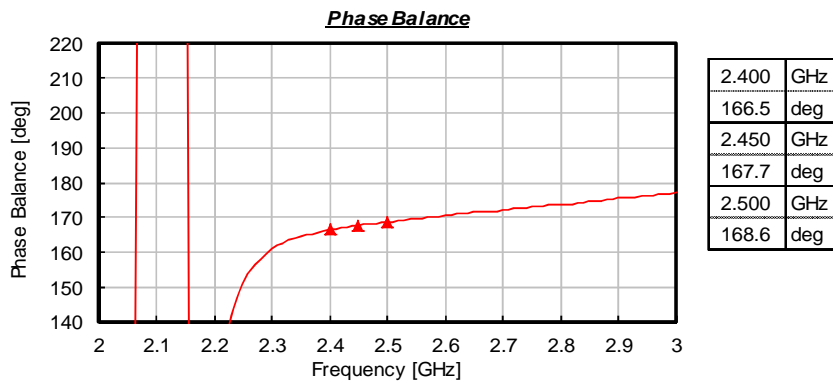

#### Balance Return Loss

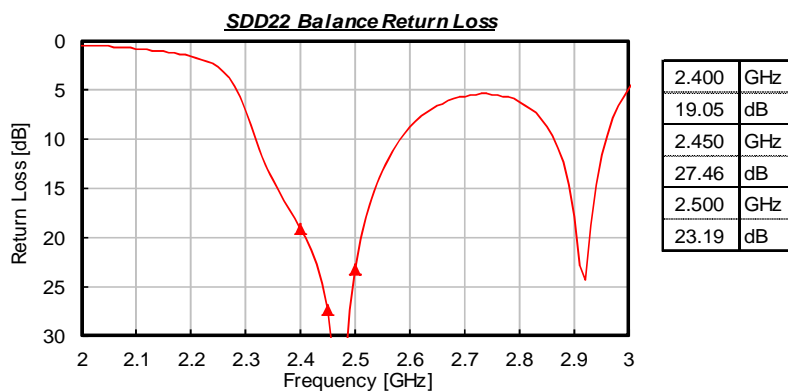

## DEA202450BT-7227A1-H

### RECOMMENDED LAND PATTERN

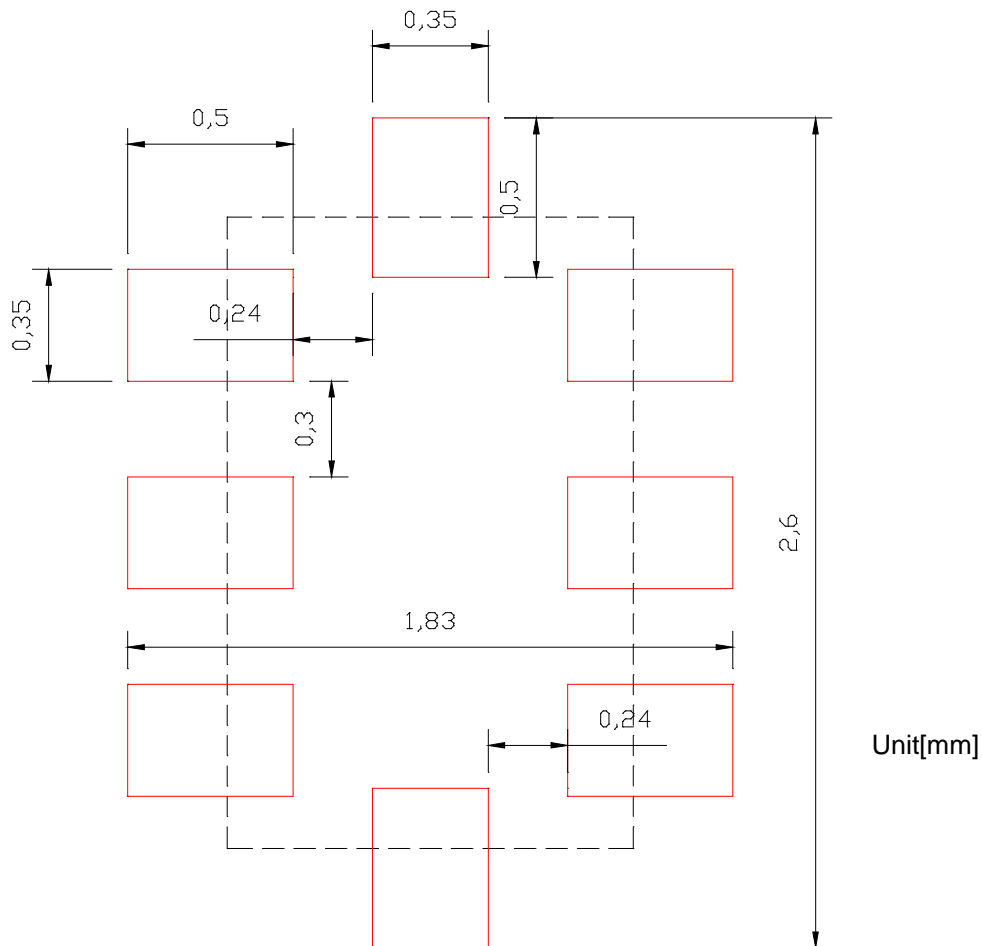

### ENVIROMENT INFORMATION

RoHS Statement  
RoHS Compliance

## DEA202450BT-7227A1-H

### RECOMMENDED REFLOW PROFILE

Pb free solder

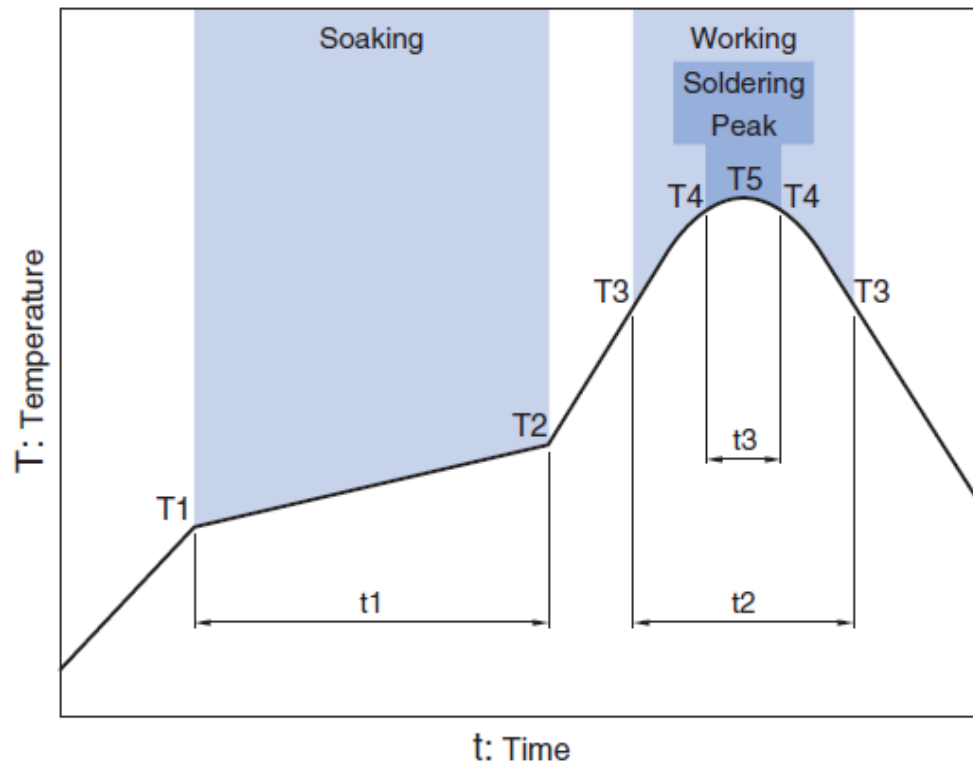

Soaking			Working		Soldering		Peak
Temp.	Temp.	Time	Temp.	Time	Temp.	Time	Temp.
T1	T2	t1	T3	t2	T4	t3	T5
150°C	180°C	60 to 120sec	230°C	more than 30sec	247 to 253°C	within 10sec	260°C Max.

## DEA202450BT-7227A1-H

### ■ PACKAGING STYLE

Reel Dimensions

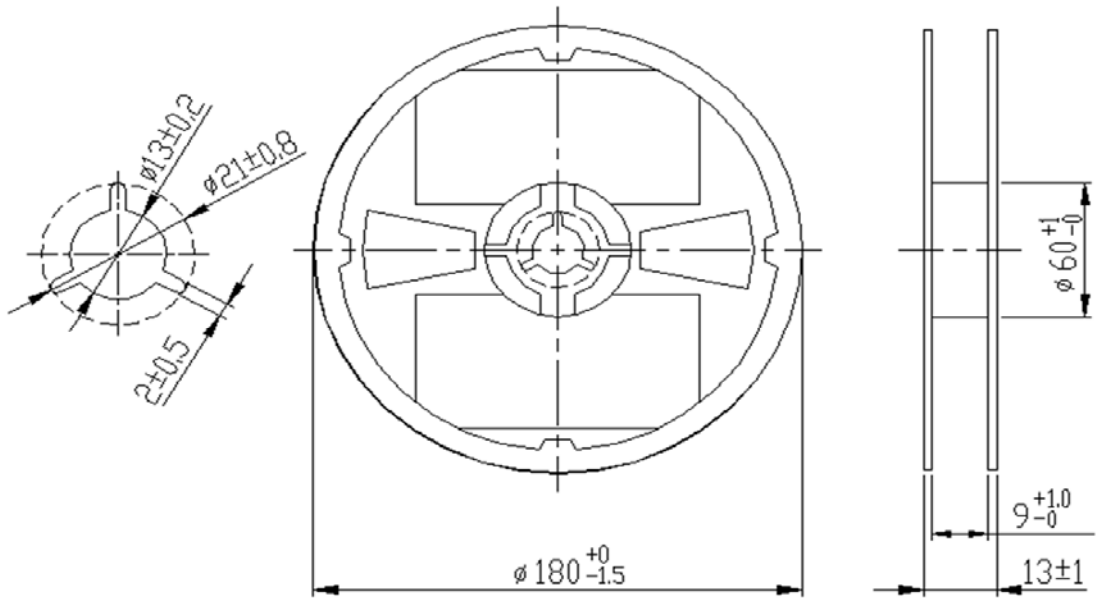

Dimensions in mm

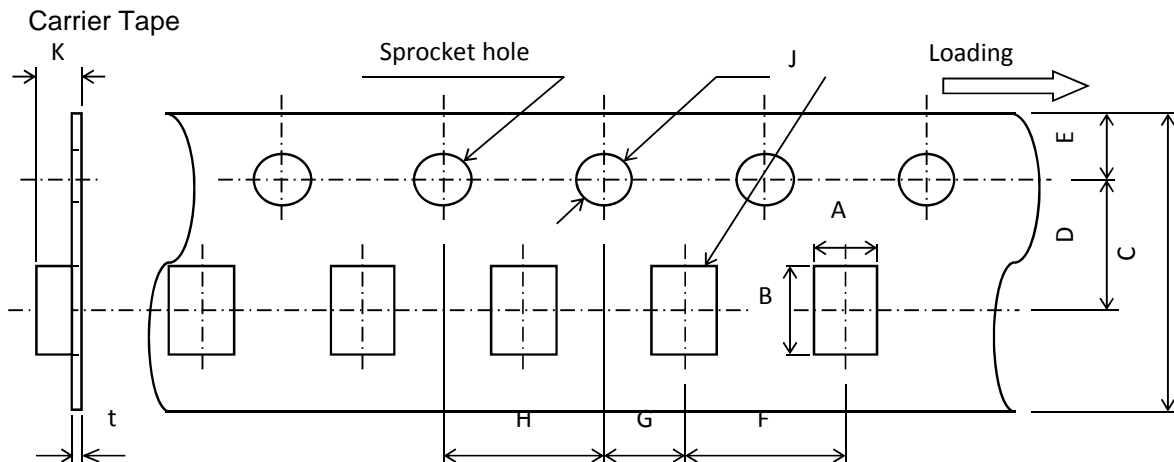

Dimensions (mm)

A	B	C	D	E	F	G	H	J	K	t
1.45	2.2	8.0	3.5	1.75	4.0	2.0	4.0	1.5	1.15	0.25
+/-0.05	+/-0.05	+0.3/-0.1	+/-0.05	+/-0.1	+/-0.1	+/-0.05	+/-0.1	+0.1/-0	MAX	+/-0.05

**STANDARD PACKAGE QUANTITY**

**( pieces/reel )**

2,000



## REMINDERS FOR USING THESE PRODUCTS

Before using these products, be sure to request the delivery specifications.

### SAFETY REMINDERS

Please pay sufficient attention to the warnings for safe designing when using these products.

#### REMINDERS

The products listed on this specification sheet are intended for use in general electronic equipment (AV equipment, telecommunications equipment, home appliances, amusement equipment, computer equipment, personal equipment, office equipment, measurement equipment, industrial robots) under a normal operation and use condition.

The products are not designed or warranted to meet the requirements of the applications listed below, whose performance and/or quality require a more stringent level of safety or reliability, or whose failure, malfunction or trouble could cause serious damage to society, person or property. Please understand that we are not responsible for any damage or liability caused by use of the products in any of the applications below or for any other use exceeding the range or conditions set forth in this specification sheet.

1. Aerospace/Aviation equipment
2. Transportation equipment (cars, electric trains, ships, etc.)
3. Medical equipment
4. Power-generation control equipment
5. Atomic energy-related equipment
6. Seabed equipment
7. Transportation control equipment
8. Public information-processing equipment
9. Military equipment
10. Electric heating apparatus, burning equipment
11. Disaster prevention/crime prevention equipment
12. Safety equipment
13. Other applications that are not considered general-purpose applications

When using this product in general-purpose applications, you are kindly requested to take into consideration securing protection circuit/equipment or providing backup circuits, etc., to ensure higher safety.