



ANATECH ELECTRONICS INC
RF & Microwave Filters & Products

3400 MHz Strip-Line High Pass Filter

Part Number: AE3400SLH1007



Electrical Specifications

Frequency Range: 3400-10000 MHz
Insertion Loss: 1.5 dB Max
VSWR: 1.80:1 Max
Return Loss: 10 dB Min
Rejection: 40 dB @ DC-2700 MHz
Power Handling: 20 Watts

Mechanical

Connector Type: SMA (F)
Dimensions: 50 x 33 x 11 mm

Environmental

Operating Temperature: -40 to +85° C

Outline Drawing:

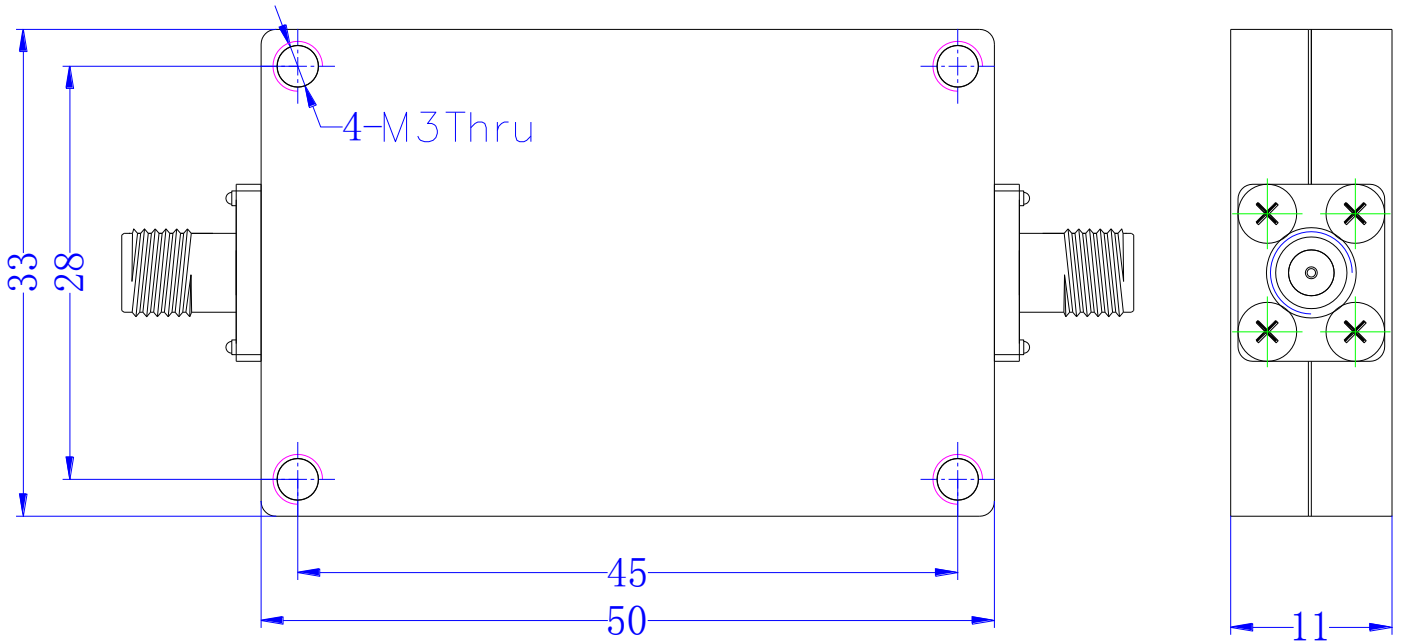

Tolerance: ± 0.3 .

Dimension: mm