



ANATECH ELECTRONICS INC
RF & Microwave Filters & Products

2 MHz LC Band Pass Filter

Part Number: AE2B5442



Electrical Specifications

Center Frequency: 2 MHz
3dB Passband: 1.68-2.38 MHz
Insertion Loss: 4.0dB Max.
Return Loss: 14dB Min.
Rejection: $\geq 40\text{dB}$ @ 1.42 MHz
Rejection2: $\geq 40\text{dB}$ @ 2.82 MHz
Impedance: 50 Ohms

Mechanical

Mounting Method: Threaded Holes
Connector Type: SMA(F)
Dimensions: 2.38" X 1.0" x 1.0".

Environmental

Operating Temperature: -25°C to +70°C
Storage Temperature: -40°C to +90°C
Shock: 10 G. 11ms
Vibration: 10 G. 5 to 200Hz

Outline Drawing:

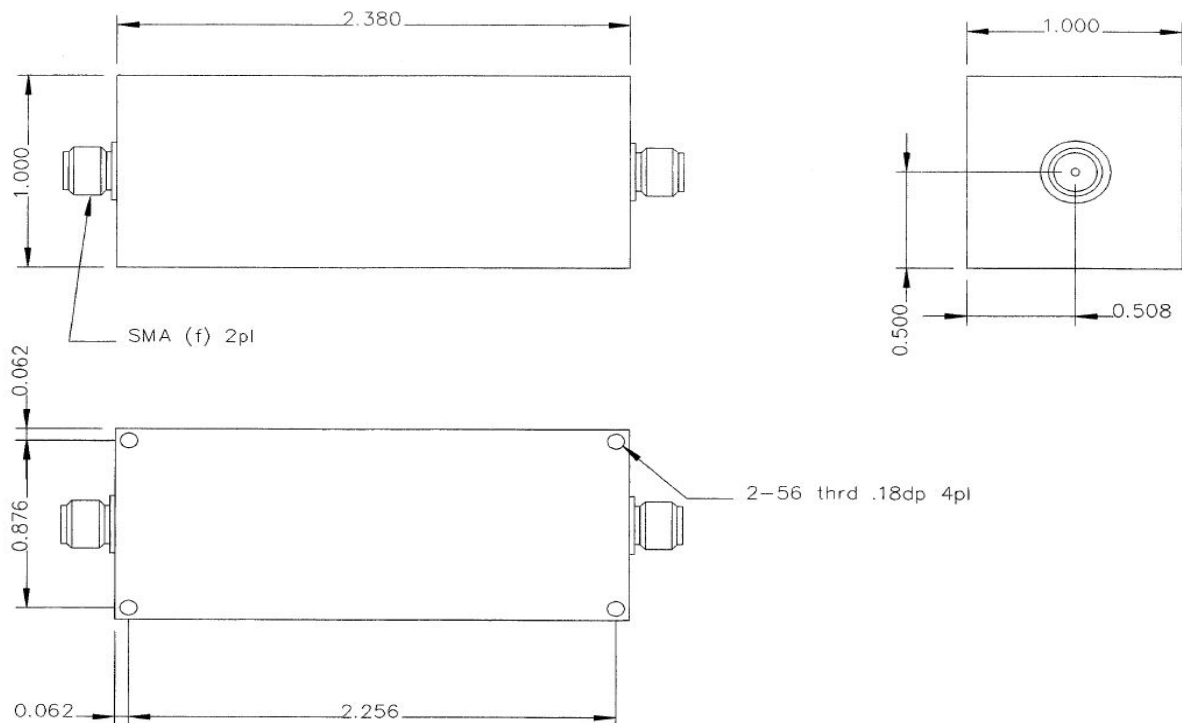

Tolerance: +/-0.01 inches [+/- 0.3mm]

Angles: +/- 1 Deg.

*Tolerance as shown unless otherwise specified in the datasheet electrical specification tables above.

*When max dimensions are called out the above tolerances do not apply as long as it is under the max call out.

70 Outwater Lane Phone: (973) 772-4242
Garfield, NJ 07026 Fax : (973) 321-3941

Email: sales@anatechelectronics.com
Web: www.anatechelectronics.com



Simulation Plot:

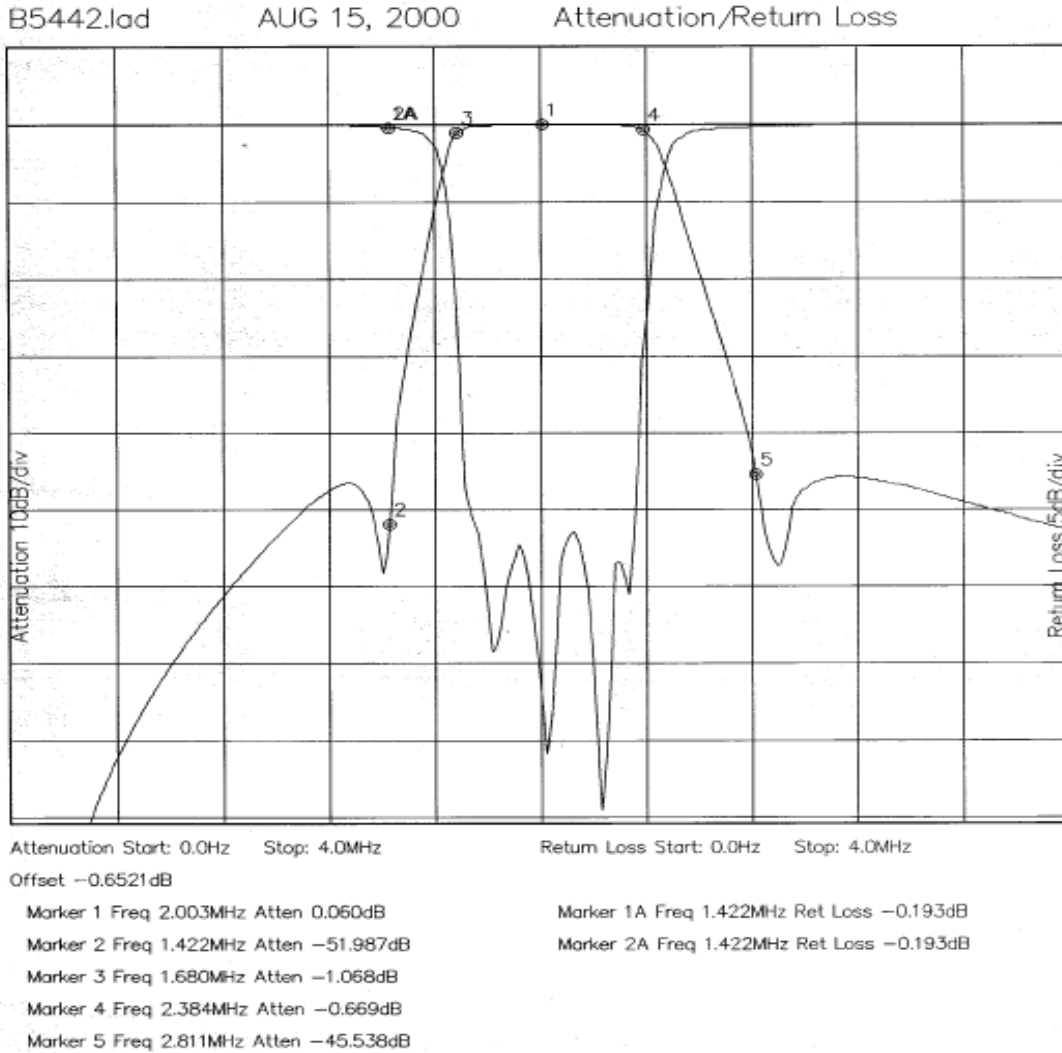

Note: This is a simulation Plot. Actual response plot might differ once product is manufactured.