



Multilayer Band Pass Filter

For 2412-2484MHz

DEA202450BT-1294C1-H

2.0x1.25mm [EIA 0805]*

* Dimensions Code JIS[EIA]

Caution

**The products in this catalog will be or have been
stopped production**

Discontinue Issue Date	Jun. 3, 2022
Last Purchase Order Date	Mar. 31, 2023
Last Shipment Date	Mar. 31, 2024

Please refer to our Web site about replacement information.

Multilayer Band Pass Filter

Conformity to RoHS Directive

For 2412-2484MHz

DEA202450BT-1294C1-H

SHAPES AND DIMENSIONS

[Top view]

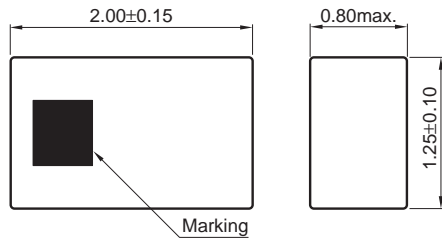

[Bottom view]

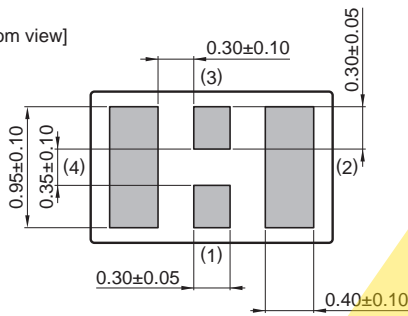

Terminal functions

- | | |
|---|-----|
| 1 | In |
| 2 | GND |
| 3 | Out |
| 4 | GND |

Dimensions in mm

RECOMMENDED LAND PATTERN

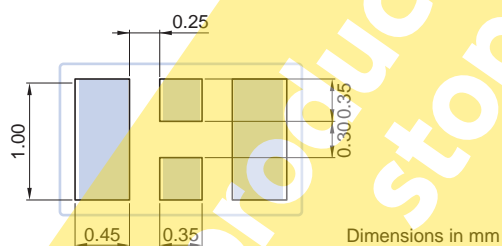

EVALUATION BOARD

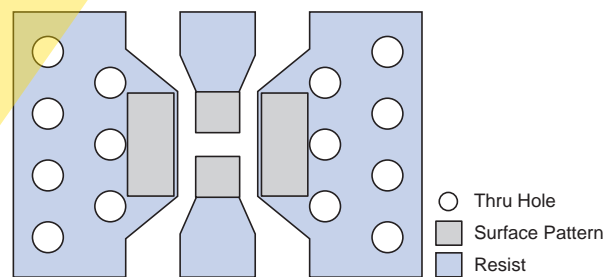

Material & Layer	Thickness
Top resist	-
Copper surface pattern	0.035mm
FR4	0.10mm
Inner GND	0.018mm
FR4	0.30mm
Copper bottom GND	0.035mm

Line width should be designed to match 50Ω characteristic impedance, depending on PCB material and thickness.

RoHS Directive Compliant Product: See the following for more details. <https://product.tdk.com/info/en/environment/rohs/index.html>

- All specifications are subject to change without notice.
- Before using these products, be sure to request the delivery specifications.

DEA202450BT-1294C1-H

ELECTRICAL CHARACTERISTICS

Item	Frequency Range (MHz)	Min.	Typ.	Max.
Insertion Loss (dB)	2412 to 2484	—	1.02	1.35
Return Loss (dB)	2412 to 2484	10	22	—
	804 to 828	30	42	—
Attenuation (dB)	1608 to 1656	20	23	—
	3216 to 3312	30	49	—
	4020 to 4140	40	52	—
	4824 to 4968	20	30	—
	5628 to 5796	20	27	—
	6432 to 6624	20	42	—
	7200 to 7500	35	44	—
Characteristic Impedance (Ω)	7500 to 10000	20	30	—
				50 (Nominal)

· Ta: +25±5°C

TEMPERATURE RANGE

Operating temperature (°C)	Storage temperature (°C)
-40 to +85	-40 to +85

The products will be or have been stopped production

- All specifications are subject to change without notice.
- Before using these products, be sure to request the delivery specifications.

DEA202450BT-1294C1-H

FREQUENCY CHARACTERISTICS

INSERTION LOSS

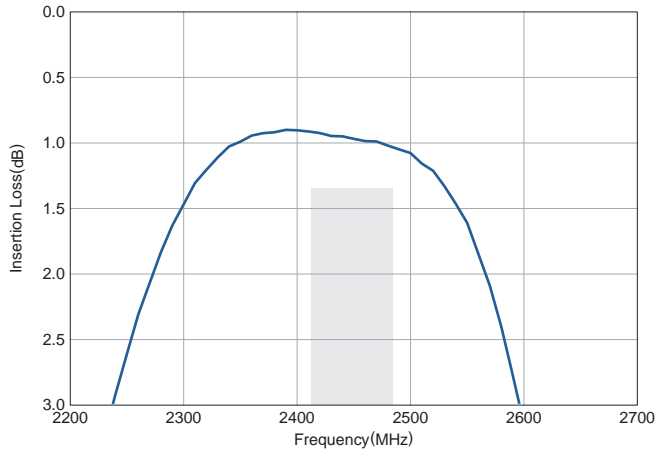

ATTENUATION

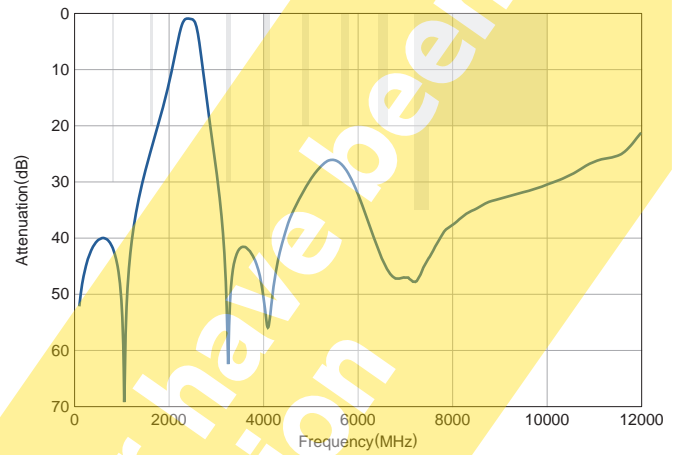

RETURN LOSS

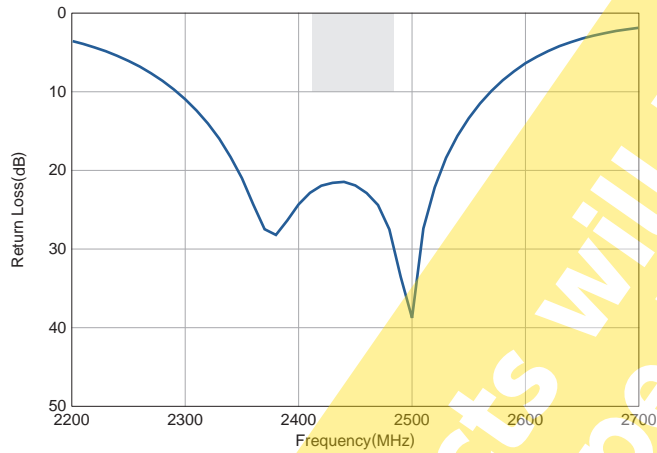

The products will be or have been stopped production

- All specifications are subject to change without notice.
- Before using these products, be sure to request the delivery specifications.

DEA202450BT-1294C1-H

PACKAGING STYLE

REEL DIMENSIONS

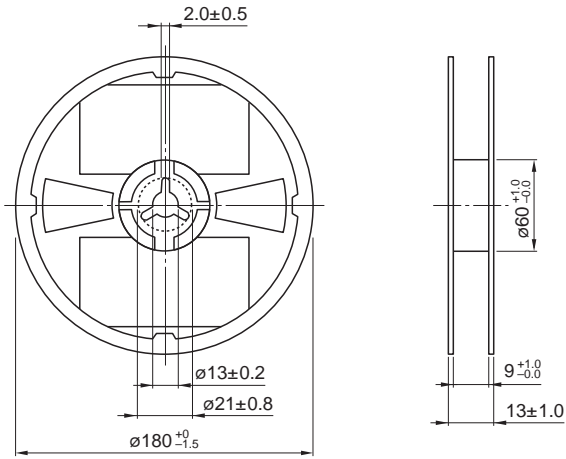

Dimensions in mm

TAPE DIMENSIONS

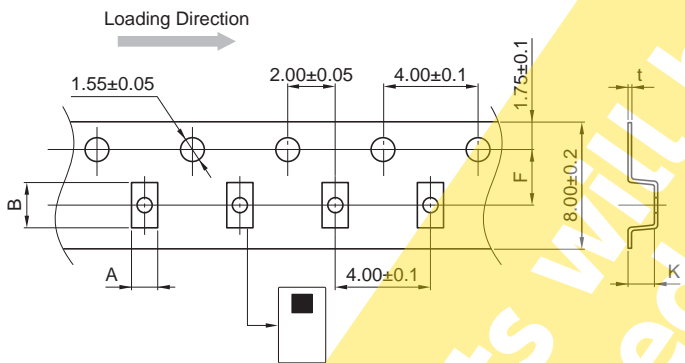

A	B	F	t	K
1.45±0.1	2.25±0.1	3.50±0.05	0.25±0.05	1.00±0.05

PACKAGE QUANTITY

Standard package quantity (pieces/reel)
2000

- All specifications are subject to change without notice.
- Before using these products, be sure to request the delivery specifications.

RECOMMENDED REFLOW PROFILE

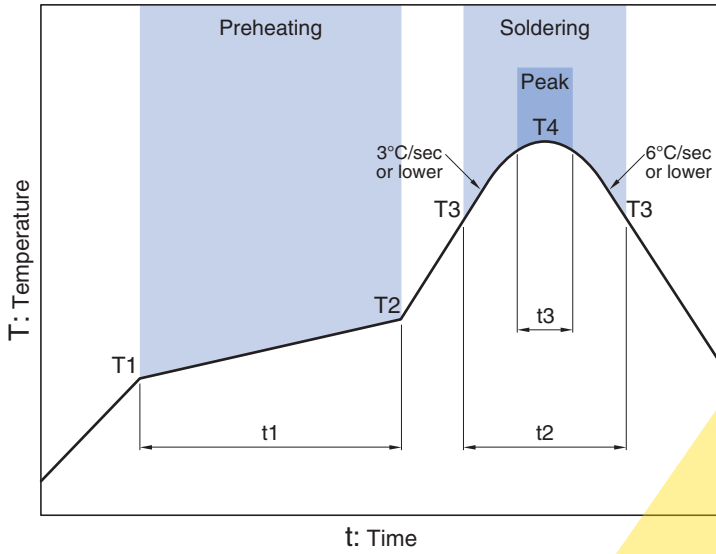

Preheating			Soldering			
			Critical zone (T3 to T4)		Peak	
Temp.	Temp.	Time	Temp.	Time	Temp.	Time
T1	T2	t1	T3	t2	T4	t3*
150°C	200°C	60 to 120sec	217°C	60 to 120sec	240 to 260°C	30sec max.

* t3 : Time within 5°C of actual peak temperature
 The maximum number of reflow is 3.

The products will be or have been stopped production

REMINDERS FOR USING THESE PRODUCTS

Before using these products, be sure to request the delivery specifications.

SAFETY REMINDERS

Please pay sufficient attention to the warnings for safe designing when using these products.

REMINDERS

The products listed on this catalog are intended for use in general electronic equipment (AV equipment, telecommunications equipment, home appliances, amusement equipment, computer equipment, personal equipment, office equipment, measurement equipment, industrial robots) under a normal operation and use condition.

The products are not designed or warranted to meet the requirements of the applications listed below, whose performance and/or quality require a more stringent level of safety or reliability, or whose failure, malfunction or trouble could cause serious damage to society, person or property.

Please understand that we are not responsible for any damage or liability caused by use of the products in any of the applications below or for any other use exceeding the range or conditions set forth in this catalog.

- | | |
|---|--|
| (1) Aerospace/Aviation equipment | (8) Public information-processing equipment |
| (2) Transportation equipment (cars, electric trains, ships, etc.) | (9) Military equipment |
| (3) Medical equipment | (10) Electric heating apparatus, burning equipment |
| (4) Power-generation control equipment | (11) Disaster prevention/crime prevention equipment |
| (5) Atomic energy-related equipment | (12) Safety equipment |
| (6) Seabed equipment | (13) Other applications that are not considered general-purpose applications |
| (7) Transportation control equipment | |

When using this product in general-purpose applications, you are kindly requested to take into consideration securing protection circuit/equipment or providing backup circuits, etc., to ensure higher safety.