

NEW!
Four Section
Models

Reflectionless Band Pass Filter

XBF Series

50Ω 15.5 to 20.5 GHz

The Big Deal

- High Stopband rejection, up to 60 dB
- Patented design terminates stopband signals
- Stop band up to 40 GHz
- Excellent repeatability through IPD* process

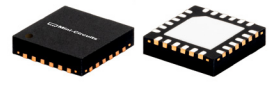

CASE STYLE: DG1847

Product Overview

Mini-Circuits' XBF-Series are GaAs MMIC reflectionless filters which includes 4-sections, giving you ultra-high rejection in the stopband – up to 50 dB! Reflectionless filters employ a patented filter topology which absorbs and terminates stopband signals internally rather than reflecting them back to the source. This new capability enables unique applications for filter circuits beyond those suited to traditional approaches. Traditional filters are reflective in the stopband, sending signals back to the source at 100% power. These reflections interact with neighboring components and often result in intermodulation and other interferences. By eliminating stopband reflections, reflectionless filters can readily be paired with sensitive devices and used in applications that otherwise require circuits such as isolation amplifiers or attenuators.

Key Features	Advantages
Choice of BW 15.5 - 16.5 GHz 17.5 - 18.5 GHz 19.5 - 20.5 GHz	Three different models to cover the band XBF-163+ XBF-183+ XBF-24+
Easy integration with sensitive reflective components, e.g. mixers, multipliers	Reflectionless filters absorb unwanted signals, preventing reflections back to the source. This reduces generation of additional unwanted signals without the need for extra components like attenuators, improving system dynamic range and saving board space.
High stopband rejection, up to 60 dB	Ideal for applications where suppression of strong spurious signals and intermodulation products is needed.
Enables stable integration of wideband amplifiers	Because reflectionless filters maintain good impedance in the stop band; they can be integrated with high gain, wideband amplifiers without the risk of creating instabilities in these out of band regions.
Cascadable	Reflectionless filters can be cascaded in multiple sections to provide sharper and higher attenuation, while also preventing any standing waves that could affect pass band signals.
Excellent power handling in a tiny surface mount device up to 0.5W in passband	High power handling extends the usability of these filters to the transmit path for inter-stage filtering.
Small size, 4x4mm MCLP	Allows replacement of filter/attenuator pairs with a single reflectionless filter, saving board space. Tiny footprint saves space in dense layouts while providing low inductance, repeatable transitions, and excellent thermal contact to the PCB.
Excellent repeatability of RF performance	Through semiconductor IPD process, X-series filters are inherently repeatable for large volume production.
Operating temperature up to 105°C	Suitable for operation close to high power components.

*IPD – Integrated Passive Device, is a GaAs semiconductor process

Reflectionless Band Pass Filter

XBF-163+

50Ω 15.5 to 16.5 GHz

Features

- Match to 50Ω in the stop band, eliminates undesired reflections
- Cascadable
- Good stopband rejection, 60 dB typ.
- Temperature stable, up to 105°C
- Small size, 4 x 4 mm
- Protected by US Patents 8,392,495; 9,705,467, additional patent pending
- Protected by China Patent 201080014266.1
- Protected by Taiwan Patent I581494

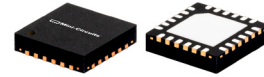

Generic photo used for illustration purposes only

CASE STYLE: DG1847

+RoHS Compliant

The +Suffix identifies RoHS Compliance. See our web site for RoHS Compliance methodologies and qualifications

Applications

- Transmitters & Receivers
- Harmonic Rejection
- Spurious Rejection

General Description

Mini-Circuits' XBF-163+ four-section reflectionless filter employs a novel filter topology which absorbs and terminates stop band signals internally rather than reflecting them back to the source. This new capability enables unique applications for filter circuits beyond those suited to traditional approaches. Traditional filters are reflective in the stop band, sending signals back to the source at 100% of the power level. These reflections interact with neighboring components and often result in inter-modulation and other interferences. Reflectionless filters eliminate stop band reflections, allowing them to be paired with sensitive devices and used in applications that otherwise require circuits such as isolation amplifiers or attenuators.

simplified schematic and pad description

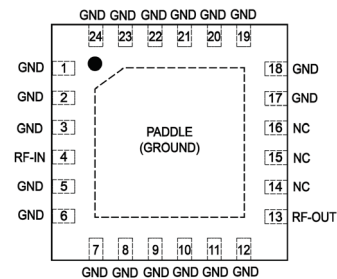
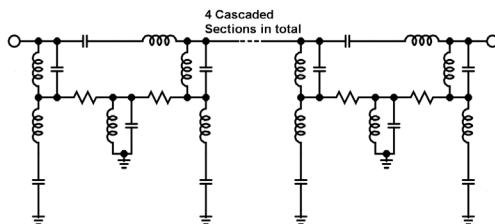

Function	Pad Number	Description
RF-IN	4	RF Input Pad
RF-OUT	13	RF Output Pad
GND	1-3, 5-12, 17-24 & paddle	Connected to ground
NC (GND Externally)	14-16	No internal connection

Electrical Specifications¹ at 25°C

Parameter	F#	Frequency (MHz)	Min.	Typ.	Max.	Unit	
Pass Band	Insertion Loss	F2-F3	15500 - 16500	—	4.7	6.0	dB
	VSWR	F2-F3	15500 - 16500	—	1.4	—	:1
Stop Band, Lower	Rejection	DC-F1	DC - 8000	49	67	—	dB
	VSWR	DC-F1	DC - 8000	—	1.2	—	:1
Stop Band, Upper	Rejection	F4-F5	24000 - 30000	44	60	—	dB
		F5-F6	30000 - 40000	34	46	—	dB
	VSWR	F4-F5	24000 - 30000	—	2.3	—	:1
		F5-F6	30000 - 40000	—	2.7	—	:1

¹ Measured on Mini-Circuits Characterization Test Board TB-968-163+

Absolute Maximum Ratings⁴

Parameter	Ratings
Operating Temperature	-55°C to +105°C
Storage Temperature	-65°C to +150°C
RF Power Input, Passband (F2-F3) ²	0.5W at 25°C
RF Power Input, Stopband (DC-F2, F3-F6) ³	0.16W at 25°C

² Passband rating derates linearly to 0.25W at 105°C ambient

³ Stopband rating derates linearly to 0.08W at 105°C ambient

⁴ Permanent damage may occur if any of these limits are exceeded.

Specification Definition

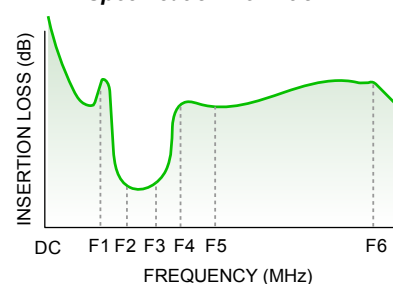

Typical Performance Data at 25°C

Frequency (GHz)	Insertion Loss (dB)	VSWR (:1)
0.01	99.94	1.04
0.1	104.72	1.04
0.5	90.67	1.05
1.0	83.61	1.05
5.0	53.08	1.30
10.0	19.48	1.40
12.0	5.18	1.14
14.0	4.12	1.20
15.5	4.30	1.27
16.5	4.80	1.38
20.0	18.89	1.22
22.0	53.81	1.53
24.0	61.73	1.31
26.0	60.08	1.33
28.0	56.24	1.64
30.0	50.43	1.52
32.0	41.94	1.31
36.0	43.07	2.06
40.0	49.50	2.77

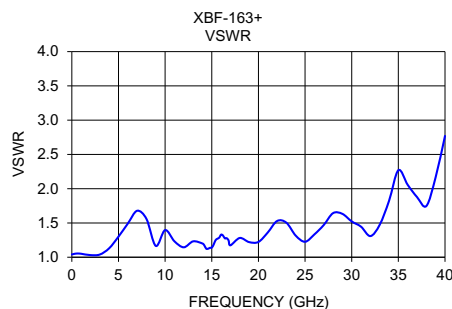
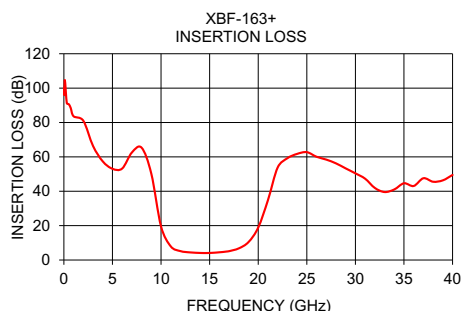

Product Marking

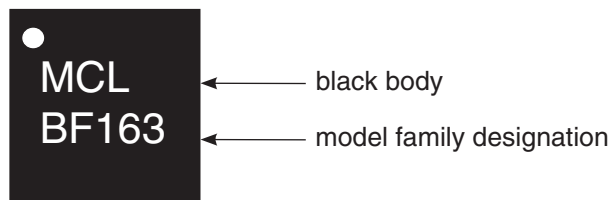

Additional Detailed Technical Information	
<i>additional information is available on our dash board. To access this information click here</i>	
Performance Data	Data Table
	Swept Graphs
	S-Parameter (S2P Files) Data Set (.zip file)
Case Style	DG1847 <i>Plastic package, exposed paddle lead finish: matte-tin</i>
Tape & Reel Standard quantities available on reel	F68 <i>7" reels with 20, 50, 100, 200, 500 or 1K devices</i>
Suggested Layout for PCB Design	PL-591
Evaluation Board	TB-968-163+
Environmental Ratings	ENV82

ESD Rating

Human Body Model (HBM): Class 1C (Pass 1000V) in accordance with ANSI/ESD STM 5.1 - 2001

MSL Test Flow Chart

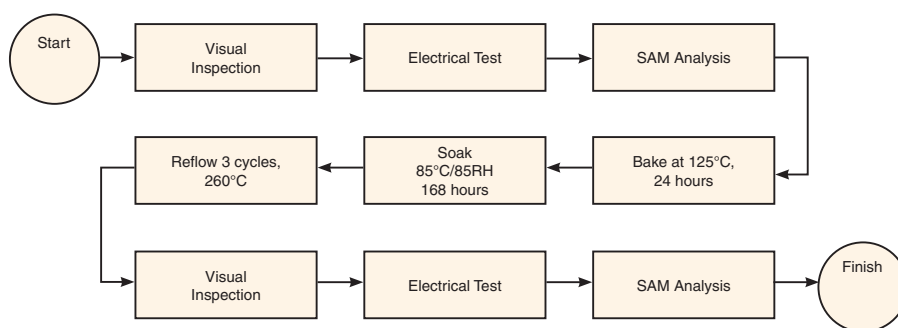

Additional Notes

- A. Performance and quality attributes and conditions not expressly stated in this specification document are intended to be excluded and do not form a part of this specification document.
- B. Electrical specifications and performance data contained in this specification document are based on Mini-Circuit's applicable established test performance criteria and measurement instructions.
- C. The parts covered by this specification document are subject to Mini-Circuits standard limited warranty and terms and conditions (collectively, "Standard Terms"); Purchasers of this part are entitled to the rights and benefits contained therein. For a full statement of the Standard Terms and the exclusive rights and remedies thereunder, please visit Mini-Circuits' website at www.minicircuits.com/MCLStore/terms.jsp

Application Circuit Example

Pairing mixers with reflectionless filters to improve system dynamic range

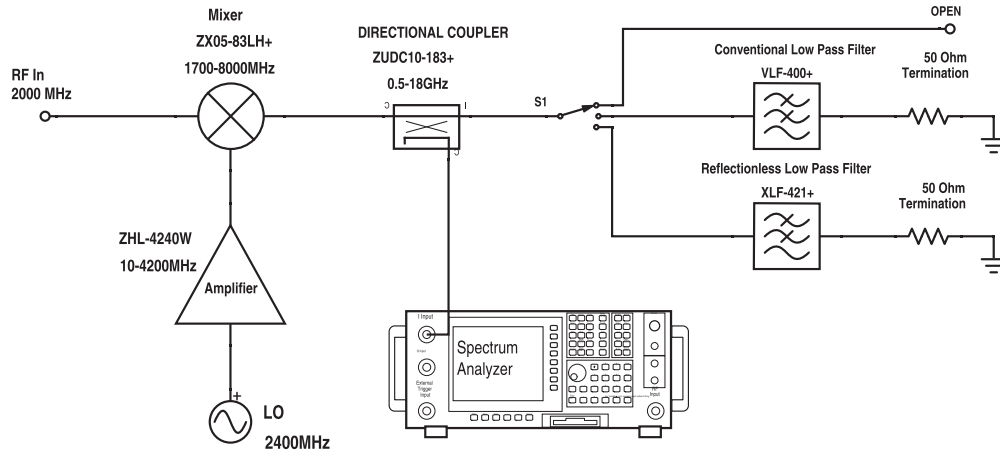

Test block diagram: IF output reflection spectrum with single input frequency

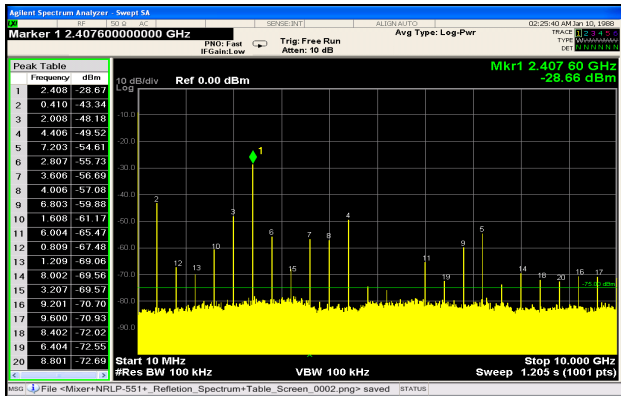

Figure 1. IF output reflection spectrum without filter

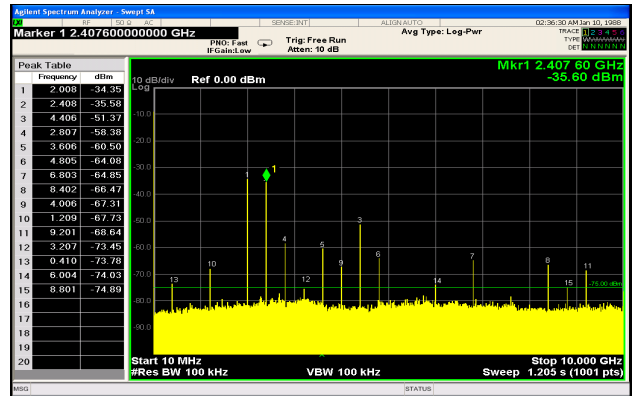

Figure 2. IF output reflection spectrum with conventional filter

An application circuit was assembled to measure the IF reflection spectrum at the output of a mixer when the mixer was paired with a conventional filter versus a reflectionless filter.

While the conventional filter reduces the reflections present when the mixer is used alone (no filter), the reflectionless filter virtually eliminates those reflections altogether.

The reflected signal at marker 1 in the figures above exhibits a reduction of more than 20 dB from -28.7 dBm to -50.3 dBm when the reflectionless filter is used as compared to the conventional filter, thus eliminating unwanted spurious mixing products and improving system dynamic range.

For more information, refer to application note [AN-75-007](#)

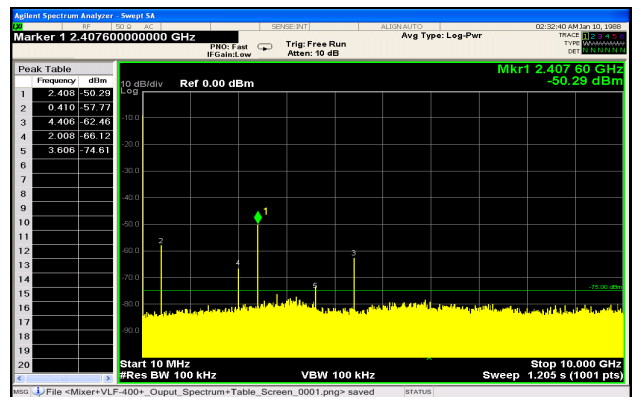

Figure 3. IF output reflection spectrum with reflectionless filter

Additional Notes

- Performance and quality attributes and conditions not expressly stated in this specification document are intended to be excluded and do not form a part of this specification document.
- Electrical specifications and performance data contained in this specification document are based on Mini-Circuit's applicable established test performance criteria and measurement instructions.
- The parts covered by this specification document are subject to Mini-Circuits standard limited warranty and terms and conditions (collectively, "Standard Terms"); Purchasers of this part are entitled to the rights and benefits contained therein. For a full statement of the Standard Terms and the exclusive rights and remedies thereunder, please visit Mini-Circuits' website at www.minicircuits.com/MCLStore/terms.jsp