

Surface Mount Bandpass Filter

BPF-C59+

50Ω 30 to 88 MHz



Generic photo used for illustration purposes only
CASE STYLE: HU1186

The Big Deal

- Low insertion loss
- Broader bandwidth
- High Rejection
- Wide stopband
- Miniature shielded package

Product Overview

The BPF-C59+ is a broad band filter in a small shielded package (size of 0.87" x 0.80" x 0.25") fabricated using SMT technology. This filter offers outstanding close in rejection, low insertion loss for use in telecommunication and broadband wireless application. The stopband extends up to 4.5 GHz

Key Features

Feature	Advantages
High Rejection	BPF-C59+ is enables the filter to attenuate spurious signals and rejects harmonics for broad band of frequency.
Low Passband VSWR	This filter maintains typical VSWR over passband frequency range making this filter easier to integrate into receiver and transmitter RF chains with less concerns for in band frequency ripple.
Small size, 0.87" x 0.80" x 0.25"	The unique surface mount package enables the BPF-C59+ to be used in compact design.

Notes

- A. Performance and quality attributes and conditions not expressly stated in this specification document are intended to be excluded and do not form a part of this specification document.
B. Electrical specifications and performance data contained in this specification document are based on Mini-Circuit's applicable established test performance criteria and measurement instructions.
C. The parts covered by this specification document are subject to Mini-Circuits standard limited warranty and terms and conditions (collectively, "Standard Terms"); Purchasers of this part are entitled to the rights and benefits contained therein. For a full statement of the Standard Terms and the exclusive rights and remedies thereunder, please visit Mini-Circuits' website at www.minicircuits.com/MCLStore/terms.jsp



Surface Mount Bandpass Filter

50Ω 30 to 88 MHz

BPF-C59+



Generic photo used for illustration purposes only
CASE STYLE: HU1186

Features

- Broader bandwidth
- Low insertion loss
- High rejection
- Wide stopband
- Miniature shielded package

Applications

- Telecommunication and broadband networks
- Air traffic control communication
- Private and public land mobile
- Transmitters / Receivers

Electrical Specifications at 25°C

Parameter	F#	Frequency (MHz)	Min.	Typ.	Max.	Unit
Pass Band	Center Frequency	—	—	59	—	MHz
	Insertion Loss	F1-F2	30-88	1.40	2.50	dB
	VSWR	F1-F2	30-88	1.28	1.92	:1
Stop Band, Lower	Insertion Loss	DC-F3	DC-22	20	—	dB
	VSWR	DC-F3	DC-22	—	20	:1
Stop Band, Upper	Insertion Loss	F4-F5	115-4500	20	—	dB
	VSWR	F4-F5	115-4500	—	20	:1

Maximum Ratings

Operating Temperature	-40°C to 85°C
Storage Temperature	-55°C to 100°C
RF Power Input	0.25 W

Permanent damage may occur if any of these limits are exceeded.

Functional Schematic

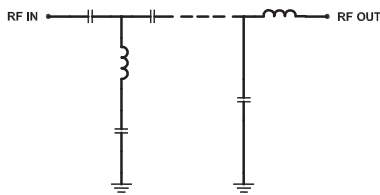

Typical Frequency Response

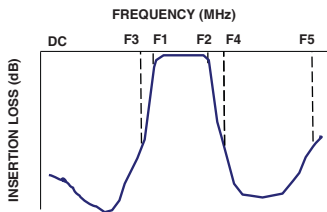

Typical Performance Data at 25°C

Frequency (MHz)	Insertion Loss (dB)	VSWR (:1)	Frequency (MHz)	Group Delay (nsec)
1.0	75.23	347.44	30.0	72.82
20.0	62.17	115.81	32.0	49.40
22.0	40.46	86.86	34.0	36.01
23.2	29.93	66.82	36.0	33.07
24.6	19.90	41.37	40.0	27.28
26.0	10.92	16.89	42.0	24.49
27.6	3.18	3.52	44.0	22.10
30.0	0.77	1.14	46.0	20.30
59.0	0.51	1.15	50.0	17.84
88.0	0.98	1.18	55.0	15.98
99.0	3.54	2.82	59.0	15.07
105.0	10.06	7.70	62.0	14.61
112.0	20.62	14.15	65.0	14.34
115.0	25.56	16.11	70.0	14.25
118.0	30.89	17.57	72.0	14.34
150.0	59.87	25.94	74.0	14.51
275.0	71.46	29.46	78.0	15.09
1500.0	71.49	6.11	80.0	15.54
3000.0	57.10	4.26	85.0	17.32
4500.0	42.06	3.30	88.0	19.06

+RoHS Compliant

The +Suffix identifies RoHS Compliance. See our web site for RoHS Compliance methodologies and qualifications

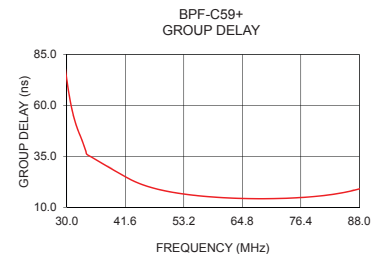
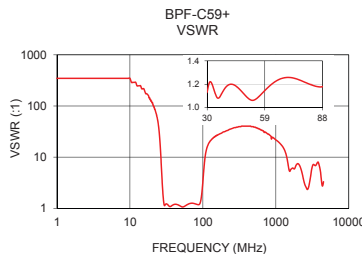
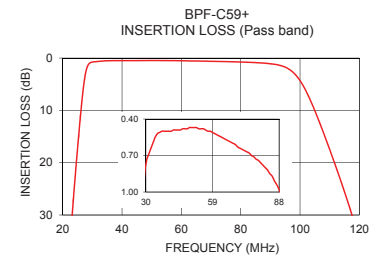
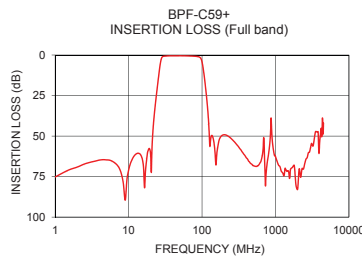

Notes

- Performance and quality attributes and conditions not expressly stated in this specification document are intended to be excluded and do not form a part of this specification document.
- Electrical specifications and performance data contained in this specification document are based on Mini-Circuit's applicable established test performance criteria and measurement instructions.
- The parts covered by this specification document are subject to Mini-Circuits standard limited warranty and terms and conditions (collectively, "Standard Terms"); Purchasers of this part are entitled to the rights and benefits contained therein. For a full statement of the Standard Terms and the exclusive rights and remedies thereunder, please visit Mini-Circuits' website at www.minicircuits.com/MCLStore/terms.jsp



www.minicircuits.com P.O. Box 350166, Brooklyn, NY 11235-0003 (718) 934-4500 sales@minicircuits.com

REV.B
M174392
BPF-C59+
EDU1797
URJ
190808
Page 2 of 3

Pad Connections

INPUT	2
OUTPUT	9
GROUND	1,3,4,5,6,7,8,10,11,12,14
NOT CONNECTED	6,13

Demo Board MCL P/N: TB-500+
Suggested PCB Layout (PL-294)

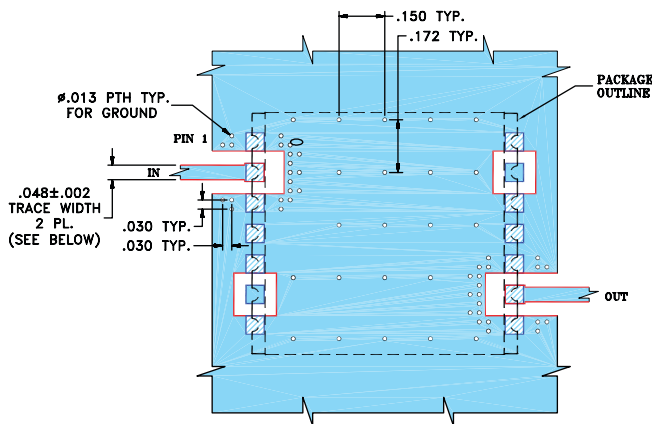

NOTES:

- TRACE WIDTH IS SHOWN FOR ROGERS R04350B, DIELECTRIC THICKNESS: $.030 \pm .002$; COPPER: 1/2 OZ ON EACH SIDE. FOR OTHER MATERIALS TRACE WIDTH MAY NEED TO BE MODIFIED.
- BOTTOM SIDE OF THE PCB IS CONTINUOUS GROUND PLANE.

DENOTES PCB COPPER LAYOUT WITH SMOBC (SOLDER MASK OVER BARE COPPER)

Outline Drawing

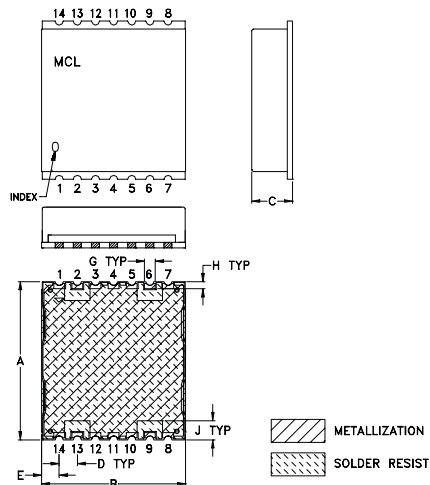

Outline Dimensions (inch/mm)

A	B	C	D	E	F	G	H
.870	.800	.25	.100	.097	--	.060	.040
22.10	20.32	6.35	2.54	2.46	--	1.52	1.02
J	K	L	M	N	P	wt	
.105	.910	--	.060	.060	--	grams	
2.67	23.11	--	1.52	1.52	--	2.85	

Note: Please refer to case style drawing for details

PCB Land Pattern

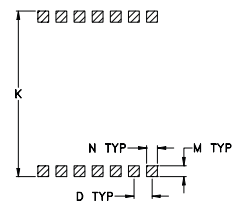

Suggested Layout,
 Tolerance to be within $\pm .002$

Notes

- Performance and quality attributes and conditions not expressly stated in this specification document are intended to be excluded and do not form a part of this specification document.
- Electrical specifications and performance data contained in this specification document are based on Mini-Circuit's applicable established test performance criteria and measurement instructions.
- The parts covered by this specification document are subject to Mini-Circuits standard limited warranty and terms and conditions (collectively, "Standard Terms"); Purchasers of this part are entitled to the rights and benefits contained therein. For a full statement of the Standard Terms and the exclusive rights and remedies thereunder, please visit Mini-Circuits' website at www.minicircuits.com/MCLStore/terms.jsp