

## 2.4 GHz low pass filter matched to STM32WB5x and STM32WB1x in WLCSP and UFBGA packages

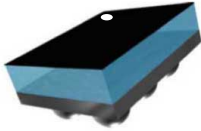

Chip scale package on glass 6 bumps

Pin-out top diagram (top view - bumps down)

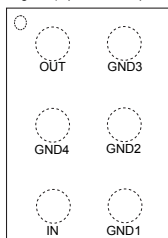

### Features

- Integrated impedance matching to STM32WB5x and STM32WB1x in WLCSP and UFBGA packages
- 50  $\Omega$  nominal impedance on antenna side
- Deep rejection harmonics filter
- Low insertion loss
- Small footprint
- Low profile  $\leq 630 \mu\text{m}$  after reflow
- High RF performances
- RF BOM and area reduction
- **ECOPACK2** compliant component

### Applications

- Bluetooth 5
- OpenThread
- Zigbee®
- IEEE 802.15.4
- Optimized for STM32WB5x and STM32WB1x in WLCSP and UFBGA packages

#### Product status link

[MLPF-WB-02D3](#)

### Description

The **MLPF-WB-02D3** integrates an impedance matching network and harmonics filter. The matching impedance network has been tailored to maximize the RF performances of STM32WB5x and STM32WB1x in WLCSP and UFBGA packages. This device uses STMicroelectronics IPD technology on non-conductive glass substrate which optimizes RF performances.

# 1 Characteristics

**Table 1. Absolute ratings ( $T_{amb} = 25\text{ °C}$ )**

Symbol	Parameter	Value	Unit
$P_{IN}$	Input power $RF_{IN}$	10	dBm
$V_{ESD}$	ESD ratings human body model (JESD22-A114-C), all I/O one at a time while others connected to GND	2000	V
$T_{OP}$	Maximum operating temperature	-40 to +105	°C

**Table 2. Impedances ( $T_{amb} = 25\text{ °C}$ )**

Symbol	Parameter	Value			Unit
		Min.	Typ.	Max.	
$Z_{IN}$	STM32WBxx single-ended impedance	-	Matched to STM32WB5x and STM32WB1x in WLCSP and UFBGA packages	-	$\Omega$
$Z_{OUT}$	Antenna impedance	-	50	-	$\Omega$

**Table 3. Electrical characteristics and RF performances ( $T_{amb} = 25\text{ °C}$ )**

Symbol	Parameter	Value			Unit
		Min.	Typ.	Max.	
f	Frequency range	2400		2500	MHz
IL	Insertion loss $ S_{21} $		1.0	1.2	dB
$RL_{IN}$	Input return loss $ S_{11} $	15	19		dB
$RL_{OUT}$	Output return loss $ S_{22} $	16	23		dB
Att	Harmonic rejection levels $ S_{21} $	Attenuation at 2fo (4800 – 5000) MHz	46	47	dB
		Attenuation at 3fo (7200 – 7500) MHz	50	54	dB
		Attenuation at 4fo (9600 – 10000) MHz	45	61	dB
		Attenuation at 5fo (12000 – 12500) MHz	38	45	dB

## 1.1 RF measurement

Figure 1. Transmission (dB)

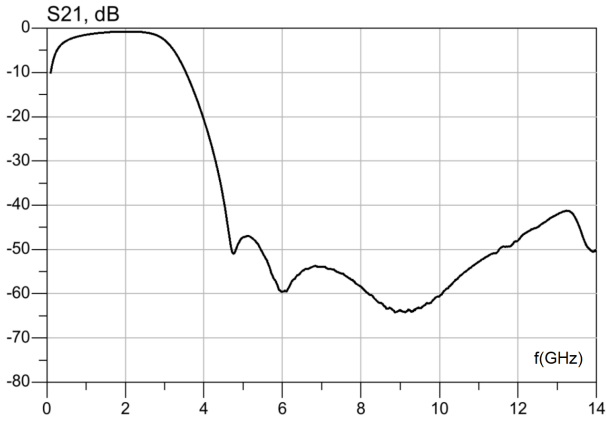

Figure 2. Insertion loss (dB)

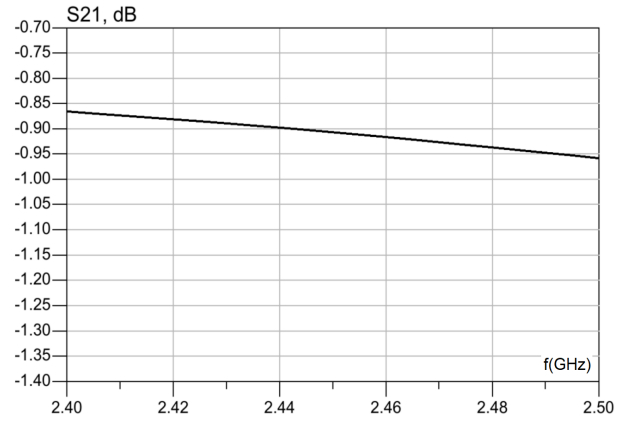

Figure 3. Input return loss (dB)

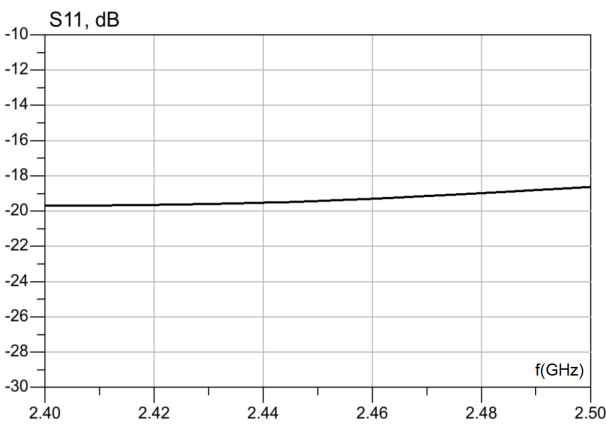

Figure 4. Output return loss (dB)

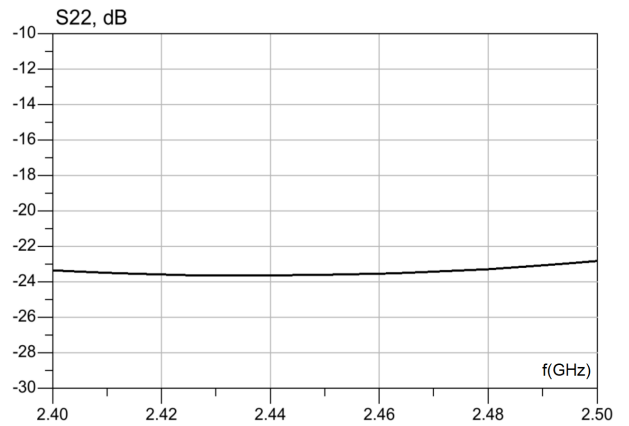

Figure 5. Attenuation 2f0 (dB)

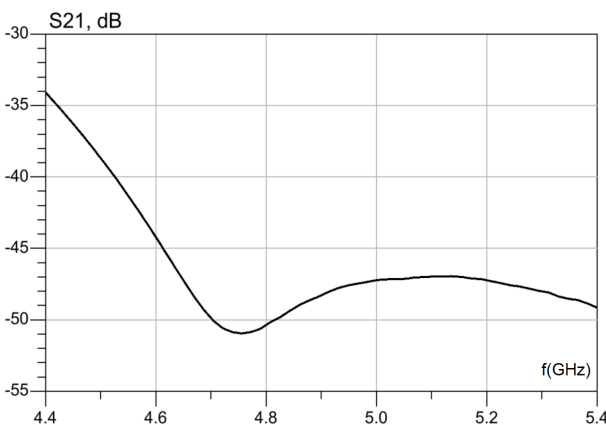

Figure 6. Attenuation 3f0 (dB)

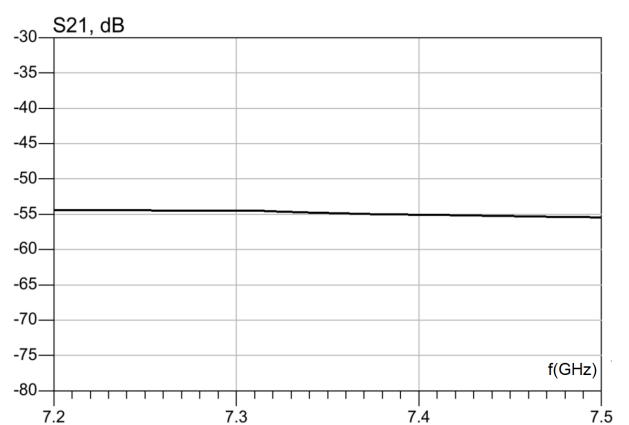

Figure 7. Attenuation 4f0 (dB)

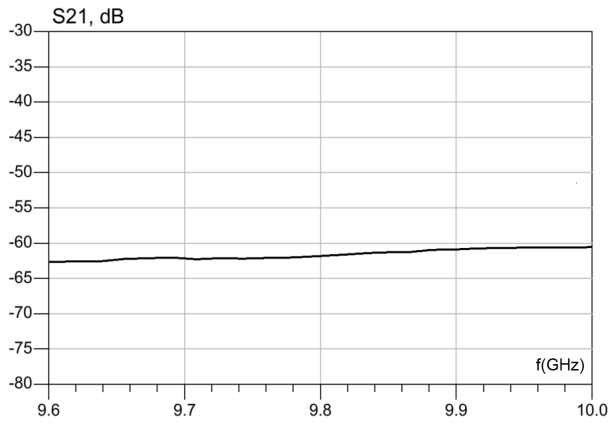
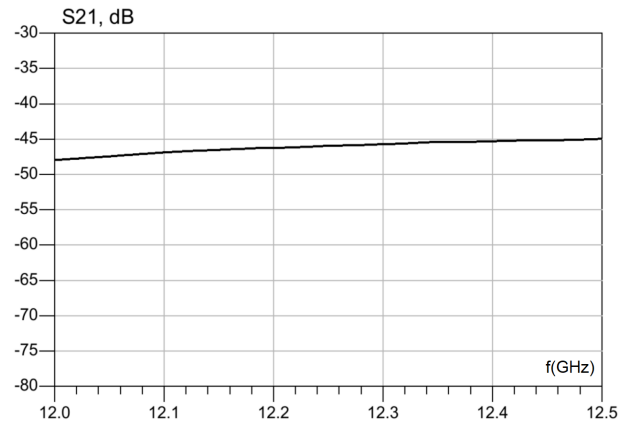

Figure 8. Attenuation 5f0 (dB)



## 2 Package information

In order to meet environmental requirements, ST offers these devices in different grades of **ECOPACK** packages, depending on their level of environmental compliance. ECOPACK specifications, grade definitions and product status are available at: [www.st.com](http://www.st.com). ECOPACK is an ST trademark.

### 2.1 CSPG package information

**Figure 9. CSPG package outline (bottom view - bumps up)**

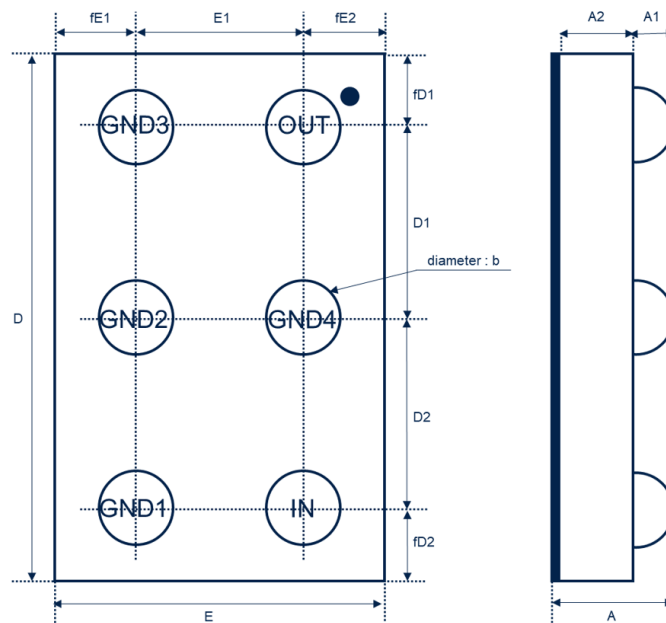

**Table 4. CSPG 6 bumps mechanical data**

Ref.	Dimensions		
	Millimeters		
	Min.	Typ.	Max.
A	0.580	0.630	0.680
A1	0.180	0.205	0.230
A2	0.380	0.400	0.420
b	0.230	0.255	0.280
D	1.550	1.600	1.650
D1		0.577	
D2		0.577	
E	0.950	1.000	1.050
E1		0.500	
fD1		0.223	
fD2		0.223	
fE1		0.250	
fE2		0.250	

**Figure 10. Marking**

Dot, ST logo  
 ■ ECOPACK® Grade  
 xx = marking  
 z = manufacturing location  
 yww = datecode  
 (y = year  
 ww = week)



**Figure 11. Top view**

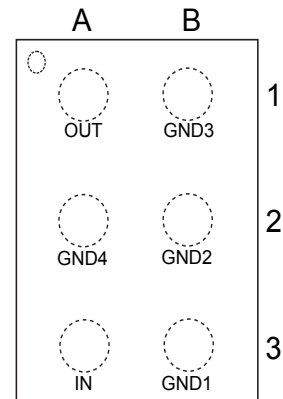

**Table 5. Pad description top view (pads down)**

Pad ref	Pad name	Description
A1	OUT	Antenna
A2	GND4	Ground
A3	IN	STM32WB5x and STM32WB1x out
B1	GND3	Ground
B2	GND2	Ground
B3	GND1	Ground

**Figure 12. Tape and reel outline**

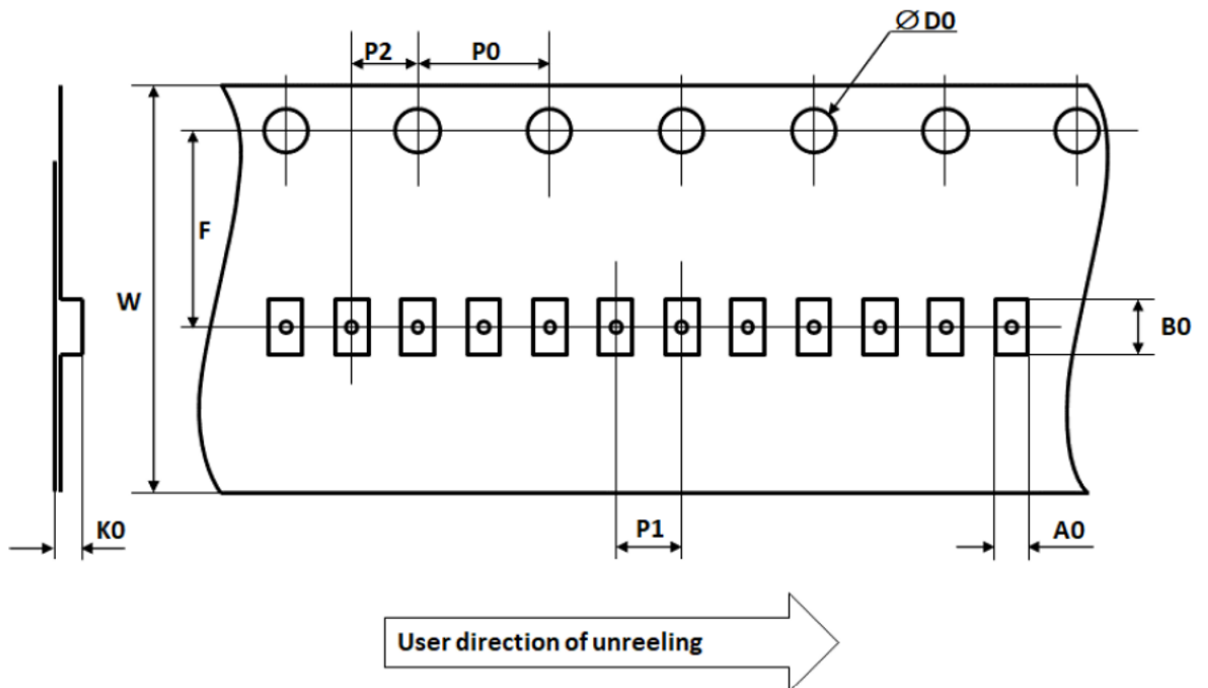

**Table 6. Tape and reel mechanical data**

Ref	Dimensions		
	Millimeters		
	Min	Typ	Max
A0	1.06	1.09	1.12
B0	1.66	1.69	1.72
D0	1.40	1.50	1.60
F	3.45	3.50	3.55
K0	0.69	0.72	0.75
P0	3.90	4.00	4.10
P1	1.95	2.00	2.05
P2	1.95	2.00	2.05
W	7.90	8.00	8.30

### 3 Recommendation on PCB assembly

#### 3.1 Land pattern

Layout example using STM32WB15CCY.

Figure 13. PCB land pattern recommendations

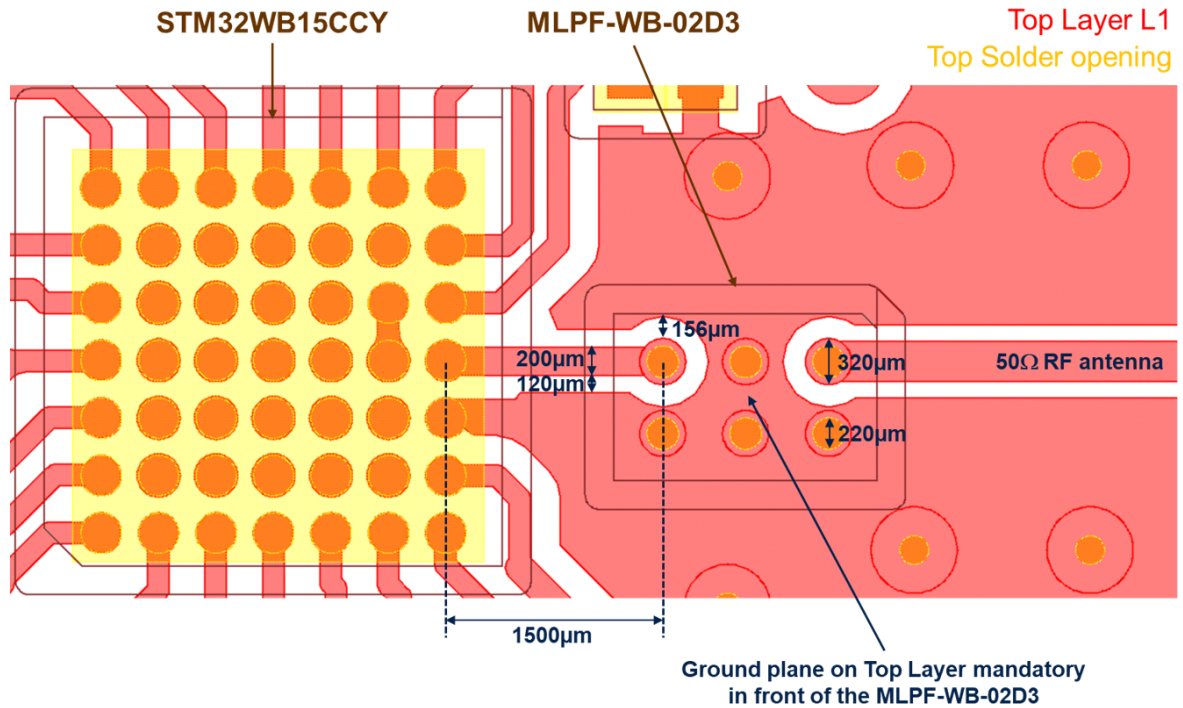

Transmission line between MLPF and antenna is dimensioned to 50 ohms characteristic impedance. Transmission line between STM32 and MLPF is dimensioned to 61 ohms characteristic impedance. These transmission line characteristic impedances have to be followed as close as possible. Moreover, lines physical dimensions will have to be tuned according to specific PCB stack up if different from the one presented in datasheet to keep expected characteristic impedance values.

Figure 14. PCB stack-up recommendations

#	Name	Material	Type	Weight	Thickness	Dk
	Top Overlay		Overlay			
	Top Solder	Solder Resist	Solder Mask		0.03mm	3.6
1	L1		Signal	1/3oz	0.012mm	
	Dielectric 1	1 x 1080	Prepreg		0.065mm	3.5
2	L2		Signal	1/3oz	0.012mm	
	Dielectric 2	1 x 2113	Prepreg		0.08mm	3.6
3	L3		Signal	1/2oz	0.0175mm	
	Dielectric 3	FR4	Core		1.2mm	4.9
4	L4		Signal	1/2oz	0.0175mm	
	Dielectric 4	1 x 2113	Prepreg		0.08mm	3.6
5	L5		Signal	1/3oz	0.012mm	
	Dielectric 5	1 x 1080	Prepreg		0.065mm	3.5
6	L6		Signal	1/3oz	0.012mm	
	Bottom Solder	Solder Resist	Solder Mask		0.03mm	3.6
	Bottom Overlay		Overlay			



## 3.2 Stencil opening design

**Figure 15. Footprint - 3 mils stencil -non solder mask defined**

Copper pad diameter:  
 220  $\mu\text{m}$  recommended  
 180  $\mu\text{m}$  minimum  
 260  $\mu\text{m}$  maximum

Solder mask opening:  
 320  $\mu\text{m}$  recommended  
 300  $\mu\text{m}$  minimum  
 340  $\mu\text{m}$  maximum

Solder stencil opening:  
 220  $\mu\text{m}$  recommended

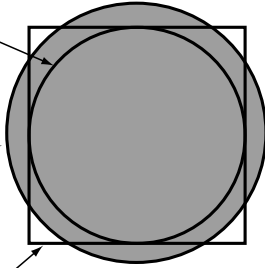
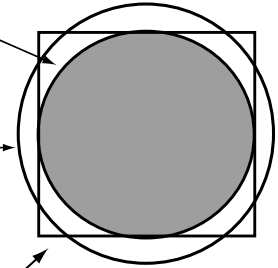

**Figure 16. Footprint - 3 mils stencil - solder mask defined**

Solder mask opening:  
 220  $\mu\text{m}$  recommended  
 180  $\mu\text{m}$  minimum  
 260  $\mu\text{m}$  maximum

Copper pad diameter:  
 320  $\mu\text{m}$  recommended  
 300  $\mu\text{m}$  minimum

Solder stencil opening:  
 220  $\mu\text{m}$  recommended



## 3.3 Solder paste

1. Halide-free flux qualification ROL0 according to ANSI/J-STD-004.
2. "No clean" solder paste is recommended.
3. Offers a high tack force to resist component movement during high speed.
4. Use solder paste with fine particles: powder particle size 20-38  $\mu\text{m}$ .

## 3.4 Placement

1. Manual positioning is not recommended.
2. It is recommended to use the lead recognition capabilities of the placement system, not the outline centering
3. Standard tolerance of  $\pm 0.05$  mm is recommended.
4. 1.0 N placement force is recommended. Too much placement force can lead to squeezed out solder paste and cause solder joints to short. Too low placement force can lead to insufficient contact between package and solder paste that could cause open solder joints or badly centered packages.
5. To improve the package placement accuracy, a bottom side optical control should be performed with a high resolution tool.
6. For assembly, a perfect supporting of the PCB (all the more on flexible PCB) is recommended during solder paste printing, pick and place and reflow soldering by using optimized tools.

## 3.5 PCB design preference

1. To control the solder paste amount, the closed via is recommended instead of open vias.
2. The position of tracks and open vias in the solder area should be well balanced. A symmetrical layout is recommended, to avoid any tilt phenomena caused by asymmetrical solder paste due to solder flow away.

### 3.6 Reflow profile

Figure 17. ST ECOPACK recommended soldering reflow profile for PCB mounting

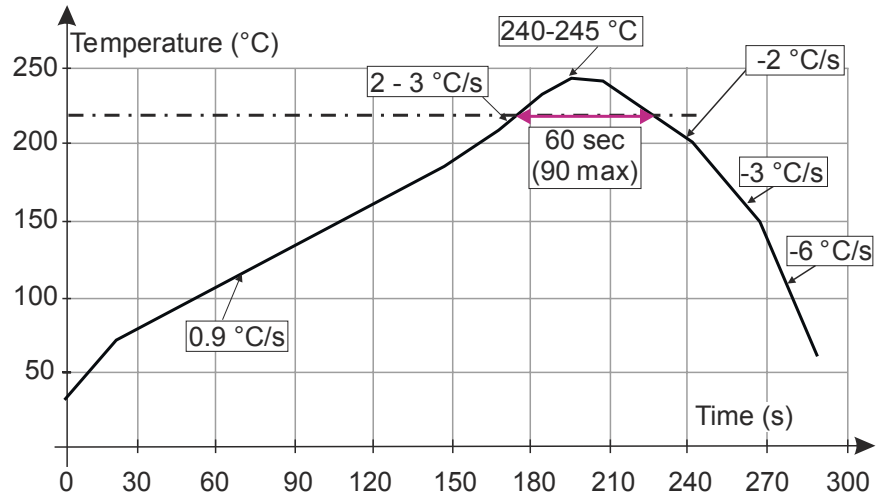

Note: Minimize air convection currents in the reflow oven to avoid component movement.

Note: More information is available in the application note:

- AN2348 Flip-Chip: "Package description and recommendations for use"

## 4 Ordering information

**Table 7. Ordering information**

Order code	Marking	Package	Weight	Base qty.	Delivery mode
MLPF-WB-02D3	TX	CSPG	1.82 mg	5000	Tape and reel

## Revision history

**Table 8. Document revision history**

Date	Revision	Changes
29-Jul-2022	1	Initial release.
25-Nov-2022	2	Updated <a href="#">Section 3.1</a> Land pattern.

**IMPORTANT NOTICE – READ CAREFULLY**

STMicroelectronics NV and its subsidiaries (“ST”) reserve the right to make changes, corrections, enhancements, modifications, and improvements to ST products and/or to this document at any time without notice. Purchasers should obtain the latest relevant information on ST products before placing orders. ST products are sold pursuant to ST’s terms and conditions of sale in place at the time of order acknowledgment.

Purchasers are solely responsible for the choice, selection, and use of ST products and ST assumes no liability for application assistance or the design of purchasers’ products.

No license, express or implied, to any intellectual property right is granted by ST herein.

Resale of ST products with provisions different from the information set forth herein shall void any warranty granted by ST for such product.

ST and the ST logo are trademarks of ST. For additional information about ST trademarks, refer to [www.st.com/trademarks](http://www.st.com/trademarks). All other product or service names are the property of their respective owners.

Information in this document supersedes and replaces information previously supplied in any prior versions of this document.

© 2022 STMicroelectronics – All rights reserved