

NEW!
Two & Three
Section Models

MMIC REFLECTIONLESS FILTERS

50Ω DC to 21 GHz

The Big Deal

- High Stopband rejection, up to 50 dB
- Patented design terminates stopband signals
- Pass band cut-off up to 11 GHz
- Stop band up to 26 GHz
- Excellent repeatability through IPD* process



X-Series

Available in Low Pass
& High Pass designs

Product Overview

Mini-Circuits' **X-Series** of reflectionless filters now includes 2- and 3-section models, giving you ultra-high rejection in the stopband – up to 50 dB! Reflectionless filters employ a patented filter topology which absorbs and terminates stopband signals internally rather than reflecting them back to the source. This new capability enables unique applications for filter circuits beyond those suited to traditional approaches. Traditional filters are reflective in the stopband, sending signals back to the source at 100% power. These reflections interact with neighboring components and often result in intermodulation and other interferences. By eliminating stopband reflections, reflectionless filters can readily be paired with sensitive devices and used in applications that otherwise require circuits such as isolation amplifiers or attenuators.

Key Features

Advantages

Easy integration with sensitive reflective components, e.g. mixers, multipliers	Reflectionless filters absorb unwanted signals falling in filter stopband, preventing reflections back to the source. This reduces generation of additional unwanted signals without the need for extra components like attenuators, improving system dynamic range and saving board space.
High stopband rejection, up to 50 dB	Ideal for applications where suppression of strong spurious signals and intermodulation products is needed.
Enables stable integration of wideband amplifiers	Because reflectionless filters maintain good impedance in the stopband; they can be integrated with high gain, wideband amplifiers without the risk of creating instabilities in these out of band regions.
Cascadable	Reflectionless filters can be cascaded in multiple sections to provide sharper and higher attenuation, while also preventing any standing waves that could affect passband signals. Low & highpass filters can be cascaded to realize bandpass filters.
Excellent power handling in a tiny surface mount device up to 7W in passband	High power handling extends the usability of these filters to the transmit path for inter-stage filtering.
Small size, 3x3mm/ 4x4 mm/ 5x5mm QFN	Allows replacement of filter/attenuator pairs with a single reflectionless filter, saving board space.
Excellent repeatability of RF performance	Through semiconductor IPD process, X-series filters are inherently repeatable for large volume production.
Excellent stability over temperature	With ±0.3 dB variation over temperature ideal for use in wide temperature range applications without the need for additional temperature compensation.
Operating temperature up to 105°C	Suitable for operation close to high power components.

*IPD – Integrated Passive Device, is a GaAs semiconductor process



Reflectionless Low Pass Filter

XLF-172H+

50Ω DC to 2000 MHz

Features

- Match to 50Ω in the stop band, eliminates undesired reflections
- Cascadable
- Excellent stopband rejection, 47 dB typ.
- Temperature stable, up to 105°C
- Small size, 4 x 4 mm
- Protected by US Patents 8,392,495; 9,705,467, additional patent pending
- Protected by China Patent 201080014266.1
- Protected by Taiwan Patent I581494

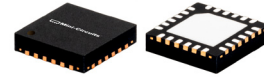

Generic photo used for illustration purposes only
CASE STYLE: DG1847

+RoHS Compliant

The +Suffix identifies RoHS Compliance. See our web site for RoHS Compliance methodologies and qualifications

Applications

- Cellular, PCS
- GPS
- Radio astronomy
- Telemetry

General Description

Mini-Circuits' XLF-172H+ three-section reflectionless filter employs a novel filter topology which absorbs and terminates stop band signals internally rather than reflecting them back to the source. This new capability enables unique applications for filter circuits beyond those suited to traditional approaches. Traditional filters are reflective in the stop band, sending signals back to the source at 100% of the power level. These reflections interact with neighboring components and often result in inter-modulation and other interferences. Reflectionless filters eliminate stop band reflections, allowing them to be paired with sensitive devices and used in applications that otherwise require circuits such as isolation amplifiers or attenuators.

simplified schematic and pad description

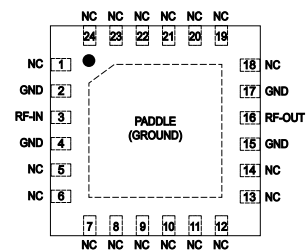
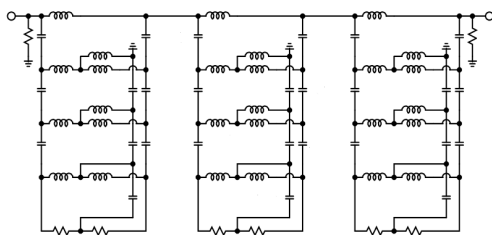

Function	Pad Number	Description
RF-IN	3	RF Input Pad
RF-OUT	16	RF Output Pad
GND	2,4,15,17 & paddle	Connected to ground
NC (GND Externally)	1, 5-14,18-24	No internal connection

Electrical Specifications¹ at 25°C

Parameter	F#	Frequency (MHz)	Min.	Typ.	Max.	Unit	
Pass Band	Insertion Loss	DC - F1	DC - 2000	—	1.7	3.0	dB
	Frequency Cut-off	F2	2350	—	3.0	—	
	VSWR	DC - F1	DC - 2000	—	1.3	—	:1
Stop Band	Rejection	F3 - F3'	3600 - 3800	16	28	—	dB
		F3' - F4	3800 - 11000	32	47	—	
		F4 - F5	11000 - 20000	—	46	—	
	VSWR	F3 - F3'	3600 - 3800	—	1.2	—	:1
		F3' - F4	3800 - 11000	—	1.4	—	
		F4 - F5	11000 - 20000	—	1.5	—	

¹ Measured on Mini-Circuits Characterization Test Board TB-952-172H+

Absolute Maximum Ratings⁴

Parameter	Ratings
Operating Temperature	-55°C to +105°C
Storage Temperature	-65°C to +150°C
RF Power Input, Passband (DC-F1) ²	7.9W at 25°C
RF Power Input, Stopband (F2-F5) ³	1.58W at 25°C

² Passband rating derates linearly to 3.9W at 105°C ambient

³ Stopband rating derates linearly to 0.75W at 105°C ambient

⁴ Permanent damage may occur if any of these limits are exceeded.

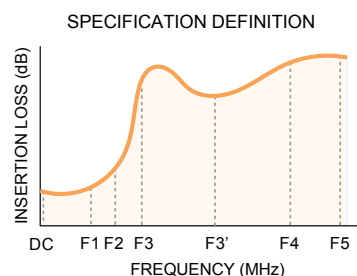

ESD rating

Human body model (HBM): Class 1A (Pass 250 V) in accordance with ANSI/ESD 5.1-2001

Typical Performance Data at 25°C

Frequency (MHz)	Insertion Loss (dB)	VSWR (:1)
10	1.15	1.16
100	1.16	1.16
500	1.30	1.26
1000	1.61	1.36
1500	1.98	1.32
2000	2.45	1.18
2350	2.99	1.12
3000	5.58	1.22
3600	20.35	1.21
3800	42.42	1.29
6000	36.18	1.60
8000	51.77	1.23
9000	65.37	1.18
10000	61.29	1.42
11000	55.48	1.77
12000	50.73	2.18
14000	47.75	2.72
15000	46.17	2.69
20000	50.12	2.79

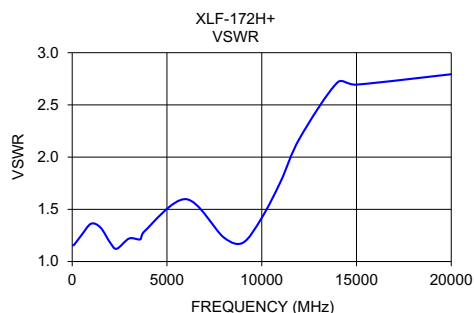
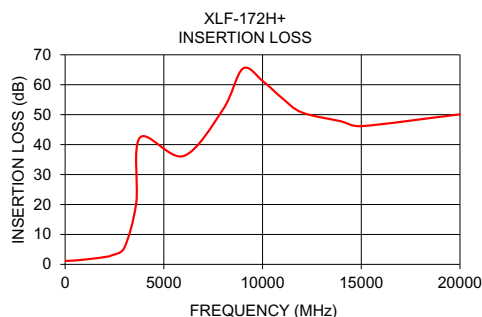

Outline Drawing

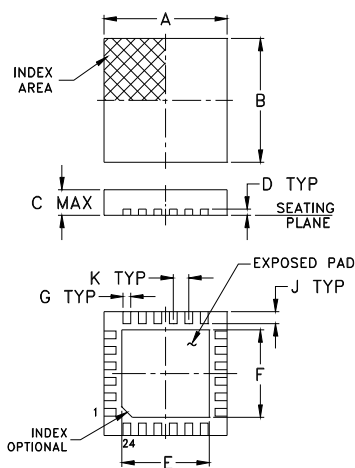

PCB Land Pattern

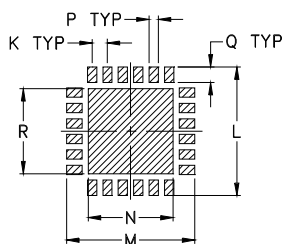

Suggested Layout,
Tolerance to be within ±.002

Demo Board MCL P/N: TB-952-172H+
Suggested PCB Layout: PL-519

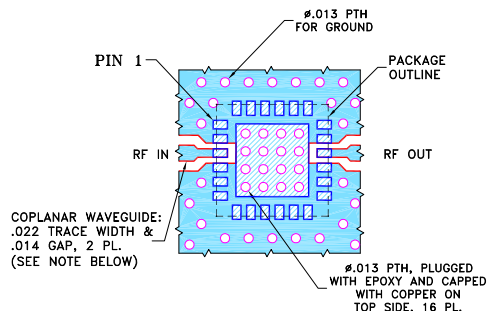

- NOTES:**
1. TRACE WIDTH & GAP ARE SHOWN FOR ROGERS R04350B WITH DIELECTRIC THICKNESS .010" ± .001"; COPPER: 1/2 OZ. EACH SIDE. FOR OTHER MATERIALS TRACE WIDTH MAY NEED TO BE MODIFIED.
 2. BOTTOM SIDE OF THE PCB IS CONTINUOUS GROUND PLANE.
- DENOTES PCB COPPER LAYOUT WITH SMOBC (SOLDER MASK OVER BARE COPPER)
 - DENOTES COPPER LAND PATTERN FREE OF SOLDER MASK

Outline Dimensions (inch / mm)

A	B	C	D	E	F	G	H	J
.157	.157	.039	.008	.104	.104	.009	--	.016
4.0	4.0	1.0	0.20	2.64	2.64	0.23	--	0.41
K	L	M	N	P	Q	R		wt
.020	.166	.166	.102	.012	.020	.102		grams
0.50	4.22	4.22	2.59	0.30	0.51	2.59		0.04

Tape & Reel Packaging, F68

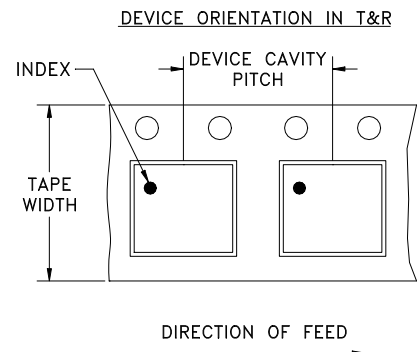

Product Marking

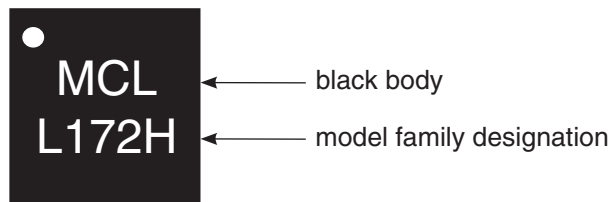

Tape Width, mm	Device Cavity Pitch, mm	Reel Size, inches	Devices per Reel see note
12	8	7	Small quantity standard
			20
			50
		13	Standard
			1000
			2000
			3000
			4000

Lead Finish: Matte-Tin

Application Circuit Example

Pairing mixers with reflectionless filters to improve system dynamic range

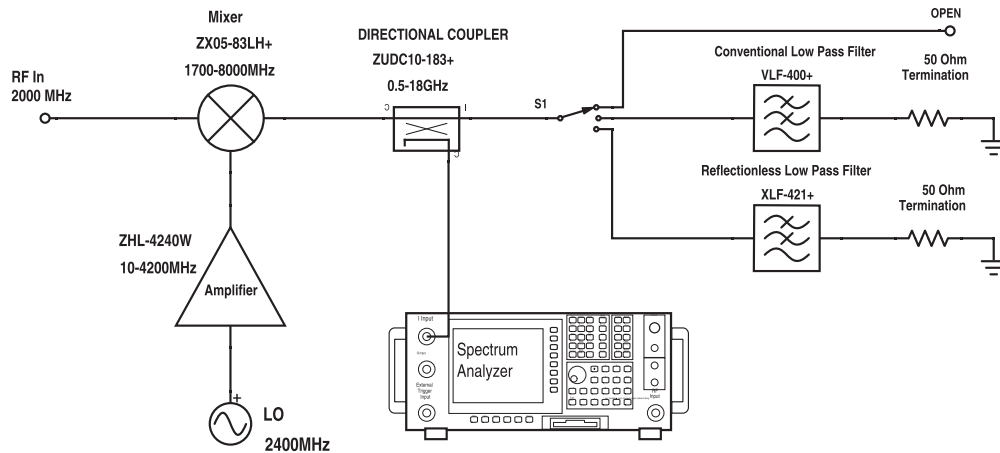

Test block diagram: IF output reflection spectrum with single input frequency

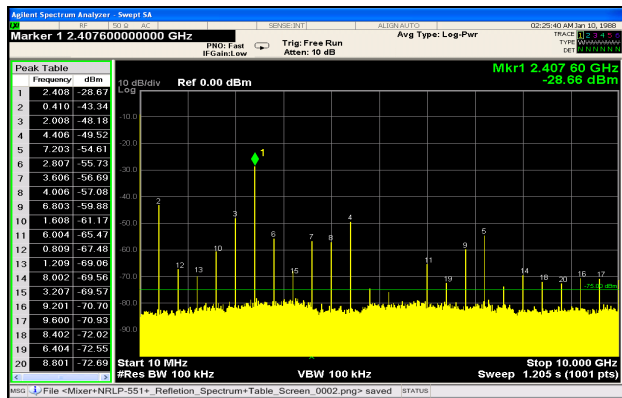

Figure 1. IF output reflection spectrum without filter

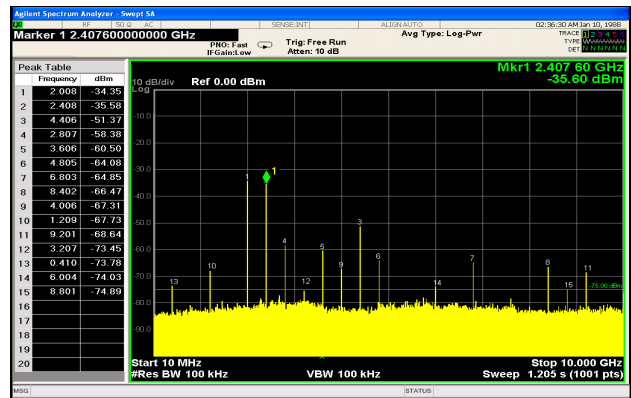

Figure 2. IF output reflection spectrum with conventional filter

An application circuit was assembled to measure the IF reflection spectrum at the output of a mixer when the mixer was paired with a conventional filter versus a reflectionless filter.

While the conventional filter reduces the reflections present when the mixer is used alone (no filter), the reflectionless filter virtually eliminates those reflections altogether.

The reflected signal at marker 1 in the figures above exhibits a reduction of more than 20 dB from -28.7 dBm to -50.3 dBm when the reflectionless filter is used as compared to the conventional filter, thus eliminating unwanted spurious mixing products and improving system dynamic range.

For more information, refer to application note [AN-75-007](#)

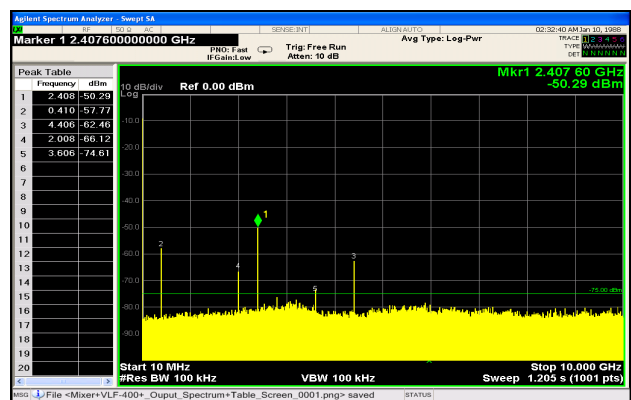

Figure 3. IF output reflection spectrum with reflectionless filter

Additional Notes

- Performance and quality attributes and conditions not expressly stated in this specification document are intended to be excluded and do not form a part of this specification document.
- Electrical specifications and performance data contained in this specification document are based on Mini-Circuits' applicable established test performance criteria and measurement instructions.
- The parts covered by this specification document are subject to Mini-Circuits standard limited warranty and terms and conditions (collectively, "Standard Terms"); Purchasers of this part are entitled to the rights and benefits contained therein. For a full statement of the Standard Terms and the exclusive rights and remedies thereunder, please visit Mini-Circuits' website at www.minicircuits.com/MCLStore/terms.jsp