

# Coaxial Bandpass Filter

## ZABP-550-S+

50Ω 100 to 1000 MHz

### The Big Deal

- High rejection
- Good VSWR
- Connectorized package



Generic photo used for illustration purposes only  
CASE STYLE: UU1842

### Product Overview

ZABP-550-S+ is a 50Ω bandpass filter with a rugged connectorized package covering the passband of 100 to 1000 MHz. The bandpass filter offers good matching within the passband and provides high rejection. This filter has miniature high Q capacitors and wire welded inductors for high reliability. It has repeatable performance across lots and consistent performance across temperature.

### Key Features

Feature	Advantages
High rejection	ZABP-550-S+ has sharper transition and rejects spurious signals in the stopband.
Good VSWR	This filter maintains typical VSWR over passband frequency range making this filter easier to integrate into receiver and transmitter RF chains with less concerns for in band frequency ripple.
Connectorized package	Connectorized package is easy to interface with other devices and well suited for test setups.

#### Notes

- A. Performance and quality attributes and conditions not expressly stated in this specification document are intended to be excluded and do not form a part of this specification document.  
B. Electrical specifications and performance data contained in this specification document are based on Mini-Circuit's applicable established test performance criteria and measurement instructions.  
C. The parts covered by this specification document are subject to Mini-Circuits standard limited warranty and terms and conditions (collectively, "Standard Terms"); Purchasers of this part are entitled to the rights and benefits contained therein. For a full statement of the Standard Terms and the exclusive rights and remedies thereunder, please visit Mini-Circuits' website at [www.minicircuits.com/MCLStore/terms.jsp](http://www.minicircuits.com/MCLStore/terms.jsp)



# Bandpass Filter

## ZABP-550-S+

50Ω 100 to 1000 MHz



Generic photo used for illustration purposes only

CASE STYLE: UU1842  
Connectors Model  
SMA-MF ZABP-550-S+

### Features

- Sharp roll-off
- Ultra wide bandwidth
- Good VSWR
- Connectorized package

### Applications

- Receiver front end applications
- Cellular network
- Civil aircraft communication radio
- Test equipment

### Functional Schematic

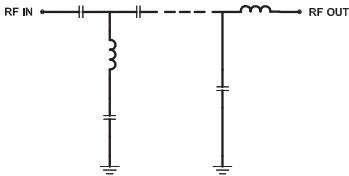

### Typical Frequency Response

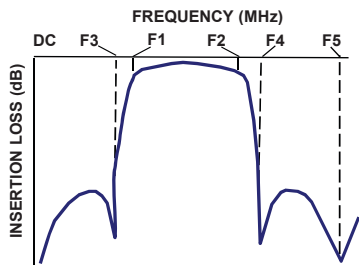

**+RoHS Compliant**  
The +Suffix identifies RoHS Compliance. See our web site for RoHS Compliance methodologies and qualifications

### Electrical Specifications at 25°C

Parameter	F#	Frequency (MHz)	Min.	Typ.	Max.	Unit
Pass Band	Center Frequency	-	-	550	-	MHz
	Insertion Loss	F1-F2	100-1000	1.1	2.2	dB
	VSWR	F1-F2	100-1000	1.5	2.1	:1
Stop Band, Lower	Insertion Loss	DC-F3	DC - 80	40	50	dB
	VSWR	DC-F3	DC - 80	-	20	:1
Stop Band, Upper	Insertion Loss	F4-F5	1200-2000	30	40	dB
	VSWR	F4-F5	1200-2000	-	20	:1

### Maximum Ratings

Operating Temperature	-40°C to 85°C
Storage Temperature	-55°C to 100°C
RF Power Input	1 W max.

Permanent damage may occur if any of these limits are exceeded.

### Typical Performance Data at 25°C

Frequency (MHz)	Insertion Loss (dB)	VSWR (:1)	Frequency (MHz)	Group Delay (ns)
1	99.59	46461.03	100	31.04
25	69.03	2049.79	125	9.40
50	67.70	281.03	150	4.99
80	51.48	26.64	200	3.65
83	48.25	18.10	250	2.55
85	32.84	13.50	300	2.05
88	20.37	8.96	350	1.79
90	11.15	5.66	400	1.64
94	3.48	2.54	450	1.54
100	1.23	1.24	500	1.49
550	0.47	1.33	550	1.47
1000	0.95	1.16	600	1.48
1090	3.70	2.11	650	1.50
1110	9.66	5.46	700	1.55
1125	16.25	8.77	750	1.60
1133	20.18	10.25	800	1.69
1151	30.32	12.61	850	1.82
1200	50.19	16.16	900	2.02
1600	52.37	20.19	950	2.25
2000	42.64	21.45	1000	2.95

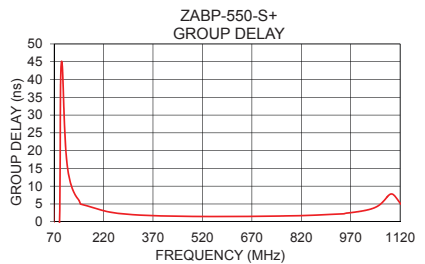
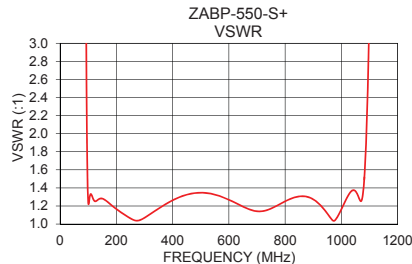
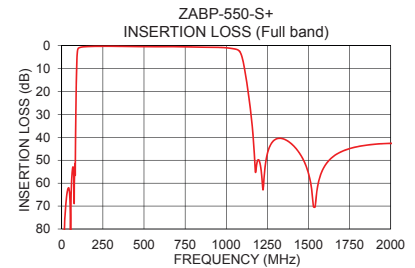
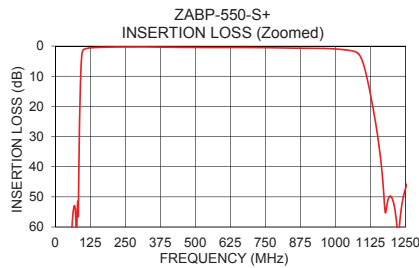

### Notes

- Performance and quality attributes and conditions not expressly stated in this specification document are intended to be excluded and do not form a part of this specification document.
- Electrical specifications and performance data contained in this specification document are based on Mini-Circuits' applicable established test performance criteria and measurement instructions.
- The parts covered by this specification document are subject to Mini-Circuits standard limited warranty and terms and conditions (collectively, "Standard Terms"); Purchasers of this part are entitled to the rights and benefits contained therein. For a full statement of the Standard Terms and the exclusive rights and remedies thereunder, please visit Mini-Circuits' website at [www.minicircuits.com/MCLStore/terms.jsp](http://www.minicircuits.com/MCLStore/terms.jsp)



## Coaxial Connections

PORT - 1	SMA-MALE
PORT - 2	SMA-FEMALE

## Outline Drawing

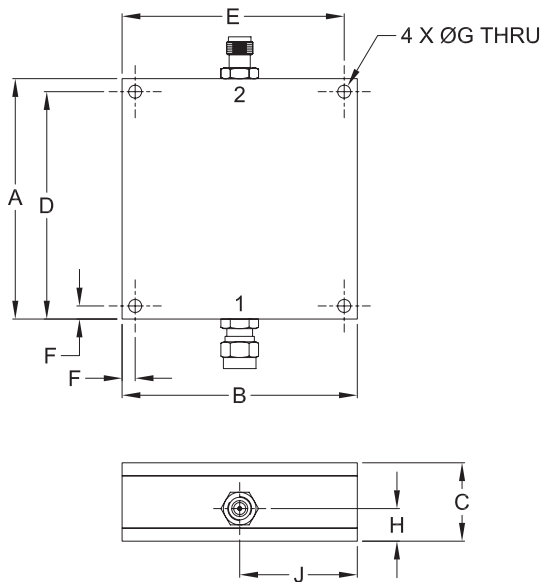

## Outline Dimensions ( $\frac{\text{inch}}{\text{mm}}$ )

A	B	C	D	E
2.300	2.250	.750	2.175	2.125
58.42	57.15	19.05	55.25	53.98
F	G	H	J	wt.
.125	.125	.312	1.125	grams
3.18	3.18	7.93	28.58	124

Note: Please refer to case style drawing for details

### Notes

- A. Performance and quality attributes and conditions not expressly stated in this specification document are intended to be excluded and do not form a part of this specification document.
- B. Electrical specifications and performance data contained in this specification document are based on Mini-Circuit's applicable established test performance criteria and measurement instructions.
- C. The parts covered by this specification document are subject to Mini-Circuits standard limited warranty and terms and conditions (collectively, "Standard Terms"); Purchasers of this part are entitled to the rights and benefits contained therein. For a full statement of the Standard Terms and the exclusive rights and remedies thereunder, please visit Mini-Circuits' website at [www.minicircuits.com/MCLStore/terms.jsp](http://www.minicircuits.com/MCLStore/terms.jsp)

