

UWB: 6.24 – 8.24 GHz SMD LTCC Filter



ABSGS4C7-CDGM3B8M

Request Samples



Check Inventory



2.00 x 1.25 x 0.95mm
RoHS Compliant
MSL Level = 1

Features

- Wide Band BPF
- Low loss of 2.5 dB
- Compact package size
- Max power rating of 3W
- Group delay < 2 ns

Applications

- UWB (Ultra-Wide Band)
- IoT
- M2M
- Secure car access
- Item Tracking
- Indoor Navigation
- Hands-Free Payment
- Smart Access
- Object Detection

Product Image



UWB: 6.24 – 8.24 GHz SMD LTCC Filter



ABSGS4C7-CDGM3B8M

Request Samples



Check Inventory



2.00 x 1.25 x 0.95mm
RoHS Compliant
MSL Level = 1

Electrical Specifications

| Parameter | Min | Typical | Max | Unit | Notes |
|--------------------|-------|---------|---------------------------------|------|--|
| Frequency Range | 6240 | ----- | 8240 | MHz | ----- |
| Insertion Loss | ----- | ----- | -2.7 | dB | ----- |
| Return Loss | ----- | ----- | -10 | dB | ----- |
| Group Delay Ripple | ----- | ----- | 1.0 | ns | ----- |
| Group Delay | ----- | ----- | 3.0 | ns | ----- |
| Attenuation | ----- | ----- | -35 -35 -15 -10 -30 | dB | DC ~ 5200 MHz 2400 ~ 2500 MHz 5200 ~ 5860 MHz 9000 ~ 9500 MHz 9500 ~ 18000 MHz |
| Power Capacity | ----- | ----- | 3 | W | ----- |

Mechanical Specifications

| Parameters | Specifications |
|---------------------|-----------------------|
| Filter Dimension | 2.00 x 1.25 x 0.95 mm |
| Mounting Type | SMD Mount |
| Material Type | Dielectric Filter |
| Technology | LTCC |
| In/Output Terminals | Ag + Ni + Sn |
| Ground Base | Ag+ Ni + Sn |

Environmental Specifications

| Parameters | Specifications |
|-----------------------------|-------------------|
| Operating Temperature Range | -40°C ~ +105 °C |
| Storage Temperature Range | -40°C ~ +105 °C |
| MSL level | 1 |
| ESD | N/A |
| Temperature range | 25±5 °C |
| Relative Humidity range | 90~95%RH & <85%RH |



5101 Hidden Creek Ln Spicewood TX 78669
Phone: 512-371-6159 | Fax: 512-351-8858
For terms and conditions of sales, please visit:
www.abracon.com

REVISED: 09-23-22

ABRACON IS
ISO9001-2015
CERTIFIED

UWB: 6.24 – 8.24 GHz SMD LTCC Filter



ABSGS4C7-CDGM3B8M

Request Samples



Check Inventory



2.00 x 1.25 x 0.95mm
RoHS Compliant
 MSL Level = 1

Package Dimensions

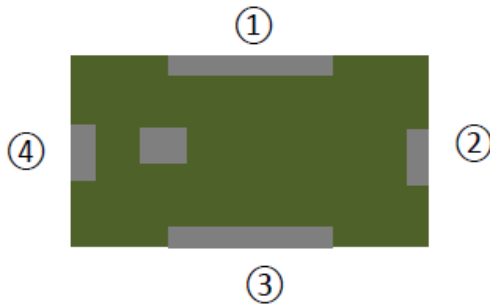

| Number | Terminal Name |
|--------|---------------|
| ① | GND |
| ② | OUT |
| ③ | GND |
| ④ | IN |

(Top View)

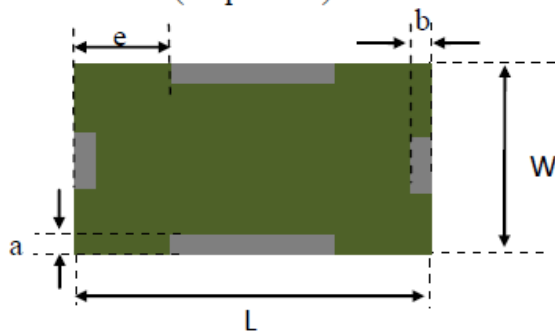

(Bottom View)

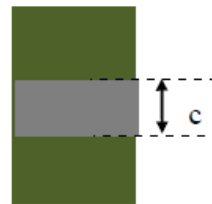

(Side View)

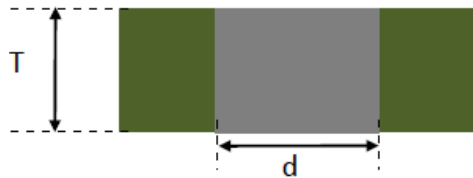

(Side View)

| Symbol | L | W | T | a | b | c | d | e |
|----------------|----------|-----------|-----------|-----------|----------|----------|----------|-----------|
| Dimension (mm) | 2.0±0.15 | 1.25±0.10 | 0.95±0.10 | 0.25±0.10 | 0.25±0.1 | 0.3±0.10 | 1.3±0.10 | 0.35±0.10 |

UWB: 6.24 – 8.24 GHz SMD LTCC Filter



ABSGS4C7-CDGM3B8M

Request Samples



Check Inventory



2.00 x 1.25 x 0.95mm
RoHS Compliant
MSL Level = 1

Footprint

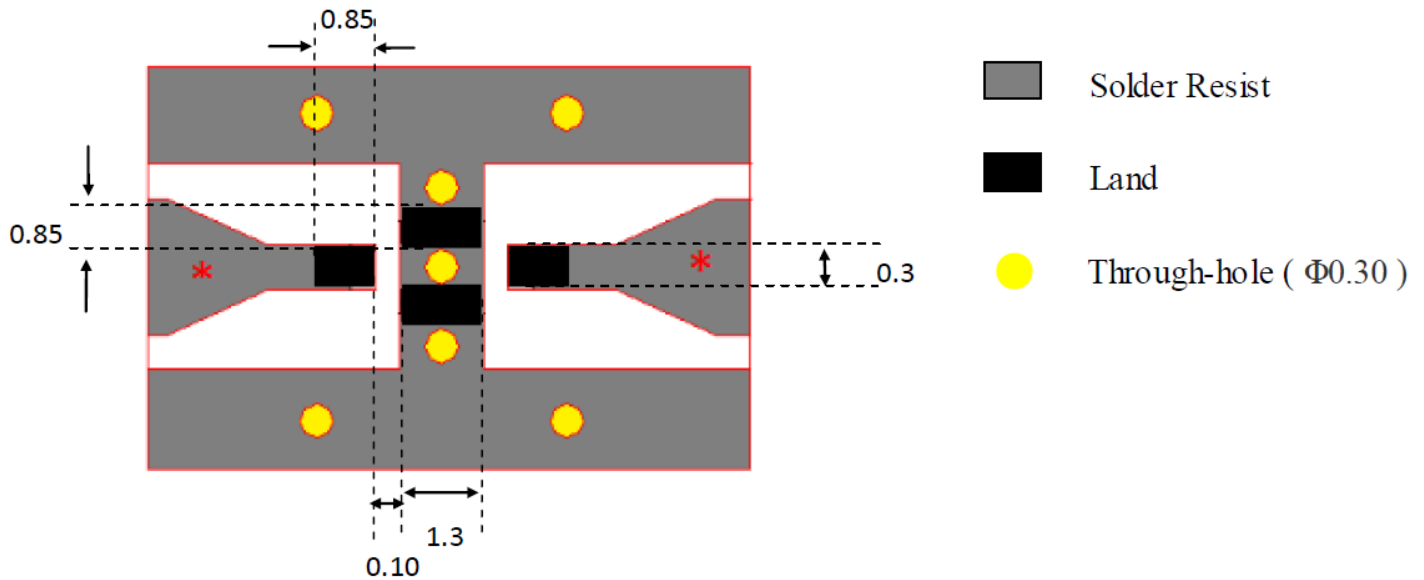

*Note: Line Width Should be designed to match 50Ω characteristic impedance, depending on PCB material and thickness

Unit: mm

UWB: 6.24 – 8.24 GHz SMD LTCC Filter



ABSGS4C7-CDGM3B8M

Request Samples



Check Inventory



2.00 x 1.25 x 0.95mm
RoHS Compliant
MSL Level = 1

Impedance Characteristics [Narrowband]

S-parameters

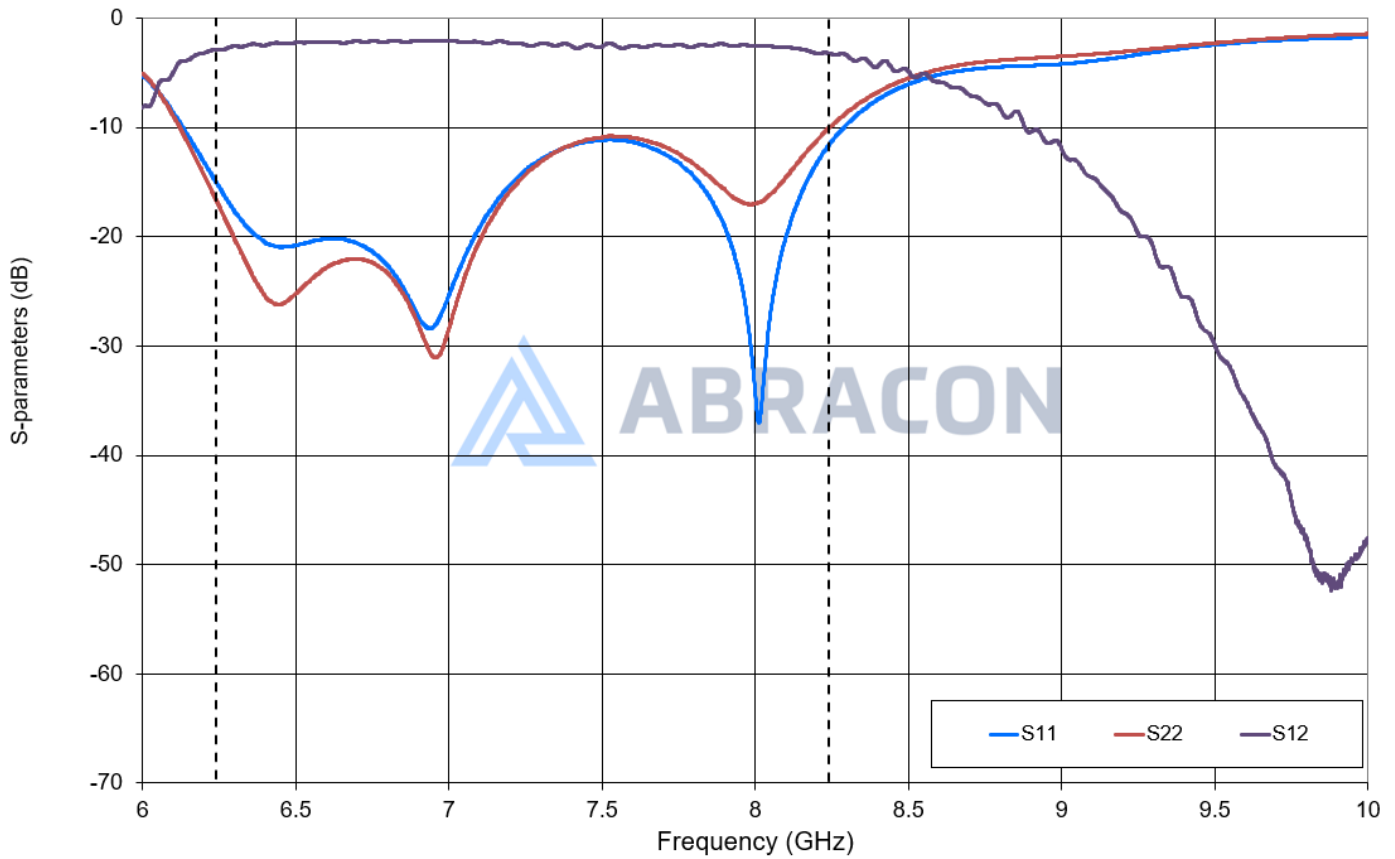

UWB: 6.24 – 8.24 GHz SMD LTCC Filter



ABSGS4C7-CDGM3B8M

Request Samples



Check Inventory



2.00 x 1.25 x 0.95mm
RoHS Compliant
MSL Level = 1

Impedance Characteristics [Wideband]

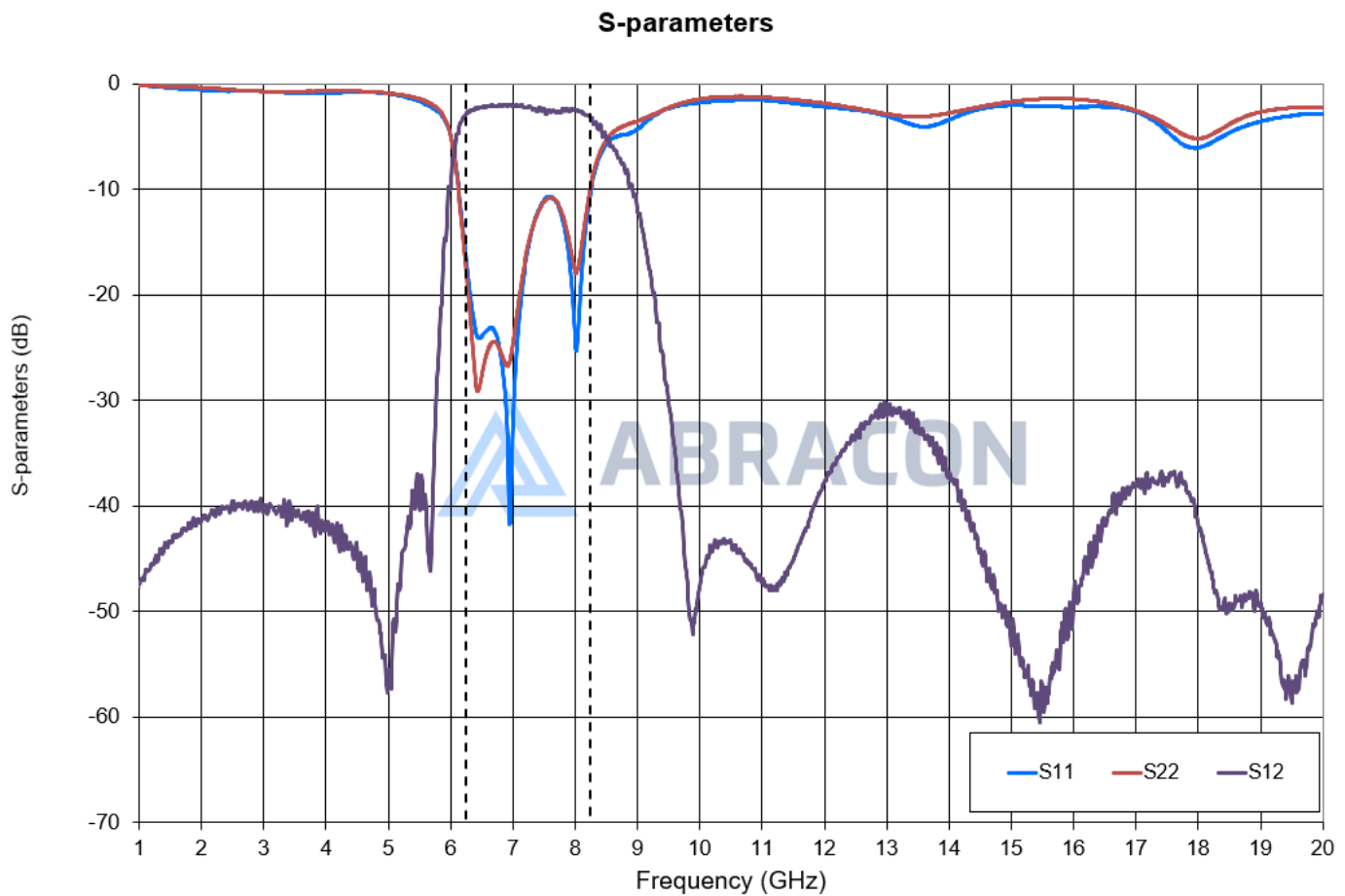

UWB: 6.24 – 8.24 GHz SMD LTCC Filter



ABSGS4C7-CDGM3B8M

Request Samples



Check Inventory



2.00 x 1.25 x 0.95mm
RoHS Compliant
MSL Level = 1

Group Delay Characteristics [Narrowband]

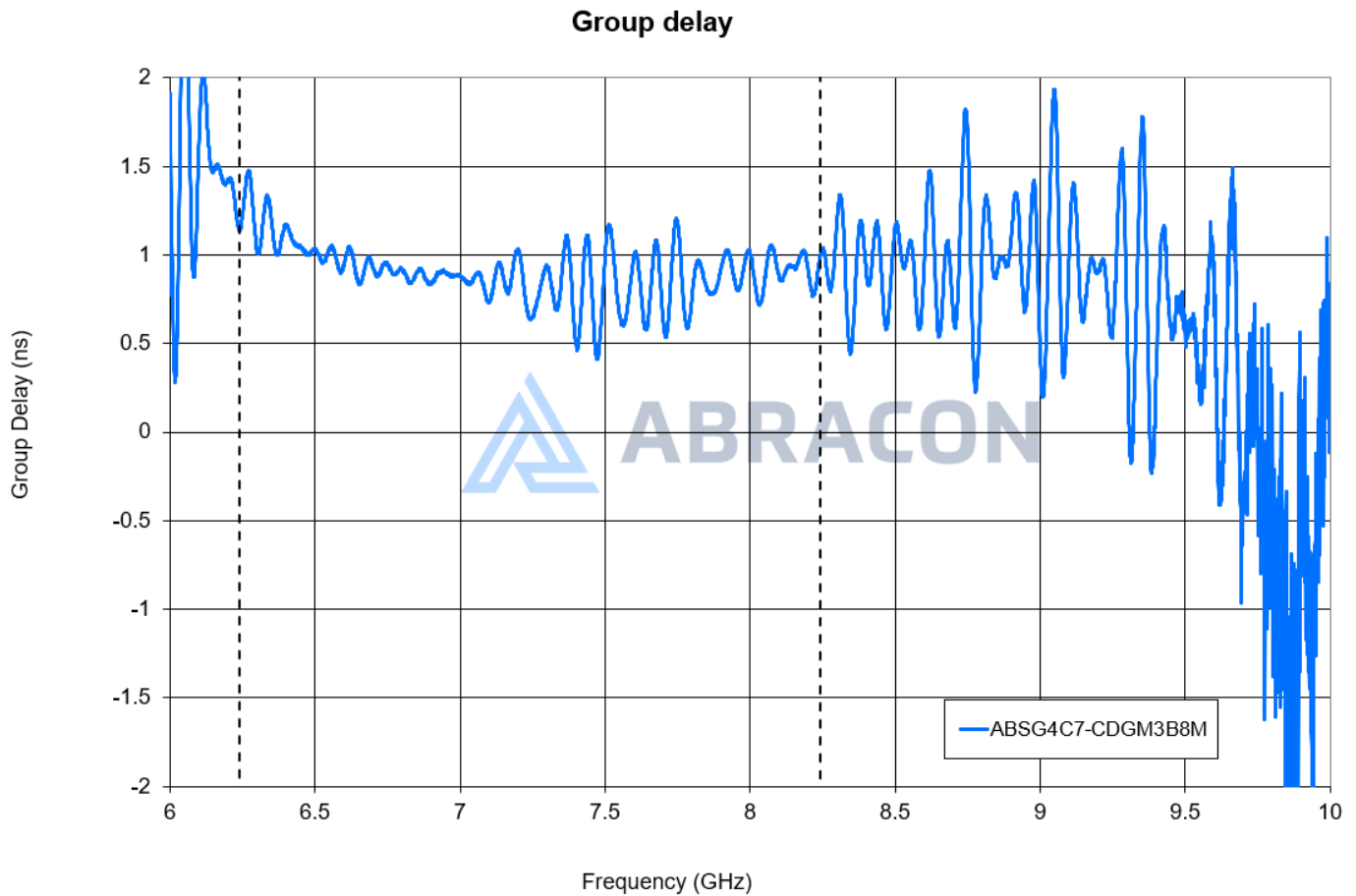

UWB: 6.24 – 8.24 GHz SMD LTCC Filter



ABSGS4C7-CDGM3B8M

Request Samples



Check Inventory



2.00 x 1.25 x 0.95mm
RoHS Compliant
MSL Level = 1

Group Delay Characteristics [Wideband]

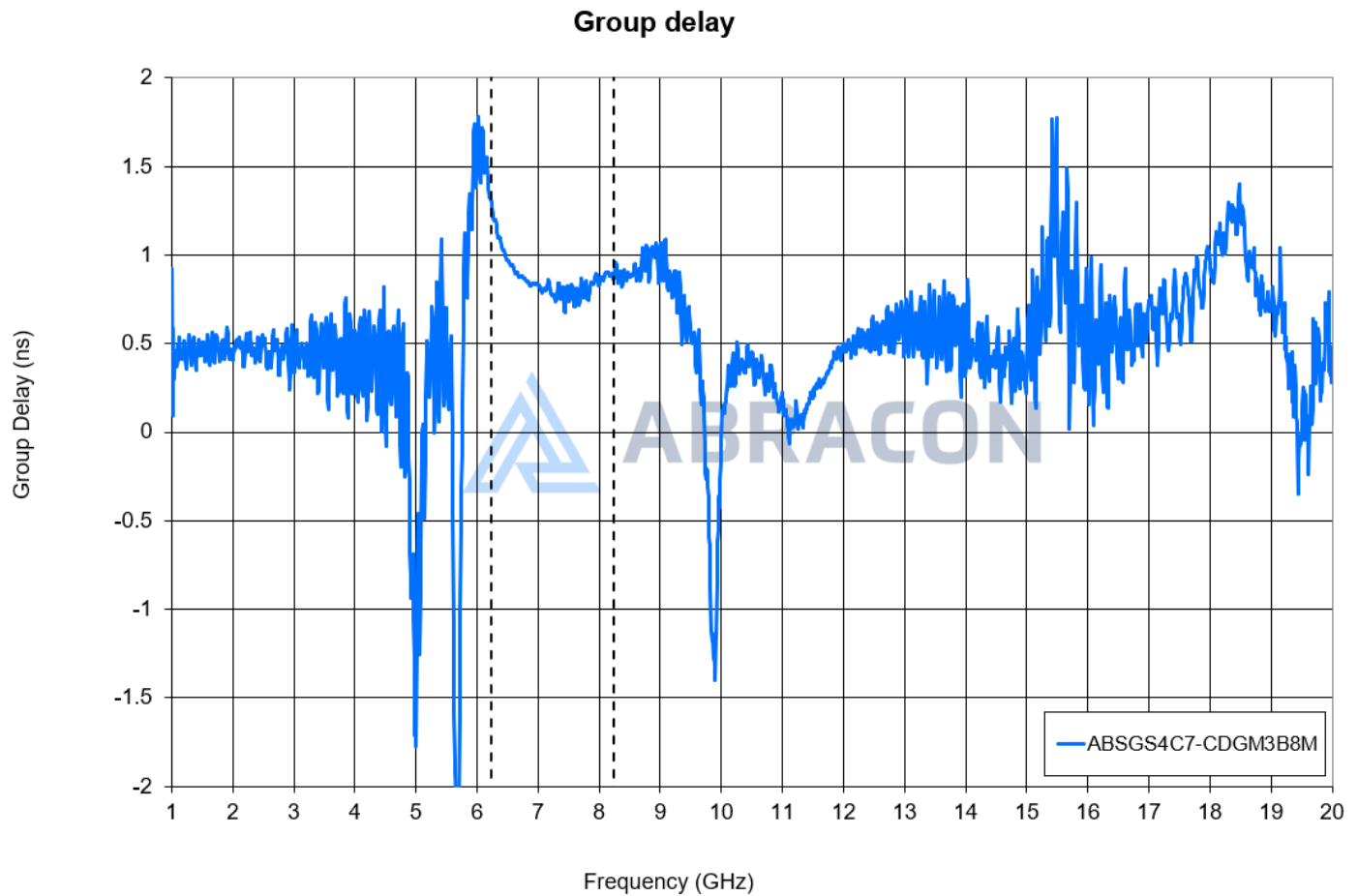

UWB: 6.24 – 8.24 GHz SMD LTCC Filter



ABSGS4C7-CDGM3B8M

Request Samples



Check Inventory



2.00 x 1.25 x 0.95mm
RoHS Compliant
 MSL Level = 1

Soldering Profile: Reflow

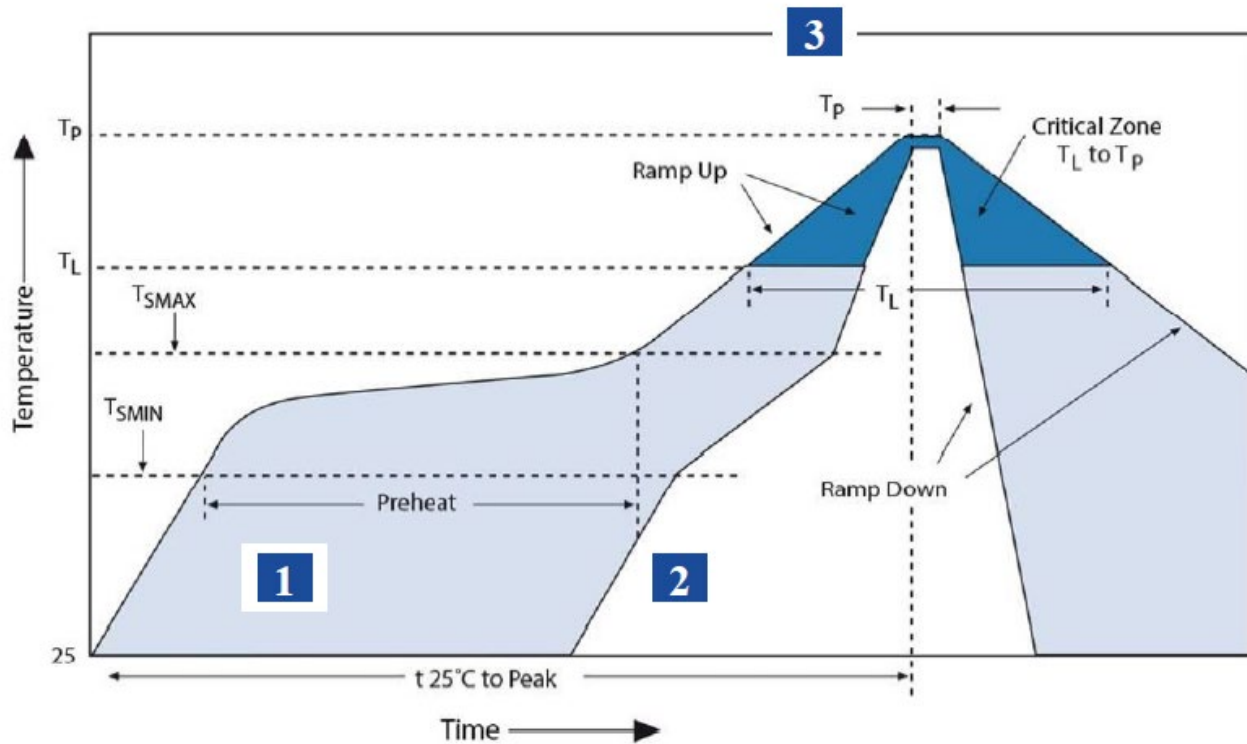

| Zone | Description | Temperature | Time |
|------|----------------|--|--------------|
| 1 | Preheat / Soak | $T_{SMIN} \sim T_{SMAX}$ 160 – 180 °C | 60 ~ 120 sec |
| 2 | Reflow | T_L 220 °C | 30~40 sec |
| 3 | Peak heat | T_P 265 °C | 5 sec (Max) |

UWB: 6.24 – 8.24 GHz SMD LTCC Filter



ABSGS4C7-CDGM3B8M

Request Samples



Check Inventory



2.00 x 1.25 x 0.95mm
RoHS Compliant
MSL Level = 1

Packaging and Dimensions

1. Plastic Tape

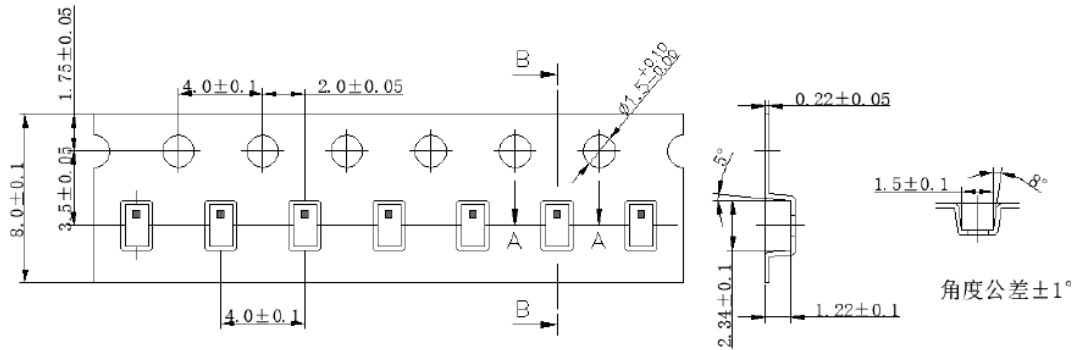

Reserve a length of 200mm for the trailer of the carrier and 200 mm for the leader of the carrier and further 200mm at least of cover tape at the leading part of the carrier.

2. Reel (4000 pcs/Reel)

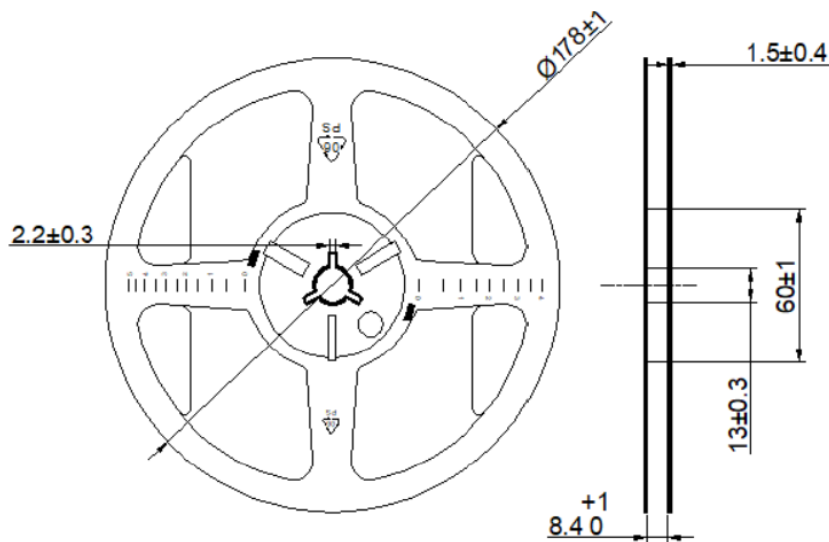

ATTENTION: Abracon LLC's products are COTS – Commercial-Off-The-Shelf products; suitable for Commercial, Industrial and, where designated, Automotive Applications. Abracon's products are not specifically designed for Military, Aviation, Aerospace, Life-dependent Medical applications or any application requiring high reliability where component failure could result in loss of life and/or property. For applications requiring high reliability and/or presenting an extreme operating environment, written consent and authorization from Abracon LLC is required. Please contact Abracon LLC for more information.



5101 Hidden Creek Ln Spicewood TX 78669
Phone: 512-371-6159 | Fax: 512-351-8858
For terms and conditions of sales, please visit:
www.abracon.com

REVISED: 09-23-22

ABRACON IS
ISO9001-2015
CERTIFIED