

# Surface Mount Bandpass Filter

## BPF-C587+

50Ω 470 to 705 MHz



Generic photo used for illustration purposes only  
CASE STYLE: HU1186

### The Big Deal

- Sharp roll-off
- Flatness 1.0 dB typical over the passband
- Wide bandwidth
- Good VSWR
- Miniature shielded package

### Product Overview

The BPF-C587+ is a wide band filter in a small shielded package (size of 0.87" x 0.80" x 0.25") fabricated using SMT technology. This filter offers sharp roll-off and rejection of 25 dB Typ. for use in HDTV broadcasting.

### Key Features

Feature	Advantages
Sharp roll-off	Provides good rejection of signals close to passband for improved systems performance.
Good VSWR	This filter maintains typical VSWR over passband frequency range making this filter easier to integrate into receiver and transmitter RF chains with less concerns for in band frequency ripple.
Flatness 1.0 dB typical	Better flatness over the full HDTV broadcasting band ( 420-705 MHz) making this ideal for use in applications where flatness and repeatability are critical performance requirements.
Metal SMT Shielded case.	Reduced interference to, and from surrounding components.

#### Notes

- A. Performance and quality attributes and conditions not expressly stated in this specification document are intended to be excluded and do not form a part of this specification document.  
B. Electrical specifications and performance data contained in this specification document are based on Mini-Circuit's applicable established test performance criteria and measurement instructions.  
C. The parts covered by this specification document are subject to Mini-Circuits standard limited warranty and terms and conditions (collectively, "Standard Terms"); Purchasers of this part are entitled to the rights and benefits contained therein. For a full statement of the Standard Terms and the exclusive rights and remedies thereunder, please visit Mini-Circuits' website at [www.minicircuits.com/MCLStore/terms.jsp](http://www.minicircuits.com/MCLStore/terms.jsp)



# Surface Mount Bandpass Filter

50Ω 470 to 705 MHz

## BPF-C587+



Generic photo used for illustration purposes only  
CASE STYLE: HU1186

### Features

- Sharp roll-off
- Wide bandwidth
- Good VSWR
- Miniature shielded package

### Applications

- Harmonic rejection
- TV Broadcasting / HDTV
- Transmitters / Receivers

### Electrical Specifications at 25°C

Parameter		F#	Frequency (MHz)	Min.	Typ.	Max.	Unit
Pass Band	Center Frequency	—	—	—	587	—	MHz
	Insertion Loss	F1-F2	470-705	—	2.0	2.5	dB
	Flatness	F1-F2	470-705	—	1.0	1.5	dB
	VSWR	F1-F2	470-705	—	1.7	1.9	:1
Stop Band, Lower	Insertion Loss	DC-F3	DC-400	25	30	—	dB
	VSWR	DC-F3	DC-400	—	20	—	:1
Stop Band, Upper	Insertion Loss	F4-F5	800-1500	20	25	—	dB
	VSWR	F4-F5	800-1500	—	20	—	:1

### Maximum Ratings

Operating Temperature	-40°C to 85°C
Storage Temperature	-55°C to 100°C
RF Power Input	1 W

Permanent damage may occur if any of these limits are exceeded.

### Functional Schematic

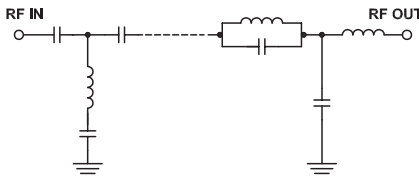

### Typical Frequency Response

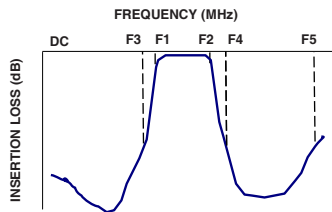

### Typical Performance Data at 25°C

Frequency (MHz)	Insertion Loss (dB)	VSWR (:1)	Frequency (MHz)	Group Delay (nsec)
1	102.01	352.40	470	13.22
50	83.87	442.67	480	9.11
200	55.72	190.60	490	7.17
400	33.32	37.80	500	6.03
446	22.17	7.15	510	5.32
448	16.82	5.41	520	4.83
450	12.33	3.84	530	4.45
458	3.43	1.16	540	4.16
470	1.61	1.30	550	3.92
587	0.67	1.17	587	3.44
705	0.99	1.25	600	3.38
720	1.34	1.54	620	3.34
740	2.99	2.74	640	3.35
760	7.69	5.64	650	3.39
784	19.87	9.56	660	3.46
794	29.43	10.86	670	3.58
800	37.59	11.63	680	3.76
1000	34.39	29.94	690	4.01
1250	30.20	36.43	700	4.34
1500	31.49	32.24	705	4.55

### +RoHS Compliant

The +Suffix identifies RoHS Compliance. See our web site for RoHS Compliance methodologies and qualifications

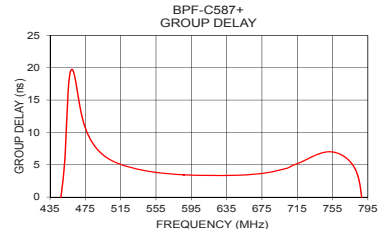
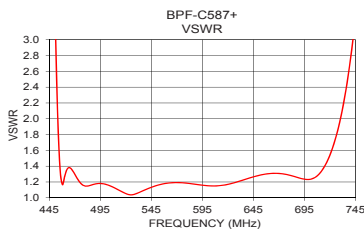
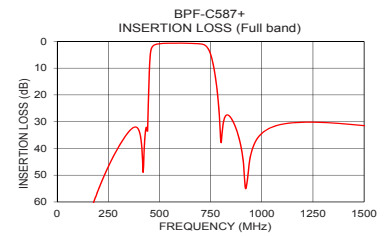
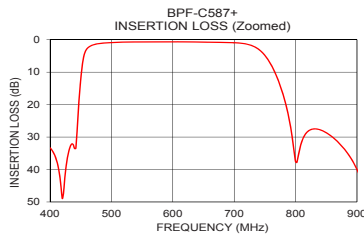

### Notes

- Performance and quality attributes and conditions not expressly stated in this specification document are intended to be excluded and do not form a part of this specification document.
- Electrical specifications and performance data contained in this specification document are based on Mini-Circuit's applicable established test performance criteria and measurement instructions.
- The parts covered by this specification document are subject to Mini-Circuits standard limited warranty and terms and conditions (collectively, "Standard Terms"); Purchasers of this part are entitled to the rights and benefits contained therein. For a full statement of the Standard Terms and the exclusive rights and remedies thereunder, please visit Mini-Circuits' website at [www.minicircuits.com/MCLStore/terms.jsp](http://www.minicircuits.com/MCLStore/terms.jsp)



[www.minicircuits.com](http://www.minicircuits.com) P.O. Box 350166, Brooklyn, NY 11235-0003 (718) 934-4500 sales@minicircuits.com

REV. A  
M174392  
BPF-C587+  
EDU2460/1  
URJ  
190824  
Page 2 of 3

## Pad Connections

INPUT	2
OUTPUT	9
GROUND	1,3,4,5,7,8,10,11,12,14
NOT CONNECTED	6,13

**Demo Board MCL P/N: TB-500+**  
**Suggested PCB Layout (PL-294)**

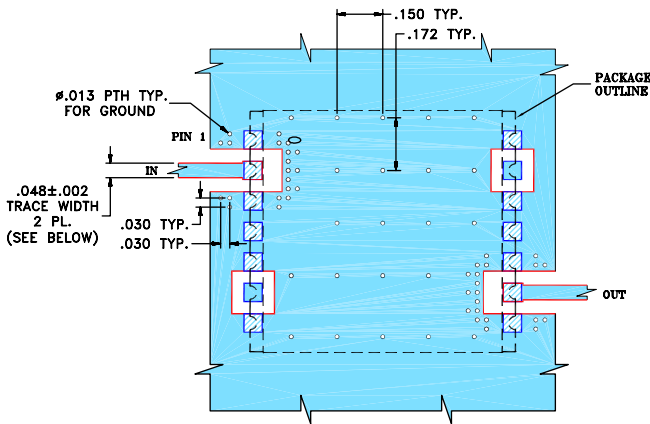

**NOTES:**

1. TRACE WIDTH IS SHOWN FOR ROGERS R04350B, DIELECTRIC THICKNESS: .030" ± .002"; COPPER: 1/2 OZ ON EACH SIDE. FOR OTHER MATERIALS TRACE WIDTH MAY NEED TO BE MODIFIED.
2. BOTTOM SIDE OF THE PCB IS CONTINUOUS GROUND PLANE.

DENOTES PCB COPPER LAYOUT WITH SMOBC (SOLDER MASK OVER BARE COPPER)

## Outline Drawing

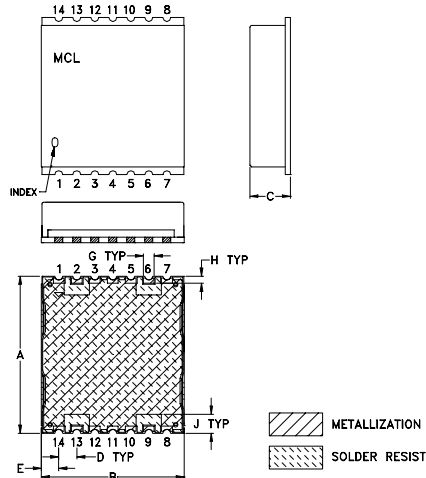

## PCB Land Pattern

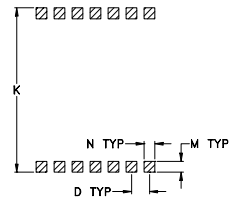

Suggested Layout,  
 Tolerance to be within ±.002

## Outline Dimensions (inch/mm)

A	B	C	D	E	F	G	H
.870	.800	.25	.100	.097	--	.060	.040
22.10	20.32	6.35	2.54	2.46	--	1.52	1.02
J	K	L	M	N	P	wt	
.105	.910	--	.060	.060	--	grams	
2.67	23.11	--	1.52	1.52	--	2.85	

Note: Please refer to case style drawing for details

**Notes**

- A. Performance and quality attributes and conditions not expressly stated in this specification document are intended to be excluded and do not form a part of this specification document.
- B. Electrical specifications and performance data contained in this specification document are based on Mini-Circuit's applicable established test performance criteria and measurement instructions.
- C. The parts covered by this specification document are subject to Mini-Circuits standard limited warranty and terms and conditions (collectively, "Standard Terms"); Purchasers of this part are entitled to the rights and benefits contained therein. For a full statement of the Standard Terms and the exclusive rights and remedies thereunder, please visit Mini-Circuits' website at [www.minicircuits.com/MCLStore/terms.jsp](http://www.minicircuits.com/MCLStore/terms.jsp)