

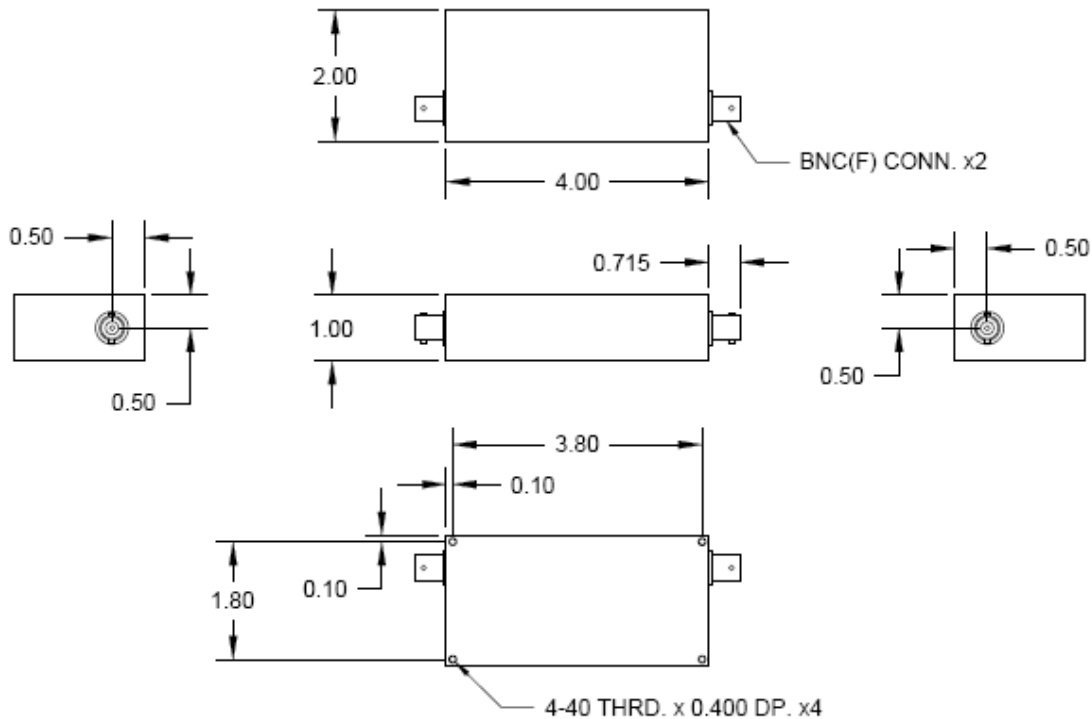

5 MHz Bandpass Filter

P/N: AE5B10717

Center Frequency:	5 MHz
Nominal 3 dB BW:	96,000
1 dB BW:	67,200 Hz min
40 dB to 3 dB Shape Factor:	2.0:1
Nominal 40 dB BW:	192000
VSWR:	1.5:1 max
P-P Ripple in 1 dB BW:	0.5 dB
Suppression in the 0-20 MHz Band outside filters 40 dB BW:	40 dB
Input/Output Impedance:	50 Ohms
I/O Connectors:	BNC (F)
Max Input Power:	0.5 W
Max Insertion Loss:	10 dB
Operating Temperature Range:	15°C to 40°C
Shock:	1G
Vibration:	1G





5 MHz Bandpass Filter

P/N: AE5B10717

