

CMX SERIES

PCB MOUNT



Features

- SIP SSR
- Ratings to 20A @ 60 VDC, 10A @ 100 VDC, 10A @ 60 VDC and 3A @ 200 VDC
- MOSFET output
- DC control
- Low on-state impedance
- CE Compliant to EN60950-1

PRODUCT SELECTION

Control Voltage	3 A	5 A	6 A	10 A	10 A	20 A
3-10 VDC	CMX200D3	CMX60D5	CMX100D6	CMX60D10	CMX100D10	CMX60D20
20-28 VDC	CMXE200D3	CMXE60D5	CMX100D6	CMX60D10	CMX100D10	CMX60D20

OUTPUT SPECIFICATIONS (1)(5)

Description	3 A	5 A	6 A	10 A	10 A	20 A
Operating Voltage [VDC]	0-200	0-60	0-100	0-60	0-100	0-60
Maximum Off-State Leakage Current @ Rated Voltage [μ Adc]	100	100	100	100 (6)	100	100
Maximum Load Current [ADC]	3	5	6	10	10	20
Minimum Load Current [mADC]	2	2	2	2	2	2
Maximum On-State Resistance [Ohm] (2)	0.20	.10	.040	.018	.010	.0033
Maximum Surge Current (10msec) [Apk]	30	60	100	100	100	200
Maximum On-State Voltage Drop @ Rated Current [VDC]	0.6	0.5	0.24	0.18	0.1	0.1

INPUT SPECIFICATIONS (1)

Description	CMX	CMXE
Control Voltage Range	3.0-10.0 VDC	20-28 VDC
Maximum Turn On Voltage	3.0 VDC	20 VDC
Minimum Turn-Off Voltage	1.0 VDC	1.0 VDC
Typical Input Current	15 mAdc @ 5 VDC	12 mAdc @ 24 VDC
Nominal Input Impedance	300 Ohm	780 Ohm
Maximum Turn-On Time [msec]	1.0	1.0
Maximum Turn-Off Time [μ sec]	300	300

GENERAL SPECIFICATIONS

Description	Parameters
Dielectric Strength, Input/Output (50/60Hz) (3)	2500 Vrms
Minimum Insulation Resistance (@ 500 VDC) (3)	10 ⁹ Ohms
Maximum Capacitance, Input/Output	15 pF
Ambient Operating Temperature Range (4)	-10°C to 80°C
Ambient Storage Temperature Range (4)	-10°C to 125°C
Weight (typical)	0.4 oz. (11 g)
Encapsulation	Thermally Conductive Epoxy
Enclosure and PCB	Meet the requirements of IEC60335-1

WIRING DIAGRAM

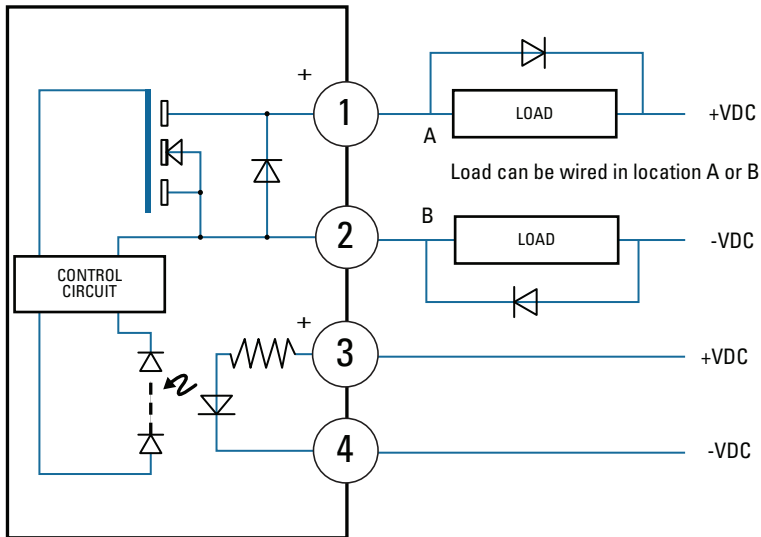

THERMAL DERATE INFORMATION

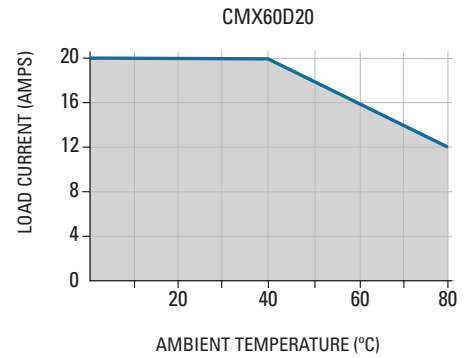
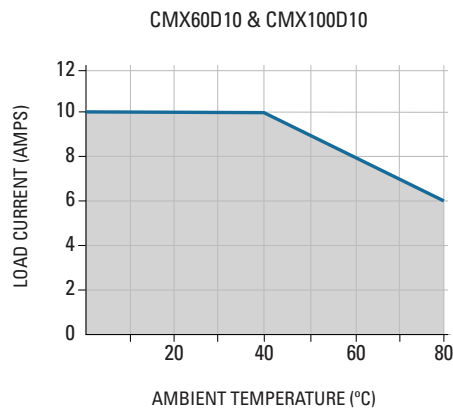
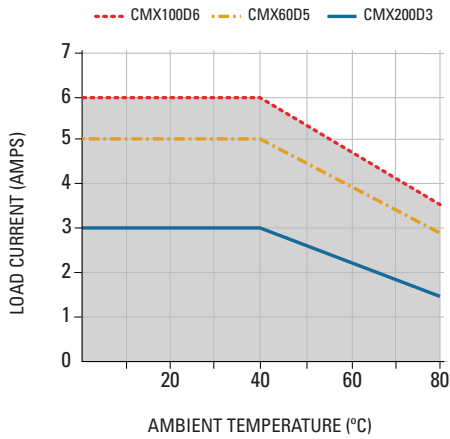

MECHANICAL SPECIFICATIONS

Tolerances: ± 0.02 in / 0.5 mm
All dimensions are in: inches (millimeters)

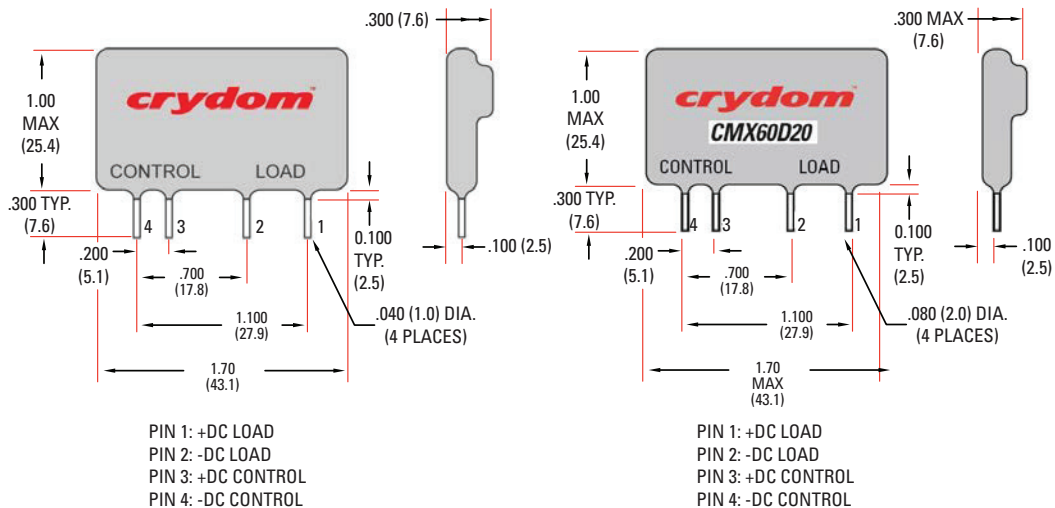

AGENCY APPROVALS & CERTIFICATIONS

Designed in accordance with the requirements of IEC 62314
EN60950 : Meets the requirements of sections 1.5: 1.7: 2.9: 2.10.5.3: 4.2: 4.5: 4.7:
IEC60335-1: Resistance to heat and fire meets the requirements of section 30, evaluated by TUV SUD.
Glow Wire Test, per requirements of IEC/EN 60695-2-10 and IEC/EN 60695-2-11
Ball Pressure Test, per requirements of IEC/EN 60695-10-2

 E116950 (3 Amps, 6 Amps and 10 Amps Models)



GENERAL NOTES

- 1) All parameters at 25°C unless otherwise specified.
- 2) @ rated current (RDS-ON).
- 3) Dielectric and insulation resistance are measured between input and output.
- 4) Low temperature range is limited to -10°C in 20 Amps models.
- 5) Inductive loads should be diode suppressed.
- 6) At 55 VDC.

WARNINGS



RISK OF MATERIAL DAMAGE AND HOT ENCLOSURE

- The product's side panels may be hot, allow the product to cool before touching
 - Follow proper mounting instructions including torque values
 - Do not allow liquids or foreign objects to enter this product
- Failure to follow these instructions can result in serious injury, or equipment damage.**



HAZARD OF ELECTRIC SHOCK, EXPLOSION OR ARCH FLASH

- Disconnect all power before installing or working with this equipment
 - Verify all connections and replace all covers before turning on power
- Failure to follow these instructions will result in death or serious injury**

Sensata Technologies, Inc. ("Sensata") data sheets are solely intended to assist designers ("Buyers") who are developing systems that incorporate Sensata products (also referred to herein as "components"). Buyer understands and agrees that Buyer remains responsible for using its independent analysis, evaluation and judgment in designing Buyer's systems and products. Sensata data sheets have been created using standard laboratory conditions and engineering practices. Sensata has not conducted any testing other than that specifically described in the published documentation for a particular data sheet. Sensata may make corrections, enhancements, improvements and other changes to its data sheets or components without notice.

Buyers are authorized to use Sensata data sheets with the Sensata component(s) identified in each particular data sheet. HOWEVER, NO OTHER LICENSE, EXPRESS OR IMPLIED, BY ESTOPPEL OR OTHERWISE TO ANY OTHER SENSATA INTELLECTUAL PROPERTY RIGHT, AND NO LICENSE TO ANY THIRD PARTY TECHNOLOGY OR INTELLECTUAL PROPERTY RIGHT, IS GRANTED HEREIN. SENSATA DATA SHEETS ARE PROVIDED "AS IS". SENSATA MAKES NO WARRANTIES OR REPRESENTATIONS WITH REGARD TO THE DATA SHEETS OR USE OF THE DATA SHEETS, EXPRESS, IMPLIED OR STATUTORY, INCLUDING ACCURACY OR COMPLETENESS. SENSATA DISCLAIMS ANY WARRANTY OF TITLE AND ANY IMPLIED WARRANTIES OF MERCHANTABILITY, FITNESS FOR A PARTICULAR PURPOSE, QUIET ENJOYMENT, QUIET POSSESSION, AND NON-INFRINGEMENT OF ANY THIRD PARTY INTELLECTUAL PROPERTY RIGHTS WITH REGARD TO SENSATA DATA SHEETS OR USE THEREOF.

All products are sold subject to Sensata's terms and conditions of sale supplied at www.sensata.com SENSATA ASSUMES NO LIABILITY FOR APPLICATIONS ASSISTANCE OR THE DESIGN OF BUYERS' PRODUCTS. BUYER ACKNOWLEDGES AND AGREES THAT IT IS SOLELY RESPONSIBLE FOR COMPLIANCE WITH ALL LEGAL, REGULATORY AND SAFETY-RELATED REQUIREMENTS CONCERNING ITS PRODUCTS, AND ANY USE OF SENSATA COMPONENTS IN ITS APPLICATIONS, NOTWITHSTANDING ANY APPLICATIONS-RELATED INFORMATION OR SUPPORT THAT MAY BE PROVIDED BY SENSATA.

Mailing Address: Sensata Technologies, Inc., 529 Pleasant Street, Attleboro, MA 02703, USA.

CONTACT US

Americas

+1 (877) 502 5500 – Option 2
sales.crydom@sensata.com

Europe, Middle East & Africa

+44 (1202) 416170
ssr-info.eu@sensata.com

Asia Pacific

sales.isasia@list.sensata.com
China +86 (21) 2306 1500
Japan +81 (45) 277 7117
Korea +82 (31) 601 2004
India +91 (80) 67920890
Rest of Asia +886 (2) 27602006
ext 2808