

1

2

3

4

5

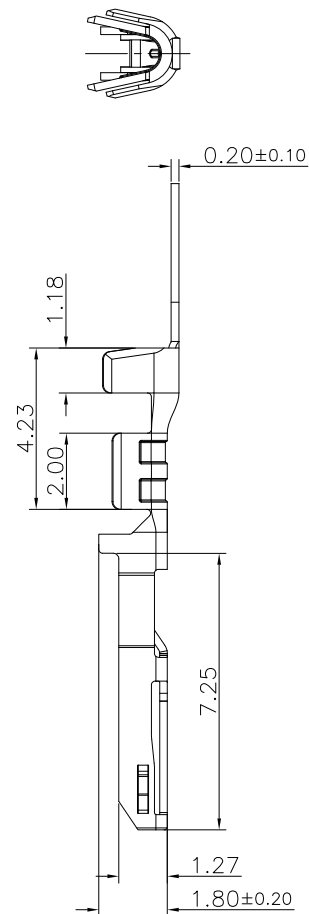
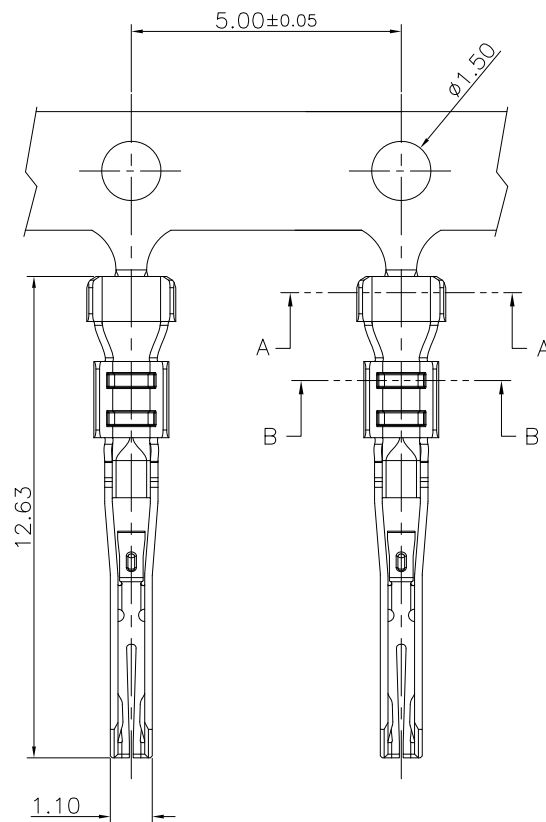

Specifications:

Current Rating:6.5A AC,DC
 Voltage Rating:250V AC,DC
 Contact Resistance:10m ohm.Max
 Insulation Resistance:1000M ohm.Min
 Withstanding Voltage:1500V AC/Minute
 Operating Temperature Range:-40°C~+105°C

Material and Finish

Terminal:Brass
 Plating:Tin Plated
 Applicable Wire:24AWG~26AWG
 24AWG Wire,OD 1.3mm Max.

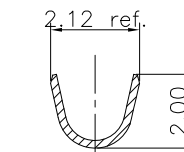
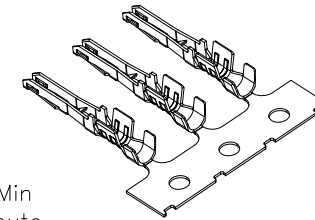

Section:A-A'

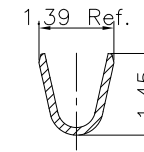

Section:B-B'

RoHS Compliant

DRAWN:

GENERAL TOLERANCE:

.X=±0.20
 .XX=±0.15

CHECKED:

UNIT: MM

DESCRIPTION: Wire To Board Housing Terminal,
 2.5mm, 24-26AWG, Front Lock

SIZE

APPROVAL:

SCALE:1:1

SHEET: 1 / 2

PART NO:

54025-2426

A4

REV

DATE

FILE

BY

PROJECTION:

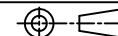

CnC Tech

Industrial Cable and Connector Technology

A
B
C
D