

LOW-POWER OFF-LINE PRIMARY SIDE REGULATION CONTROLLER

NEW PRODUCT

Description

The AP3771 is a high performance AC/DC power supply controller for battery charger and adapter applications. The device uses Pulse Frequency Modulation (PFM) method to build discontinuous conduction mode (DCM) flyback power supplies.

The AP3771 provides accurate constant voltage, constant current (CV/CC) regulation without requiring an opto-coupler and the secondary control circuitry. It also eliminates the need of loop compensation circuitry while maintaining good stability. The AP3771 can achieve excellent regulation and high average efficiency, yet meets no-load consumption less than 30mW. It can also achieve excellent dynamic performance while maintaining 30mW standby power with AP4340.

The AP3771 has a built-in fixed cable voltage drop compensation function. The cable compensation voltage is set as 7% and 3% of the rated output voltage. It also has an adjustable built-in line compensation function to achieve tight CC.

The AP3771 drives MOSFET to achieve the high switching frequency and high efficiency.

The AP3771 is available in SOT26 package.

Features

- Primary Side Control for Tight Constant Current and Constant Voltage
- 30mW No-load Input Power
- Excellent Dynamic Performance with AP4340 (For 5V Application)
- MOSFET Driving
- Proprietary Adjustable Line Compensation for CC Variation
- Constant and Built-in 7% and 3% Voltage Drop Compensation
- Enhanced Audio Noise Suppression
- Open Circuit Protection
- Over Voltage Protection
- Short Circuit Protection
- SOT26 Package
- **Totally Lead-free & Fully RoHS Compliant (Notes 1 & 2)**
- **Halogen and Antimony Free. "Green" Device (Note 3)**

Notes: 1. No purposely added lead. Fully EU Directive 2002/95/EC (RoHS) & 2011/65/EU (RoHS 2) compliant.
 2. See http://www.diodes.com/quality/lead_free.html for more information about Diodes Incorporated's definitions of Halogen- and Antimony-free, "Green" and Lead-free.
 3. Halogen- and Antimony-free "Green" products are defined as those which contain <900ppm bromine, <900ppm chlorine (<1500ppm total Br + Cl) and <1000ppm antimony compounds.

Pin Assignments

(Top View)

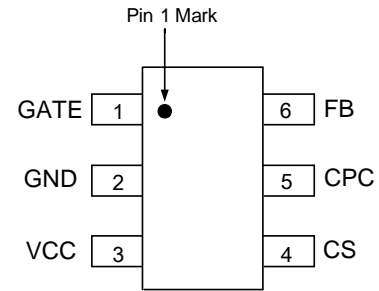

SOT26

Applications

- Adapters/Chargers for Cell/Cordless Phones, PDAs, MP3 and Other Portable Devices
- LED Driver
- Standby and Auxiliary Power Supplies

Typical Applications Circuit

NEW PRODUCT

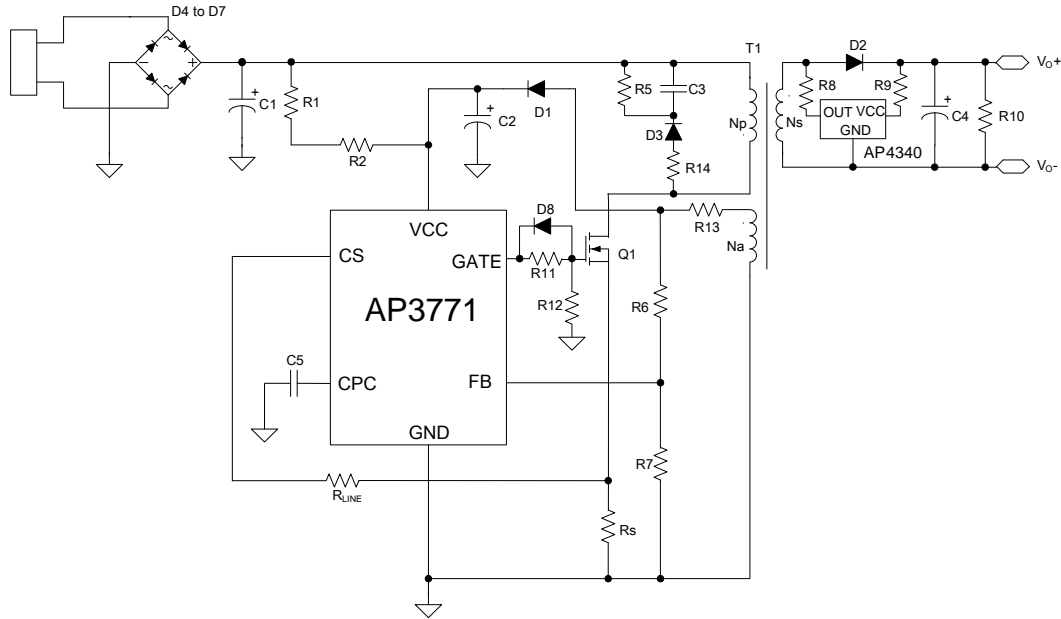

5V/1.8A Output for Battery Charger of Tablet PC
(The AP4340 Is Used to Achieve Fast Dynamic Response)

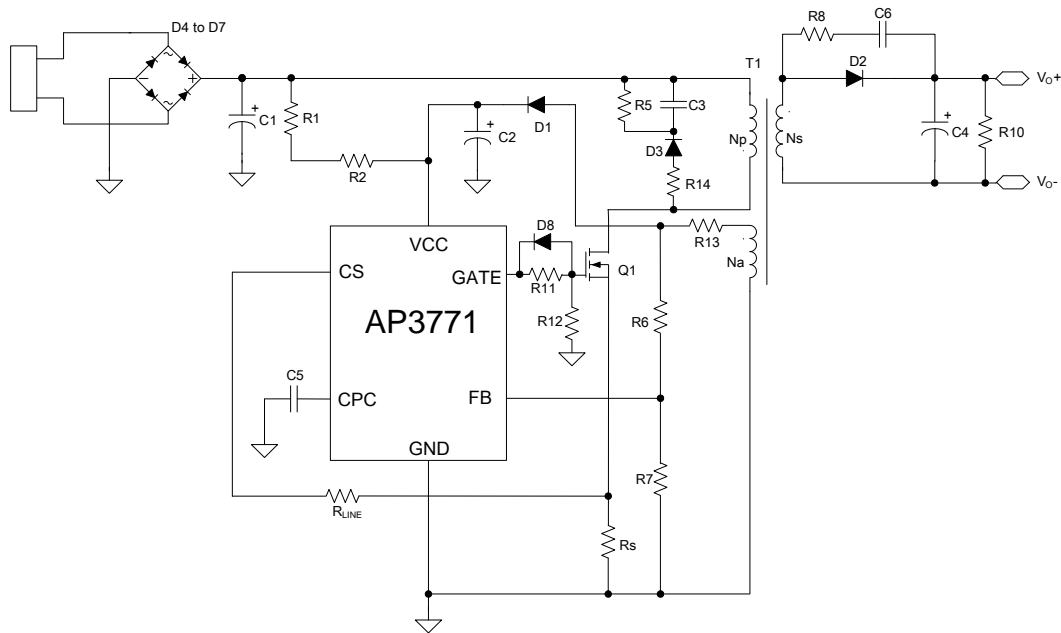

12V/1.5A Output for Adapter

Pin Descriptions

Pin Number	Pin Name	Function
1	GATE	The GATE pin is used to turn on and turn off the power switch. When turning on the power switch, the GATE pin will keep the gate voltage of the power MOSFET to 10V. When turning off the power switch, the resistance between the GATE and GND will become 40Ω
2	GND	The GND pin is the ground of the IC. When the power MOSFET is turned off, a fast reverse sinking current to the GATE of MOSFET will flow out from this pin. Attention should be paid to in the PCB layout
3	VCC	The VCC pin supplies the power for the IC. In order to get the correct operation of the IC, a capacitor with low ESR should be placed as close as possible to the VCC pin
4	CS	The CS is the current sense pin of the IC. The IC will turn off the power MOSFET according to the voltage on the CS pin. When the power MOSFET is on, a current is output from the CS pin which is proportional to the line voltage to realize the function of line compensation
5	CPC	A capacitor more than 50nF should be connected to this pin. The voltage of CPC pin is linear to load of the system and it is used for the functions of cable voltage drop compensation and audio noise suppression
6	FB	The CV and CC regulation are realized based on the voltage sampling of this pin

NEW PRODUCT

Functional Block Diagram

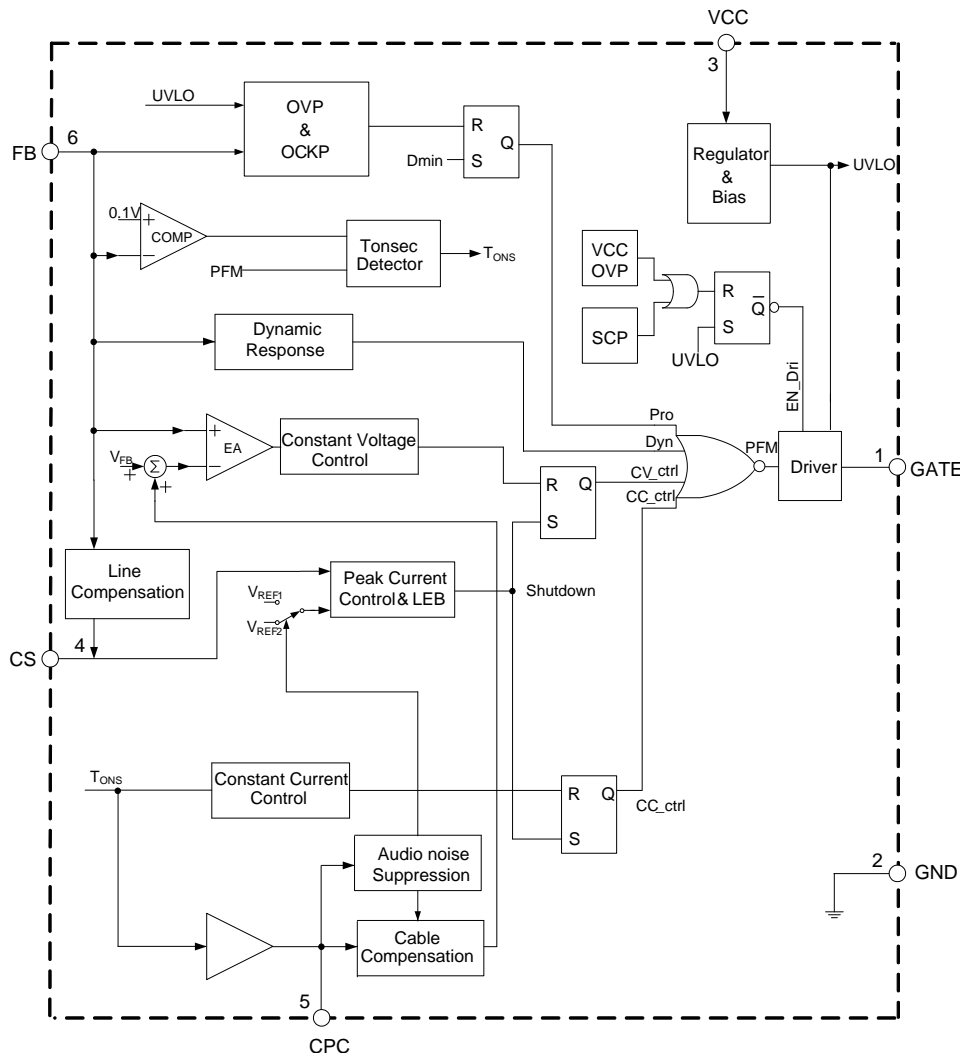

Absolute Maximum Ratings (Note 4)

Symbol	Parameter	Rating	Unit
V_{CC}	Supply Voltage	-0.3 to 30	V
–	CS, CPC to GND	-0.3 to 7	V
V_{FB}	FB Input Voltage	-40 to 10	V
–	Output Voltage at GATE	-0.3 to 15	V
T_J	Operating Junction Temperature	+150	°C
T_{STG}	Storage Temperature	-65 to +150	°C
T_{LEAD}	Lead Temperature (Soldering, 10 sec)	+300	°C
θ_{JA}	Thermal Resistance (Junction to Ambient)	200	°C/W

Note 4: Stresses greater than those listed under "Absolute Maximum Ratings" may cause permanent damage to the device. These are stress ratings only, and functional operation of the device at these or any other conditions beyond those indicated under "Recommended Operating Conditions" is not implied. Exposure to "Absolute Maximum Ratings" for extended periods may affect device reliability.

Electrical Characteristics ($V_{CC}=15V$, $T_A=+25^\circ C$, unless otherwise specified.)

Symbol	Parameter	Conditions	Min	Typ	Max	Unit
UVLO SECTION						
$V_{TH}(ST)$	Startup Voltage Threshold	–	13	15.5	18	V
$V_{OPR}(MIN)$	Minimal Operating Voltage	–	5.5	6.5	7.5	V
STANDBY CURRENT SECTION						
I_{ST}	Startup Current	$V_{CC}=V_{TH}(ST)-1V$, Before startup	0	0.2	0.6	μA
$I_{CC}(OPR)$	Operating Current	Static current	300	400	500	
DRIVE OUTPUT SECTION						
V_{GATE}	Gate Voltage	–	8	10	12	V
I_{SOURCE}	Source Current	$V_{GATE}=0V$	30	75	120	mA
$R_{DS(ON)}$	Sink Resistance	–	30	40	50	Ω
LINE COMPENSATION SECTION						
g_m	Line Compensation Transconductance (Note 5)	–	1.1	1.5	1.9	μS
CURRENT SENSE SECTION						
V_{CS}	Current Sense Threshold Voltage at Heavy Load (CV Mode) and CC Mode	–	480	510	540	mV
t_{LEB}	Leading Edge Blanking	–	300	475	800	ns
FEEDBACK INPUT SECTION						
V_{FB}	Feedback Threshold	–	3.94	4	4.06	V
I_{FB}	FB Input Leakage Current	$V_{FB}=4V$	2	3	4	μA
CABLE COMPENSATION SECTION						
$\Delta V_{FB-CABLE}/V_{FB}\%$	Cable Compensation Voltage	AP3771A	6	7	8	%
		AP3771B	2	3	4	%

Electrical Characteristics (Cont.) ($V_{CC}=15V$, $T_A=+25^\circ C$, unless otherwise specified.)

Symbol	Parameter	Conditions	Min	Typ	Max	Unit
DYNAMIC FUNCTION SECTION						
t_D	Blanking Time for Dynamic Function	–	110	140	170	μs
$V_{TRIGGER}$	Trigger Voltage for Dynamic Function	–	115	150	185	mV
PROTECTION SECTION						
$V_{CC}(OVP)$	OVP of V_{CC}	–	25	27.5	30	V
$V_{FB}(OVP)$	OVP of V_{FB}	–	5.5	6.5	7.5	V
$V_{FB}(SCP)$	Short Circuit Protection	–	1.0	1.2	1.4	V
$t_{ONP}(MAX)$	Maximum t_{ONP}	–	24	35	46	μs
$t_{OFF}(MAX)$	Maximum Off Time	–	14	18	25	ms

Note 5: Line compensation voltage on CS pin: $\Delta V_{CS} = V_{IN_DC} \cdot \frac{N_{AUX}}{N_{PRI}} \cdot \frac{R_7}{R_6 + R_7} \cdot g_m \cdot R_{LINE}$

Performance Characteristics

$I_{CC}(OPR)$ vs. V_{CC}

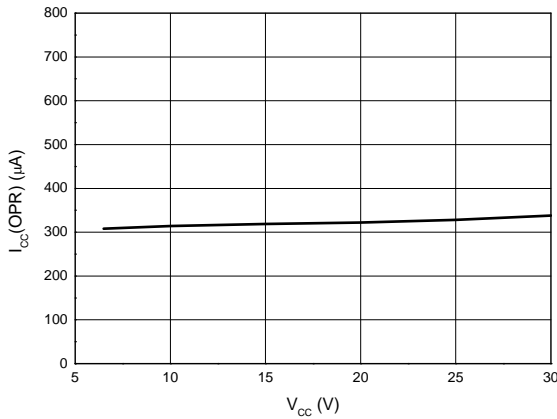

I_{FB} vs. V_{CC}

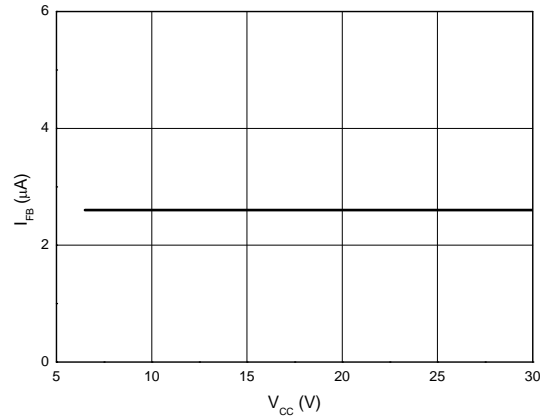

V_{GATE} vs. V_{CC}

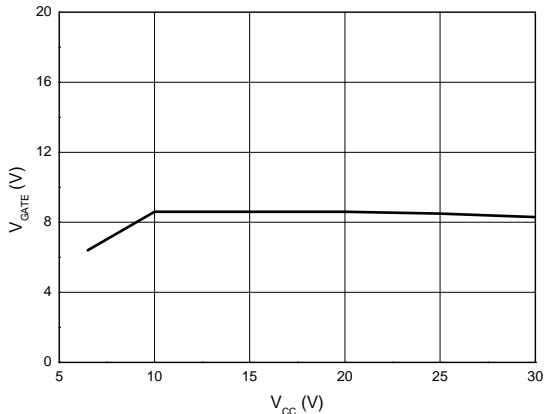

$t_{ONP}(MAX)$ vs. V_{CC}

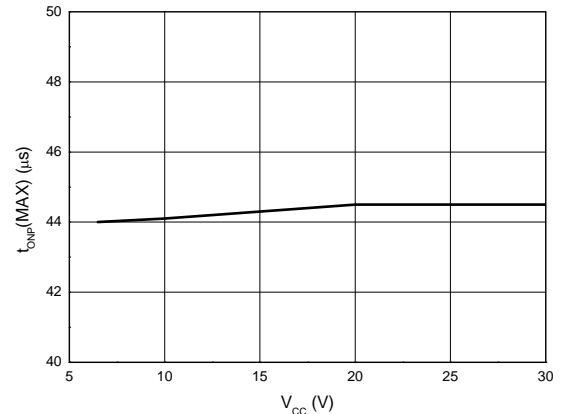

Performance Characteristics (Cont.)

$t_{OFF}(MAX)$ vs. V_{CC}

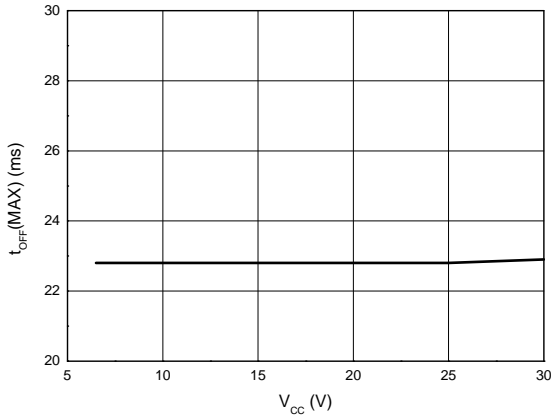

t_{LEB} vs. V_{CC}

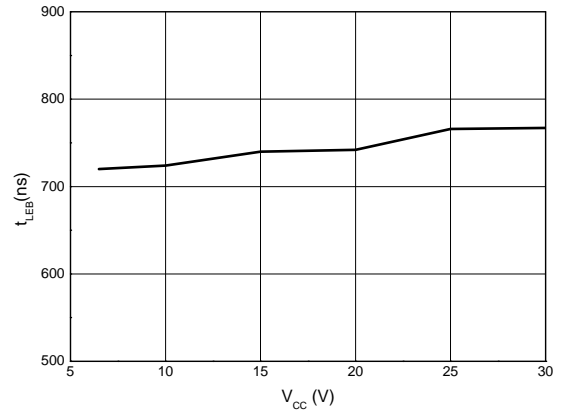

t_{LEB} vs. T_A

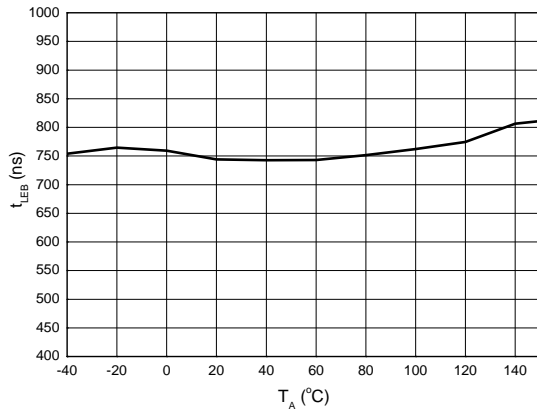

$t_{ONP}(MAX)$ vs. T_A

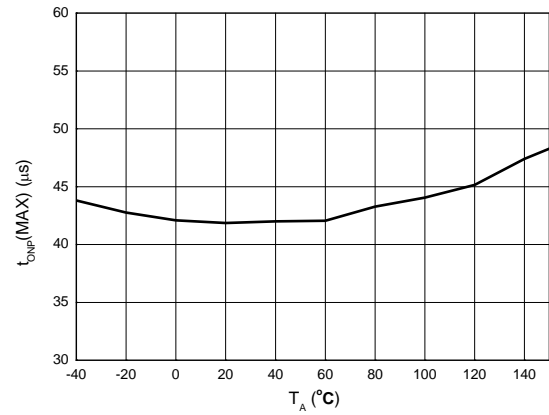

$V_{TH}(ST)$ vs. T_A

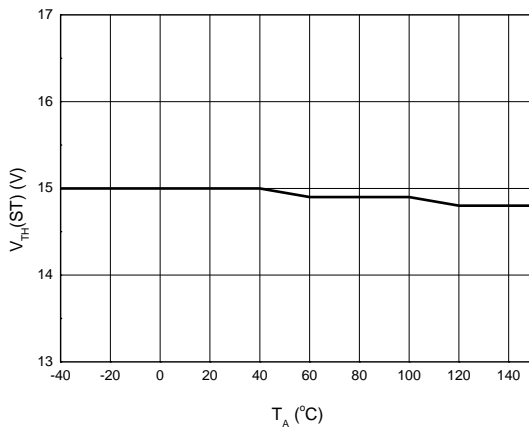

$V_{OPR}(MIN)$ vs. T_A

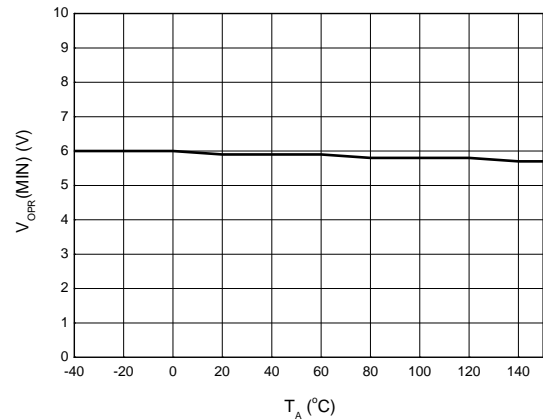

NEW PRODUCT

Performance Characteristics (Cont.)

I_{CC(OPR)} vs. T_A

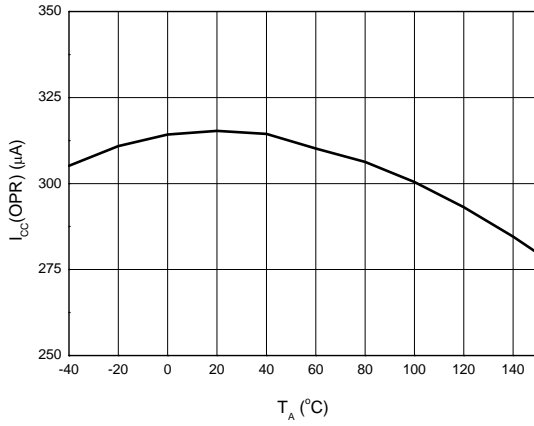

I_{ST} vs. T_A

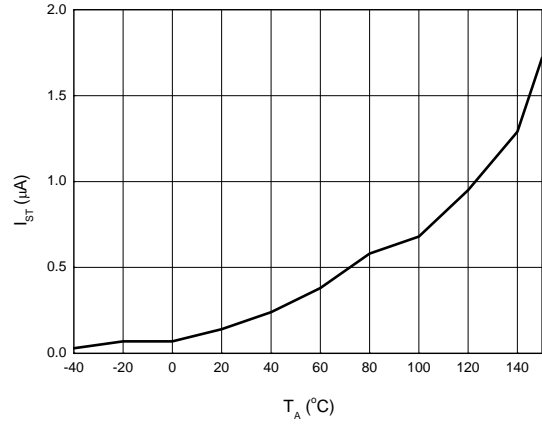

t_{OFF(MAX)} vs. T_A

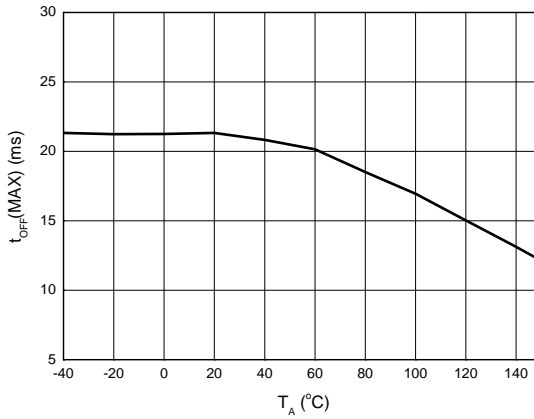

V_{GATE} vs. T_A

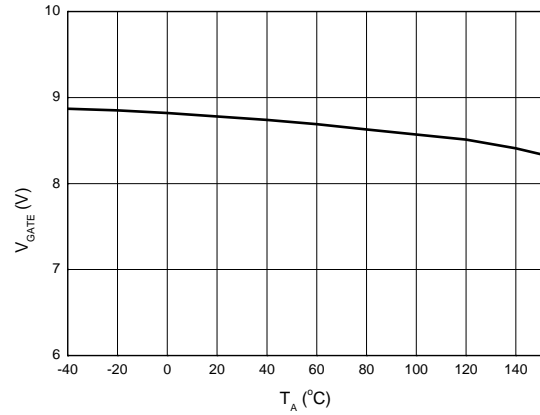

R_{DS(ON)} vs. T_A

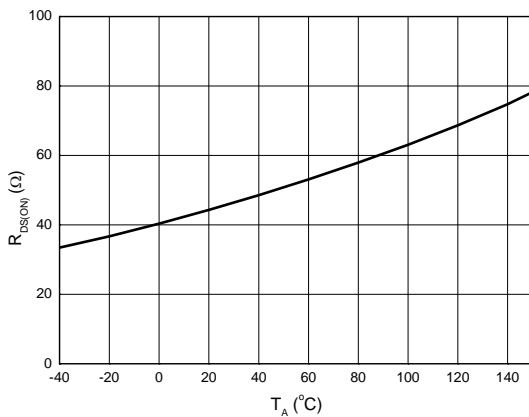

V_{FB} vs. T_A

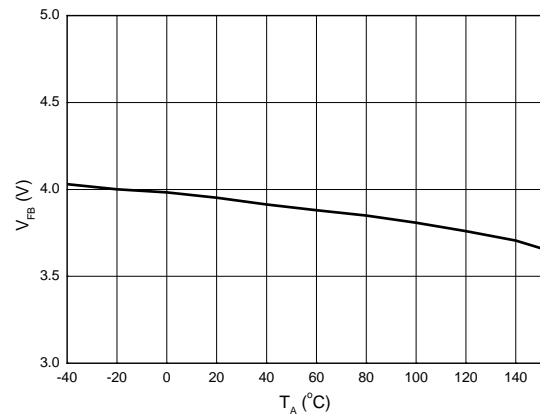

Ordering Information

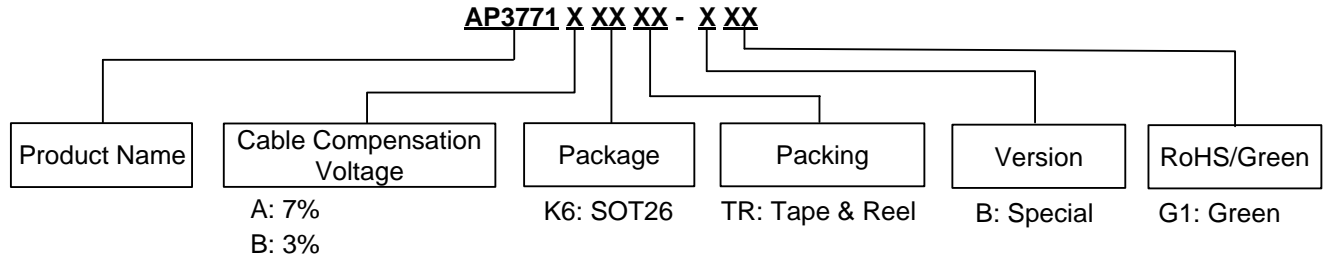

Diodes IC's Pb-free products with "G1" suffix in the part number, are RoHS compliant and green.

Package	Temperature Range	Cable Compensation Voltage	Part Number	Marking ID	Packing
SOT26	-40 to +85°C	7%	AP3771AK6TR-BG1	GJI	3000/Tape & Reel
		3%	AP3771BK6TR-BG1	GJJ	3000/Tape & Reel

Marking Information

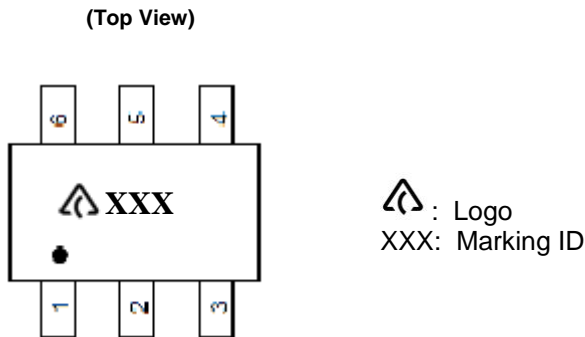

Package Outline Dimensions (All dimensions in mm(inch).)

(1) Package Type: SOT26

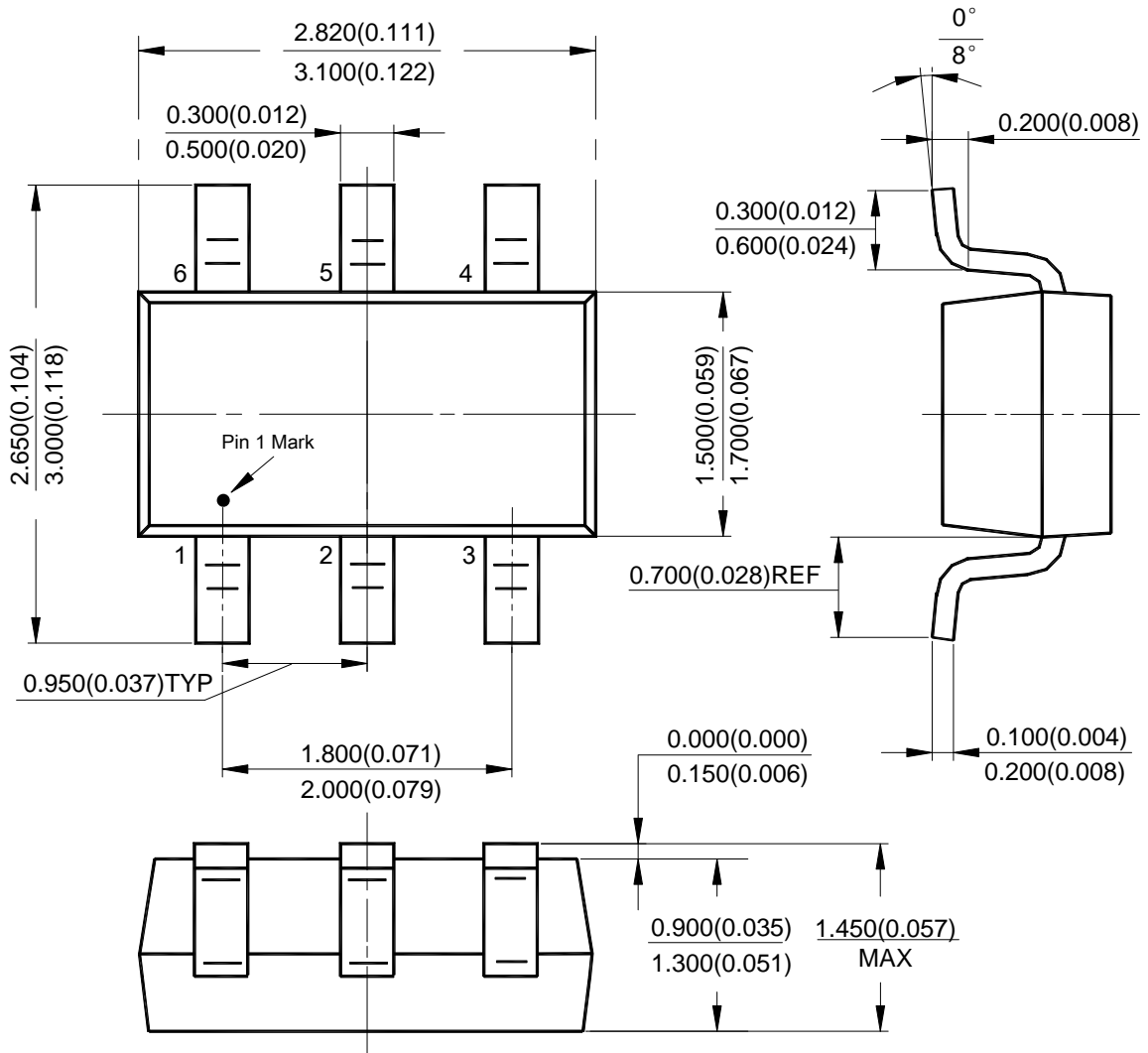

NEW PRODUCT

Suggested Pad Layout

(1) Package Type: SOT26

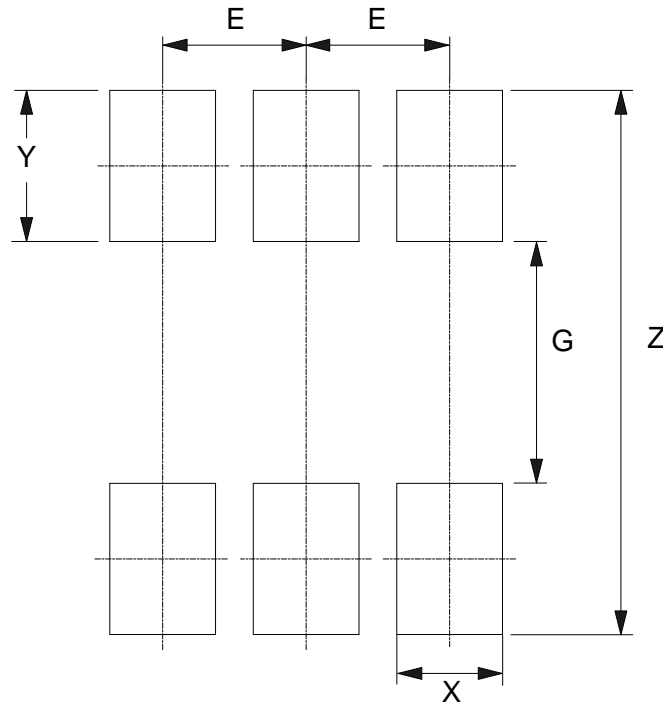

Dimensions	Z (mm)/(inch)	G (mm)/(inch)	X (mm)/(inch)	Y (mm)/(inch)	E (mm)/(inch)
Value	3.600/0.142	1.600/0.063	0.700/0.028	1.000/0.039	0.950/0.037

IMPORTANT NOTICE

DIODES INCORPORATED MAKES NO WARRANTY OF ANY KIND, EXPRESS OR IMPLIED, WITH REGARDS TO THIS DOCUMENT, INCLUDING, BUT NOT LIMITED TO, THE IMPLIED WARRANTIES OF MERCHANTABILITY AND FITNESS FOR A PARTICULAR PURPOSE (AND THEIR EQUIVALENTS UNDER THE LAWS OF ANY JURISDICTION).

Diodes Incorporated and its subsidiaries reserve the right to make modifications, enhancements, improvements, corrections or other changes without further notice to this document and any product described herein. Diodes Incorporated does not assume any liability arising out of the application or use of this document or any product described herein; neither does Diodes Incorporated convey any license under its patent or trademark rights, nor the rights of others. Any Customer or user of this document or products described herein in such applications shall assume all risks of such use and will agree to hold Diodes Incorporated and all the companies whose products are represented on Diodes Incorporated website, harmless against all damages.

Diodes Incorporated does not warrant or accept any liability whatsoever in respect of any products purchased through unauthorized sales channel. Should Customers purchase or use Diodes Incorporated products for any unintended or unauthorized application, Customers shall indemnify and hold Diodes Incorporated and its representatives harmless against all claims, damages, expenses, and attorney fees arising out of, directly or indirectly, any claim of personal injury or death associated with such unintended or unauthorized application.

Products described herein may be covered by one or more United States, international or foreign patents pending. Product names and markings noted herein may also be covered by one or more United States, international or foreign trademarks.

This document is written in English but may be translated into multiple languages for reference. Only the English version of this document is the final and determinative format released by Diodes Incorporated.

LIFE SUPPORT

Diodes Incorporated products are specifically not authorized for use as critical components in life support devices or systems without the express written approval of the Chief Executive Officer of Diodes Incorporated. As used herein:

A. Life support devices or systems are devices or systems which:

1. are intended to implant into the body, or
2. support or sustain life and whose failure to perform when properly used in accordance with instructions for use provided in the labeling can be reasonably expected to result in significant injury to the user.

B. A critical component is any component in a life support device or system whose failure to perform can be reasonably expected to cause the failure of the life support device or to affect its safety or effectiveness.

Customers represent that they have all necessary expertise in the safety and regulatory ramifications of their life support devices or systems, and acknowledge and agree that they are solely responsible for all legal, regulatory and safety-related requirements concerning their products and any use of Diodes Incorporated products in such safety-critical, life support devices or systems, notwithstanding any devices- or systems-related information or support that may be provided by Diodes Incorporated. Further, Customers must fully indemnify Diodes Incorporated and its representatives against any damages arising out of the use of Diodes Incorporated products in such safety-critical, life support devices or systems.

Copyright © 2014, Diodes Incorporated

www.diodes.com