

FAN6292CMX

Secondary Side Synchronous Rectifier Controller for Flyback Converters

Descriptions

The FAN6292CMX is a secondary-side synchronous rectifier (SR) controller for an isolated flyback converter operating in Discontinuous Conduction Mode (DCM). The adaptive dead time control algorithm minimizes the body diode conduction of SR MOSFET while guaranteeing stable and robust SR operation against noise and disturbance caused by the circuit parasitic.

When pair with FAN1080, PSR controller, FAN6292CMX can execute functions that are more valuable. Dynamic Response Enhancement (DRE) awakes primary controller quickly during load transient thus improves voltage dip.

FAN6292C are also source only USB Type-C controllers which are optimized for mobile chargers and power adapters. It supports standard 3 A VBUS current level is compatible as a load switch, and helps to reduce BOM cost.

Features

- Support Discontinuous Conduction Modes (DCM) and Boundary Conduction Mode (BCM)
- Adaptive Turn-Off Dead Time Tuning for General SR MOSFET Application
- Turn-On Trigger Blanking Time (Minimum Gate OFF Time) for Improved Noise Immunity
- Dynamic Response Enhancement (DRE) Function to Improve System Dynamic Response
- Type-C Control for Standard 3 A VBUS Current Level
- N-Channel MOSFET Control as a Load Switch for USB Type-C
- Minimum Turn-On Delay (20 ns)
- Supporting General Output Voltage (VIN) Range : 3.25 V ~ 20 V for LDO Input
- Fewest External Component Allowed

Applications

- Travel Adapter for Smart Phones, Feature Phones and Tablet PCs
- AC-DC Adapters for Portable Devices that Require CV/CC Control
- IoT Power Applications



ON Semiconductor®

www.onsemi.com



SOIC8
CASE 751EB

MARKING DIAGRAM

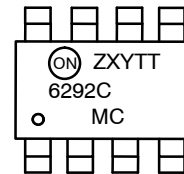

Z = Assembly Plant Code
X = Year Code
Y = Week Code
TT = Die Run Code
6292C = FAN6292C
M = SOP
C = Manufacture Code

PIN CONNECTIONS

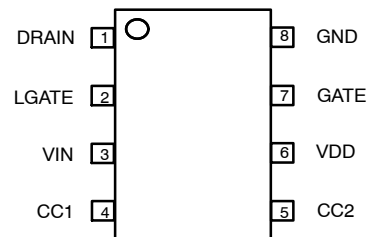

ORDERING INFORMATION

See detailed ordering and shipping information on page 2 of this data sheet.

FAN6292CMX

PACKAGE MARKING AND ORDERING INFORMATION

Part Number	Operating Temperature	Package	Packing Method
FAN6292CMX	-40 to 85°C	8-Lead, SOIC (Pb-Free)	2500/Tape & Reel

†For information on tape and reel specifications, including part orientation and tape sizes, please refer to our Tape and Reel Packaging Specifications Brochure, BRD8011/D.

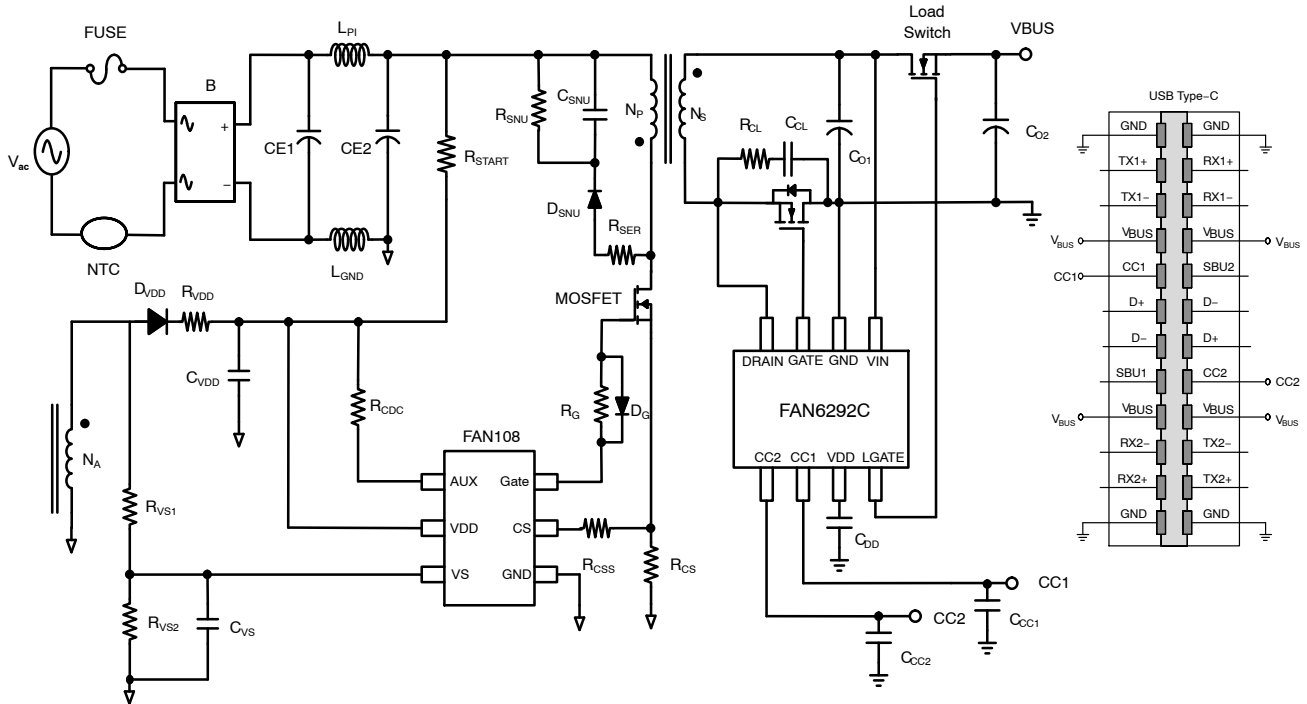

Figure 1. FAN6292C Typical Application Schematic

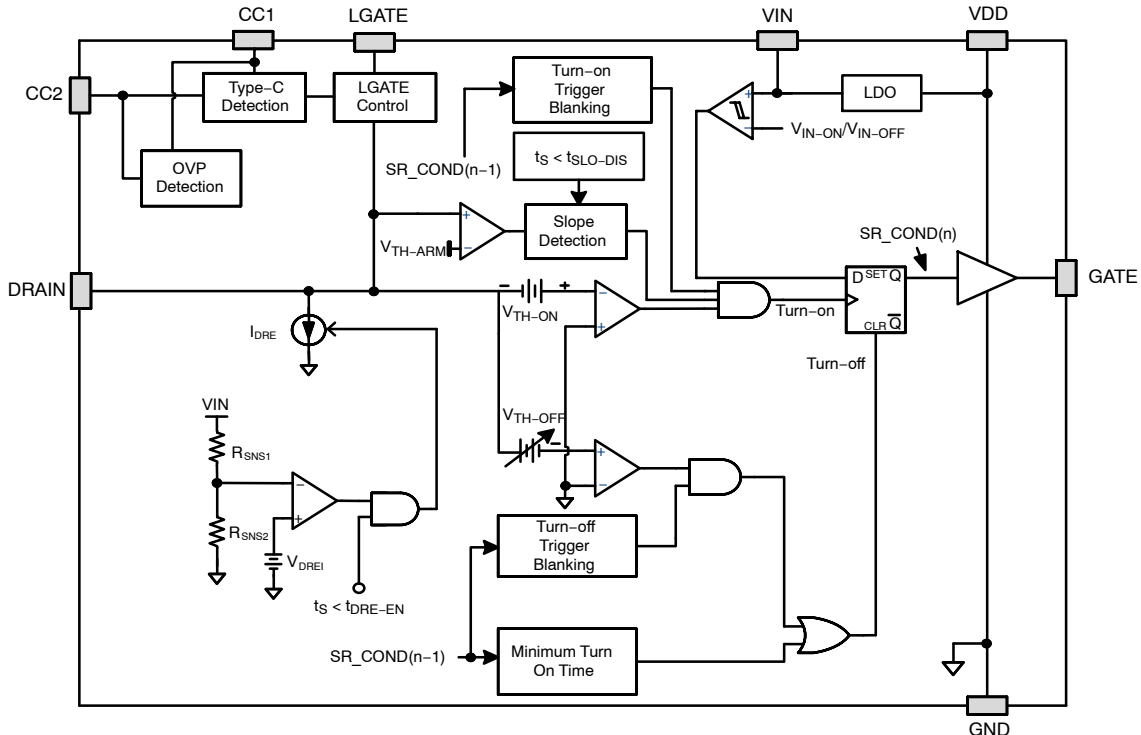

Figure 2. FAN6292C Function Block Diagram

FAN6292CMX

Table 1. PIN FUNCTION DESCRIPTION

Pin #	Name	Description
1	DRAIN	Synchronous rectifier drain sense input.
2	LGATE	Load switch controlling.
3	VIN	Input voltage pin. This pin is connected to the output of the adaptor to monitor its output voltage and supply internal bias. IC operating current, and MOSFET gate drive current are supplied through this pin.
4	CC1	Configuration Channel 1. This pin is used to detect connections of Type-C cables and connectors. It is tied to the USB-C CC1.
5	CC2	Configuration Channel 2. This pin is used to detect connections of Type-C cables and connectors. It is tied to the USB-C CC2.
6	VDD	Internal regulator 5 V output and gate drive power supply rail. Bypass with 1uF capacitor to GND.
7	GATE	Gate driver output.
8	GND	Ground.

Table 2. ABSOLUTE MAXIMUM RATINGS

Symbol	Parameter	Value	Unit
V _{IN}	Power Supply Pin Voltage	-0.3 to 20	V
V _{DRAIN}	Drain Sense Pin Voltage	-1 to 65	V
V _{LGATE}	LGATE PIN Voltage	-0.3 to 20	V
V _{DD}	Internal Regulator Pin Voltage	-0.3 to 6.5	V
V _{GATE}	Gate Pin Voltage	-0.3 to 6.5	V
V _{CC1}	CC1 Pin Input Voltage	-0.3 to 6.0	V
V _{CC2}	CC2 Pin Input Voltage	-0.3 to 6.0	V
P _D	Power Dissipation (T _A = 25°C)	0.651	W
T _J	Operation Junction Temperature	-40 to 125	°C
T _{STG}	Storage Temperature Range	-60 to 150	°C
T _L	Lead Temperature (Soldering) 10 Seconds	260	°C
ESD	Electrostatic Discharge Capability – Charged Device Model (CDM)	0.5	kV
	Electrostatic Discharge Capability – Human Body Model (HBM)	2	

Stresses exceeding those listed in the Maximum Ratings table may damage the device. If any of these limits are exceeded, device functionality should not be assumed, damage may occur and reliability may be affected.

1. All voltage values, except differential voltages, are given with respect to the GND pin.
2. Stresses beyond those listed under Absolute Maximum Ratings may cause permanent damage to the device.
3. Meets JEDEC standards JS-001-2012 and JESD 22-C101.

Table 3. THERMAL CHARACTERISTICS

Symbol	Parameter	Min	Unit
θ _{JA}	Junction-to-Ambient Thermal Impedance	150.9	°C/W
θ _{JT}	Junction-to-Top Thermal Impedance	13.4	°C/W

4. T_A = 25°C unless otherwise specified.

Table 4. RECOMMENDED OPERATING RANGES

Symbol	Parameter	Min	Max	Unit
V _{DRAIN}	Drain Pin Voltage	-1	60	V
V _{IN}	VIN Pin Voltage	3.5	20	V
V _{LGATE}	LGATE Pin Voltage	0	19.5	V
V _{GATE}	GATE Pin Voltage	0	5.5	V

FAN6292CMX

Table 4. RECOMMENDED OPERATING RANGES (continued)

Symbol	Parameter	Min	Max	Unit
V _{DD}	VDD Pin Voltage	3.1	5.5	V
V _{CC1/V_{CC2}}	CC1/CC2 Pin Voltage	0	5.8	V

Functional operation above the stresses listed in the Recommended Operating Ranges is not implied. Extended exposure to stresses beyond the Recommended Operating Ranges limits may affect device reliability.

Table 5. ELECTRICAL CHARACTERISTICS

V_{IN} = 5.5 V and T_A = -40°C to 125°C unless otherwise noted.

Symbol	Parameter	Test Conditions	Min	Typ	Max	Unit
--------	-----------	-----------------	-----	-----	-----	------

VDD SECTION

V _{IN-ON}	Turn-On Threshold	V _{IN} rising	3.06	3.15	3.25	V
V _{IN-OFF}	Turn-Off Threshold	V _{IN} falling	2.78	2.9	3.05	V
I _{IN-OP}	Operating Current	f _{SW} = 100 kHz, C _{GATE} = 3.3 nF, V _{IN} = 5 V		2.5	3.2	mA

POWER SUPPLY SECTION

V _{DD}	Internal LDO Output Voltage	V _{IN} = 20 V	5.0	5.25	5.5	V
V _{DO}	Dropout Voltage of LDO	I _{OUT} = 10 mA, V _{IN} = 3.3 V			0.3	V

DRAIN VOLTAGE SENSING SECTION

V _{OSI}	Comparator Input Offset Voltage (Note 5)	Internal Design Suggestion	-1	0	1	mV
V _{TH-ON}	Turn-On Threshold Voltage	R _{DRAIN} = 0 Ω (includes comparator input offset voltage)	-250	-200	-150	mV
t _{SLO-DIS}	Slope Detection Disable Criteria (Note 7)		53	58	63	μs
t _{SLO-HYS}	Slope Detection Disable Criteria Hysteresis (Note 5)			8		μs
t _{ON-DLY}	Turn On Delay (Note 5)	With 50 mV overdrive From V _{TH-ON} to Gate voltage over 1 V		20		ns
V _{TH-OFF}	Turn-Off Threshold Tuning Range		-5		5	mV
t _{OFF-DLY}	Comparator Delay for V _{TH-OFF} (Note 5)	With 0 mV overdrive From V _{TH-OFF} to Gate voltage equal 1 V		20		ns
V _{TH-ARM}	Gate Re-arming Threshold	V _{IN} = 5 V (typically 0.7 V _{DD})	3.3	3.5	3.7	V
t _{ARM}	Gate Re-arming Time for Slope Detection (Note 5)		70	85	100	ns
V _{TH-HGH}	Slope Detection High Threshold (Note 5)		0.4	0.5	0.6	V

MINIMUM ON-TIME AND MINIMUM OFF-TIME SECTION

t _{ON-MIN}	Minimum On-Time	t _S < (t _{SLO-DIS} - t _{SLO-HYS})	2.16	2.4	2.64	μs
t _{ON-MIN-L}	Minimum On-Time at Light Load	t _S ≥ t _{SLO-DIS}	1.50	1.65	1.80	μs
N _{ON-MIN-ST}	Minimum t _{ON} Cycles during Start-up			3		Cycles
t _{OFF-MIN-L}	Minimum Off-Time (Note 6)	t _S < (t _{SLO-DIS} - t _{SLO-HYS})	1.53	1.70	1.87	μs
t _{OFF-MIN-H}	Minimum On-Time at Light Load (Note 6)	t _S ≥ t _{SLO-DIS}	3.6	4	4.4	μs

DEAD TIME CONTROL SECTION

t _{DEAD}	Dead Time Self-Tuning Target (Note 5)	From GATE OFF to V _{DRAIN} rising above 0.5 V	170	200	230	ns
-------------------	---------------------------------------	--	-----	-----	-----	----

FAN6292CMX

Table 5. ELECTRICAL CHARACTERISTICS (continued)

$V_{IN} = 5.5\text{ V}$ and $T_A = -40^\circ\text{C}$ to 125°C unless otherwise noted.

Symbol	Parameter	Test Conditions	Min	Typ	Max	Unit
TYPE-C SECTION						
$V_{LGATE-ON}$	Drain Pin Threshold Voltage for LGATE Turn On		6.8	7.5	8.2	V
I_{P-CC1}	Source Current on CC1 Pin	$V_{IN} = 5\text{ V}, V_{CC1} = 0\text{ V}$	304	330	356	μA
I_{P-CC2}	Source Current on CC2 Pin	$V_{IN} = 5\text{ V}, V_{CC2} = 0\text{ V}$	304	330	356	μA
$Z_{OPEN-CC1}$	Input Impedance on CC1 Pin		126			$\text{k}\Omega$
$Z_{OPEN-CC2}$	Input Impedance on CC2 Pin		126			$\text{k}\Omega$
V_{RA-CC1}	Ra Impedance Detection Threshold on CC1 Pin	$V_{IN} = 5\text{ V}, V_{CC2} = 0\text{ V}$, decreasing V_{CC1}	0.75	0.80	0.85	V
V_{RA-CC2}	Ra Impedance Detection Threshold on CC2 Pin	$V_{IN} = 5\text{ V}, V_{CC1} = 0\text{ V}$, decreasing V_{CC2}	0.75	0.80	0.85	V
V_{RD-CC1}	Rd Impedance Detection Threshold on CC1 Pin	$V_{IN} = 5\text{ V}, V_{CC2} = 0\text{ V}$, increasing V_{CC1}	2.45	2.60	2.75	V
V_{RD-CC2}	Rd Impedance Detection Threshold on CC2 Pin	$V_{IN} = 5\text{ V}, V_{CC1} = 0\text{ V}$, increasing V_{CC2}	2.45	2.60	2.75	V
$t_{CC-Detach-Debounce}$	UFP Detachment Debounce Time	$V_{IN} = 5\text{ V}, V_{CC2} = 0\text{ V}$, decreasing V_{CC1}	10	15	20	ms
$t_{CC-Attach-Debounce}$	UFP Attachment Debounce Time	$V_{IN} = 5\text{ V}, V_{CC2} = 0\text{ V}$, increasing V_{CC1}	100	150	200	ms
V_{INGATE}	LGATE High Voltage for Load Switch Control	$V_{IN} = 5\text{ V}$	8		11	V

DRE SECTION

V_{DRE}	VIN Pin DRE Function Trigger Level (Note 6)	$V_{IN} = 5.5\text{ V} \rightarrow 4.5\text{ V}$	4.68	4.78	4.85	V
t_{DREI}	DRE Current Sinking Period (Note 5)	$V_{IN} = 5.5\text{ V} \rightarrow 4.5\text{ V}$	1.2	1.5	1.8	μs
t_{DRE-EN}	DRE Enable Period	$V_{IN} = 5.5\text{ V} \rightarrow 4.5\text{ V}$	64	72	80	μs
t_{RE-ARM}	DRE Re-arm Period	$V_{IN} = 5.5\text{ V} \rightarrow 4.5\text{ V}$		4		μs
I_{DRE}	DRE Sinking Current	Maximum I_{DRE} cycle are 14 every gate switching cycles	50			mA

OUTPUT DRIVER SECTION

V_{OL}	Gate Low Voltage	$V_{IN} = 6\text{ V}$			0.25	V
V_{OH}	Gate High Voltage	$V_{IN} = 6\text{ V}$	4.9			V
t_R	Gate Rise Time	$V_{IN} = 6\text{ V}, C_L = 3300\text{ pF}$, GATE = 1 V \rightarrow 4 V			90	ns
t_F	Gate Fall Time	$V_{IN} = 6\text{ V}, C_L = 3300\text{ pF}$, GATE = 4 V \rightarrow 1 V			30	ns

Product parametric performance is indicated in the Electrical Characteristics for the listed test conditions, unless otherwise noted. Product performance may not be indicated by the Electrical Characteristics if operated under different conditions.

5. Guaranteed by Design.

6. Specification operation temperature range -5°C to 85°C .

7. Specification operation temperature range -5°C to 50°C .

TYPICAL PERFORMANCE CHARACTERISTICS

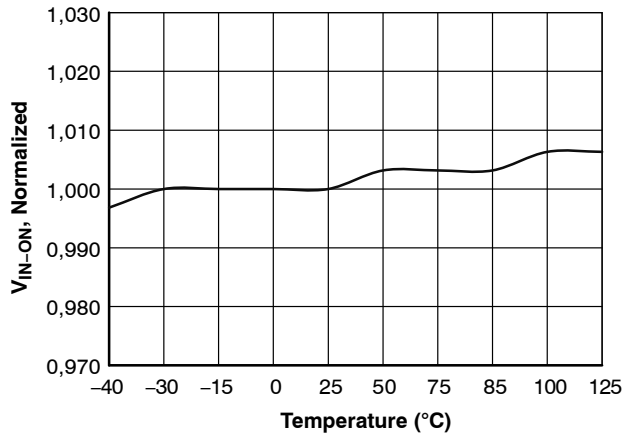

Figure 3. Turn-On Threshold Voltage (V_{IN-ON}) vs. Temperature

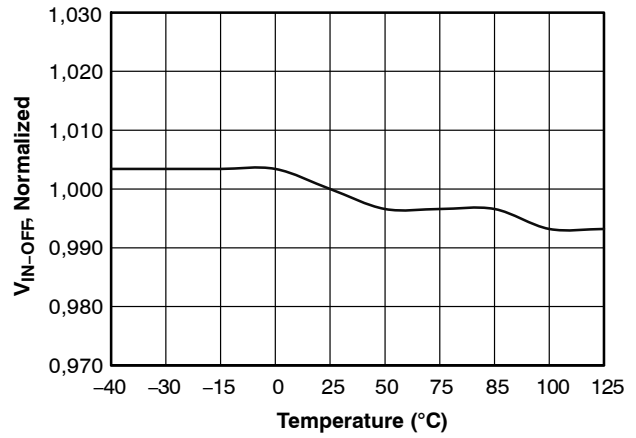

Figure 4. Turn-Off Threshold Voltage (V_{IN-OFF}) vs. Temperature

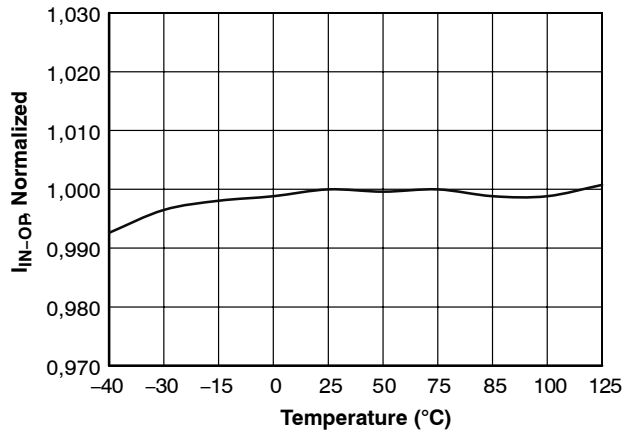

Figure 5. Operating Supply Current (I_{IN-OP}) vs. Temperature

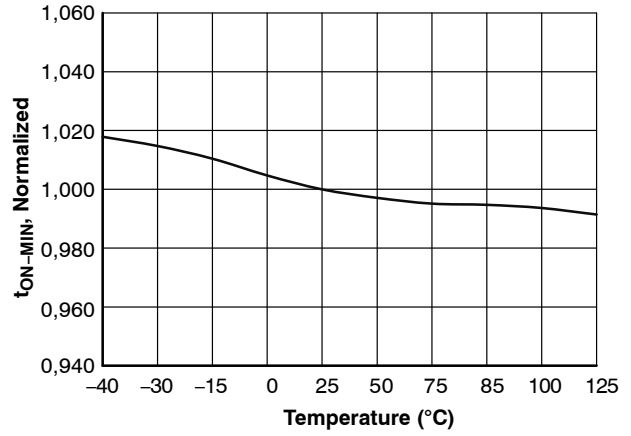

Figure 6. Minimum On Time (t_{ON-MIN}) vs. Temperature

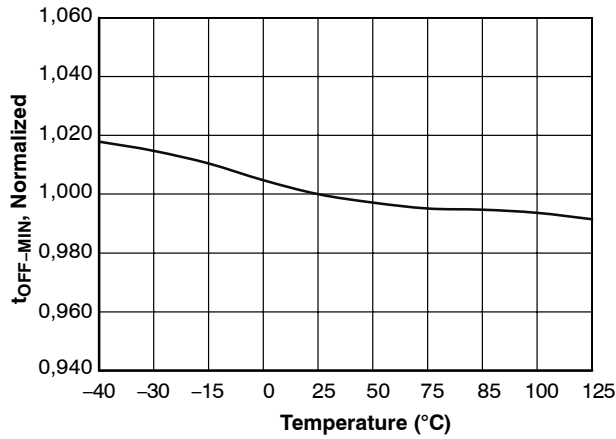

Figure 7. Minimum Gate Turn Off Time ($t_{OFF-MIN}$) vs. Temperature

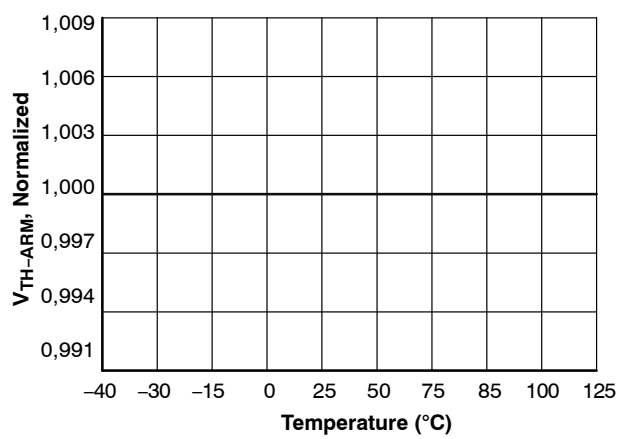

Figure 8. Gate Turn On Threshold Voltage (V_{TH-ARM}) vs. Temperature

TYPICAL PERFORMANCE CHARACTERISTICS (continued)

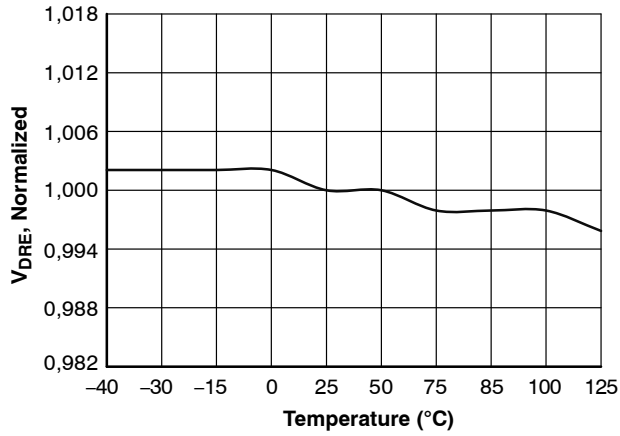

Figure 9. VIN Pin DRE Function Trigger Level (V_{DRE}) vs. Temperature

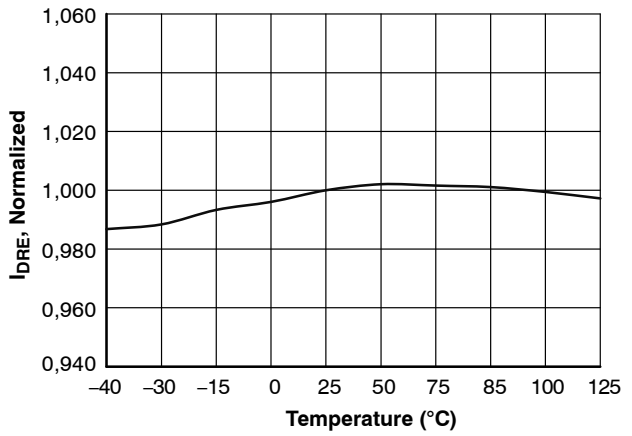

Figure 10. Drain Pin Sinking Current for DRE Triggered (I_{DRE}) vs. Temperature

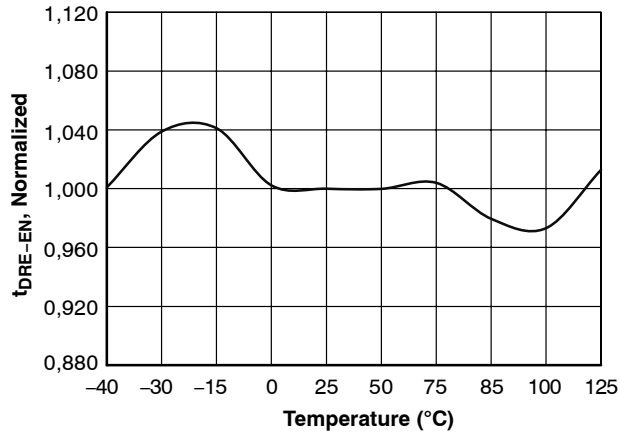

Figure 11. DRE Function Enable Period (t_{DRE-EN}) vs. Temperature

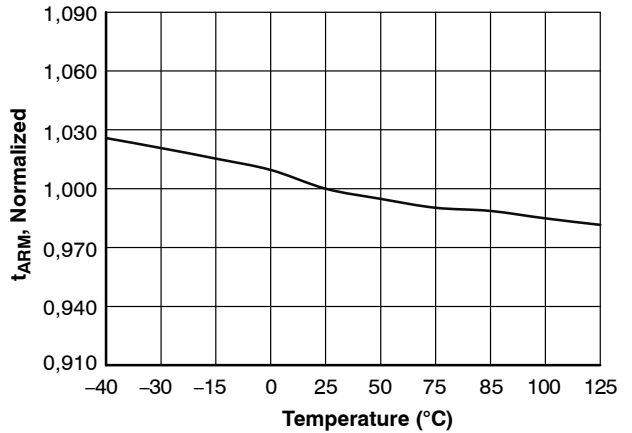

Figure 12. Gate Re-Arming Time for Slope Detection (t_{ARM}) vs. Temperature

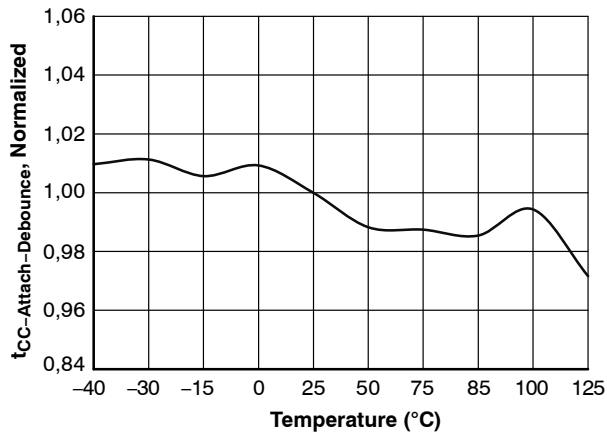

Figure 13. UFP Attachment Debounce Time ($t_{CC-Attach-Debounce}$) vs. Temperature

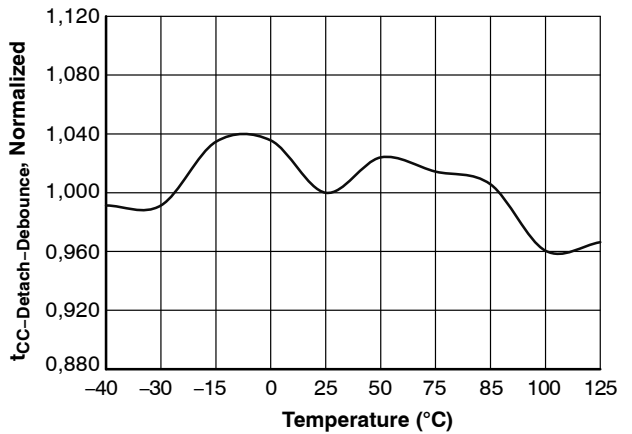

Figure 14. UFP Detachment Debounce Time ($t_{CC-Detach-Debounce}$) vs. Temperature

TYPICAL PERFORMANCE CHARACTERISTICS (continued)

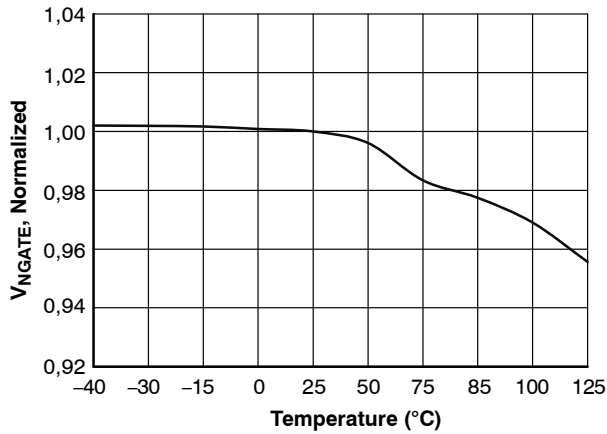

Figure 15. LGATE High Level Voltage (V_{NGATE}) vs. Temperature

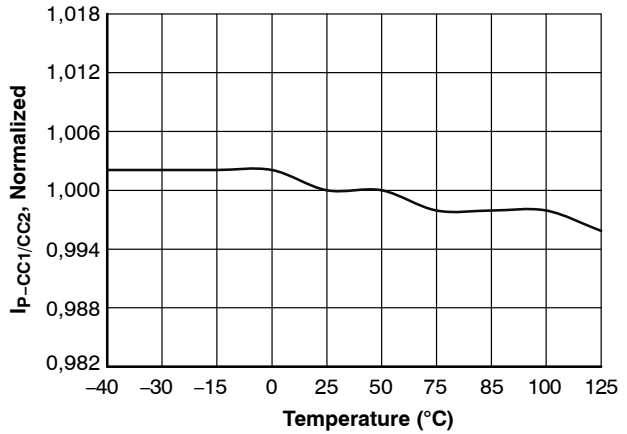

Figure 16. Source Current on CC1/CC2 Pin (I_{P-CC1/CC2}) vs. Temperature

FUNCTIONAL DESCRIPTION

Overview

For an ideal circuit operation, the SR control algorithm of FAN6292C is very straightforward. FAN6292C controls the SR MOSFET based on the instantaneous Drain-to-Source voltage as illustrated in Figure 17. When the body diode starts conducting, the drain-to-source voltage drops below the turn-on threshold (V_{TH-ON}) which triggers the turn-on of the gate. Then the product of R_{DS_ON} and instantaneous SR current determines the Drain-to-Source voltage. When the drain-to-source voltage reaches the turn-off threshold (V_{TH-OFF}) as SR MOSFET current decreases to near zero, FAN6292C turns off the gate. If the turn off threshold (V_{TH-OFF}) is very close to zero, the turn off dead time can be minimized.

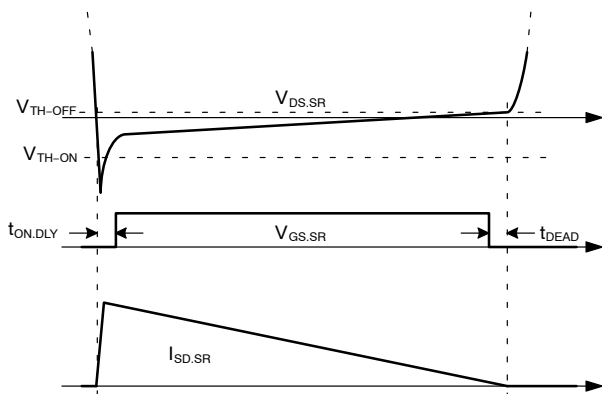

Figure 17. SR MOSFET Operation Waveforms (Ideal Case)

SR Turn-On Algorithm

As the diagram shown in Figure 18, the turn-on of SR GATE is triggered by the three input signals of AND gate. The first input signal is TURN_ON_ALLOW signal, which is given after t_{OFF-MIN} from the falling edge of V_{GS,SR} signal. The second input is the TURN_ON_TRG signal, which is enabled after DRAIN pin voltage drops below V_{TH-ON}. The third signal is t_{ARM} which allows turn-on trigger only when SR drain voltage drops fast with a large slope, preventing SR from triggering by the drain resonance voltage in DCM operation.

SR Turn-Off Algorithm

As diagram shown in Figure 19, the turn-off of SR GATE is triggered by turn off signal, which is enabled when V_{DS,SR} > V_{TH-OFF}.

FAN6292CMX

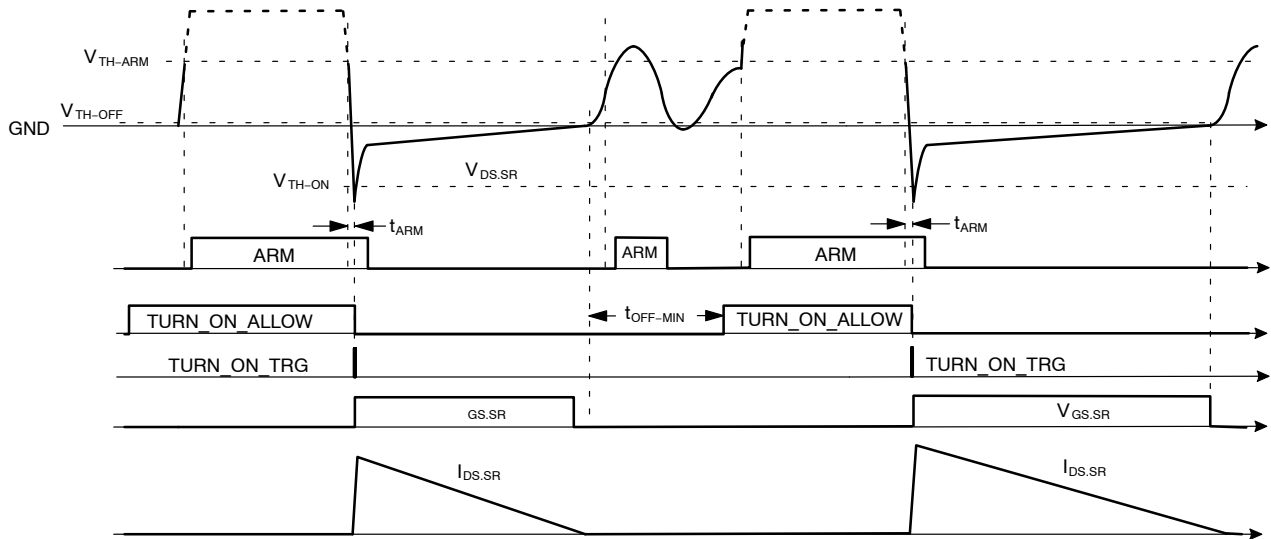

Figure 18. SR Turn-On Algorithm

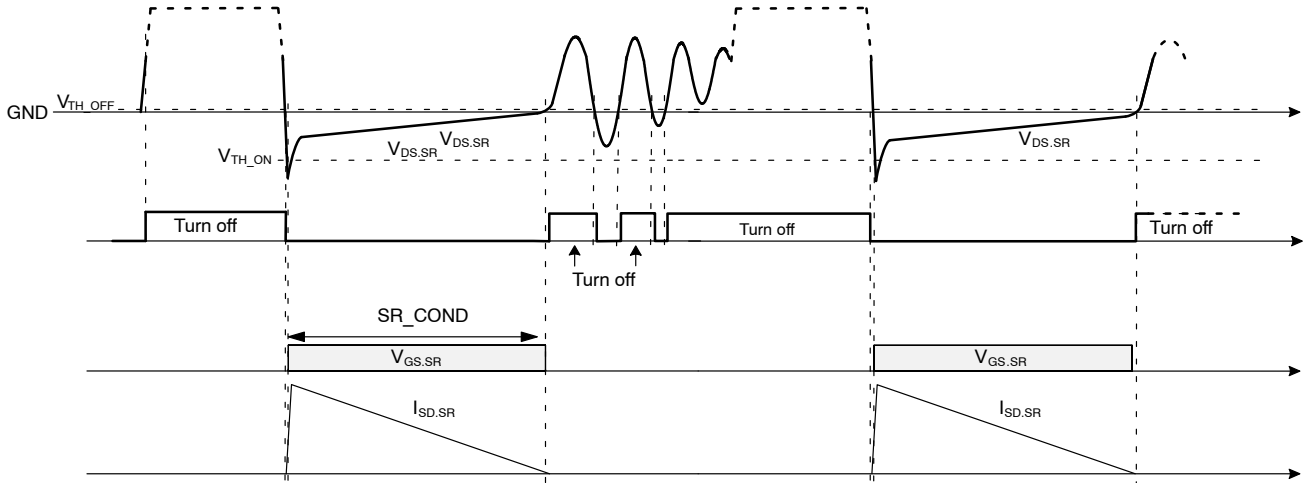

Figure 19. SR Turn-Off Algorithm

Slope Detection

FAN6292C checks SR drain voltage falling slope to distinguish primary FET off instant from the resonant curve. Continuously sees the time gap between SR drain voltage touches V_{TH-ARM} and V_{TH-ON} , this is compared with the internal fixed time of t_{ARM} , gate is only turn on when the time gap is less than t_{ARM} described at Figure 20.

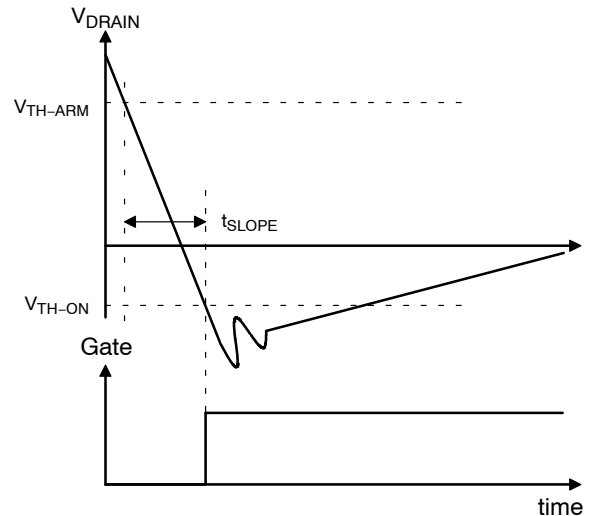

Figure 20. Slope Detection Timing Chart

Slope detection is good for identification SR on instance from the resonance, however, system configuration may give huge impact on the SR drain voltage so slope detection is not always good way for gate ON identification especially at light load. Due to this at light load, slope detection is enabled or disabled depend on period of Gate switching cycles (t_s) as below:

- $t_s < (t_{SLO-DIS} - t_{SLO-HYS})$: continually enable slope detection when t_s is decreasing
- $t_s \geq t_{SLO-DIS}$: basically slope detection is disabled and only enabled after gate rising edge until end of t_{DRE-EN} when t_s increasing

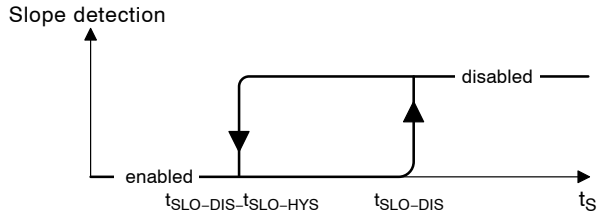

Figure 21. Slope Detect Enable/Disable Depend on t_s

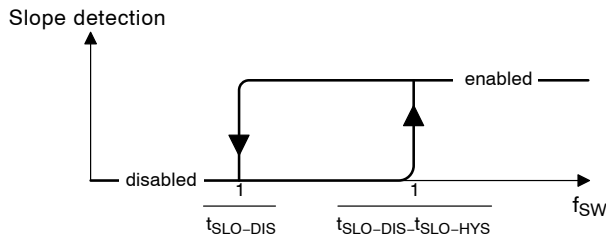

Figure 22. Slope Detect Enable/Disable Depend on f_{sw}

Gate Turn-On

FAN6292C turns on SR FET according to the voltage across SR drain and primary switching period of t_s . Depending on the t_s , gate turn on criteria is different and it is as below:

- $t_s < t_{SLO-DIS}$: SR FET ON when both (a) and (b) meet:
 - (a) V_{DRAIN} falling time from V_{TH-ARM} to V_{TH-ON} is less than t_{ARM}
 - (b) $V_{DRAIN} \leq V_{TH-ON}$
- $t_s < (t_{SLO-DIS} - t_{SLO-HYS})$: SR FET ON when meet: $V_{DRAIN} \leq V_{TH-ON}$

Gate Turn-On Blanking Time

FAN6292C supports Primary Side Regulation (PSR) operation with Discontinuous Conduction Mode (DCM) and Boundary Conduction Mode (BCM) and the typical operating of Quasi-Resonant valley switching to make the best balance between efficiency and Electro Magnetic Interference (EMI).

Together with slope detection, FAN6292C has a GATE turn on blanking time to avoid SR FET mis-triggered turn on at the first Quasi-Resonant cycle. Blanking time lengths depend on last Gate-to-Gate pulse period. The resonance period is decided by the parasitic capacitance summed at primary side and magnetizing inductance and normally is fixed once system configured but this changes as load changes, typically getting longer as load decreases. This is caused by the parasitic capacitances varies depending on voltage and stored energy at the transformer.

To corresponds this change, FAN6292C adjust minimum OFF time ($t_{OFF-MIN}$) depend on loading condition. Similar as slope detection, when t_s is shorter than $t_{SLO-DIS}$, $t_{OFF-MIN}$ becomes $t_{OFF-MIN-H}$ and when t_s is longer than $t_{SLO-DIS}$ with a hysteresis then $t_{OFF-MIN}$ becomes $t_{OFF-MIN-L}$.

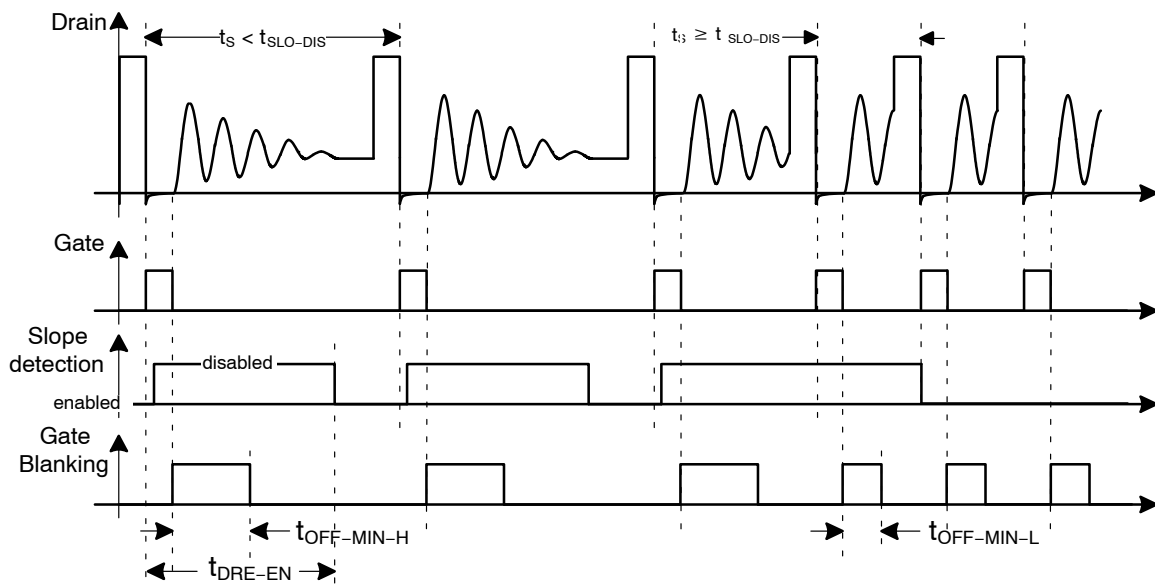

Figure 23. SR Conduction Timing Chart

Gate Turn-Off (Dead Time Self Tuning)

SR controller should turn on SR FET until the secondary discharging current become zero to avoid body diode conduction. Because the conduction loss of body diode is much higher than FET conduction loss. Therefore, the OFF dead time between SR off and magnetizing current become zero is recommended to minimized. But too small OFF dead time may raise the risk of SR FET and primary FET turn on simultaneously and too longer OFF dead time deteriorates the primary auxiliary winding voltage and gives impact on the PSR detection function. So proper value of OFF dead time is needed.

It is possible that offset voltages are induced by the stray inductance by the bonding wires inside MOSFET package and PCB layout. Therefore, it is very difficult to maintain the same OFF dead time against all the circuit tolerances and variation of operating condition. In order to control MOSFET turn off when the secondary magnetizing current is near zero, FAN6292C build-in OFF dead time self-tuning, which has adaptively changing internal turn off thresholds. The off threshold, V_{TH-OFF} , is modulated between 32 steps through internal up/down counter. FAN6292C measures OFF dead time from gate falling edge to drain voltage reaches V_{TH-HGH} and compares with internal timing threshold t_{DEAD} . When $t_{DEAD_OFF} > t_{DEAD}$ then internal counter increases one-step and gate turned off a little delayed at next switching cycle.

Start-Up Operation

FAN6292C supplies internal circuit power through VIN pin, there is integrate Low Drop Out (LDO) regulator to regulate internal voltage not exceed 5.5 V. In typical application, FAN6292C VIN pin is connect to VBUS of USB port so VIN gradually increases, FAN6292C start operation when VIN touches V_{IN-ON} and stop operation when VIN drop to V_{IN-OFF} .

Accordingly, even before FAN6292C start to working, primary side is normally working and it gives impact on the secondary side. When primary FET turns on, the voltage cross over the primary winding becomes AC input voltage and it gives secondary winding voltage based on primary and secondary turn ratio.

Once SR FET drain voltage is generated by the primary switching, the voltage will be divided by the capacitance of SR FET and some amount of voltage can be shown at the SR FET gate as in the Figure 24 and below equation.

$$V_{GS_SR} = \frac{C_{GD}}{C_{GD} + C_{GS}} \times V_{Drain} \quad (eq. 1)$$

If the divided gate voltage is higher than SR FET turn-on threshold (V_{GS_TH}) then SR FET can be turned on and this may make primary FET turn on and SR FET turn on simultaneously. In order to avoid mis-turn on SR FET, even before VIN voltage reaches V_{IN-ON} , FAN6292C pulls down the gate voltage to GND by using drain voltage.

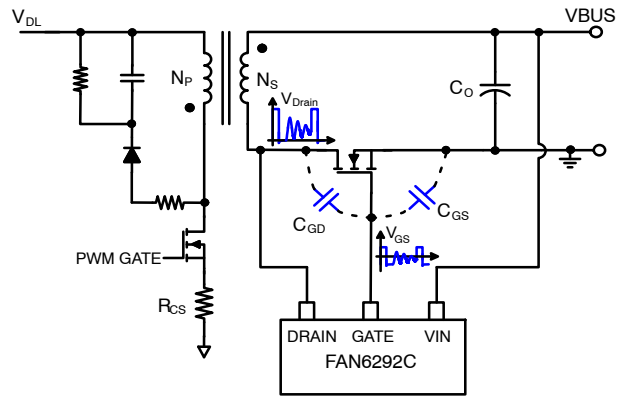

Figure 24. Gate Coupling Signal Via Practice Capacitance

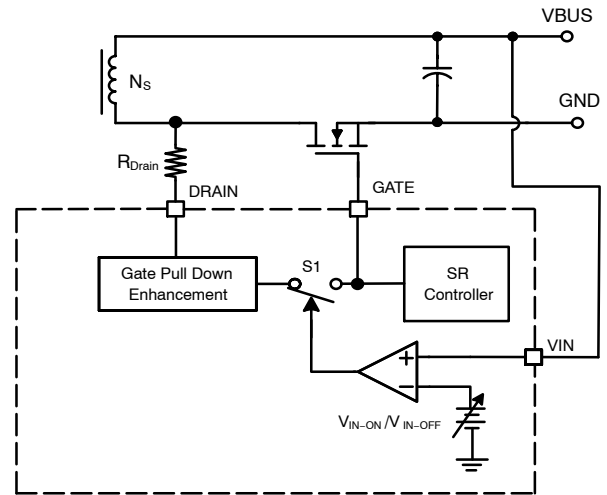

Figure 25. Gate Clamping Function Block Before FAN6292C Start-Up Operation

Dynamic Response Enhancement (DRE)

In PSR system control, the output voltage is regulated through detecting proportional voltage of auxiliary winding (VS) which is reflected from secondary winding. However VS signal can only generate and detects when primary side PWM switched. To get better standby power performance, the switching frequency is decreased to quite low frequency, the output voltage cannot be maintain as load suddenly increases from extremely light load to heavy load.

In order to enhance load transient response time when primary switching frequency is much slower, FAN6292C build-in Dynamic Response Enhancement (DRE) function that continues monitor VIN pin voltage. FAN6292C generate a sinking current pulse from Drain of MOSFET to GND when VIN pin voltage is lower than threshold V_{DRE} . The DRE sinking current which period is t_{DER1} and current level is I_{DRE} at Drain pin. The I_{DRE} current flowing loop is depicted in the Figure 26 as a blue line and this informs the primary controller that output voltage drops lower than V_{DRE} at any loading condition.

MECHANICAL CASE OUTLINE
PACKAGE DIMENSIONS

ON Semiconductor®



SOIC8
CASE 751EB
ISSUE A

DATE 24 AUG 2017

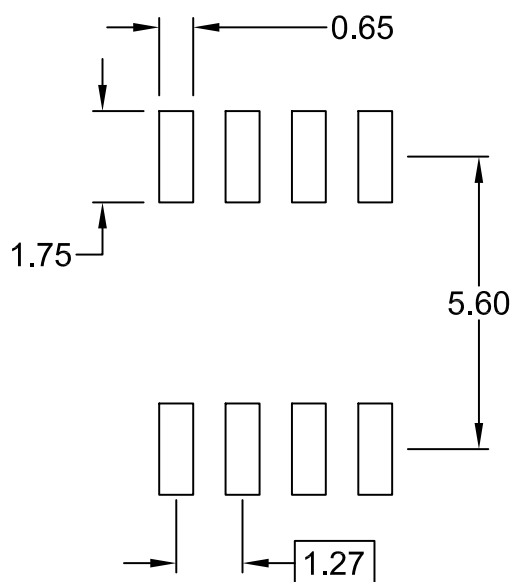

⊕ 0.25 (M) C B A

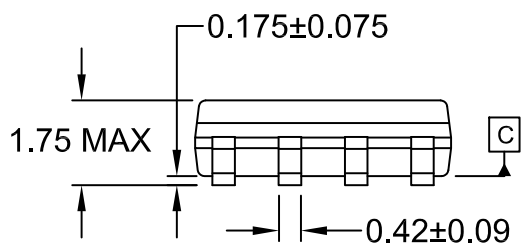

⌒ 0.10

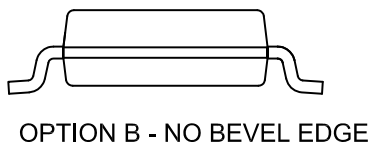
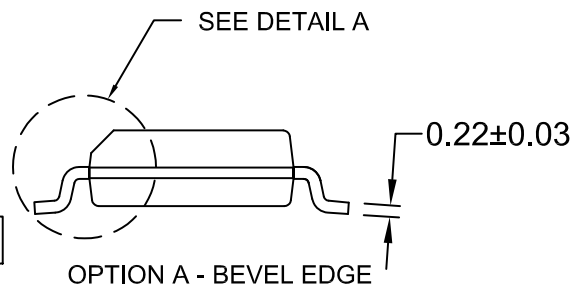

NOTES:

- A) THIS PACKAGE CONFORMS TO JEDEC MS-012, VARIATION AA.
- B) ALL DIMENSIONS ARE IN MILLIMETERS.
- C) DIMENSIONS DO NOT INCLUDE MOLD FLASH OR BURRS.
- D) LANDPATTERN STANDARD: SOIC127P600X175-8M

DOCUMENT NUMBER:	98AON13735G	Electronic versions are uncontrolled except when accessed directly from the Document Repository. Printed versions are uncontrolled except when stamped "CONTROLLED COPY" in red.
DESCRIPTION:	SOIC8	PAGE 1 OF 1

ON Semiconductor and are trademarks of Semiconductor Components Industries, LLC dba ON Semiconductor or its subsidiaries in the United States and/or other countries. ON Semiconductor reserves the right to make changes without further notice to any products herein. ON Semiconductor makes no warranty, representation or guarantee regarding the suitability of its products for any particular purpose, nor does ON Semiconductor assume any liability arising out of the application or use of any product or circuit, and specifically disclaims any and all liability, including without limitation special, consequential or incidental damages. ON Semiconductor does not convey any license under its patent rights nor the rights of others.

onsemi, **Onsemi**, and other names, marks, and brands are registered and/or common law trademarks of Semiconductor Components Industries, LLC dba "**onsemi**" or its affiliates and/or subsidiaries in the United States and/or other countries. **onsemi** owns the rights to a number of patents, trademarks, copyrights, trade secrets, and other intellectual property. A listing of **onsemi**'s product/patent coverage may be accessed at www.onsemi.com/site/pdf/Patent-Marking.pdf. **onsemi** reserves the right to make changes at any time to any products or information herein, without notice. The information herein is provided "as-is" and **onsemi** makes no warranty, representation or guarantee regarding the accuracy of the information, product features, availability, functionality, or suitability of its products for any particular purpose, nor does **onsemi** assume any liability arising out of the application or use of any product or circuit, and specifically disclaims any and all liability, including without limitation special, consequential or incidental damages. Buyer is responsible for its products and applications using **onsemi** products, including compliance with all laws, regulations and safety requirements or standards, regardless of any support or applications information provided by **onsemi**. "Typical" parameters which may be provided in **onsemi** data sheets and/or specifications can and do vary in different applications and actual performance may vary over time. All operating parameters, including "Typicals" must be validated for each customer application by customer's technical experts. **onsemi** does not convey any license under any of its intellectual property rights nor the rights of others. **onsemi** products are not designed, intended, or authorized for use as a critical component in life support systems or any FDA Class 3 medical devices or medical devices with a same or similar classification in a foreign jurisdiction or any devices intended for implantation in the human body. Should Buyer purchase or use **onsemi** products for any such unintended or unauthorized application, Buyer shall indemnify and hold **onsemi** and its officers, employees, subsidiaries, affiliates, and distributors harmless against all claims, costs, damages, and expenses, and reasonable attorney fees arising out of, directly or indirectly, any claim of personal injury or death associated with such unintended or unauthorized use, even if such claim alleges that **onsemi** was negligent regarding the design or manufacture of the part. **onsemi** is an Equal Opportunity/Affirmative Action Employer. This literature is subject to all applicable copyright laws and is not for resale in any manner.

PUBLICATION ORDERING INFORMATION

LITERATURE FULFILLMENT:

Email Requests to: orderlit@onsemi.com

onsemi Website: www.onsemi.com

TECHNICAL SUPPORT

North American Technical Support:

Voice Mail: 1 800-282-9855 Toll Free USA/Canada

Phone: 011 421 33 790 2910

Europe, Middle East and Africa Technical Support:

Phone: 00421 33 790 2910

For additional information, please contact your local Sales Representative