



# Dual USB Switch with Fault Blanking and Autoreset

## General Description

The MAX1823 is a dual, current-limited switch with autoreset specifically made for USB applications. The autoreset feature latches the switch off if the output is shorted, saving system power. The switch reactivates when the short circuit is removed. Each channel is guaranteed to supply 720mA and meet USB specifications. Low quiescent supply current (50 $\mu$ A) and standby current (3 $\mu$ A) conserve battery power in portable applications.

The MAX1823 has multiple safety features to ensure that the USB port is protected. Built-in thermal-overload protection limits power dissipation and junction temperature. Accurate internal current-limiting circuitry protects the input supply against both overload and short-circuit conditions. Independent fault signals (FAULTA and FAULTB) notify the microprocessor ( $\mu$ P) when a thermal-overload, current-limit, undervoltage-lockout (UVLO), or short-circuit fault occurs. A 20ms fault-blanking feature ignores momentary faults, such as those caused when hot swapping a capacitive load, preventing false alarms to the host system. The MAX1823A/MAX1823B also block reverse current (current from OUT\_ to IN\_) while in shutdown.

The MAX1823 is available in a space-saving 10-pin  $\mu$ MAX package. The MAX1823/MAX1823A are enabled with an active-low signal, and the MAX1823B/MAX1823H are enabled with an active-high signal. For a single version of this device, refer to the MAX1946 data sheet. For a triple version, refer to the MAX1940 data sheet.

## Applications

USB Ports and Hubs  
Notebook and Desktop Computers  
PDAs and Palmtop Computers  
Docking Stations

## Pin Configuration

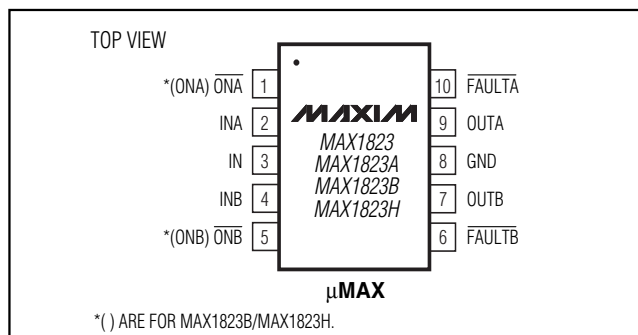

## Features

- ◆ Dual USB Switch in Tiny 10-Pin  $\mu$ MAX Package
- ◆ Autoreset Feature Saves Power
- ◆ Guaranteed 720mA Load per Channel
- ◆ Built-In 20ms Fault Blanking
- ◆ Compliant to USB Specification
- ◆ Blocks Reverse Current in Shutdown (MAX1823A/MAX1823B)
- ◆ 4V to 5.5V Input Voltage Range
- ◆ Independent Shutdown Control (MAX1823/MAX1823A—Active Low) (MAX1823B/MAX1823H—Active High)
- ◆ Independent  $\overline{\text{FAULT}}$  Indicator Outputs
- ◆ Thermal-Overload Protection
- ◆ 50 $\mu$ A Quiescent Current (Both Switches On)
- ◆ 3 $\mu$ A Standby Current
- ◆ UL Recognized

## Ordering Information

| PART        | TEMP RANGE     | PIN-PACKAGE  |
|-------------|----------------|--------------|
| MAX1823EUB  | -40°C to +85°C | 10 $\mu$ MAX |
| MAX1823AEUB | -40°C to +85°C | 10 $\mu$ MAX |
| MAX1823BEUB | -40°C to +85°C | 10 $\mu$ MAX |
| MAX1823HEUB | -40°C to +85°C | 10 $\mu$ MAX |

## Typical Operating Circuit

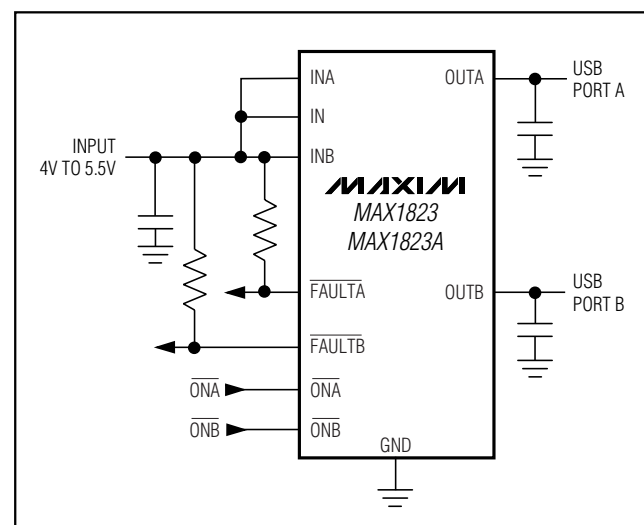

# Dual USB Switch with Fault Blanking and Autoreset

## ABSOLUTE MAXIMUM RATINGS

IN, INA, INB,  $\overline{\text{ONA}}$ ,  $\overline{\text{ONB}}$ , ONA, ONB  
 OUTA, OUTB to GND .....-0.3V to +6V  
 $\overline{\text{FAULTA}}$ ,  $\overline{\text{FAULTB}}$  to GND.....-0.3V to ( $V_{\text{IN}_-} + 0.3\text{V}$ )  
 MAX1823/MAX1823H, INA, IN to OUTA;  
 INB, IN to OUTB .....-0.3V to +6V  
 MAX1823A/MAX1823B, INA, IN to OUTA;  
 INB, IN to OUTB (when disabled, Note 3).....-6V to +6V  
 INA, IN to OUTA; INB, IN to OUTB  
 (when enabled, Note 4).....-1.5A to +1.5A<sub>RMS</sub>

$\overline{\text{FAULTA}}$ ,  $\overline{\text{FAULTB}}$  Current .....20mA  
 Continuous Power Dissipation ( $T_A = +70^\circ\text{C}$ )  
 10-Pin  $\mu\text{MAX}$  (derate 5.6mW/ $^\circ\text{C}$  above  $+70^\circ\text{C}$ ) .....444mW  
 Operating Temperature Range .....-40 $^\circ\text{C}$  to +85 $^\circ\text{C}$   
 Junction Temperature .....+150 $^\circ\text{C}$   
 Storage Temperature Range .....-65 $^\circ\text{C}$  to +150 $^\circ\text{C}$   
 Lead Temperature (soldering, 10s) .....+300 $^\circ\text{C}$

Stresses beyond those listed under "Absolute Maximum Ratings" may cause permanent damage to the device. These are stress ratings only, and functional operation of the device at these or any other conditions beyond those indicated in the operational sections of the specifications is not implied. Exposure to absolute maximum rating conditions for extended periods may affect device reliability.

## ELECTRICAL CHARACTERISTICS

(Circuit of Figure 1,  $V_{\text{IN}} = V_{\text{INA}} = V_{\text{INB}} = 5\text{V}$ ,  $\overline{\text{ONA}} = \overline{\text{ONB}} = \text{GND}$  (MAX1823/MAX1823A), ONA = ONB = IN (MAX1823B/MAX1823H),  $T_A = 0^\circ\text{C}$  to +85 $^\circ\text{C}$ , unless otherwise noted. Typical values are at  $T_A = +25^\circ\text{C}$ .)

| PARAMETER                            | SYMBOL             | CONDITIONS   | MIN  | TYP  | MAX   | UNITS             |
|--------------------------------------|--------------------|--|------|------|-------|-------------------|
| Supply Voltage Range                 |                    |  | 4.0  |      | 5.5   | V                 |
| Switch On-Resistance                 | $R_{\text{ON}}$    | $T_A = +25^\circ\text{C}$ , each switch,<br>MAX1823/MAX1823H   |      | 75   | 105   | m $\Omega$        |
|                                      |                    | $T_A = +25^\circ\text{C}$ , each switch,<br>MAX1823A/MAX1823B  |      | 90   | 120   |                   |
|                                      |                    | $T_A = 0^\circ\text{C}$ to +85 $^\circ\text{C}$ , each switch,<br>MAX1823/MAX1823H   |      |      | 135   |                   |
|                                      |                    | $T_A = 0^\circ\text{C}$ to +85 $^\circ\text{C}$ , each switch,<br>MAX1823A/MAX1823B  |      |      | 165   |                   |
| Standby Supply Current               |                    | $\overline{\text{ON}}_- = \text{IN}_-$ (MAX1823/MAX1823A), $\text{ON}_- = \text{GND}$ (MAX1823B/MAX1823H)  |      | 3    | 10    | $\mu\text{A}$     |
| Quiescent Supply Current             |                    | $I_{\text{OUTA}} = I_{\text{OUTB}} = 0\text{A}$ , one channel on   |      | 40   | 80    | $\mu\text{A}$     |
|                                      |                    | $I_{\text{OUTA}} = I_{\text{OUTB}} = 0\text{A}$ , both channels on   |      | 50   | 100   |                   |
| OUT <sub>-</sub> Off-Leakage Current |                    | $\overline{\text{ON}}_- = \text{IN}_-$ (MAX1823/MAX1823A), $\text{ON}_- = \text{GND}$ (MAX1823B/MAX1823H), $V_{\text{OUTA}} = V_{\text{OUTB}} = 0\text{V}$ , $T_A = +25^\circ\text{C}$                       |      | 0.02 | 1.00  | $\mu\text{A}$     |
|                                      |                    | $\overline{\text{ON}}_- = \text{IN}_-$ (MAX1823/MAX1823A), $\text{ON}_- = \text{GND}$ (MAX1823B/MAX1823H), $V_{\text{OUTA}} = V_{\text{OUTB}} = 0\text{V}$ , $T_A = 0^\circ\text{C}$ to +85 $^\circ\text{C}$ |      | 0.02 | 10.00 |                   |
| Undervoltage-Lockout Threshold       | $V_{\text{UVLO}}$  | Rising edge, 3% hysteresis   | 3.0  | 3.4  | 3.8   | V                 |
| Continuous Load Current              |                    |  | 720  |      |       | mA                |
| Continuous Current Limit             | $I_{\text{LIM}}$   | $V_{\text{IN}} - V_{\text{OUT}_-} = 0.5\text{V}$   | 0.72 | 0.90 | 1.20  | A                 |
| Short-Circuit Current Limit          | $I_{\text{SHORT}}$ | $V_{\text{OUT}_-} = 0\text{V}$ ( $I_{\text{OUT}}$ pulsing)   | 0.8  | 1.2  | 1.6   | A <sub>PEAK</sub> |
|                                      |                    | $V_{\text{OUT}_-} = 0\text{V}$ ( $I_{\text{OUT}}$ pulsing)   |      | 0.35 |       | A <sub>RMS</sub>  |

# Dual USB Switch with Fault Blanking and Autoreset

MAX1823/MAX1823A/MAX1823B/MAX1823H

## ELECTRICAL CHARACTERISTICS (continued)

(Circuit of Figure 1,  $V_{IN} = V_{INA} = V_{INB} = 5V$ ,  $\overline{ON}_A = \overline{ON}_B = GND$  (MAX1823/MAX1823A),  $ON_A = ON_B = IN$  (MAX1823B/MAX1823H),  $T_A = 0^\circ\text{C}$  to  $+85^\circ\text{C}$ , unless otherwise noted. Typical values are at  $T_A = +25^\circ\text{C}$ .)

| PARAMETER  | SYMBOL     | CONDITIONS   | MIN              | TYP  | MAX  | UNITS         |
|--|------------|--|------------------|------|------|---------------|
| Short-Circuit Detect Threshold                   |            | (Note 1)   |                  | 1    |      | V             |
| Continuous Current-Limit Blanking Timeout Period |            | From continuous current-limit condition to $\overline{FAULT}_-$ assertion  | 10               | 20   | 35   | ms            |
| Short-Circuit Blanking Timeout Period            |            | From short-circuit current-limit condition to $\overline{FAULT}_-$ assertion   | 7.5              | 18   | 35.0 | ms            |
| Turn-On Delay                                    | $t_{ON}$   | $R_{OUT\_} = 10k\Omega$ , does not include rise time   |                  |      |      | ms            |
|  |            |  | MAX1823/MAX1823H | 0.5  | 1.2  |               |
|  |            |  |                  |      |      |               |
|  |            |  |                  |      |      |               |
|  |            |  |                  |      |      |               |
|  |            |  |                  |      |      |               |
| Output Rise Time                                 | $t_{RISE}$ | $R_{OUT\_} = 10\Omega$ , from 10% to 90% of $V_{OUT\_}$  |                  | 2.5  |      | ms            |
| Turn-Off Delay from ON                           | $t_{OFF}$  | $R_{OUT\_} = 10\Omega$ , does not include fall time (from $\overline{ON}_-$ (MAX1823) or $ON_-$ (MAX1823H) deasserted to $V_{OUT} = 90\%$ of $V_{IN\_}$ )  |                  | 0.8  | 3.0  | ms            |
|  |            | $R_{OUT\_} = 10\Omega$ , does not include fall time (from $\overline{ON}_-$ (MAX1823A) or $ON_-$ (MAX1823B) deasserted to $V_{OUT} = 90\%$ of $V_{IN\_}$ ) |                  | 0.1  | 3.0  |               |
| Output Fall Time                                 | $t_{FALL}$ | $R_{OUT\_} = 10\Omega$ , from 90% to 10% of $V_{OUT_-}$ (MAX1823/MAX1823H)   |                  | 2.5  |      | ms            |
|  |            | $R_{OUT\_} = 10\Omega$ , from 90% to 10% of $V_{OUT_-}$ (MAX1823A/MAX1823B)  |                  | 2.8  |      |               |
| Thermal-Shutdown Threshold                       |            | 15°C hysteresis  |                  | +160 |      | °C            |
| Logic Input High Voltage                         |            | $V_{IN\_} = 4V$ to 5.5V  | 2                |      |      | V             |
| Logic Input Low Voltage                          |            | $V_{IN\_} = 4V$ to 5.5V  |                  |      | 0.8  | V             |
| Logic Input Current                              |            | $\overline{ON}_- = GND$ or $IN_-$ (MAX1823/MAX1823A), $ON_- = GND$ or $IN_-$ (MAX1823B/MAX1823H)   | -1               |      | +1   | $\mu\text{A}$ |
| $\overline{FAULT}_-$ Output Low Voltage          |            | $I_{SINK} = 1\text{mA}$ , $V_{IN\_} = 4V$  |                  |      | 0.4  | V             |
| $\overline{FAULT}_-$ Output High Leakage Current |            | $V_{IN\_} = V_{\overline{FAULT}_-} = 5.5V$   |                  |      | 1    | $\mu\text{A}$ |
| Autoreset $OUT_-$ Current                        |            | In latched-off state, $V_{OUT_-} = 0V$   | 10               | 30   | 45   | mA            |
| Autoreset Threshold                              |            | In latched-off state, rising   | 0.4              | 0.5  | 0.6  | V             |
| Autoreset Blanking Time                          |            | In latched-off state, $V_{OUT_-} > 0.5V$   | 10               | 20   | 35   | ms            |

# Dual USB Switch with Fault Blanking and Autoreset

## ELECTRICAL CHARACTERISTICS

(Circuit of Figure 1,  $V_{IN} = V_{IN\_} = V_{ON\_} = 5V$  (MAX1823B/MAX1823H);  $V_{IN} = V_{IN\_} = 5V$ ,  $ON\_ = GND$  (MAX1823/MAX1823A),  $T_A = -40^{\circ}C$  to  $+85^{\circ}C$ , unless otherwise noted.) (Note 2)

| PARAMETER  | SYMBOL      | CONDITIONS   | MIN               | TYP | MAX  | UNITS             |
|--|-------------|--|-------------------|-----|------|-------------------|
| Supply Voltage Range                             |             |  | 4.0               |     | 5.5  | V                 |
| Switch On-Resistance                             | $R_{ON}$    | Each switch, MAX1823/MAX1823H  |                   |     | 135  | m $\Omega$        |
|  |             | Each switch, MAX1823A/MAX1823B   |                   |     | 165  |                   |
| Standby Supply Current                           |             | $\overline{ON\_} = IN\_ (MAX1823/MAX1823A)$ ,<br>$ON\_ = GND (MAX1823B/MAX1823H)$  |                   |     | 10   | $\mu A$           |
| Quiescent Supply Current                         |             | $I_{OUTA} = I_{OUTB} = 0A$ , one channel on  |                   |     | 80   | $\mu A$           |
|  |             | $I_{OUTA} = I_{OUTB} = 0A$ , both channels on  |                   |     | 100  |                   |
| OUT_ Off-Leakage Current                         |             | $\overline{ON\_} = IN\_ (MAX1823/MAX1823A)$ ,<br>$ON\_ = GND (MAX1823B/MAX1823H)$ ,<br>$V_{OUTA} = V_{OUTB} = 0V$  |                   |     | 10   | $\mu A$           |
| Undervoltage-Lockout Threshold                   | $V_{UVLO}$  | Rising edge, 3% hysteresis   | 3.0               |     | 3.8  | V                 |
| Continuous Load Current                          |             |  | 720               |     |      | mA                |
| Continuous Current Limit                         | $I_{LIM}$   | $V_{IN\_} - V_{OUT\_} = 0.5V$  | 0.72              |     | 1.20 | A                 |
| Current Limit into Short Circuit                 | $I_{SHORT}$ | $V_{OUT\_} = 0V$ ( $I_{OUT}$ pulsing)  | 0.8               |     | 1.6  | A <sub>PEAK</sub> |
| Continuous Current-Limit Blanking Timeout Period |             | From continuous current-limit condition to $\overline{FAULT\_}$ assertion  | 10                |     | 35   | ms                |
| Short-Circuit Blanking Timeout Period            |             | From short-circuit current-limit condition to $\overline{FAULT\_}$ assertion   | 7.5               |     | 35.0 | ms                |
| Turn-On Delay                                    | $t_{ON}$    | $R_{OUT\_} = 10k\Omega$ , does not include rise time   | MAX1823/MAX1823H  | 0.5 | 4.0  | ms                |
|  |             |  | MAX1823A/MAX1823B | 0.3 | 3.0  |                   |
| Turn-Off Delay from ON                           | $t_{OFF}$   | $R_{OUT\_} = 10\Omega$ , does not include fall time (from $\overline{ON\_} (MAX1823/MAX1823A)$ or $ON\_ (MAX1823B/MAX1823H)$ deasserted to $V_{OUT\_} = 90\% V_{IN\_}$ ) |                   |     | 3    | ms                |

# Dual USB Switch with Fault Blanking and Autoreset

MAX1823/MAX1823A/MAX1823B/MAX1823H

## ELECTRICAL CHARACTERISTICS (continued)

(Circuit of Figure 1,  $V_{IN} = V_{IN\_} = V_{ON\_} = 5V$  (MAX1823B/MAX1823H);  $V_{IN} = V_{IN\_} = 5V$ ,  $ON\_ = GND$  (MAX1823/MAX1823A),  $T_A = -40^{\circ}C$  to  $+85^{\circ}C$ , unless otherwise noted.) (Note 2)

| PARAMETER                          | SYMBOL | CONDITIONS                               | MIN | TYP | MAX | UNITS   |
|------------------------------------|--------|--|-----|-----|-----|---------|
| Logic Input High Voltage           |        | $V_{IN\_} = 4V$ to $5.5V$                | 2   |     |     | V       |
| Logic Input Low Voltage            |        | $V_{IN\_} = 4V$ to $5.5V$                |     |     | 0.8 | V       |
| Logic Input Current                |        | $V_{ON\_} = 0V$ or $V_{IN\_}$            | -1  |     | +1  | $\mu A$ |
| FAULT_ Output Low Voltage          |        | $I_{SINK} = 1mA$ , $V_{IN\_} = 4V$       |     |     | 0.4 | V       |
| FAULT_ Output High Leakage Current |        | $V_{IN\_} = V_{FAULT\_} = 5.5V$          |     |     | 1   | $\mu A$ |
| Autoreset OUT_Current              |        | In latched-off state, $V_{OUT\_} = 0V$   | 10  |     | 50  | mA      |
| Autoreset Threshold                |        | In latched-off state, rising             | 0.4 |     | 0.6 | V       |
| Autoreset Blanking Time            |        | In latched-off state, $V_{OUT\_} > 0.5V$ | 10  |     | 35  | ms      |

**Note 1:** The output voltage at which the device transitions from short-circuit current limit to continuous current limit.

**Note 2:** Specifications to  $-40^{\circ}C$  are guaranteed by design, not production tested.

**Note 3:** Reverse current (current from  $OUT\_$  to  $IN\_$ ) is blocked when disabled.

**Note 4:** Forward current (current from  $IN\_$  to  $OUT\_$ ) is internally limited. Reverse current, from  $OUT\_$  to  $IN\_$ , is not limited when the device is enabled and must be kept below  $1.5A_{RMS}$  to prevent permanent device damage. When the MAX1823A/MAX1823B are disabled, the switch turns off and reverse current is internally blocked.

## Typical Operating Characteristics

(Circuit of Figure 1,  $V_{IN} = V_{INA} = V_{INB} = 5V$ ,  $ON\_ = GND$  (MAX1823/MAX1823A),  $ON\_ = IN\_$  (MAX1823B/MAX1823H),  $T_A = +25^{\circ}C$ , unless otherwise noted.)

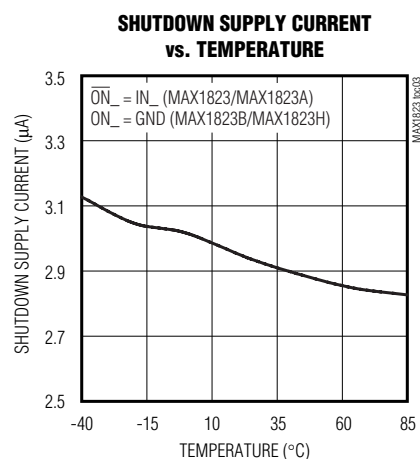
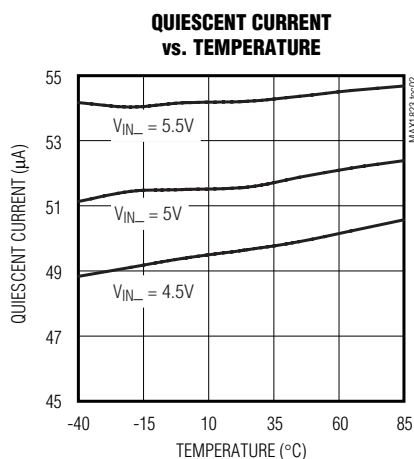
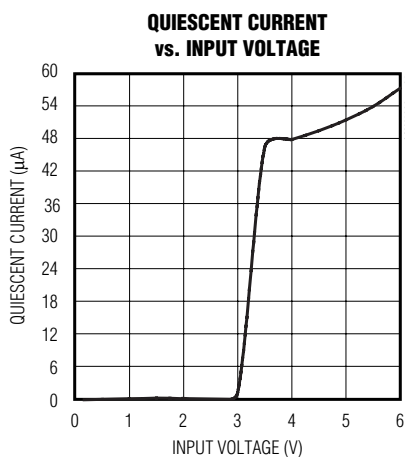

# Dual USB Switch with Fault Blanking and Autoreset

## Typical Operating Characteristics (continued)

(Circuit of Figure 1,  $V_{IN} = V_{INA} = V_{INB} = 5V$ ,  $\overline{ON}_- = GND$  (MAX1823/MAX1823A),  $ON_- = IN_-$  (MAX1823B/MAX1823H),  $T_A = +25^\circ C$ , unless otherwise noted.)

**SWITCH OFF-LEAKAGE vs. TEMPERATURE**

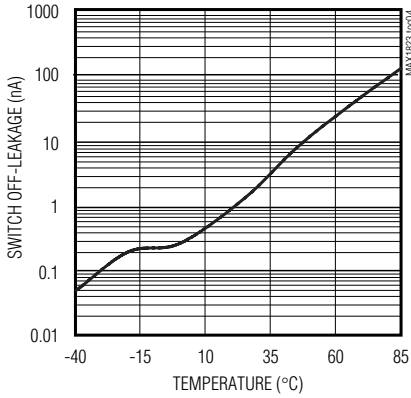

**NORMALIZED  $R_{ON}$  vs. TEMPERATURE**

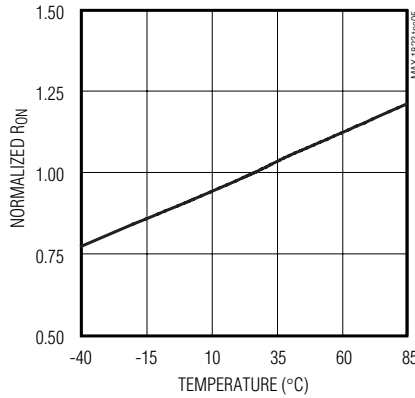

**CONTINUOUS CURRENT-LIMIT THRESHOLD vs. TEMPERATURE**

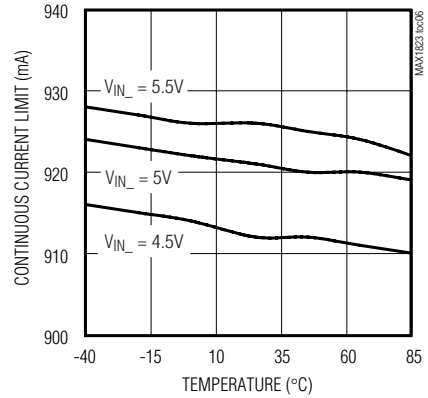

**TURN-ON TIME vs. TEMPERATURE ( $t_{ON} + t_{RISE}$ )**

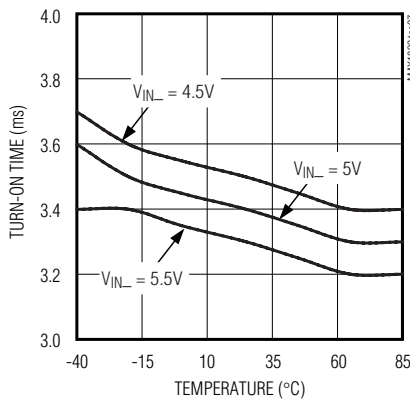

**TURN-OFF TIME vs. TEMPERATURE ( $t_{OFF} + t_{FALL}$ )**

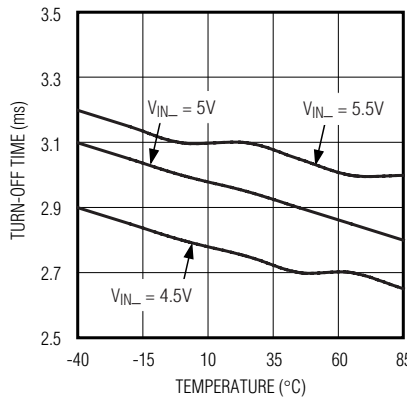

**FAULT-BLANKING TIME vs. TEMPERATURE**

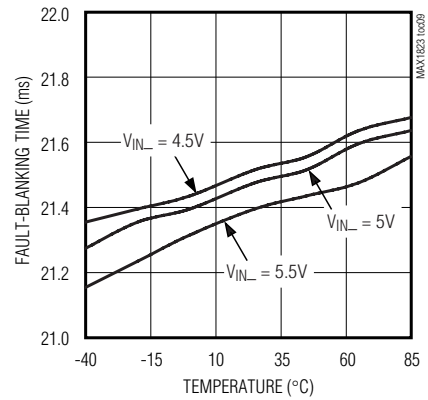

**FAULT\_ OUTPUT LOW VOLTAGE vs. TEMPERATURE**

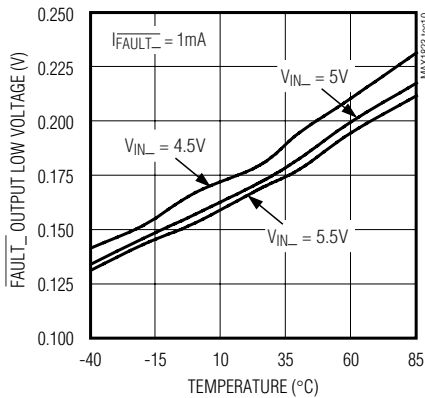

**AUTORESET CURRENT vs. TEMPERATURE (MAX1823/MAX1823H)**

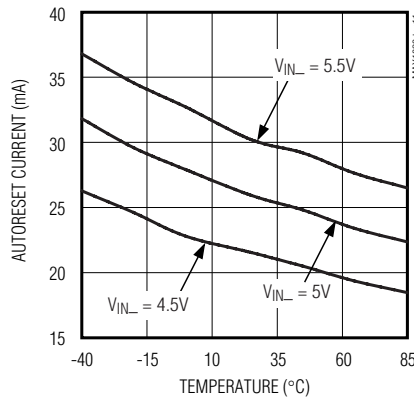

**AUTORESET CURRENT vs. TEMPERATURE (MAX1823A/MAX1823B)**

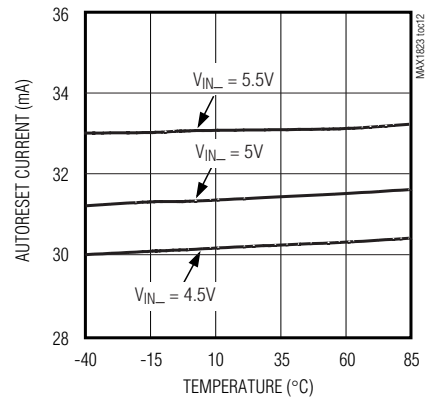

# Dual USB Switch with Fault Blanking and Autoreset

## Typical Operating Characteristics (continued)

(Circuit of Figure 1,  $V_{IN} = V_{INA} = V_{INB} = 5V$ ,  $\overline{ON}_- = GND$  (MAX1823/MAX1823A),  $ON_- = IN_-$  (MAX1823B/MAX1823H),  $T_A = +25^\circ C$ , unless otherwise noted.)

**AUTORESET CURRENT vs. INPUT VOLTAGE (MAX1823/MAX1823H)**

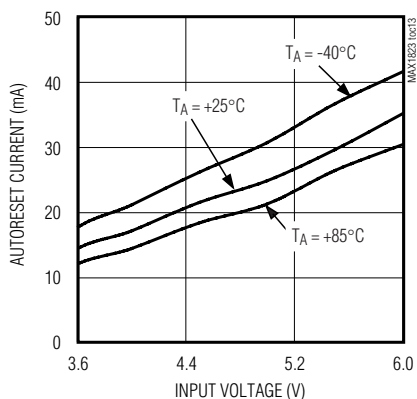

**AUTORESET CURRENT vs. INPUT VOLTAGE (MAX1823A/MAX1823B)**

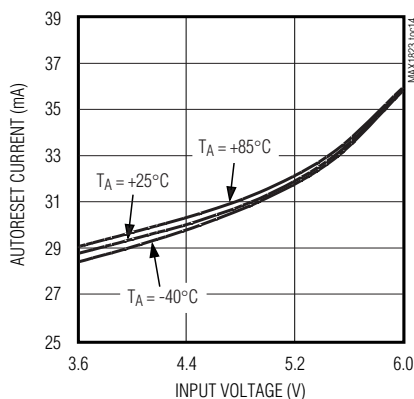

**OVERLOAD RESPONSE INTO 2.5Ω (MAX1823/MAX1823H)**

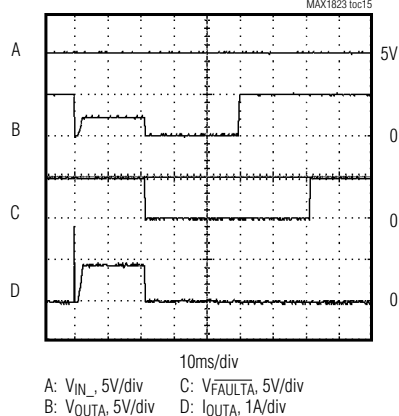

**OVERLOAD RESPONSE INTO 2.5Ω (MAX1823A/MAX1823B ONLY)**

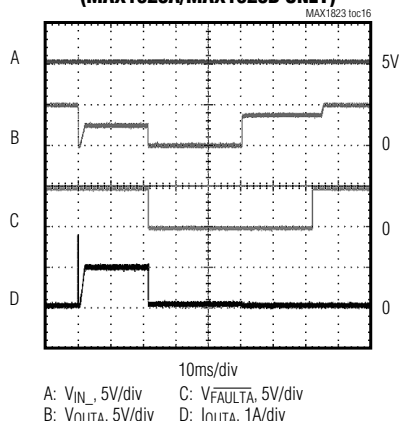

**OVERLOAD RESPONSE INTO 2.5Ω (EXPANDED TIME SCALE)**

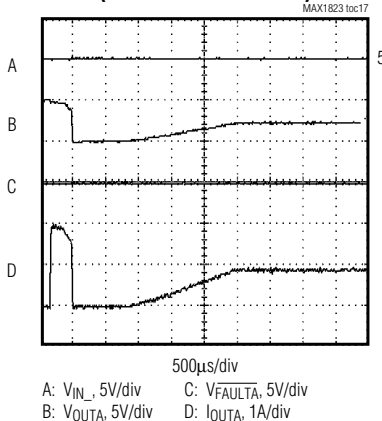

**SHORT-CIRCUIT RESPONSE INTO 0Ω (MAX1823/MAX1823H)**

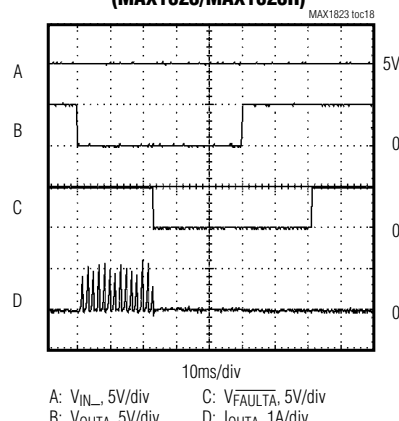

**SHORT-CIRCUIT RESPONSE INTO 0Ω (MAX1823A/MAX1823B)**

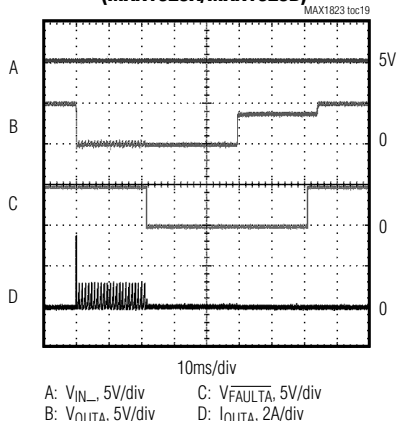

**SHORT-CIRCUIT RESPONSE INTO 0Ω (EXPANDED TIME SCALE)**

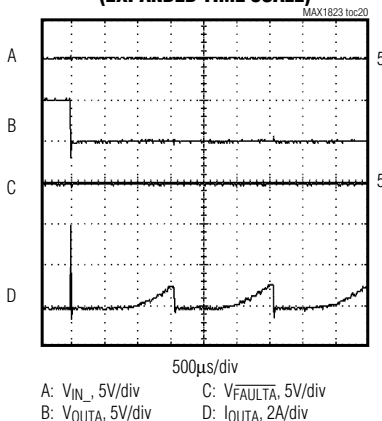

**SWITCH TURN-ON TIME (MAX1823/MAX1823A)**

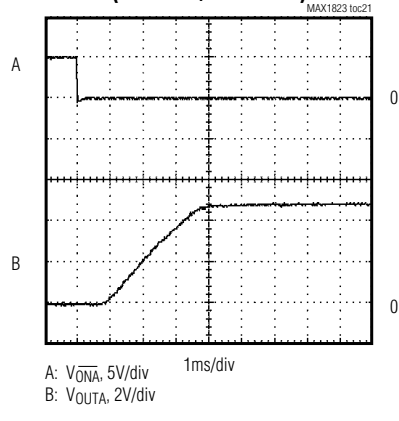

MAX1823/MAX1823A/MAX1823B/MAX1823H

# Dual USB Switch with Fault Blanking and Autoreset

## Typical Operating Characteristics (continued)

(Circuit of Figure 1,  $V_{IN} = V_{INA} = V_{INB} = 5V$ ,  $\overline{ON}_- = GND$  (MAX1823/MAX1823A),  $ON_- = IN_-$  (MAX1823B/MAX1823H),  $T_A = +25^\circ C$ , unless otherwise noted.)

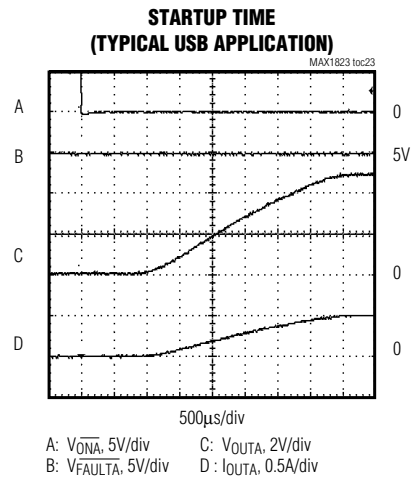
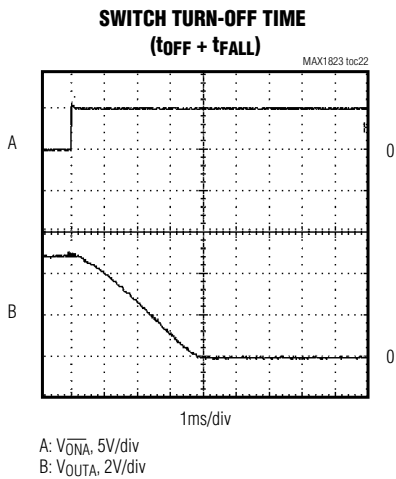

## Pin Description

| PIN     | NAME                       | FUNCTION   |
|---------|----------------------------|--|
| 1       | $\overline{ON}A$<br>*(ONA) | Control Input for Switch A. Can be driven higher than $IN_-$ without damage. A logic low turns switch A on for the MAX1823/MAX1823A, and a logic high turns switch A on for the MAX1823B/MAX1823H. |
| 2, 3, 4 | INA, IN,<br>INB            | Power Input. Connect all $IN_-$ pins together, and bypass with a 0.1µF capacitor to ground. Load conditions may require additional bulk capacitance to prevent the input from being pulled down.   |
| 5       | $\overline{ON}B$<br>*(ONB) | Control Input for Switch B. Can be driven higher than $IN_-$ without damage. A logic low turns switch B on for the MAX1823/MAX1823A, and a logic high turns switch B on for the MAX1823B/MAX1823H. |
| 6       | $\overline{FAULT}B$        | Fault-Indicator Output for Switch B. This open-drain output goes low when switch B is in thermal shutdown or UVLO or in a sustained (>20ms) current-limit or short-circuit condition.              |
| 7       | OUTB                       | Power Output for Switch B. Connect a 1µF capacitor from OUTB to ground. Load condition may require additional bulk capacitance.  |
| 8       | GND                        | Ground   |
| 9       | OUTA                       | Power Output for Switch A. Connect a 1µF capacitor from OUTA to ground. Load condition may require additional bulk capacitance.  |
| 10      | $\overline{FAULT}A$        | Fault-Indicator Output for Switch A. This open-drain output goes low when switch A is in thermal shutdown or UVLO or in a sustained (>20ms) current-limit or short-circuit condition.              |

\*( ) are for the MAX1823B/MAX1823H only.



# Dual USB Switch with Fault Blanking and Autoreset

## Detailed Description

The MAX1823 is a dual, current-limited switch designed for USB applications. It has two independent switches, each with its own enable control input and autoreset function. Each switch has an error-flag output to notify the USB controller when the current-limit, short-circuit, undervoltage-lockout, or thermal-shutdown threshold is reached (Figure 2).

The MAX1823 operates from a 4V to 5.5V input voltage range and guarantees a minimum 720mA output current. A built-in 0.9A current limit limits the current in the event of a heavy-overload condition. The MAX1823 has independent thermal shutdown for each switch in the event of a prolonged overload or short-circuit condition. The autoreset function monitors the overload and automatically turns the switch on when the overload is removed.

Use of low- $R_{ON}$  NMOS switches enables the MAX1823 to provide two switches in the ultra-small 10-pin  $\mu$ MAX package. An internal micropower charge pump generates the high-side supply needed for driving the gates of these high-side switches. Separate current-limiting and thermal-shutdown circuits permit each switch to operate independently, improving system robustness.

## Undervoltage-Lockout and Input-Voltage Requirements

The MAX1823 includes a UVLO circuit to prevent erroneous switch operation when the input voltage goes low during startup and brownout conditions. Operation is inhibited when  $V_{IN\_}$  is less than 3.4V.

## Output Fault Protection

The MAX1823 senses the switch output voltage and selects continuous current limiting when  $V_{OUT}$  is greater than 1V or short-circuit current limiting when  $V_{OUT}$  is less than 1V. When  $V_{OUT}$  is greater than 1V, the device operates in a continuous current-limit mode that sets the output current limit to 0.9A. When  $V_{OUT}$  is less than 1V, the device operates in short-circuit current-limit mode, sourcing 0.35A<sub>RMS</sub> current pulses to the load.

## Autoreset Mode

If an output fault is detected for more than the 20ms blanking time, the output latches off, the  $\overline{FAULT\_}$  output goes low, and a 25mA current is forced at the output. If the voltage on the output exceeds 0.5V for 20ms, the fault resets, the 25mA current source shuts down, and the output turns on. The device monitors the output voltage so that a short-circuit condition can be detected. Active loads are not expected to have measurable currents when the supply is below 0.5V. The MAX1823/MAX1823A can also be reset from fault manually by toggling  $\overline{ON\_}$  ( $\overline{ON\_}$  for the MAX1823B/MAX1823H) for that channel.

## Thermal Shutdown

The MAX1823 features independent thermal shutdown for each switch channel, allowing one switch to deliver power even if the other switch has a fault condition. When the junction temperature exceeds +160°C, the switch turns off and the  $\overline{FAULT\_}$  output goes low immediately; fault blanking does not occur during thermal limit. When the junction cools by 15°C, the switch turns on again. If the fault overload condition continues, the switch cycles on and off, resulting in a pulsed output, saving battery power.

## Reverse Current Blocking

The USB specification does not allow an output device to source current back into the USB port. However, the MAX1823A/MAX1823B are designed to safely power noncompliant devices. When disabled, each output is switched to a high-impedance state, blocking reverse current flow from the output back to the input. However, during normal operation with the device enabled, the MAX1823A/MAX1823B are bidirectional switches.

## Fault Indicators

The MAX1823 provides an open-drain fault output ( $\overline{FAULT\_}$ ) for each switch. For most applications, connect  $\overline{FAULT\_}$  to  $\overline{IN\_}$  through a 100k $\Omega$  pullup resistor.  $\overline{FAULT\_}$  goes low when any of the following conditions occur:

- The input voltage is below the UVLO threshold.
- The switch junction temperature exceeds the +160°C thermal-shutdown temperature limit.
- The switch is in current-limit or short-circuit limit mode after the fault-blanking period is exceeded.
- The switch is in autoreset mode.

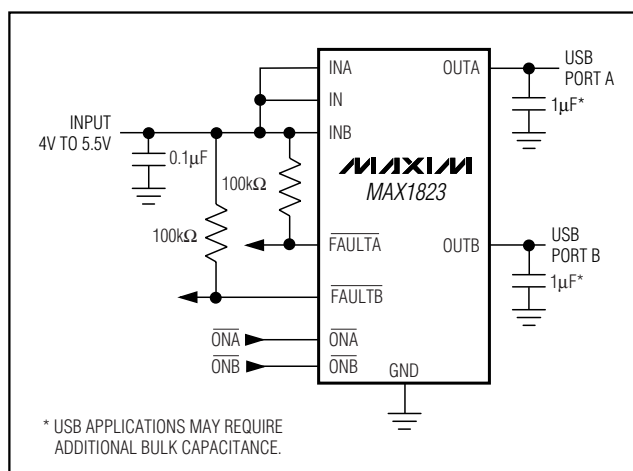

Figure 1. Typical Application Circuit

# Dual USB Switch with Fault Blanking and Autoreset

After the fault condition is removed, the  $\overline{\text{FAULT}}$  output deasserts after a 20ms delay. Ensure that the MAX1823 has adequate input bypass capacitance to prevent glitches from triggering  $\overline{\text{FAULT}}$  outputs. Input glitches greater than  $0.2\text{V}/\mu\text{s}$  may cause erroneous  $\overline{\text{FAULT}}$  indications.

## Behavior During Current Limit and Fault Blanking

The MAX1823 limits switch current in three ways. When  $\text{ON}_n$  is deasserted (high for MAX1823/MAX1823A, low for MAX1823B/MAX1823H), the switch is off and leakage dominates the residual output current. When  $\text{ON}_n$  is asserted (low for MAX1823/MAX1823A, high for MAX1823B/MAX1823H), the switch supplies a continuous output current of at least 720mA. When the output current exceeds the 0.9A threshold, the MAX1823 limits the current depending on the output voltage. For  $V_{\text{OUT}}$  greater than 1V (current-limit mode), the MAX1823 regulates the output current to 0.9A. For

$V_{\text{OUT}}$  less than 1V (short-circuit mode), the MAX1823 pulses the switch, decreasing the current to  $0.35\text{A}_{\text{RMS}}$  (Table 1). Note that a thermal overload may result from either of these high-current conditions.

The MAX1823 switches may enter current limit in normal operation when powering up or driving heavy capacitive loads. To differentiate these conditions from short circuits or sustained overloads that may damage the device, the MAX1823 has an independent fault-blanking circuit in each switch. When a load transient causes the device to enter current limit, an internal counter starts to monitor the duration of the fault. For load faults exceeding 20ms fault-blanking time, the switch turns off, the  $\overline{\text{FAULT}}$  signal asserts low, and the device enters autoreset mode (see the *Autoreset Mode* section). Only current-limit and short-circuit faults are blanked. Thermal-overload faults and input voltage drops below the UVLO threshold immediately cause the switch to turn off and  $\overline{\text{FAULT}}$  to assert low.

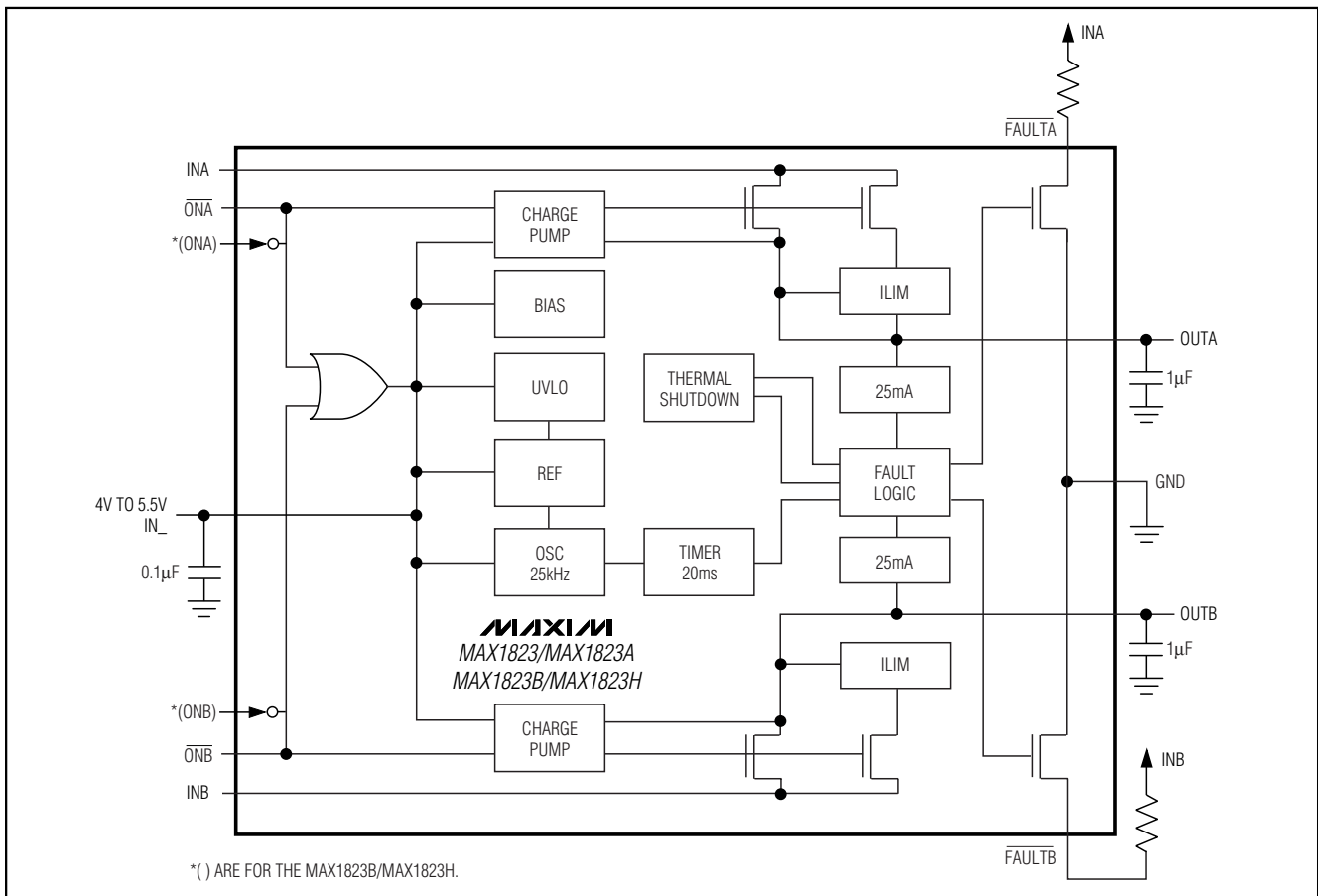

Figure 2. Functional Diagram

# Dual USB Switch with Fault Blanking and Autoreset

MAX1823/MAX1823A/MAX1823B/MAX1823H

**Table 1. MAX1823 Current Limiting and Fault Behavior**

| CONDITION                                  | MAX1823 BEHAVIOR   |
|--|--|
| Output short circuit ( $V_{OUT} < 1V$ )    | <ul style="list-style-type: none"> <li>An output short circuit ramps the current to <math>I_{SHORT}</math> in 2ms to 3ms, the switch shuts off, the blanking timer turns on, <math>\overline{FAULT}_-</math> stays high, and the output current pulses at <math>0.35A_{RMS}</math>.</li> <li>Removing the short circuit before the 15ms short-circuit blanking timeout period allows the next ramped current pulse to soft-start the output. The <math>\overline{FAULT}_-</math> flag stays high.</li> <li>A short circuit exceeding 15ms to 20ms forces <math>\overline{FAULT}_-</math> low at 20ms, enables autoreset mode, and sources 25mA at the output.</li> <li>An output voltage above 0.5V for 20ms resets the switch, turns on the output, and forces <math>\overline{FAULT}_-</math> high.</li> </ul> |
| Output overload current ( $V_{OUT} > 1V$ ) | <ul style="list-style-type: none"> <li>An output overload regulates the current at <math>I_{LIM}</math> (0.9A), and <math>\overline{FAULT}_-</math> stays high until the overload is removed, a thermal fault occurs, or the 20ms continuous current-limit timeout period is reached.</li> <li>An overcurrent condition still present at 20ms forces <math>\overline{FAULT}_-</math> low, enables autoreset, and sources 25mA at the output.</li> <li>An output voltage above 0.5V for 20ms resets the switch, turns on the output, and forces <math>\overline{FAULT}_-</math> high.</li> </ul>  |
| Thermal fault ( $T_J > +160^\circ C$ )     | <ul style="list-style-type: none"> <li>A junction temperature of <math>+160^\circ C</math> immediately forces <math>\overline{FAULT}_-</math> low (the blanking timer does not apply to thermal faults) and turns off the switch. The junction cooling <math>15^\circ C</math> removes the thermal fault condition, enables autoreset mode, and sources 25mA at the output. <math>\overline{FAULT}_-</math> remains low while a thermal fault condition is present.</li> <li>An output voltage above 0.5V for 20ms resets the switch, turns on the output, and forces <math>\overline{FAULT}_-</math> high.</li> </ul>   |

Fault blanking allows the MAX1823 to handle USB loads that may not be fully compliant with the USB specifications. USB loads with additional bypass capacitance and/or large startup currents can be successfully powered even while protecting the upstream power source. No fault is indicated if the switch is able to bring up the load within the 20ms blanking period.

## Applications Information

### Input Power Source

IN, INA, and INB provide the power for all control and charge-pump circuitry. All three IN\_ pins must be connected together externally. The input-voltage slew rate should be less than  $0.2V/\mu s$  to prevent erroneous  $\overline{FAULT}_-$  indications. This condition should not occur under normal USB applications.

### Input Capacitor

Connect a capacitor from IN\_ to ground to limit the input voltage drop during momentary output short-circuit conditions. A  $0.1\mu F$  ceramic capacitor is required for local decoupling; higher capacitor values further reduce the voltage drop at the input (see the Typical Application Circuit (Figure 1)). When driving inductive loads, a larger capacitance prevents voltage spikes from exceeding the MAX1823's absolute maximum ratings.

### Output Capacitor

Place a  $1\mu F$  or greater capacitor at each output for noise immunity. When starting up into very large capacitive loads, the switch pulses the output current at  $0.35A_{RMS}$  until the output voltage rises above 1V, then the capacitor continues to charge at the full 0.9A current limit. There is no limit to the output capacitor size, but to prevent a start-up fault assertion, the capacitor must charge up within the fault-blanking delay period. Typically, starting up into a  $330\mu F$  or smaller capacitor does not trigger a fault output. In addition to bulk capacitance, small-value ( $0.1\mu F$  or greater) ceramic capacitors improve the output's resilience to electrostatic discharge (ESD).

### Driving Inductive Loads

A wide variety of devices (mice, keyboards, cameras, and printers) can load the USB port. These devices commonly connect to the port with cables, which can add an inductive component to the load. This inductance causes the output voltage at the USB port to ring during a load step. The MAX1823 is capable of driving inductive loads, but avoids exceeding the device's absolute maximum ratings. Usually the load inductance is relatively small, and the MAX1823's input includes a substantial bulk capacitance from an upstream regulator as well as local bypass capacitors, limiting overshoot. If severe ringing occurs due to large load inductance, clamp the MAX1823's output below 6V and above -0.3V.

## Dual USB Switch with Fault Blanking and Autoreset

### Turn-On and Turn-Off Behavior

In the absence of faults, the MAX1823's internal switches turn on and off slowly under the control of the ON\_ inputs. Transition times for both edges are provided in the *Electrical Characteristics* table. The slow charge-pump switch drive minimizes load transients on the upstream power source. Under thermal fault and UVLO, the power device turns off rapidly (100ns) to protect the power device.

### Layout and Thermal Dissipation

To optimize the switch response time to output short-circuit conditions, keep all traces as short as possible to reduce the effect of undesirable parasitic inductance. Place input and output capacitors no more than 5mm from device leads. All IN\_ and OUT\_ pins must be connected with short traces to the power bus. Wide power-bus planes provide superior heat dissipation through the switch IN\_ and OUT\_ pins.

While the switches are on, power dissipation is small, and the package temperature change is minimal. Calculate the power dissipation for this condition as follows:

$$P = (I_{OUT\_})^2 R_{ON}$$

For the normal operating current ( $I_{OUT\_} = 0.5A$ ), and the maximum on-resistance of the switch ( $135m\Omega$ ), the power dissipation is:

$$P = (0.5A)^2 \times 0.135\Omega = 34mW \text{ per switch}$$

The worst-case power dissipation occurs when the switch is in current limit and the output is greater than 1V. In this case, the power dissipated in each switch is the voltage drop across the switch multiplied by the current limit:

$$P = (I_{LIM}) (V_{IN} - V_{OUT})$$

For a 5V input and 1V output, the maximum power dissipation per switch is:

$$P = (1.2A) (5V - 1V) = 4.8W$$

Since the package power dissipation is only 444mW, the MAX1823 die temperature exceeds the thermal-shutdown threshold, and the switch output shuts down until the junction temperature cools by 15°C. The duty cycle and period are strong functions of the ambient temperature and the PC board layout.

A short circuit at the output causes the power dissipated across the switch and the junction temperature to increase. If the fault condition persists, the thermal-overload-protection circuitry activates, and the output shuts down until the junction temperature decreases by 15°C (see the *Thermal Shutdown* section).

Since the output short-circuit current is 25mA (typ), and with  $V_{IN\_} = 5V$ , calculate the power dissipation for a short-circuited output as follows:

$$P = (0.025A)(5) = 0.125W$$

### Chip Information

TRANSISTOR COUNT: 3227

PROCESS: BiCMOS

# Dual USB Switch with Fault Blanking and Autoreset

## Package Information

(The package drawing(s) in this data sheet may not reflect the most current specifications. For the latest package outline information, go to [www.maxim-ic.com/packages](http://www.maxim-ic.com/packages).)

MAX1823/MAX1823A/MAX1823B/MAX1823H

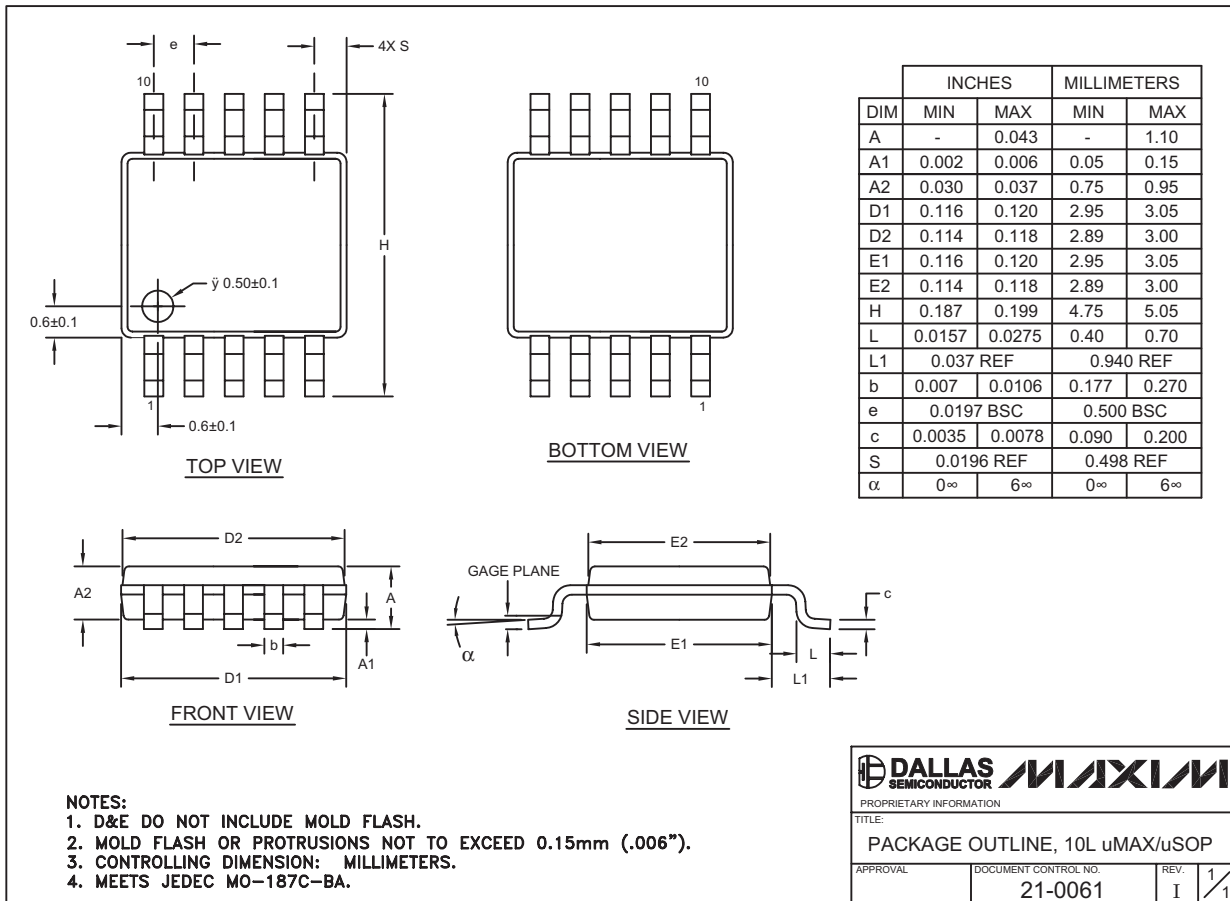

Maxim cannot assume responsibility for use of any circuitry other than circuitry entirely embodied in a Maxim product. No circuit patent licenses are implied. Maxim reserves the right to change the circuitry and specifications without notice at any time.

Maxim Integrated Products, 120 San Gabriel Drive, Sunnyvale, CA 94086 408-737-7600 13