

Click [here](#) to ask an associate for production status of specific part numbers.

Tiny, 0.4V to 5.5V Input, 300nA I_Q, nanoPower Boost Module with True Shutdown

MAXM17225

Product Highlights

- Extends Battery Life
 - 300nA Ultra-Low Quiescent Current
 - 0.5nA Shutdown Current
 - 95% Peak Efficiency
 - True Shutdown
 - Output Disconnects from Input
 - Zero Forward/Reverse Current from V_{IN}, V_{OUT}
- Easy to use—Addresses Popular Operation
 - V_{IN}: 5.5V Down to 0.4V
 - Minimum Startup Voltage of 0.88V
 - Single Resistor-Adjustable V_{OUT} from 1.8V to 5V
 - V_{OUT} Selection Resolution: In 100mV Steps
 - 1A Peak Inductor Current Limit
- Robust Performance Features Include
 - Internal Current Limit
 - Integrated Soft-Start
 - PFM Control Scheme for Higher Efficiency at Light Load Operation.
- Reduced Size and Increased Reliability
 - 2.1mm x 2.6mm, 10-Lead eMGA Package
 - Operating Temperature Range -40°C to +125°C

Key Applications

- Health Monitoring and Fitness Devices
- Ultra-Low-Power IoT Modules
- Bluetooth® LE Devices
- Wearables
- Portable Point-Of-Sale (POS) Terminals
- USB On-The-Go Adapter Modules, USB Charging
- Supercapacitor Backup for RTC/Alarm Buzzers
- Single or Dual Cell Alkaline Battery Products

Bluetooth is a registered trademark of Bluetooth SIG, Inc.

Simplified Application Diagram

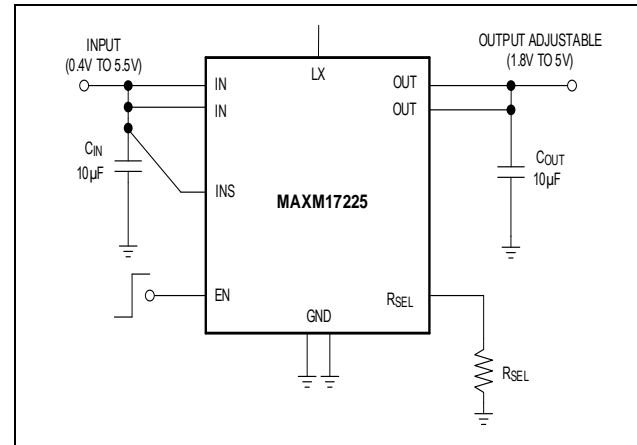

Pin Description

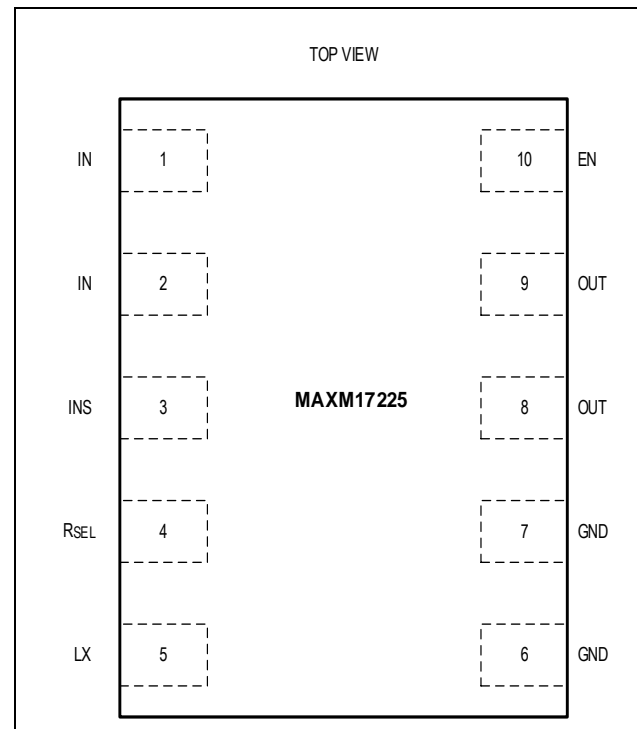

Ordering Information appears at end of data sheet.

Absolute Maximum Ratings

IN, INS, EN, OUT, R _{SEL} to GND	-0.3V to +6V	Operating Temperature Range.....	-40°C to +125°C
LX to GND	-0.3V to V _{OUT} +0.3V	Maximum Junction Temperature	+150°C
Continuous Power Dissipation (T _A = +70°C).....		Storage Temperature Range.....	-65°C to +150°C
eMGA (derate 9.72 mW/°C above 70°C).....	777.91mW	Lead Temperature (soldering, 10 seconds)	+300°C
		Soldering Temperature (reflow).....	+260°C

Note 1: LX pin has internal clamps to GND and OUT. These diodes may be forward biased during switching transitions.

Stresses beyond those listed under "Absolute Maximum Ratings" may cause permanent damage to the device. These are stress ratings only, and functional operation of the device at these or any other conditions beyond those indicated in the operational sections of the specifications is not implied. Exposure to absolute maximum rating conditions for extended periods may affect device reliability.

Package Information

10 eMGA

Package Code	M102A2+3
Outline Number	21-100245*
Land Pattern Number	90-100084*
Thermal Resistance, Four Layer Board:	
Junction to Ambient (θ _{JA})	102.84 °C/W
Junction to Case Thermal Resistance (θ _{JC})	15.04 °C/W

For the latest package outline information and land patterns (footprints), go to www.maximintegrated.com/packages. Note that a "+", "#", or "-" in the package code indicates RoHS status only. Package drawings may show a different suffix character, but the drawing pertains to the package regardless of RoHS status.

Package thermal resistances were obtained using the method described in JEDEC specification JESD51-7, using a four-layer board. For detailed information on package thermal considerations, refer to www.maximintegrated.com/thermal-tutorial.

Electrical Characteristics

(V_{IN} = V_{INS} = V_{EN} = 1.5V, V_{OUT} = 3.0V, T_A = -40°C to +125°C, C_{IN} = C_{OUT} = 1x10µF, unless otherwise specified, see [Note 2](#).)

PARAMETER	SYMBOL	CONDITIONS	MIN	TYP	MAX	UNITS
Minimum Input Voltage	V _{IN_MIN}	Runs from output after startup, I _{OUT} = 1mA		400		mV
Input Voltage Range	V _{IN}	Guaranteed by LX max On-time	0.95		5.5	V
Minimum Startup Input Voltage	V _{IN_STARTUP}	R _L ≥ 3kΩ, Typical Operating Circuit, T _A = 25°C		0.88	0.95	V
Output Voltage Range	V _{OUT}	See R_{SEL} Selection Table . For V _{IN} < V _{OUT} target. Note 3	1.8		5	V
Output Accuracy, LPM	ACC _{LPM}	V _{OUT} falling when LX switching frequency is > 1MHz. Note 4	-1.5		1.5	%
Output Accuracy, Ultra-Low-Power Mode	ACC _{ULPM}	V _{OUT} falling when LX switching frequency is > 1kHz. Note 5	1	2.5	4	%
Output Current	I _{OUT}	V _{IN} = 1.8V, V _{OUT} = 3.3V See I _{OUT} vs. V _{IN} curves in TOC section		200		mA
Efficiency	η	V _{IN} = 1.8V, V _{OUT} = 3.3V, I _{OUT} = 100µA		95		%
		V _{IN} = 1.8V, V _{OUT} = 3.3V, I _{OUT} = 50mA		93		
Quiescent Supply Current into OUT	I _{Q_OUT}	V _{EN} = V _{IN} , Not switching, V _{OUT} = 104% of 1.8V T _A = 25°C		300	600	nA

Tiny, 0.4V to 5.5V Input, 300nA I_Q, nanoPower Boost Module with True Shutdown

[MAXM17225](#)

(V_{IN} = V_{INS} = V_{EN} = 1.5V, V_{OUT} = 3.0V, T_A = -40°C to +125°C, C_{IN} = C_{OUT} = 1x10μF, unless otherwise specified, see [Note 2](#).)

PARAMETER	SYMBOL	CONDITIONS		MIN	TYP	MAX	UNITS
		V _{EN} = V _{IN} , Not switching, V _{OUT} = 104% of 1.8V	T _A = -40°C to 85°C		470	900	
		V _{EN} = V _{IN} , Not switching, V _{OUT} = 104% of 1.8V	T _A = -40°C to 125°C		1000	2000	
Quiescent Supply Current into INS	I _{Q_INS}	V _{OUT} = 104% of 1.8V	T _A = 25°C		0.1		nA
Total Quiescent Supply Current into IN, INS, EN	I _{Q_IN_TOTAL}	Not switching, V _{OUT} = 104% of 1.8V. Total current includes IN, INS, and EN. T _A = 25°C			0.5	100	nA
Shutdown Current into INS	I _{SD_INS}	V _{OUT} = V _{EN} = 0V, T _A = +25°C, R _L = 3kΩ			0.1		nA
Total Shutdown Current into IN, INS	I _{SD_TOTAL}	V _{EN} = 0V, V _{IN} = V _{INS} = 1.5V, includes IN leakage, T _A = +25°C, R _L = 3kΩ			0.5	100	nA
Inductor Peak Current Limit	I _{PEAK}	Note 6		0.8	1	1.2	A
LX Maximum Duty Cycle	DC	Note 7		70	75		%
LX Maximum On-Time	t _{ON}	Note 7	V _{OUT} = 1.8 V	280	365	450	ns
			V _{OUT} = 3 V	270	300	330	
LX Minimum Off-Time	t _{OFF}	Note 7	V _{OUT} = 1.8V	90	120	150	ns
			V _{OUT} = 3 V	80	100	120	
N-Channel On-Resistance	LS_R _{DS(ON)}	V _{OUT} = 3.3V			31	70	mΩ
P-Channel On-Resistance	HS_R _{DS(ON)}	V _{OUT} = 3.3V			75	150	mΩ
Synchronous rectifier Zero Crossing as a percent of Peak Current Limit	I _{ZX}	V _{OUT} = 3.3V, Note 8		2.5	5	7.5	%
Enable Voltage Threshold	V _{IL}	When LX switching stops, EN falling, T _A = -40°C to +85°C		250	500		mV
		When LX switching stops, EN falling, T _A = -40°C to +125°C		150			
	V _{IH}	EN rising, T _A = -40°C to +85°C			600	850	
		EN rising, T _A = -40°C to +125°C				900	
Enable Input Leakage	I _{EN_LK}	V _{EN} = 5.5V, T _A = +25°C			0.1		nA
Required Select Resistor Accuracy	R _{SEL_ACC}	Use the nearest ±1% resistor from R_{SEL} Selection Table .		-1		1	%
Select Resistor Detection Time	t _{RSEL}	V _{OUT} = 1.8V, C _{RSEL} < 2pF, Note 9		360	600	1320	μs

Note 2: Limits are 100% production tested at T_A = +25°C. Limits over the operating temperature range and supply voltage range are guaranteed by design and correlation using Statistical Quality Control (SQC) methods.

Note 3: Guaranteed by the required select resistor accuracy parameter.

Note 4: Output accuracy, low-power mode is the regulation accuracy window expected when I_{OUT} > I_{OUT_TRANSITION}. See [PFM Control Scheme](#) and V_{OUT_ERROR} vs I_{LOAD} TOC for more details. This accuracy does not include load, line, or ripple.

Note 5: Output accuracy, ultra-low-power mode is the regulation accuracy window expected when I_{OUT} < I_{OUT_TRANSITION}. See [PFM Control Scheme](#) and V_{OUT_ERROR} vs I_{LOAD} TOC for more details. This accuracy does not include load, line, ripple.

Note 6: The maximum current limit parameter accounts for 5% of overcurrent due to propagation delays. This is a static measurement.

Note 7: Guaranteed by measuring LX frequency and duty cycle.

Note 8: This is a static measurement.

Note 9: This is the time required to determine R_{SEL} value. This time adds to the startup time. See [Output Voltage Selection](#).

Typical Application Circuit

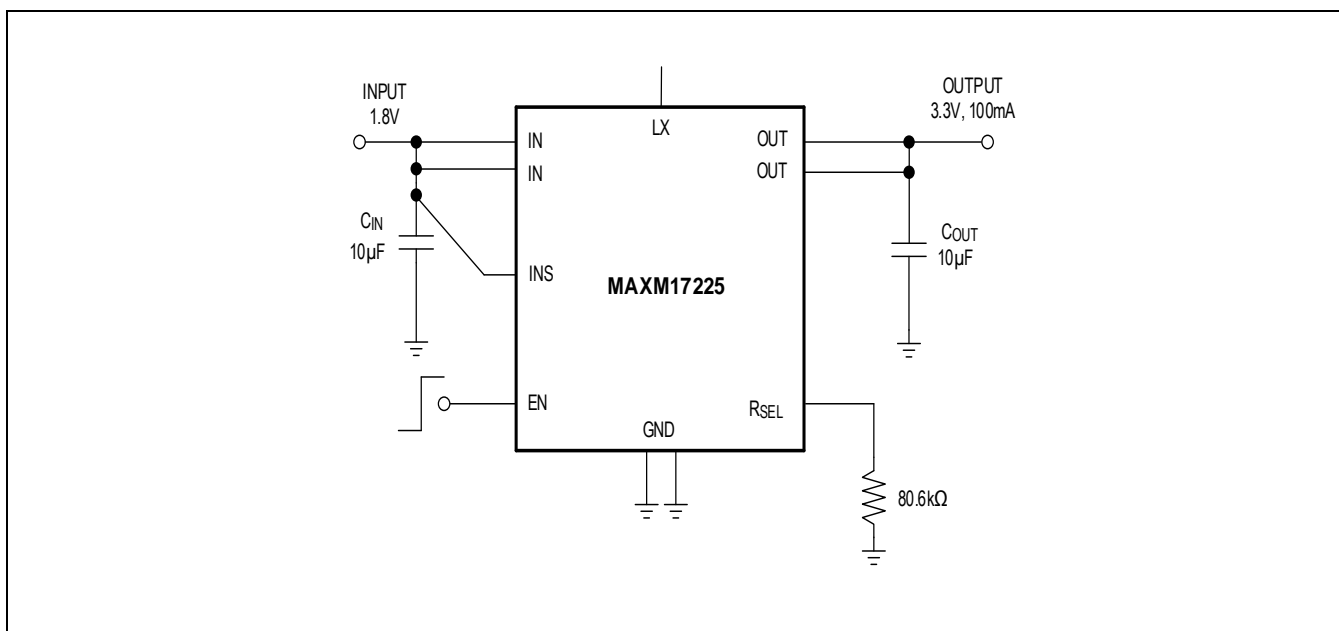

Typical Operating Characteristics

(MAXM17225AMB+T, V_{IN} = V_{INS} = 1.5V, V_{OUT} = 3.3V, L = 1.0μH (integrated), C_{IN} = 1x10μF, C_{OUT} = 1x10μF, T_A = 25°C unless otherwise specified.)

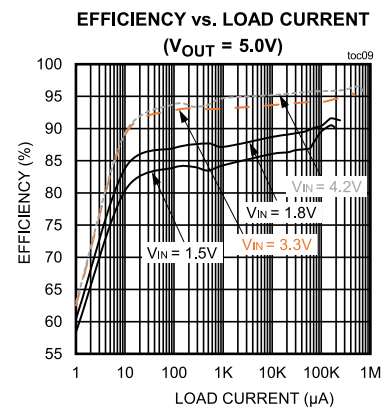
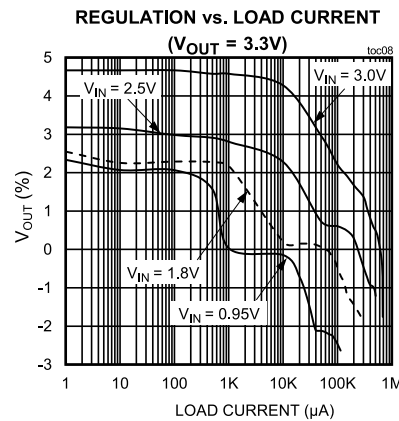
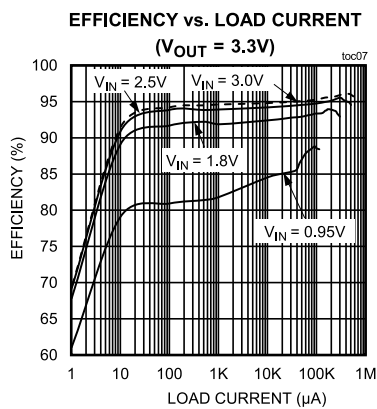
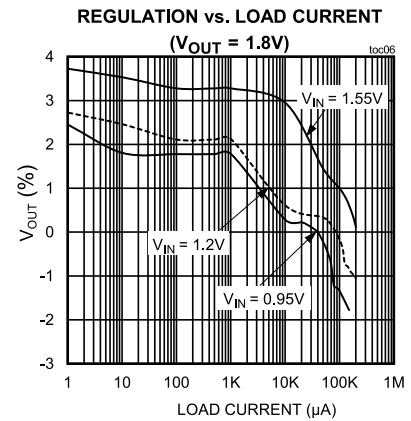
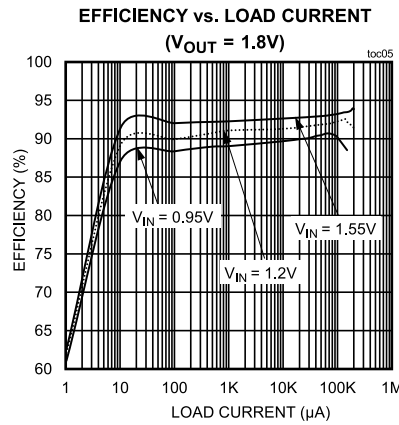
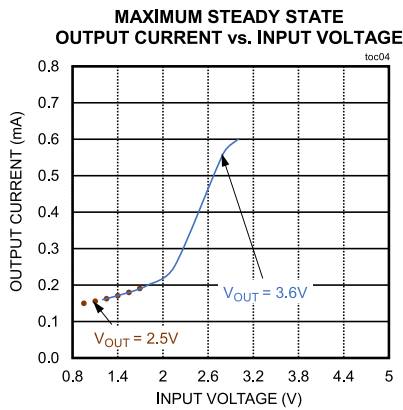
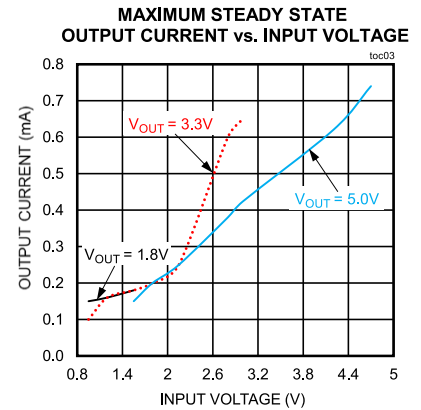
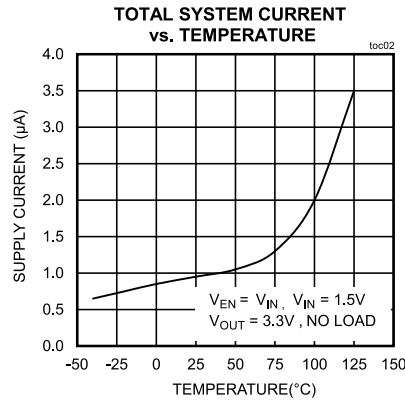
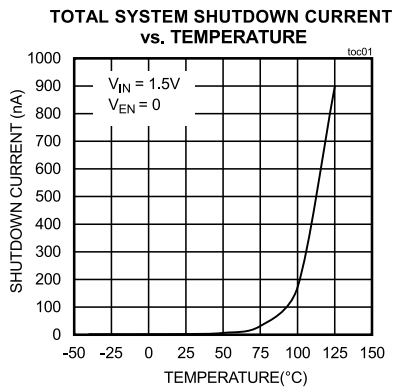

Tiny, 0.4V to 5.5V Input, 300nA I_Q, nanoPower Boost Module with True Shutdown

MAXM17225

(MAXM17225AMB+T, V_{IN} = V_{INS} = 1.5V, V_{OUT} = 3.3V, L = 1.0μH (integrated), C_{IN} = 1x10μF, C_{OUT} = 1x10μF, T_A = 25°C unless otherwise specified.)

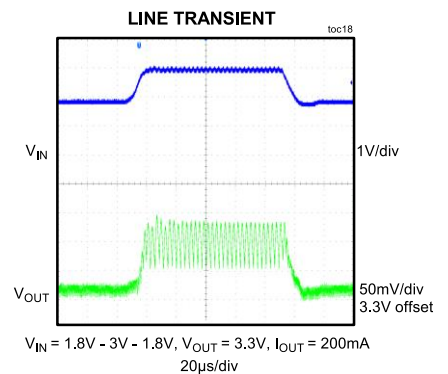
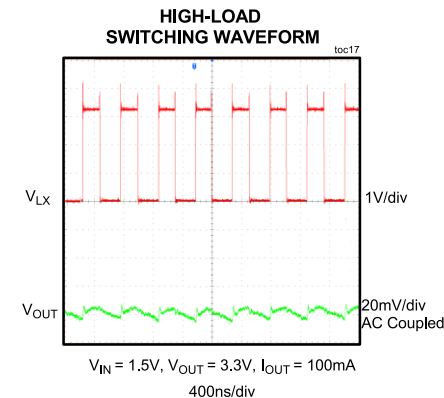
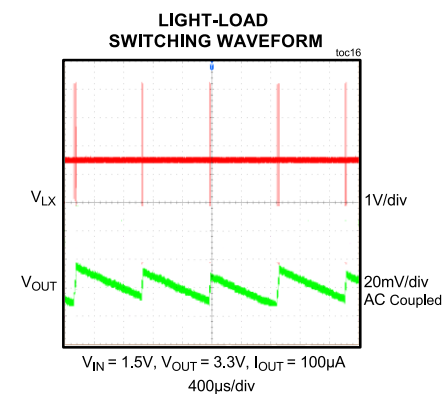
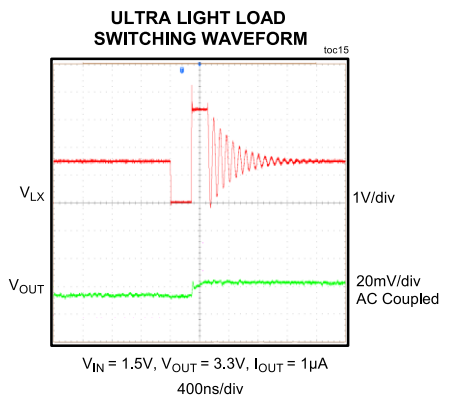
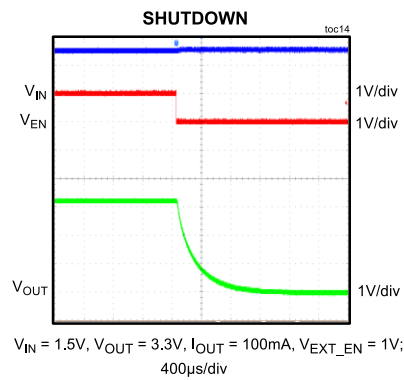
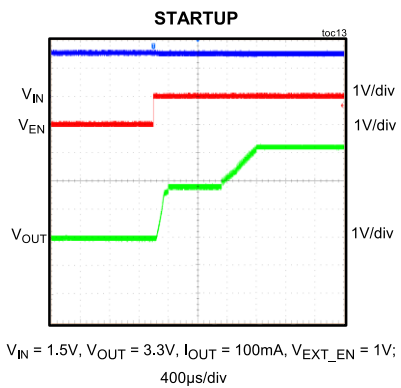
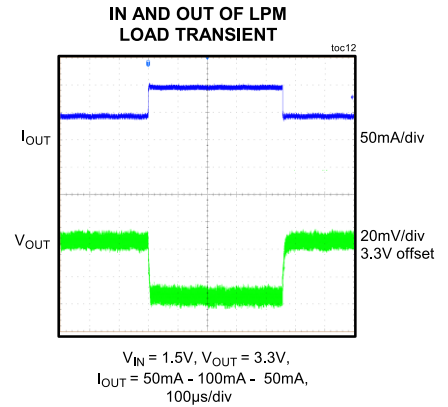
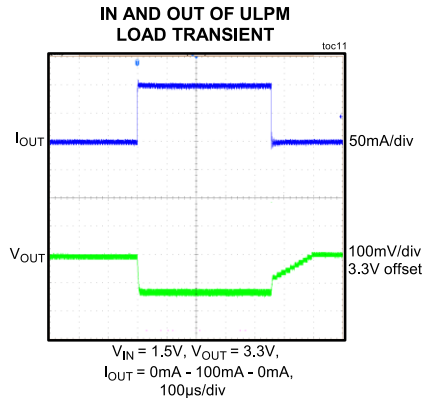
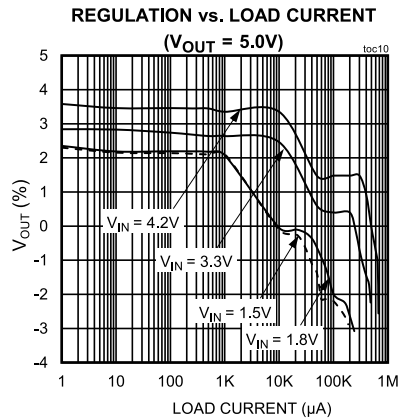

Pin Configurations

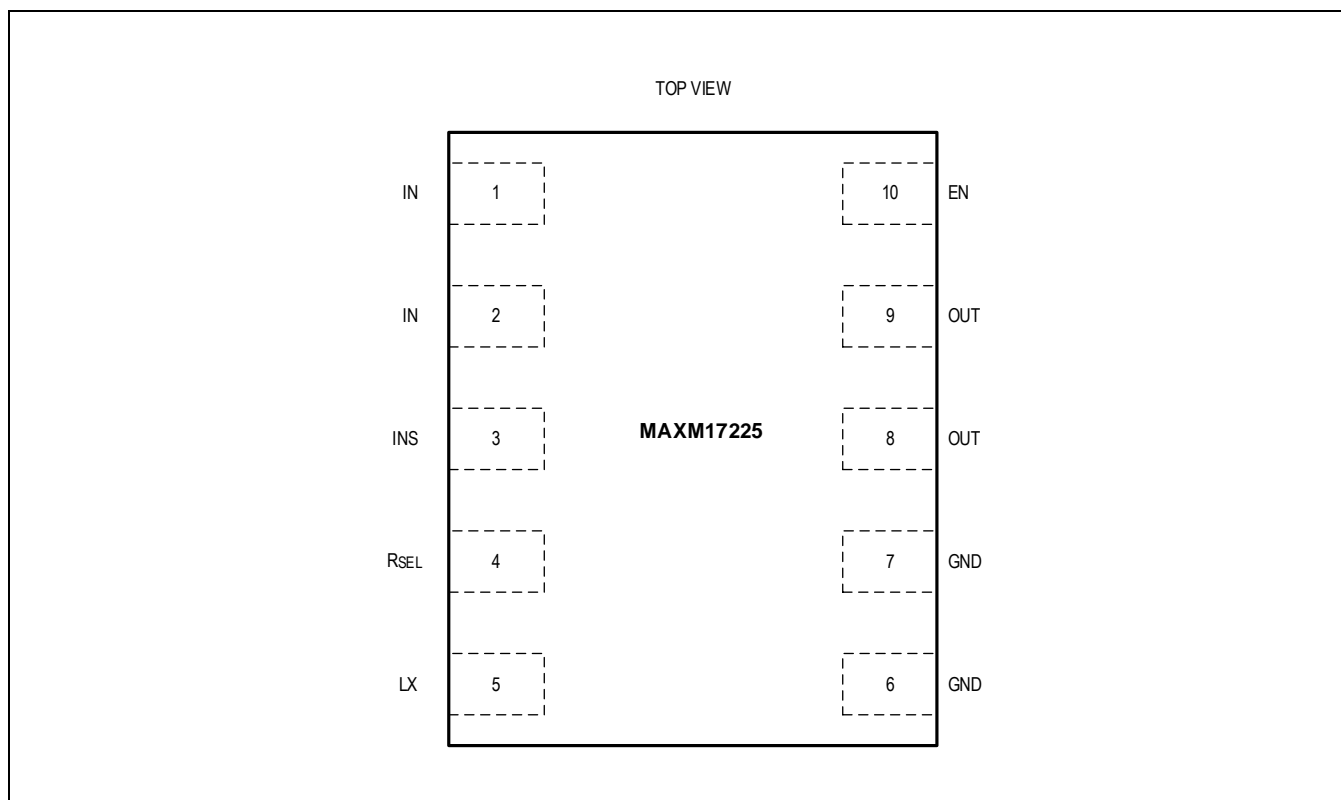

Pin Descriptions

PIN	NAME	FUNCTION
1, 2	IN	Module Supply Input Pins. Connect a 10µF ceramic capacitor from IN to GND.
3	INS	Input Sense Pin. Connect this pin directly to the Input Capacitor node.
4	R _{SEL}	Output Voltage Select Input. Connect a resistor from R _{SEL} to GND to program the output voltage based on the MAXM17225 R_{SEL} Selection Table .
5	LX	Switching Node Pin. Must be left floating; used by factory for testing only.
6, 7	GND	Ground Pins.
8, 9	OUT	Output Voltage Pins. Connect a 10µF ceramic capacitor from OUT to GND.
10	EN	Enable Input. Force this pin high to enable the boost module. Force this pin low to disable the part and enter shutdown.

Simplified Block Diagram

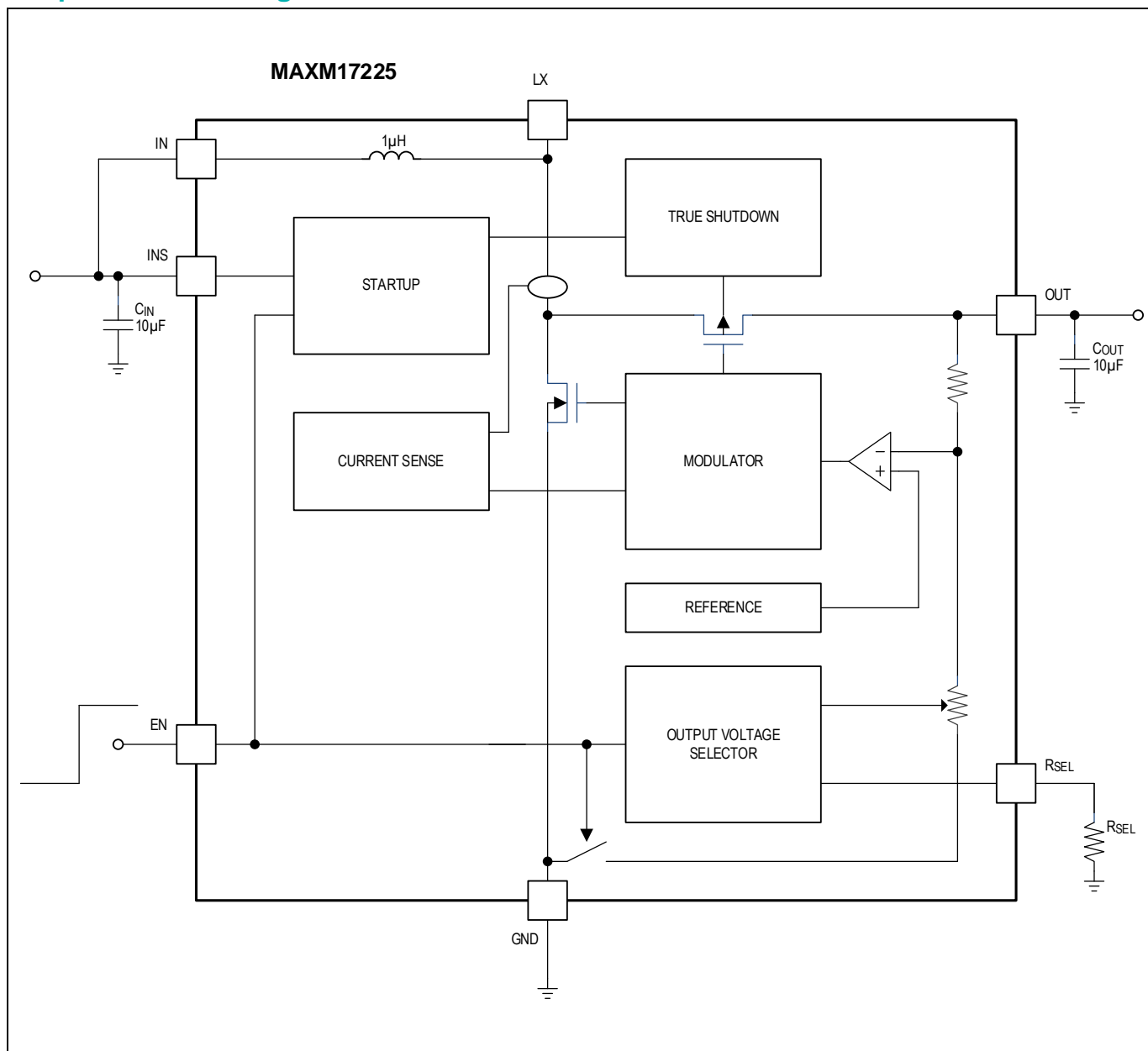

Detailed Description

The MAXM17225 is a nanoPower, ultra-low-I_Q (300nA) boost module offered in a tiny eMGA package. The IC is guaranteed to startup with voltages as low as 0.88V and post startup, the input voltage V_{IN} can go down to 0.4V making it ideal for battery-operated devices that undergo voltage discharge over time. Its ultra-low quiescent current of 300nA prolongs battery life and extends product lifetime as well. The IC accepts input voltage from 0.4V to 5.5V and boosts it up to programmable output voltages from 1.8V to 5V. The output voltage is set using a single external resistor (R_{SEL}). The product has a maximum efficiency of 95%. The module is well suited for a host of applications like battery-operated devices, portable electronics where step-up conversion is needed in space constrained enclosures while demanding high efficiency. A true shutdown disconnects the input from the output, conserving battery life. The IC has an integrated 1μH inductor chosen for optimized operation, stability, and efficiency. Guaranteed Boost V_{OUT} regulation for 250mV separation between input and output voltages while driving heavy loads. A single external selectable resistor (R_{SEL}) for V_{OUT} setting reduces quiescent current consumption in comparison with a conventional resistor feedback divider string. The MAXM17225 has a fixed maximum 300ns switch turn-on time and peak inductor current limit of 1A. The IC auto-transitions between the ULPM, LPM, and HP operating modes based on load current, enabling better system transient response and efficiency. All these powerful features are packed in a tiny 10-lead eMGA package offering the end designer an efficient tool to design products.

Integrated Inductor

A 1μH integrated inductor is used in MAXM17225 boost module. The chosen inductor (Murata part# DFE201610E-1R0M = P2), offers optimized stability across the product operation range.

True Shutdown

The MAXM17225's true shutdown feature has the following advantages:

- Eliminates the body diode conduction of high-side P-channel MOSFET synchronous rectifier.
- Draws zero current in forward/reverse direction from IN/OUT.
- V_{OUT} can be pulled high without bootstrapping into V_{IN} source.

Output Voltage Selection

The MAXM17225 has a unique single-resistor output selection method known as R_{SEL}. At startup, the MAXM17225 uses up to 200μA only during the select resistor detection time, typically for 600μs, to read the R_{SEL} value. R_{SEL} has many benefits, which include lower cost and smaller size, and only one resistor is needed versus the two-resistor string in conventional resistor divider feedback connections. Another benefit is R_{SEL} allows customers to stock just one part in their inventory system and use it in multiple projects with different output voltages just by changing a single standard 1% resistor. Lastly, R_{SEL} eliminates wasting current continuously through feedback resistors for ultralow-power battery-operated products. Select the R_{SEL} resistor value for the desired output voltage as shown in the [R_{SEL} Selection Table](#).

R_{SEL} Selection Table

The MAXM17225 includes an R_{SEL} pin to configure the output voltage. Resistors with a tolerance of 1% (or better) should be chosen. See Output Voltage vs. corresponding R_{SEL} resistor table below.

V _{OUT} (V)	NOMINAL RESISTANCE R _{SEL} (kΩ) - 1%
1.8	OPEN
1.9	909
2.0	768
2.1	634
2.2	536
2.3	453
2.4	383
2.5	324

V _{OUT} (V)	NOMINAL RESISTANCE R _{SEL} (kΩ) - 1%
2.6	267
2.7	226
2.8	191
2.9	162
3.0	133
3.1	113
3.2	95.3
3.3	80.6
3.4	66.5
3.5	56.2
3.6	47.5
3.7	40.2
3.8	34
3.9	28
4.0	23.7
4.1	20
4.2	16.9
4.3	14
4.4	11.8
4.5	10
4.6	8.45
4.7	7.15
4.8	5.9
4.9	4.99
5.0	SHORT TO GND

PFM Control Scheme

The MAXM17225 utilizes a fixed on-time, current-limited, pulse-frequency-modulation (PFM) control scheme that allows ultra-low quiescent current and high efficiency over a wide output current range. The inductor current is limited by the 1A peak current limit or by the 300ns switch maximum on-time. During each switch ON cycle, either the maximum on-time or the maximum current limit is reached before the off-time of the cycle begins. The MAXM17225 PFM control scheme allows for both continuous-conduction mode (CCM) or discontinuous-conduction mode (DCM). When the error comparator senses that the output voltage has fallen below the regulation threshold, another cycle begins. See the [MAXM17225 Simplified Block Diagram](#).

To increase efficiency, MAXM17225 incorporates a unique PFM control scheme wherein the converter auto-transitions into different operating modes based on load current to be delivered. Ultra-low-power mode (ULPM) for very light load currents of order of a few μAs. In ULPM, the output voltage, by design, is over-regulated to 2.5% higher than target V_{OUT} so that it can more easily weather a future large load transient. In this mode, the converter switches at a rate of 17.5μs. As load current demand rises to a 0.1-10's of mAs (mode-transition is again V_{IN} and V_{OUT} separation, load current dependent), the converter switches into LPM (low-power mode) wherein the converter always switches faster than 17.5μs. Finally for high currents of the order of a few 10's to 100's of mA the converter operates in high-power mode (continuous-conduction mode).

Figure 1 and Figure 2 show typical waveforms while in each mode. ULPM is used when the system is in standby or an ultra-low-power state. LPM and HPM are useful for sensitive sensor measurements or during wireless communications for medium output currents and large output currents, respectively. The user can calculate the value of the load current where ULPM transitions to LPM using the equation below. For example, for V_{IN} = 1.5V, V_{OUT} = 3V, and L = 1μH, the ULPM to LPM transition current happens at approximately 3.28mA. The MAXM17225 enters HPM when the inductor current transitions from DCM to CCM.

$$I_{OUT_TRANSITION} = (300ns \times 300ns / 2L) \times [V_{IN} / \{(V_{OUT}/V_{IN})-1\} \times (\eta/17.5\mu s)]$$

$$= (300ns \times 300ns / 2 \times 1\mu H) \times [1.5V / \{(3V/1.5V)-1\} \times (0.85/17.5\mu s)] = 3.28mA$$

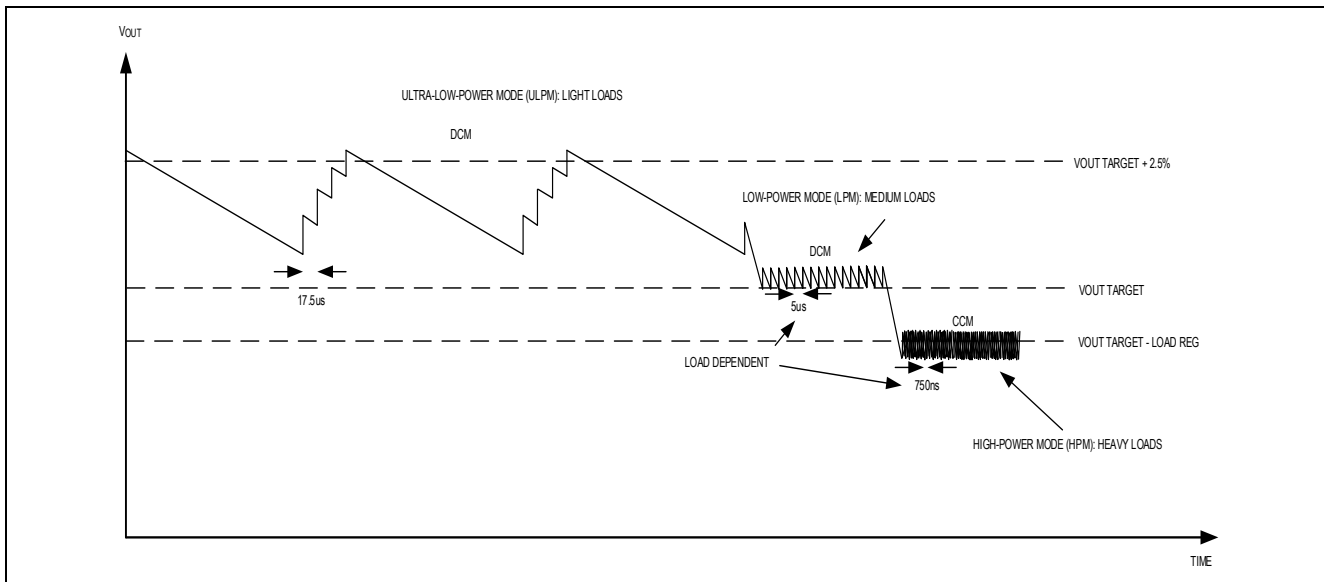

Figure 1. ULPM, LPM, and HPM waveforms

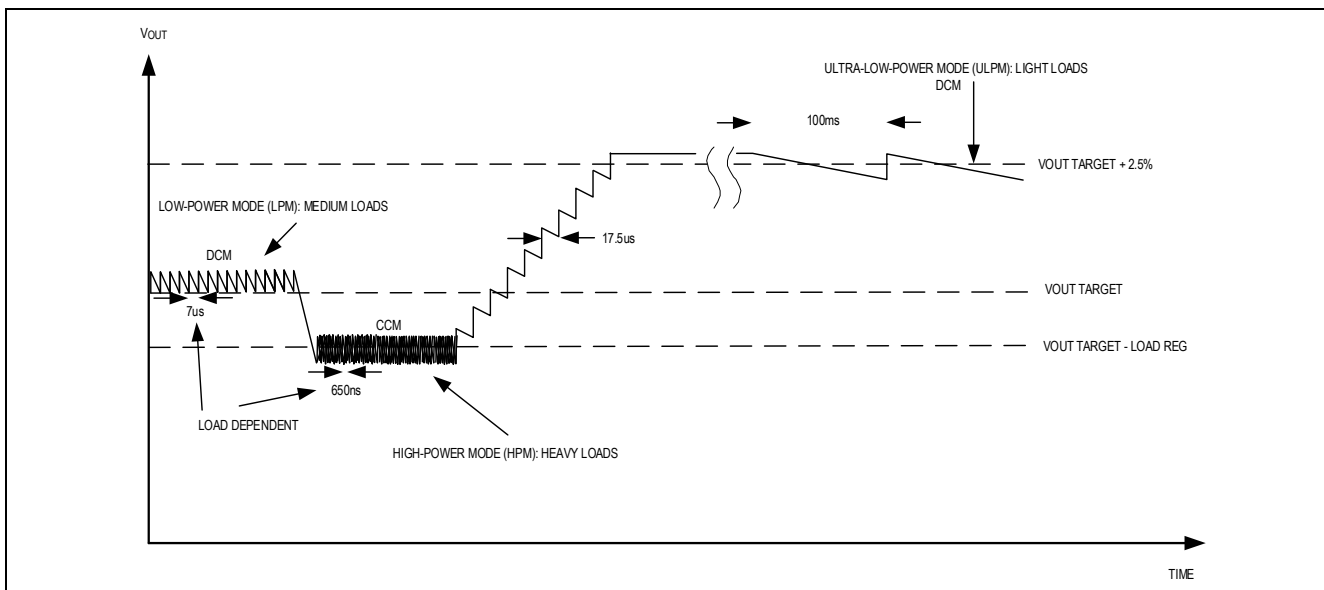

Figure 2. ULPM, LPM, and HPM waveforms

V_{IN} > V_{OUT}, V_{IN} ≈ V_{OUT} Operation

If the input voltage (V_{IN}) is greater than the output voltage (V_{OUT}) by a diode drop (V_{DIODE} varies from ~0.2V at light load to ~0.7V at heavy load), then the output voltage is clamped to a diode drop below the input voltage (i.e., V_{OUT} = V_{IN} - V_{DIODE}). When the input voltage is closer to the output voltage target (i.e., V_{OUT TARGET} + V_{DIODE} > V_{IN} > V_{OUT TARGET}), the MAXM17225 operates like a buck converter with higher output voltage ripple.

In boost mode, if V_{IN} and V_{OUT} separation is 250mV or lesser, it is suggested to have a higher output capacitance than the recommended 1x10μF to reduce the output voltage ripple. The exact capacitance value depends on the application need and acceptable voltage ripple in the application. In most cases, 2x10μF will be more than sufficient.

Soft-Start

The MAXM17225 initiates a controlled soft-start in the event that a supply voltage is reapplied at a high dV/dt rate, a typical example is during the installation of a fresh battery. While in regulation, if V_{IN} steps abruptly above V_{OUT} for more than 1V (typ), the device resets. The output voltage droop, in this case, will be a function of the load current, output capacitance, and time required for soft-start to complete, which is 1.5ms (typ). The IC has 3 slew rate routines, which the internal advanced algorithm auto-chooses based on the converter state, those are linear ramp of V_{OUT} with time called linear slew up, the second one is open loop low voltage oscillation (this is uncontrolled), and the last one is the linear slewing where the synchronous rectifier acts as a current source controlling the ramp up.

Applications Information

Input Capacitor

The input capacitor (C_{IN}) reduces the peak current drawn from battery or input power source and reduces the switching noise in the module. The impedance of C_{IN} at the switching frequency should be very low. Ceramic capacitors are recommended for their small size and low ESR. For most applications, use a 10μF ceramic capacitor with X7R temperature characteristics, making it suitable for 125°C module operation. While choosing capacitor dielectric other than X7R, keep a check on % capacitance change across temperature. It is also recommended to check the DC bias curves to determine the minimum effective capacitance at the application voltage for the rated capacitance value chosen. X5R capacitor can also be used if the worst-case capacitor surface temperature in the product at worst-case operating temperature is well below 85°C.

Output Capacitor

The output capacitor (C_{OUT}) is required to keep the output voltage ripple small and to ensure loop stability. C_{OUT} must have low impedance at the switching frequency. Ceramic capacitors are recommended due to their small size and low ESR. Make sure the capacitor does not degrade its capacitance significantly over temperature and DC bias. Capacitors with X7R temperature characteristics typically perform well. X5R can also be chosen if the worst-case capacitor surface temperature is well below 85°C. For most applications, it is recommended to use a 10μF X7R ceramic output capacitor.

Enable Input

The MAXM17225 has a separate enable pin to enable/disable the device. The typical falling voltage threshold for enable is 0.5V, and likewise, the rising voltage threshold at device startup is 0.6V at room temp. When EN and IN are tied together, the enable threshold of the device can interfere with product operation as V_{IN} drops below 550mV, preventing the device from reaching its minimum specification (i.e., V_{IN_MIN}) of 400mV. In such cases, it is recommended to use an external enable, independent of V_{IN} and external V_{EN} level must be higher than device V_{EN} threshold to ensure the device operates as low as 400mV V_{IN}, post startup.

R_{SEL} Considerations

The single R_{SEL} external resistor used for V_{OUT} selection needs some considerations. The trace parasitic capacitance from R_{SEL} pin to external resistor should be less than 2pF to facilitate an accurate resistance read at device startup. The typical resistor read time is 600μs at device startup, and this happens only once. A minimum of 1.8V at V_{OUT} is needed for internal ADC to accurately read the resistance value and configure the V_{OUT}.

PCB Layout Considerations

Use large PCB copper areas for high current paths, including V_{IN}, GND, and V_{OUT}. The connection from the bottom of the output capacitor and the ground pin of the device must be extremely short, as should be that of the input capacitor. Keep the main power path from IN, OUT and GND, as tight and as short as possible. Connect the INS (Input Sense) pin directly to the input capacitor with a short trace. Bring out test points for IN, OUT for easy probing and debugging. Refer to the MAXM17225 EV kit datasheet for suggestive PCB layout.

Ordering Information

PART NUMBER	TEMPERATURE RANGE	PIN PACKAGE	FEATURES
MAXM17225AMB+T	-40°C to +125°C	10-lead eMGA package (2.1mm x 2.6mm, 0.5mm pitch)	1.8V to 5V resistor-selectable output voltage using R _{SEL} pin

+ Denotes a lead (Pb)-free/RoHS-compliant package.

T = Tape and reel.

Revision History

REVISION NUMBER	REVISION DATE	DESCRIPTION	PAGES CHANGED
0	7/21	Market Intro Release	—
1	8/21	Updated <i>Electrical Characteristics</i> Table.	2, 3

For pricing, delivery, and ordering information, please visit Maxim Integrated's online storefront at <https://www.maximintegrated.com/en/storefront/storefront.html>.

Maxim Integrated cannot assume responsibility for use of any circuitry other than circuitry entirely embodied in a Maxim Integrated product. No circuit patent licenses are implied. Maxim Integrated reserves the right to change the circuitry and specifications without notice at any time. The parametric values (min and max limits) shown in the Electrical Characteristics table are guaranteed. Other parametric values quoted in this data sheet are provided for guidance.