

This IC, developed by using high-withstand voltage CMOS process technology, is a voltage tracker with a reverse current protection function, which has high-withstand voltage and low current consumption.

Since the maximum operating voltage is as high as 36 V and the current consumption is as low as 30 μA typ., it contributes to the reduction of standby current.

This IC operates stably due to the internal phase compensation circuit so that users are able to use low ESR ceramic capacitor as the output capacitor.

This IC includes an overcurrent protection circuit that prevents the load current from exceeding the current capacity of the output transistor and a thermal shutdown circuit that prevents damage because of overheating.

Due to the built-in reverse current protection function, the reverse current flowing from the VOUT pin to the VIN pin can be controlled as the small value $-5 \mu\text{A}$ min. Therefore, IC protection diode is not needed.

ABLIC Inc. offers a "thermal simulation service" which supports the thermal design in conditions when our power management ICs are in use by customers. Our thermal simulation service will contribute to reducing the risk in the thermal design at customers' development stage.

ABLIC Inc. also offers FIT rate calculated based on actual customer usage conditions in order to support customer functional safety design.

Contact our sales representatives for details.

Caution This product can be used in vehicle equipment and in-vehicle equipment. Before using the product for these purposes, it is imperative to contact our sales representatives.

■ Features

- Input voltage: 4.0 V to 36.0 V
- Offset voltage: ± 5 mV ($0.1 \text{ mA} \leq I_{\text{OUT}} \leq 50 \text{ mA}$)
- Dropout voltage: 160 mV typ. ($V_{\text{ADJ/EN}} = 4.0 \text{ V}$, $I_{\text{OUT}} = 10 \text{ mA}$)
- Current consumption:
 - During operation: 30 μA typ.
 - During power-off: 4.0 μA typ.
- Output current: Possible to output 50 mA ($V_{\text{IN}} = V_{\text{ADJ/EN}} + 2.0 \text{ V}$)*1
- Input capacitor: A ceramic capacitor can be used. (1.0 μF or more)
- Output capacitor: A ceramic capacitor can be used. (1.0 μF to 1000 μF)
- Built-in overcurrent protection circuit: Limits overcurrent of output transistor.
- Built-in thermal shutdown circuit: Detection temperature 175°C typ.
- Reverse current protection function: $I_{\text{REV}} = -5 \mu\text{A}$ min. ($V_{\text{IN}} = 0 \text{ V}$, $V_{\text{ADJ/EN}} = 5.0 \text{ V}$, $V_{\text{OUT}} = 16.0 \text{ V}$)
- Operation temperature range: $T_{\text{a}} = -40^\circ\text{C}$ to $+125^\circ\text{C}$
- Lead-free (Sn 100%), halogen-free
- Withstand 45 V load dump
- AEC-Q100 qualified*2

*1. Please make sure that the loss of the IC will not exceed the power dissipation when the output current is large.

*2. Contact our sales representatives for details.

■ Applications

- Power supply for automotive off-board sensors
- For automotive use (engine, transmission, suspension, ABS, related-devices for EV / HEV / PHEV, etc.)

■ Packages

- SOT-23-5
- HSNT-6(2025)

■ Block Diagram

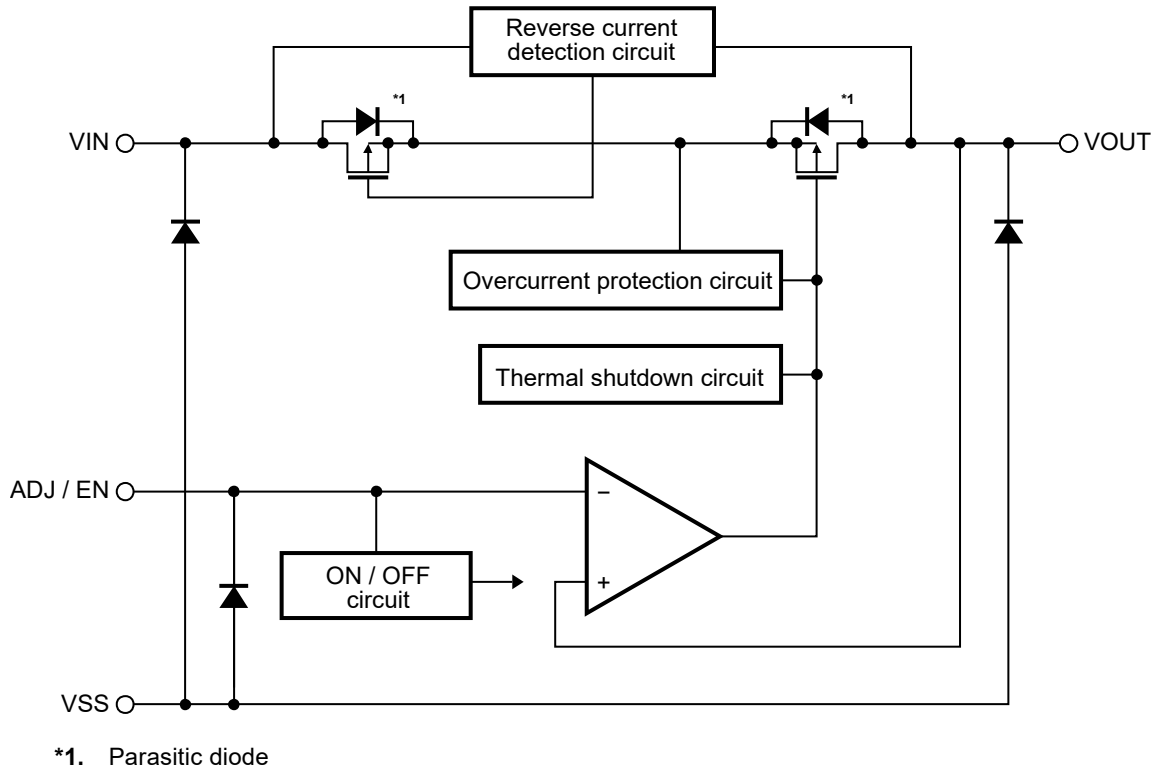

Figure 1

■ AEC-Q100 Qualified

This IC supports AEC-Q100 for operation temperature grade 1.
 Contact our sales representatives for details of AEC-Q100 reliability specification.

■ Product Name Structure

1. Product name

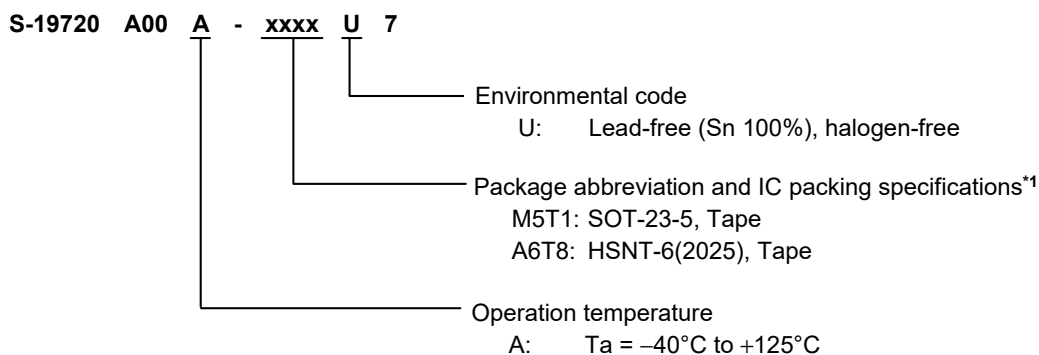

*1. Refer to the tape drawing.

2. Packages

Table 1 Package Drawing Codes

Package Name	Dimension	Tape	Reel	Land
SOT-23-5	MP005-A-P-SD	MP005-A-C-SD	MP005-A-R-SD	–
HSNT-6(2025)	PJ006-B-P-SD	PJ006-B-C-SD	PJ006-B-R-SD	PJ006-B-LM-SD

3. Product name list

Table 2

Product Name	Package
S-19720A00A-M5T1U7	SOT-23-5
S-19720A00A-A6T8U7	HSNT-6(2025)

■ Pin Configurations

1. SOT-23-5

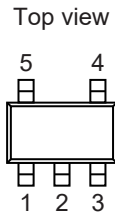

Figure 2

Pin No.	Symbol	Description	
		ADJ	Output voltage adjustment pin
1	ADJ / EN	EN	Enable pin
2	VSS*1	GND pin	
3	VIN	Input voltage pin	
4	VOUT	Output voltage pin	
5	VSS*1	GND pin	

*1. Be sure to short the VSS pins.

2. HSNT-6(2025)

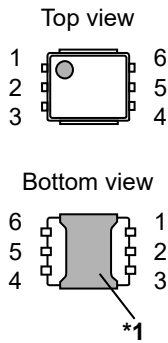

Figure 3

Pin No.	Symbol	Description	
		Input voltage pin	
1	VIN	Input voltage pin	
2	NC*2	No connection	
3	ADJ / EN	ADJ	Output voltage adjustment pin
		EN	Enable pin
4	VSS	GND pin	
5	NC*2	No connection	
6	VOUT	Output voltage pin	

*1. Connect the heat sink of backside at shadowed area to the board, and set electric potential GND. However, do not use it as the function of electrode.

*2. The NC pin is electrically open.
 The NC pin can be connected to the VIN pin or the VSS pin.

■ Absolute Maximum Ratings

Table 5

(Ta = +25°C unless otherwise specified)

Item	Symbol	Absolute Maximum Rating	Unit
Input voltage	V _{IN}	V _{SS} – 0.3 to V _{SS} + 45.0	V
	V _{ADJ / EN}	V _{SS} – 0.3 to V _{SS} + 45.0	V
Output voltage	V _{OUT}	V _{SS} – 0.3 to V _{SS} + 45.0	V
Output current	I _{OUT}	65	mA
Junction temperature	T _j	–40 to +150	°C
Operation ambient temperature	T _{opr}	–40 to +125	°C
Storage temperature	T _{stg}	–40 to +150	°C

Caution The absolute maximum ratings are rated values exceeding which the product could suffer physical damage. These values must therefore not be exceeded under any conditions.

■ Recommended Operation Conditions

Table 6

Item	Symbol	Condition	Min.	Typ.	Max.	Unit
VIN pin voltage	V _{IN}	–	4.0	–	36	V
ADJ / EN pin voltage	V _{ADJ / EN}	–	2.0	–	18	V
Output current*1	I _{OUT}	–	0.1	–	50	mA
Input capacitor	C _{IN}	–	1.0	–	–	μF
Output capacitor	C _L	–	1.0	–	1000	μF
	ESR	–	–	–	3	Ω

*1. Due to limitation of the power dissipation, this value may not be satisfied. Attention should be paid to the power dissipation when the output current is large.

■ Thermal Resistance Value

Table 7

Item	Symbol	Condition	Min.	Typ.	Max.	Unit	
Junction-to-ambient thermal resistance*1	θ _{JA}	SOT-23-5	Board A	–	192	–	°C/W
			Board B	–	160	–	°C/W
			Board C	–	–	–	°C/W
			Board D	–	–	–	°C/W
			Board E	–	–	–	°C/W
		HSNT-6(2025)	Board A	–	180	–	°C/W
			Board B	–	128	–	°C/W
			Board C	–	43	–	°C/W
			Board D	–	44	–	°C/W
			Board E	–	36	–	°C/W

*1. Test environment: compliance with JEDEC STANDARD JESD51-2A

Remark Refer to "■ Power Dissipation" and "Test Board" for details.

■ Electrical Characteristics

Table 8

($V_{IN} = 13.5\text{ V}$, $T_j = -40^\circ\text{C}$ to $+150^\circ\text{C}$ unless otherwise specified)

Item	Symbol	Condition	Min.	Typ.	Max.	Unit	Test Circuit	
Offset voltage*1	ΔV_{OUT}	$2.0\text{ V} \leq V_{ADJ/EN} \leq V_{IN} - 2.0\text{ V}$, $V_{ADJ/EN} \leq 18.0\text{ V}$	$4.0\text{ V} \leq V_{IN} \leq 24.0\text{ V}$, $0.1\text{ mA} \leq I_{OUT} \leq 50\text{ mA}$	-5	-	+5	mV	1
			$4.0\text{ V} \leq V_{IN} \leq 36.0\text{ V}$, $0.1\text{ mA} \leq I_{OUT} \leq 25\text{ mA}$	-5	-	+5	mV	1
Dropout voltage*2	V_{drop}	$V_{ADJ/EN} \geq 4.0\text{ V}$, $I_{OUT} = 10\text{ mA}$	-	160	300	mV	2	
Line regulation*3	ΔV_{OUT1}	$6.0\text{ V} \leq V_{IN} \leq 36.0\text{ V}$, $I_{OUT} = 10\text{ mA}$, $V_{ADJ/EN} = 5.0\text{ V}$	-	-	5	mV	2	
Load regulation*4	ΔV_{OUT2}	$0.1\text{ mA} \leq I_{OUT} \leq 50\text{ mA}$, $V_{ADJ/EN} = 5.0\text{ V}$	-	-	5	mV	2	
Input voltage	V_{IN}	-	4.0	-	36.0	V	-	
Current consumption during operation	I_{SS1}	$V_{ADJ/EN} = 5.0\text{ V}$, $I_{OUT} = 0.01\text{ mA}$	-	30	50	μA	3	
Reverse current	I_{REV}	$V_{IN} = 0\text{ V}$, $V_{ADJ/EN} = 5.0\text{ V}$, $V_{OUT} = 16.0\text{ V}$	-5	0	-	μA	4	
Current consumption during power-off	I_{SS2}	$V_{ADJ/EN} = 0\text{ V}$	-	4.0	15.0	μA	5	
ADJ / EN pin input voltage "H"	V_{ADJH}	Determined by V_{OUT} output level	2.0	-	-	V	6	
ADJ / EN pin input voltage "L"	V_{ADJL}	Determined by V_{OUT} output level	-	-	0.5	V	6	
ADJ / EN pin input current "H"	I_{ADJH}	$V_{ADJ/EN} = 5.0\text{ V}$	-0.1	-	2	μA	6	
ADJ / EN pin input current "L"	I_{ADJL}	$V_{ADJ/EN} = 0\text{ V}$	-0.1	-	0.1	μA	6	
Ripple rejection	$ RR $	$f = 100\text{ Hz}$, $\Delta V_{rip} = 0.5\text{ V}_{pp}$, $I_{OUT} = 5\text{ mA}$	-	80	-	dB	7	
Limit current	I_{LIM}	$V_{IN} = 7.0\text{ V}$, $V_{ADJ/EN} = 5.0\text{ V}$, $V_{OUT} = V_{ADJ/EN} \times 0.85$	80	180	330	mA	8	
Short-circuit current	I_{short}	$V_{IN} = 7.0\text{ V}$, $V_{ADJ/EN} = 5.0\text{ V}$, $V_{OUT} = 0\text{ V}$	80	180	330	mA	8	
Thermal shutdown detection temperature	T_{SD}	Junction temperature	-	175	-	$^\circ\text{C}$	-	
Thermal shutdown release temperature	T_{SR}	Junction temperature	-	165	-	$^\circ\text{C}$	-	

- *1. Indicates the difference between output voltage (V_{OUT}) and ADJ / EN pin voltage ($V_{ADJ/EN}$).
 The accuracy is guaranteed when the input voltage, output current, and temperature satisfy the conditions listed above.

$$\Delta V_{OUT} = V_{OUT} - V_{ADJ/EN}$$
- *2. Indicates the difference between input voltage (V_{IN1}) and the output voltage when the output voltage becomes 98% of the output voltage value (V_{OUT3}) after the input voltage (V_{IN}) is decreased gradually.

$$V_{drop} = V_{IN1} - (V_{OUT3} \times 0.98)$$

$$V_{OUT3}: \text{Output voltage value at } V_{IN} = V_{ADJ/EN} + 2.0\text{ V, and } I_{OUT} = 10\text{ mA}$$
- *3. Indicates the dependency of the output voltage against the input voltage. The value shows how much the output voltage changes due to a change in the input voltage after fixing output current constant.
- *4. Indicates the dependency of the output voltage against the output current. The value shows how much the output voltage changes due to a change in the output current after fixing input voltage constant.

■ Test Circuits

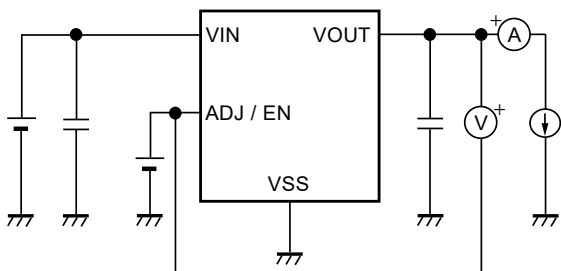

Figure 4 Test Circuit 1

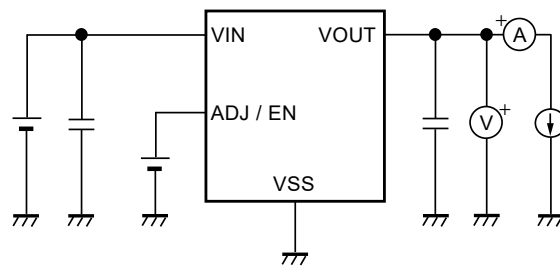

Figure 5 Test Circuit 2

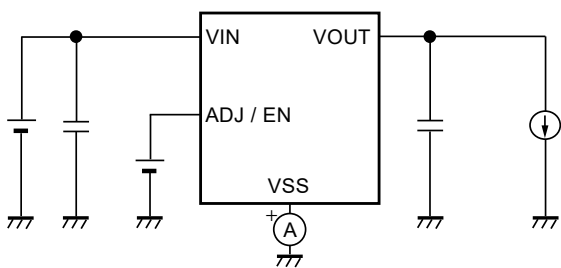

Figure 6 Test Circuit 3

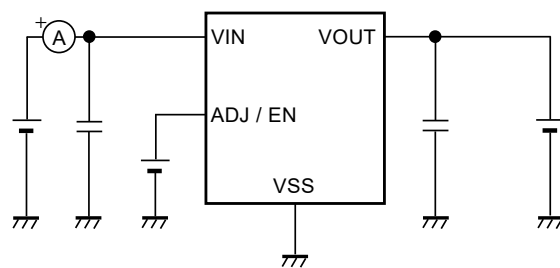

Figure 7 Test Circuit 4

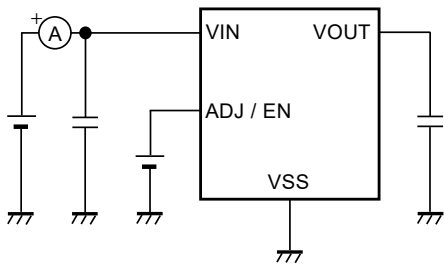

Figure 8 Test Circuit 5

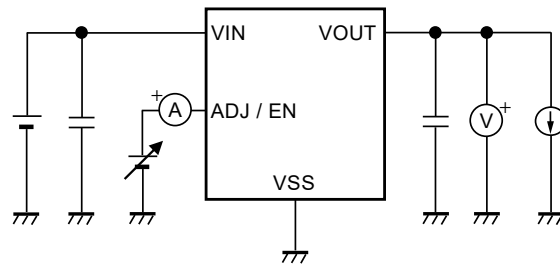

Figure 9 Test Circuit 6

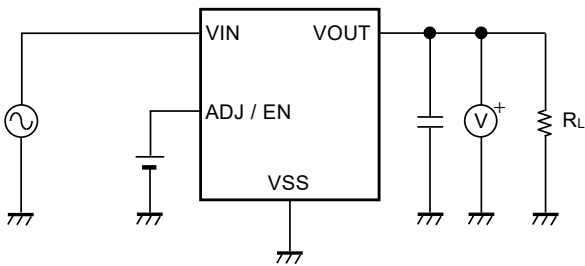

Figure 10 Test Circuit 7

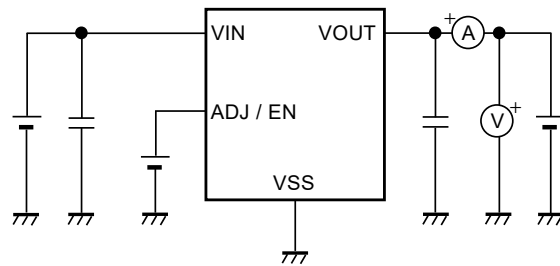
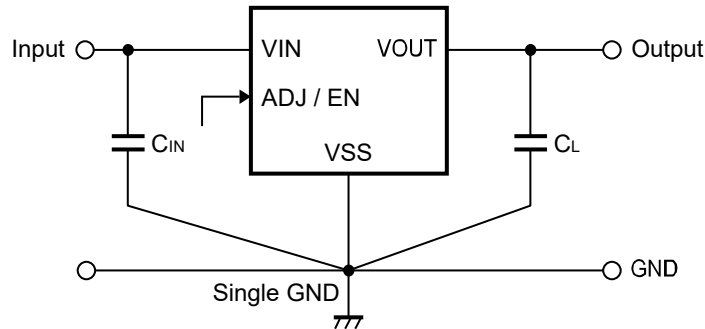

Figure 11 Test Circuit 8

■ Standard Circuit



- *1. C_{IN} is a capacitor for stabilizing the input.
- *2. C_L is a capacitor for stabilizing the output.

Figure 12

Caution The above connection diagram and constants will not guarantee successful operation. Perform thorough evaluation using an actual application to set the constants.

■ Condition of Application

Input capacitor (C_{IN}): A ceramic capacitor with capacitance of 1.0 μF or more is recommended.

Output capacitor (C_L): A ceramic capacitor with capacitance of 1.0 μF to 1000 μF is recommended.

Caution Generally, in a voltage tracker, an oscillation may occur depending on the selection of the external parts. Perform thorough evaluation including the temperature characteristics with an actual application using the above capacitors to confirm no oscillation occurs.

■ Selection of Input Capacitor (C_{IN}) and Output Capacitor (C_L)

This IC requires C_L between the VOUT pin and the VSS pin for phase compensation. The operation is stabilized by a ceramic capacitor with capacitance of 1.0 μF to 1000 μF over the entire temperature range. When using an OS capacitor, a tantalum capacitor or an aluminum electrolytic capacitor, the capacitance also must be 1.0 μF to 1000 μF . However, an oscillation may occur depending on the equivalent series resistance (ESR).

Moreover, this IC requires C_{IN} between the VIN pin and the VSS pin for a stable operation.

Generally, an oscillation may occur when a voltage tracker is used under the condition that the impedance of the power supply is high.

Note that the output voltage transient characteristics varies depending on the capacitance of C_{IN} and C_L and the value of ESR.

Caution Perform thorough evaluation including the temperature characteristics with an actual application to select C_{IN} and C_L .

■ Operation

1. Basic operation

Figure 13 shows the block diagram of this IC to describe the basic operation.

The error amplifier compares the output voltage (V_{OUT}) with the ADJ / EN pin voltage ($V_{ADJ/EN}$).

The error amplifier controls the output transistor to keep V_{OUT} equal to $V_{ADJ/EN}$ without being affected by the input voltage (V_{IN}), that is, the tracking operation is performed.

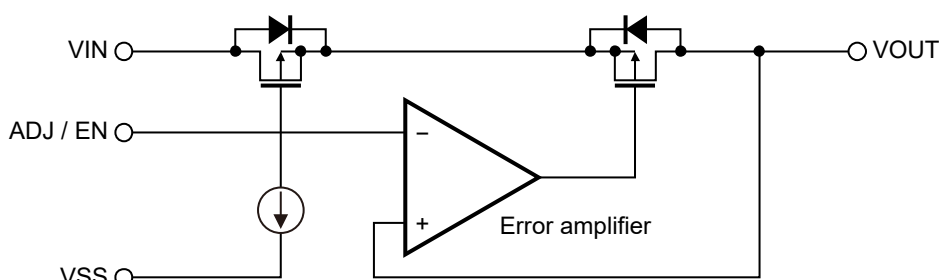

Figure 13

2. Output transistor

In this IC, a low on-resistance P-channel MOS FET is used between the VIN pin and the VOUT pin as the output transistor. In order to maintain the tracking operation of $V_{ADJ/EN}$ and V_{OUT} , the on-resistance of the output transistor varies appropriately according to the output current (I_{OUT}).

Also, the reverse current prevention transistor is connected in series with the output transistor.

3. ADJ / EN pin

The ADJ / EN pin controls the internal circuit and the output transistor in order to start and stop the tracker.

When the ADJ / EN pin is set to ON ($V_{ADJ/EN} \geq V_{ADJH}$), the tracking operation starts and V_{OUT} is adjusted so that it becomes equal to $V_{ADJ/EN}$.

When the ADJ / EN pin is set to OFF, the internal circuit stops operating and the output transistor between the VIN pin and the VOUT pin is turned off, reducing current consumption significantly.

The ADJ / EN pin is internally pulled down to the VSS pin in the floating status, so the VOUT pin is set to the V_{SS} level.

Table 9

ADJ / EN Pin	Internal Circuit	V_{OUT}	Current Consumption
"H": ON	Operate	$\cong V_{ADJ/EN}$	I_{SS1}
"L": OFF	Stop	V_{SS}^{*1}	I_{SS2}

*1. The VOUT pin is not pulled down internally. The VOUT pin voltage changes to V_{SS} level by the load connected to the VOUT pin.

4. Overcurrent protection circuit

This IC includes an overcurrent protection circuit which having the characteristics shown in "1. Output voltage vs. Output current (When load current increases) (Ta = +25°C)" in "■ Characteristics (Typical Data)", in order to limit an excessive output current and overcurrent of the output transistor due to short-circuiting between the VOUT pin and the VSS pin.

When the load current increases and reaches the limit current (ILIM), the overcurrent protection circuit operates, and the output current is limited based on ILIM. When the output is short-circuited (the VOUT pin is shorted to the VSS pin), the output current is limited to short-circuit current (Ishort). ILIM and Ishort are internally set at 180 mA typ.

This IC restarts the tracking operation over VOUT and VADJ / EN when the output transistor is released from the overcurrent status.

Caution This overcurrent protection circuit does not work as for thermal protection. If this IC long keeps short circuiting inside, pay attention to the conditions of input voltage and load current so that, under the usage conditions including short circuit, the loss of the IC will not exceed power dissipation of the package.

5. Thermal shutdown circuit

This IC has a built-in thermal shutdown circuit to limit overheating. When the junction temperature increases to 175°C typ., the thermal shutdown circuit becomes the detection status, and the tracking operation is stopped. When the junction temperature decreases to 165°C typ., the thermal shutdown circuit becomes the release status, and the tracking operation is restarted.

If the thermal shutdown circuit becomes the detection status due to self-heating, the tracking operation is stopped and VOUT decreases. For this reason, the self-heating is limited and the temperature of the IC decreases. The thermal shutdown circuit becomes release status when the temperature of the IC decreases, and the tracking operation is restarted, thus the self-heating is generated again. Repeating this procedure makes the waveform of VOUT into a pulse-like form. This phenomenon continues unless decreasing either or both of VIN and IOUT in order to reduce the internal power consumption, or decreasing the ambient temperature. Note that the product may suffer physical damage such as deterioration if the above phenomenon occurs continuously.

Caution If a large load current flows during the restart process of the tracking operation after the thermal shutdown circuit changes to the release status from the detection status, the thermal shutdown circuit becomes the detection status again due to self-heating, and a problem may happen in the restart of the tracking operation. A large load current, for example, occurs when charging to the CL whose capacitance is large.

Perform thorough evaluation including the temperature characteristics with an actual application to select CL.

Table 10

Thermal Shutdown Circuit	VOUT
Release: 165°C typ.*1	≅ VADJ / EN
Detection: 175°C typ.*1	VSS*2

*1. Junction temperature

*2. The VOUT pin is not pulled down internally.

The VOUT pin voltage changes to VSS level by the load connected to the VOUT pin.

6. Reverse current protection function

The reverse current protection function compares values of V_{IN} and V_{OUT} , and prevents the current from flowing to the VIN pin from the VOUT pin.

During the reverse current protection mode, the reverse current detection circuit turns off the reverse current protection transistor between the VIN pin and the output transistor and blocks the reverse current from the VOUT pin.

In the case of $V_{OUT} - V_{IN} < V_{REVD}$, this IC is in normal operation mode (refer to **Figure 14**). The reverse current protection mode is detected when $V_{OUT} - V_{IN} \geq V_{REVD}$ (refer to **Figure 15**). In order to insure the stable operation, there is also a hysteresis for detection and release of the reverse current protection mode. Therefore, the reverse current protection mode is released when $V_{OUT} - V_{IN} \leq V_{REVR}$.

The reverse current protection function also operates when the ADJ / EN pin is set to OFF level.

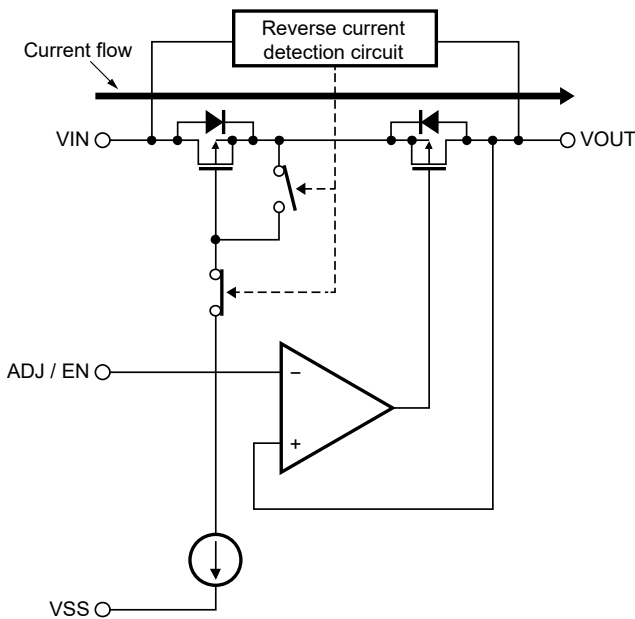

Figure 14 Normal Operation Mode

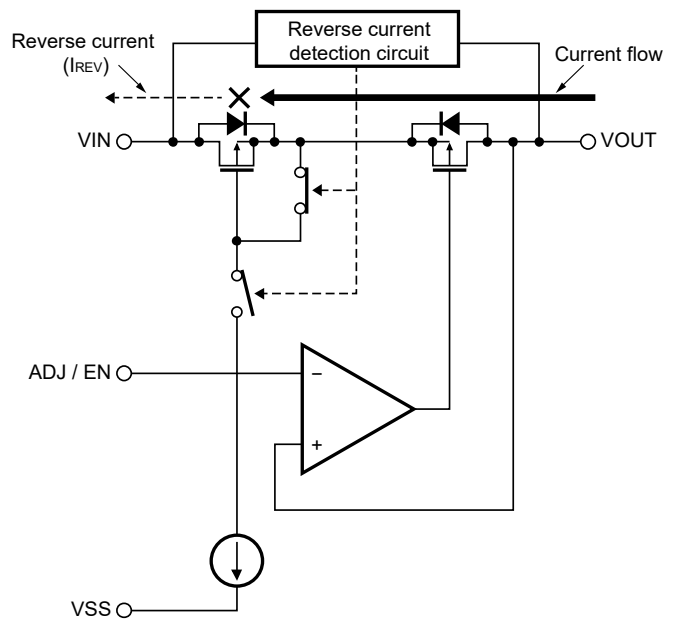

Figure 15 Reverse Current Protection Mode

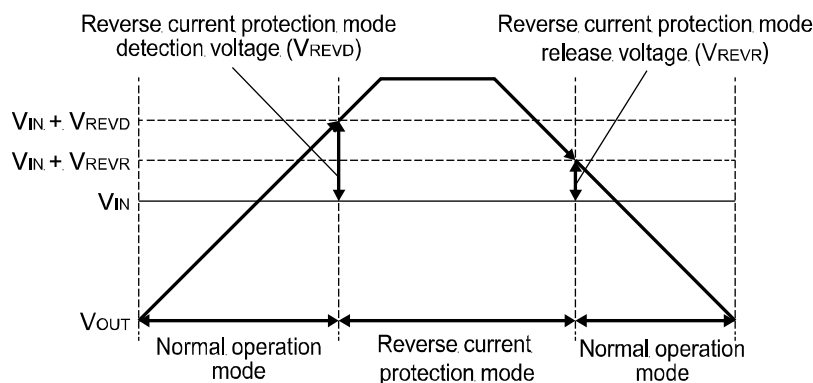

Figure 16

Table 11

Reverse current protection mode detection voltage (V_{REVD})	Reverse current protection mode release voltage (V_{REVR})
0.50 V typ.	0.33 V typ.

■ Precautions

- Generally, when a voltage tracker is used under the condition that the load current value is small (0.1 mA or less), the output voltage may increase due to the leakage current of an output transistor.
- Generally, when a voltage tracker is used under the condition that the temperature is high, the output voltage may increase due to the leakage current of an output transistor.
- Generally, when the ADJ / EN pin of a voltage tracker is used under the condition of OFF, the output voltage may increase due to the leakage current of an output transistor.
- Generally, when a voltage tracker is used under the condition that the impedance of the power supply is high, an oscillation may occur. Perform thorough evaluation including the temperature characteristics with an actual application to select C_{IN} .
- Generally, in a voltage tracker, an oscillation may occur depending on the selection of the external parts. The following use conditions are recommended in this IC, however, perform thorough evaluation including the temperature characteristics with an actual application to select C_{IN} and C_L .
 - Input capacitor (C_{IN}): A ceramic capacitor with capacitance of 1.0 μ F or more is recommended.
 - Output capacitor (C_L): A ceramic capacitor with capacitance of 1.0 μ F to 1000 μ F is recommended.
- Generally, in a voltage tracker, the values of an overshoot and an undershoot in the output voltage vary depending on the variation factors of input voltage start-up, input voltage fluctuation and load fluctuation etc., or the capacitance of C_{IN} or C_L and the value of the equivalent series resistance (ESR), which may cause a problem to the stable operation. Perform thorough evaluation including the temperature characteristics with an actual application to select C_{IN} and C_L .
- Generally, in a voltage tracker, an overshoot may occur in the output voltage momentarily if the input voltage steeply changes when the input voltage is started up or the input voltage fluctuates etc. Perform thorough evaluation including the temperature characteristics with an actual application to confirm no problems happen.
- Generally, in a voltage tracker, if the VOUT pin is steeply shorted with GND, a negative voltage exceeding the absolute maximum ratings may occur in the VOUT pin due to resonance phenomenon of the inductance and the capacitance including C_L on the application. The resonance phenomenon is expected to be weakened by inserting a series resistor into the resonance path, and the negative voltage is expected to be limited by inserting a protection diode between the VOUT pin and the VSS pin.
- If the input voltage is started up steeply under the condition that the capacitance of C_L is large, the thermal shutdown circuit may be in the detection status by self-heating due to the charge current to C_L .
- Make sure of the conditions for the input voltage, output voltage and the load current so that the internal loss does not exceed the power dissipation.
- Do not apply an electrostatic discharge to this IC that exceeds the performance ratings of the built-in electrostatic protection circuit.
- When considering the output current value that this IC is able to output, make sure of the output current value specified in **Table 6** in "■ Recommended Operation Conditions" and footnote *1 of the table.
- Wiring patterns on the application related to the VIN pin, the VOUT pin and the VSS pin should be designed so that the impedance is low. When mounting C_{IN} between the VIN pin and the VSS pin and C_L between the VOUT pin and the VSS pin, connect the capacitors as close as possible to the respective destination pins of this IC.
- In the package equipped with heat sink of backside, mount the heat sink firmly. Since the heat radiation differs according to the condition of the application, perform thorough evaluation with an actual application to confirm no problems happen.
- ABLIC Inc. claims no responsibility for any disputes arising out of or in connection with any infringement by products including this IC of patents owned by a third party.

■ Characteristics (Typical Data)

1. Output voltage vs. Output current (When load current increases) (Ta = +25°C)

1.1 V_{ADJ/EN} = 5.0 V

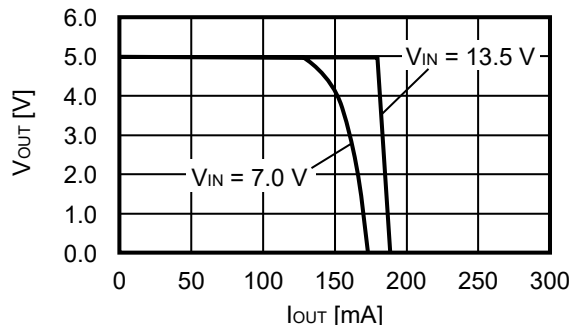

Remark In determining the output current, attention should be paid to the following.

1. The output current value and footnote *1 of Table 6 in "■ Recommended Operation Conditions"
2. Power dissipation

2. Output voltage vs. Input voltage (Ta = +25°C)

2.1 V_{ADJ/EN} = 5.0 V

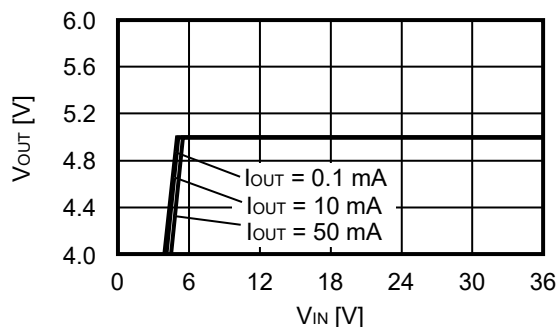

3. Output voltage vs. ADJ / EN pin input voltage (Ta = +25°C)

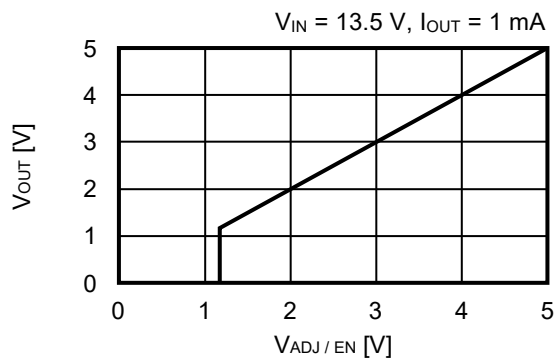

4. Dropout voltage vs. Output current

4.1 $V_{ADJ/EN} = 5.0\text{ V}$

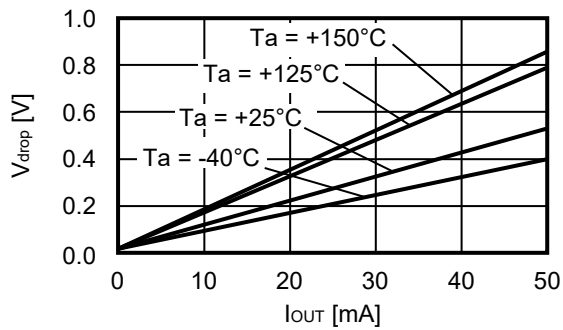

5. Dropout voltage vs. Junction temperature

5.1 $V_{ADJ/EN} = 5.0\text{ V}$

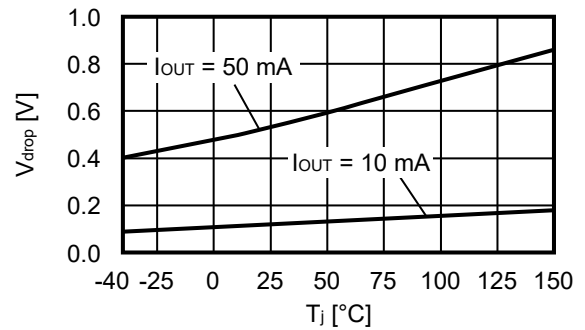

6. Dropout voltage vs. Set output voltage ($T_a = +25^\circ\text{C}$)

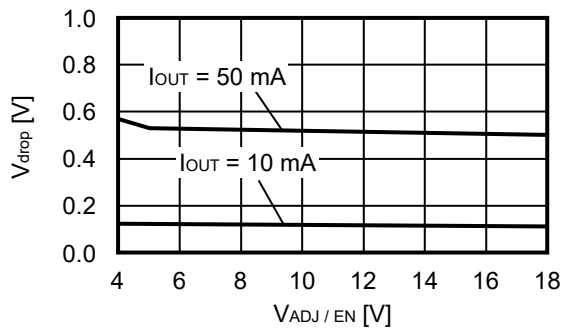

7. Offset voltage vs. Junction temperature

7.1 $V_{ADJ/EN} = 5.0\text{ V}$

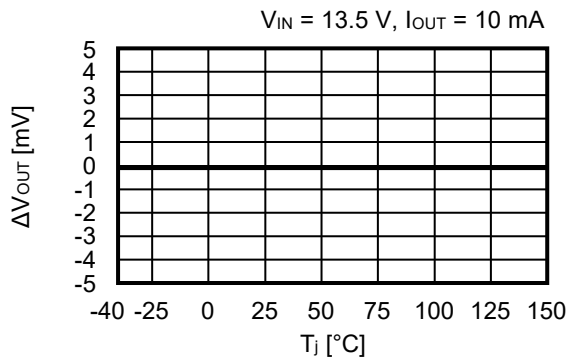

8. Offset voltage vs. Input voltage ($T_a = +25^\circ\text{C}$)

8.1 $V_{ADJ/EN} = 5.0\text{ V}$

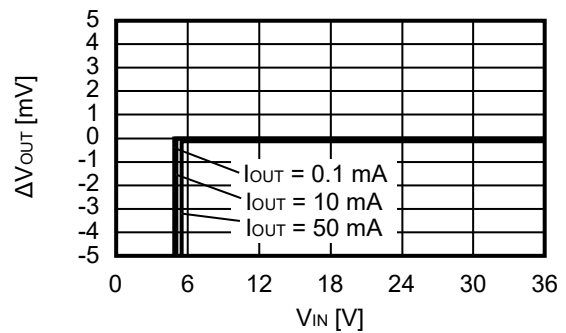

9. Offset voltage vs. Output current ($T_a = +25^\circ\text{C}$)

9.1 $V_{ADJ/EN} = 5.0\text{ V}$

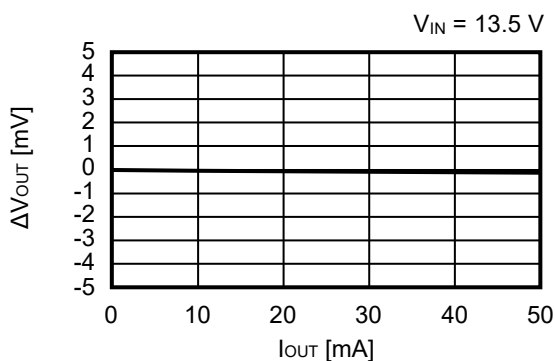

10. Current consumption vs. Input voltage

10.1 $V_{ADJ/EN} = 5.0\text{ V}$ (during operation)

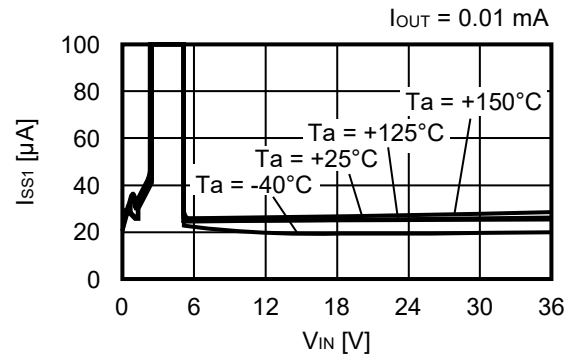
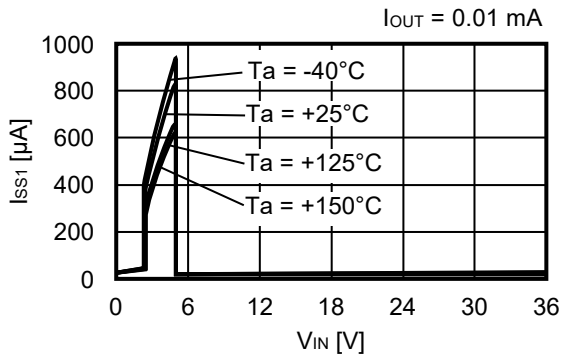

10.2 $V_{ADJ/EN} = 0.0\text{ V}$ (Power-off)

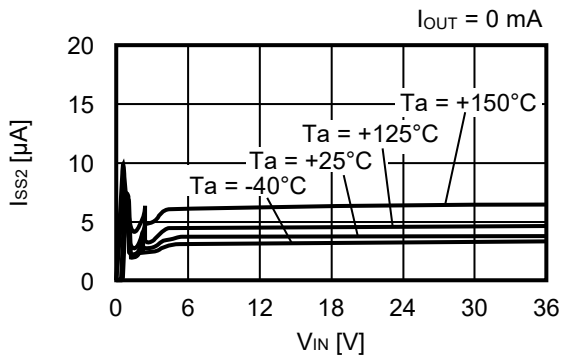

11. Current consumption vs. Junction temperature

11.1 $V_{ADJ/EN} = 5.0\text{ V}$ (during operation)

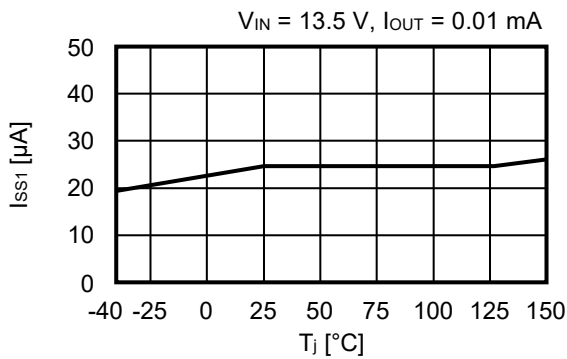

11.2 $V_{ADJ/EN} = 0.0\text{ V}$ (Power-off)

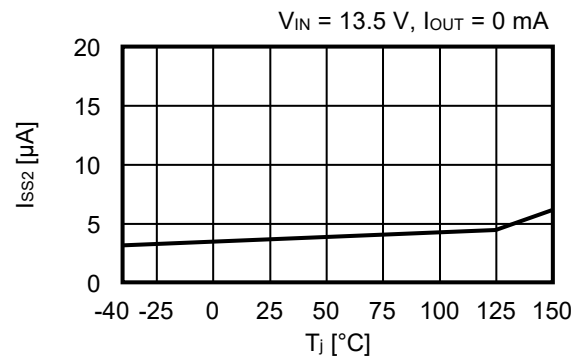

12. Current consumption during operation vs. Output current ($T_a = +25^\circ\text{C}$)

12.1 $V_{ADJ/EN} = 5.0\text{ V}$

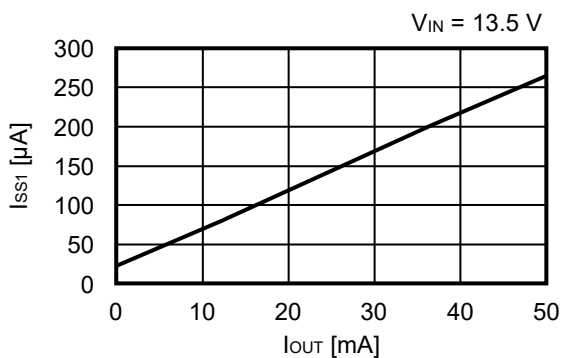

13. Reverse current vs. VOUT pin voltage

13.1 V_{ADJ/EN} = 5.0 V

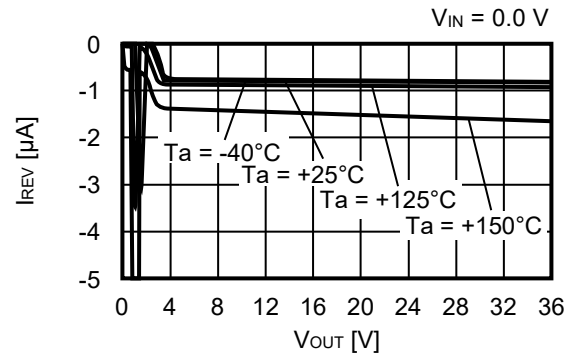
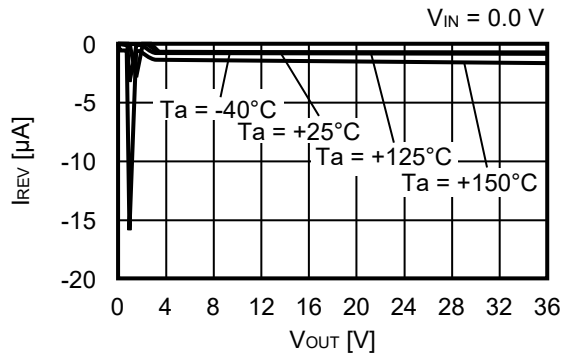

14. ADJ / EN pin current vs. ADJ / EN pin voltage

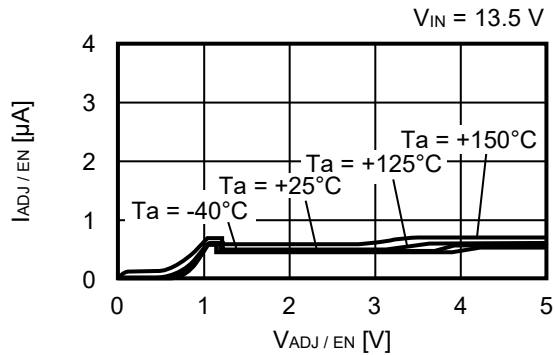

15. Ripple rejection (Ta = +25°C)

15.1 V_{ADJ/EN} = 5.0 V

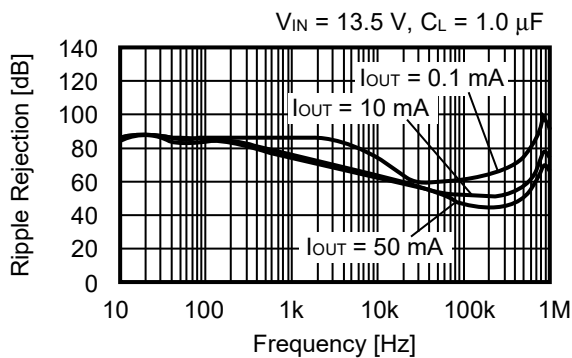

■ Reference Data

1. Characteristics of input transient response (Ta = +25°C) 2. Characteristics of load transient response (Ta = +25°C)

1.1 V_{ADJ/EN} = 5.0 V

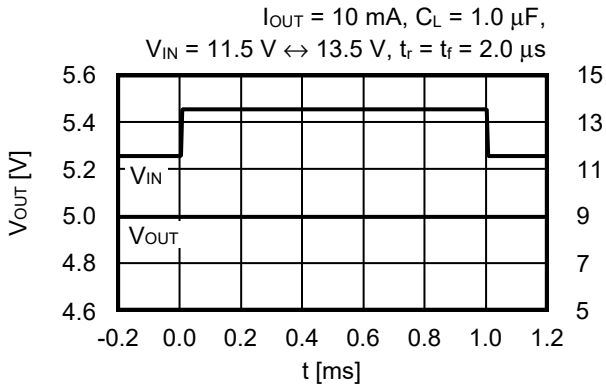

2.1 V_{ADJ/EN} = 5.0 V

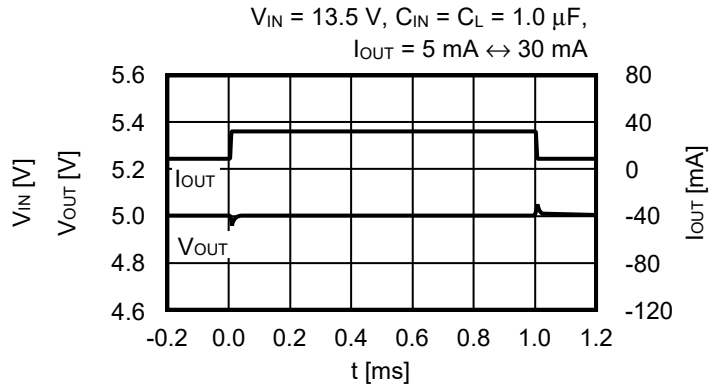

3. Transient response characteristics of ADJ / EN pin (Ta = +25°C)

3.1 V_{ADJ/EN} = 5.0 V

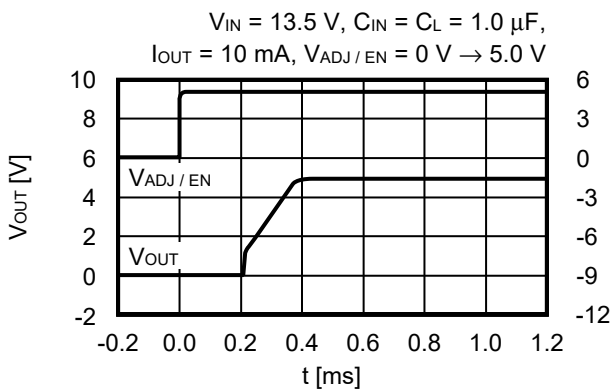

4. Load dump characteristics (Ta = +25°C)

4.1 V_{ADJ/EN} = 5.0 V

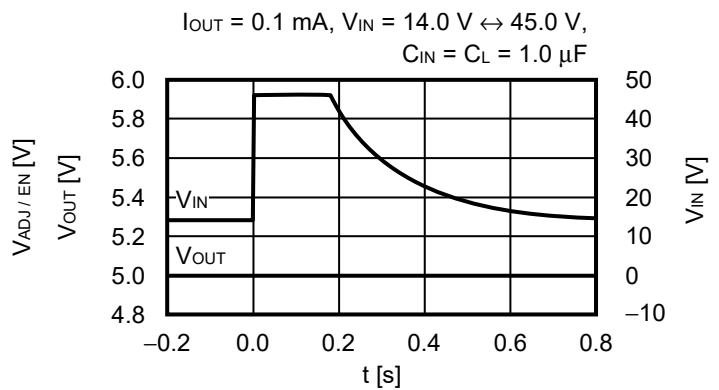

5. Example of equivalent series resistance vs. Output current characteristics (Ta = -40°C to +125°C)

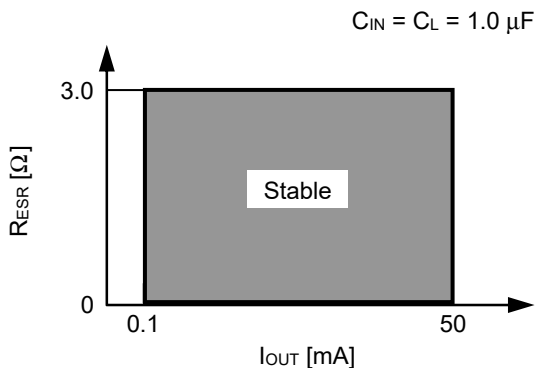
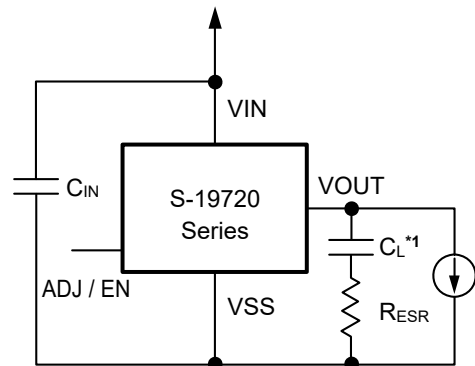

Figure 17



*1. C_L: TDK Corporation CGA5L3X8R1H105K (1.0 μF)

Figure 18

■ Power Dissipation

SOT-23-5

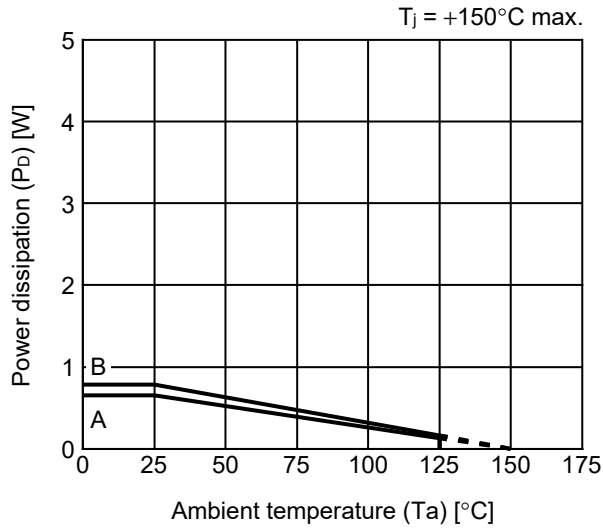

Board	Power Dissipation (P_D)
A	0.65 W
B	0.78 W
C	–
D	–
E	–

HSNT-6(2025)

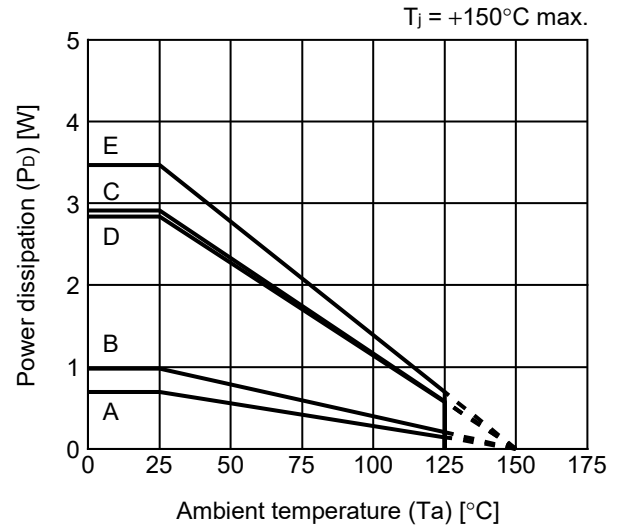

Board	Power Dissipation (P_D)
A	0.69 W
B	0.98 W
C	2.91 W
D	2.84 W
E	3.47 W

SOT-23-3/3S/5/6 Test Board

 IC Mount Area

(1) Board A



Item		Specification
Size [mm]		114.3 x 76.2 x t1.6
Material		FR-4
Number of copper foil layer		2
Copper foil layer [mm]	1	Land pattern and wiring for testing: t0.070
	2	-
	3	-
	4	74.2 x 74.2 x t0.070
Thermal via		-

(2) Board B



Item		Specification
Size [mm]		114.3 x 76.2 x t1.6
Material		FR-4
Number of copper foil layer		4
Copper foil layer [mm]	1	Land pattern and wiring for testing: t0.070
	2	74.2 x 74.2 x t0.035
	3	74.2 x 74.2 x t0.035
	4	74.2 x 74.2 x t0.070
Thermal via		-

No. SOT23x-A-Board-SD-2.0

HSNT-6(2025) Test Board

 IC Mount Area

(1) Board A

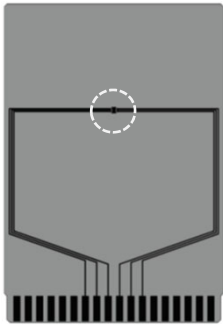

Item	Specification	
Size [mm]	114.3 x 76.2 x t1.6	
Material	FR-4	
Number of copper foil layer	2	
Copper foil layer [mm]	1	Land pattern and wiring for testing: t0.070
	2	-
	3	-
	4	74.2 x 74.2 x t0.070
Thermal via	-	

(2) Board B

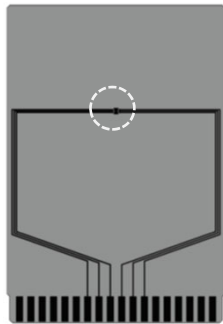

Item	Specification	
Size [mm]	114.3 x 76.2 x t1.6	
Material	FR-4	
Number of copper foil layer	4	
Copper foil layer [mm]	1	Land pattern and wiring for testing: t0.070
	2	74.2 x 74.2 x t0.035
	3	74.2 x 74.2 x t0.035
	4	74.2 x 74.2 x t0.070
Thermal via	-	

(3) Board C

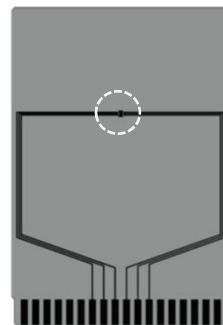

Item	Specification	
Size [mm]	114.3 x 76.2 x t1.6	
Material	FR-4	
Number of copper foil layer	4	
Copper foil layer [mm]	1	Land pattern and wiring for testing: t0.070
	2	74.2 x 74.2 x t0.035
	3	74.2 x 74.2 x t0.035
	4	74.2 x 74.2 x t0.070
Thermal via	Number: 4 Diameter: 0.3 mm	



enlarged view

No. HSNT6-B-Board-SD-1.0

HSNT-6(2025) Test Board

 IC Mount Area

(4) Board D

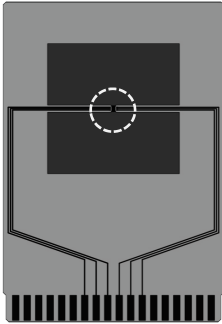

Item	Specification	
Size [mm]	114.3 x 76.2 x t1.6	
Material	FR-4	
Number of copper foil layer	4	
Copper foil layer [mm]	1	Pattern for heat radiation: 2000mm ² t0.070
	2	74.2 x 74.2 x t0.035
	3	74.2 x 74.2 x t0.035
	4	74.2 x 74.2 x t0.070
Thermal via	-	



enlarged view

(5) Board E

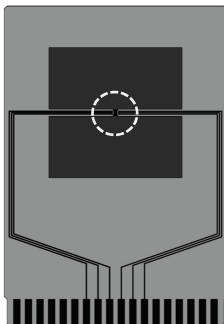

Item	Specification	
Size [mm]	114.3 x 76.2 x t1.6	
Material	FR-4	
Number of copper foil layer	4	
Copper foil layer [mm]	1	Pattern for heat radiation: 2000mm ² t0.070
	2	74.2 x 74.2 x t0.035
	3	74.2 x 74.2 x t0.035
	4	74.2 x 74.2 x t0.070
Thermal via	Number: 4 Diameter: 0.3 mm	



enlarged view

No. HSNT6-B-Board-SD-1.0

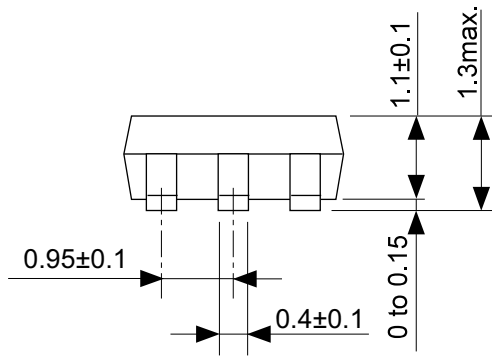
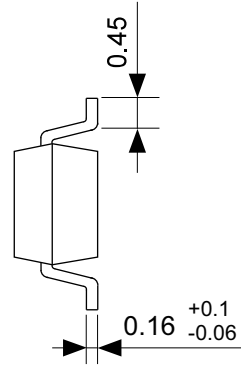
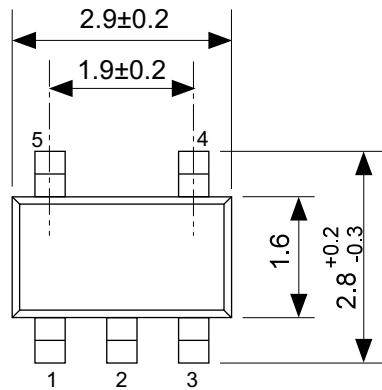

No. MP005-A-P-SD-1.3

TITLE	SOT235-A-PKG Dimensions
No.	MP005-A-P-SD-1.3
ANGLE	
UNIT	mm
ABLIC Inc.	

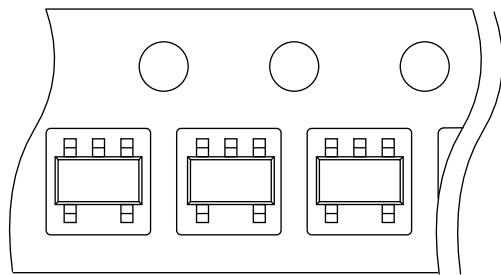
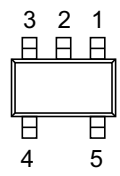
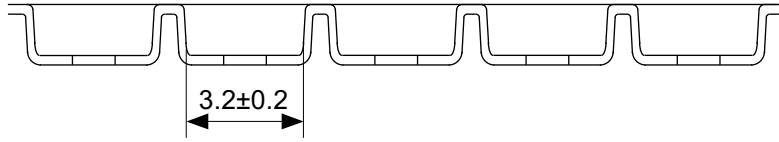
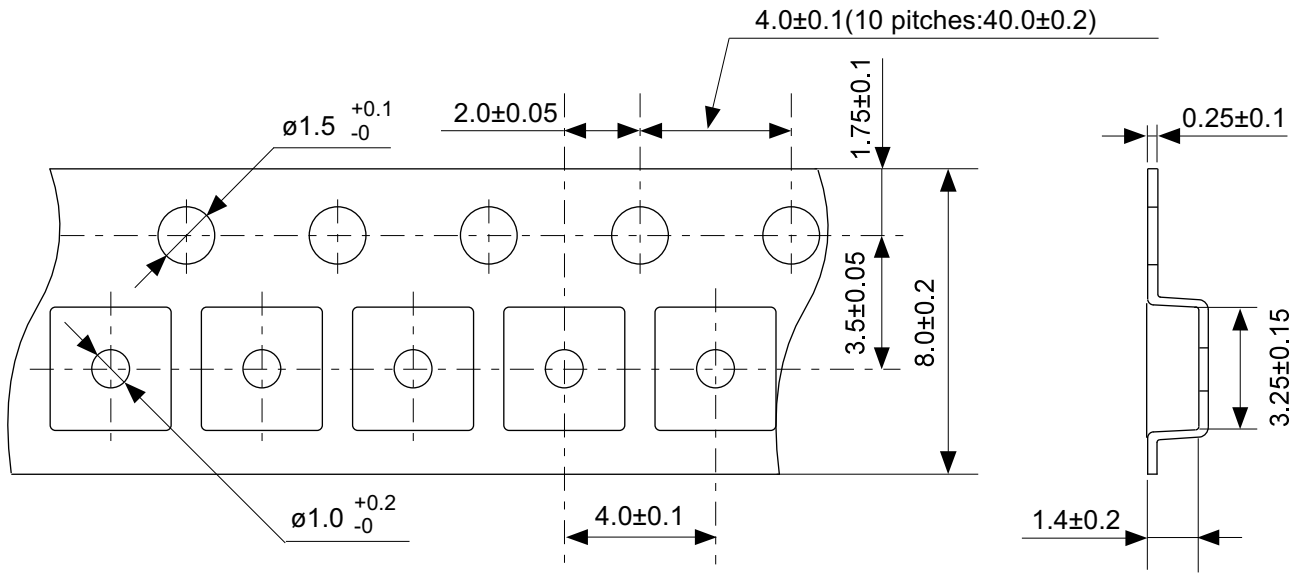

→
Feed direction

No. MP005-A-C-SD-2.1

TITLE	SOT235-A-Carrier Tape
No.	MP005-A-C-SD-2.1
ANGLE	
UNIT	mm

ABLIC Inc.

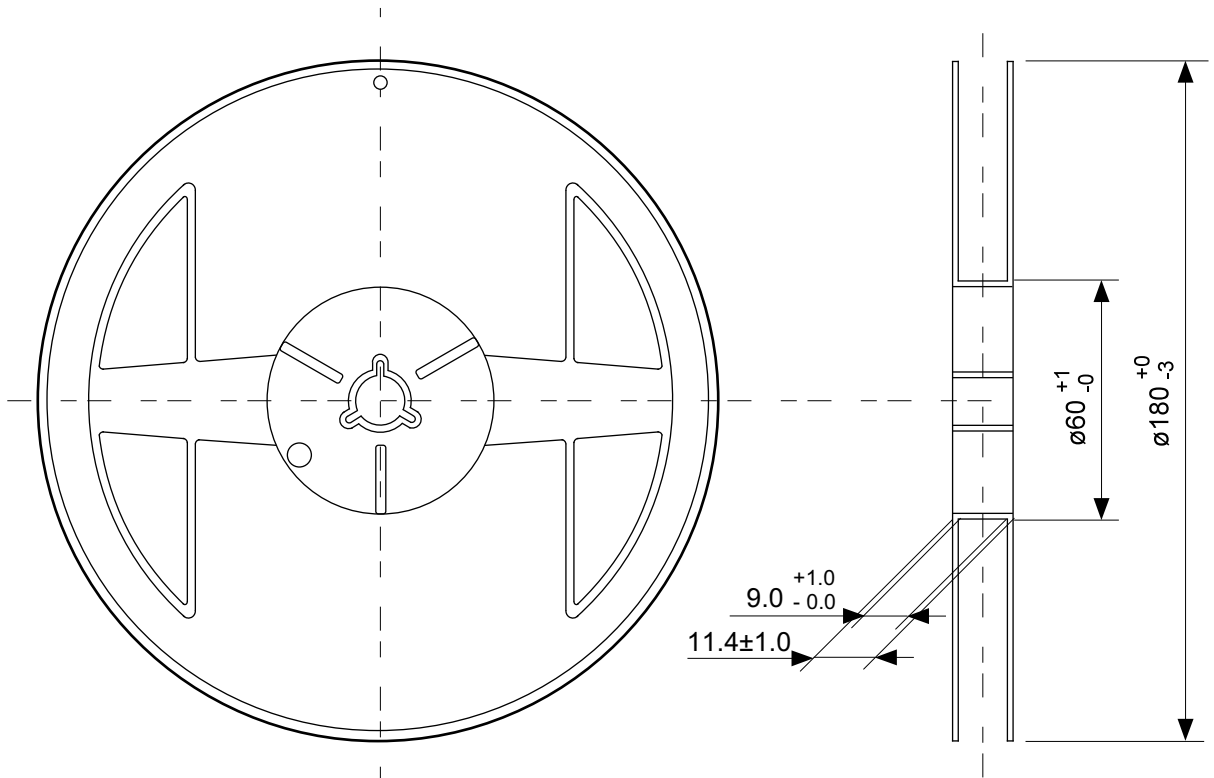

Enlarged drawing in the central part

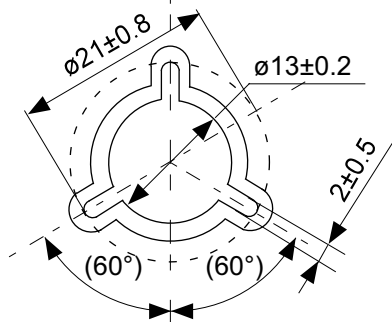

No. MP005-A-R-SD-2.0

TITLE	SOT235-A-Reel		
No.	MP005-A-R-SD-2.0		
ANGLE		QTY.	3,000
UNIT	mm		
ABLIC Inc.			

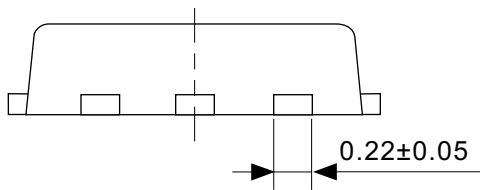
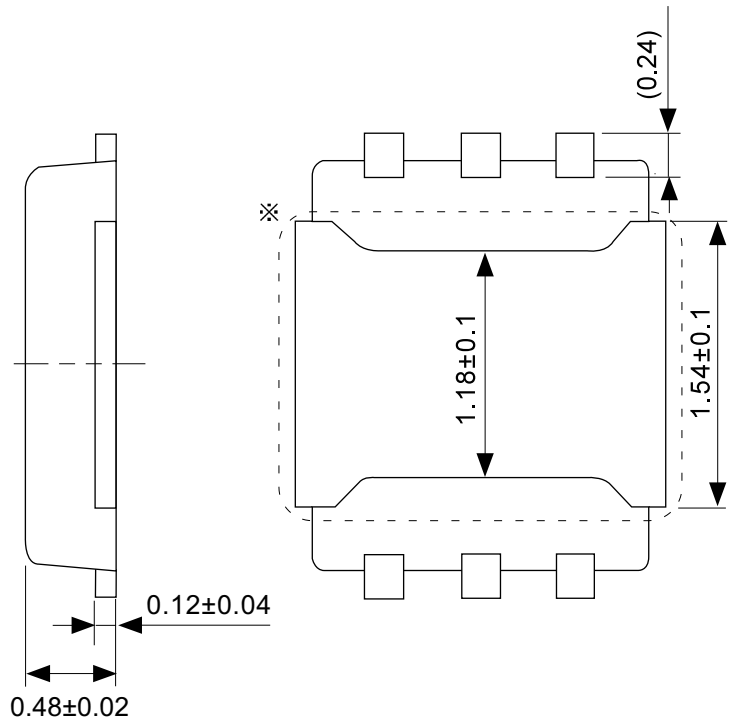
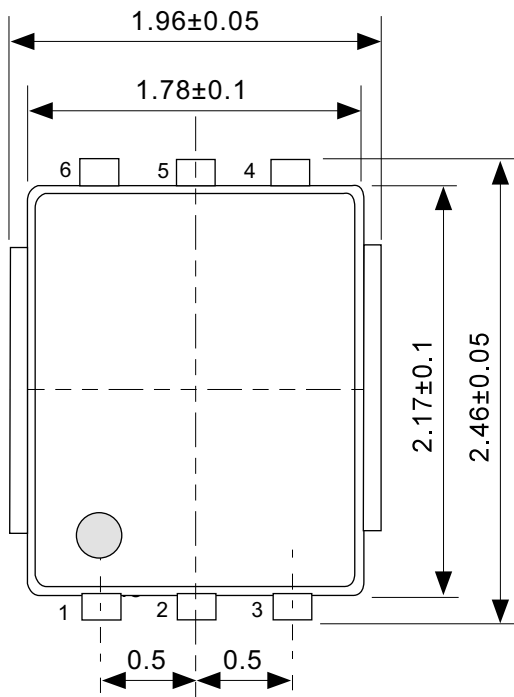

※ The heat sink of back side has different electric potential depending on the product.
 Confirm specifications of each product.
 Do not use it as the function of electrode.

No. PJ006-B-P-SD-1.0

TITLE	HSNT-6-C-PKG Dimensions
No.	PJ006-B-P-SD-1.0
ANGLE	
UNIT	mm
ABLIC Inc.	

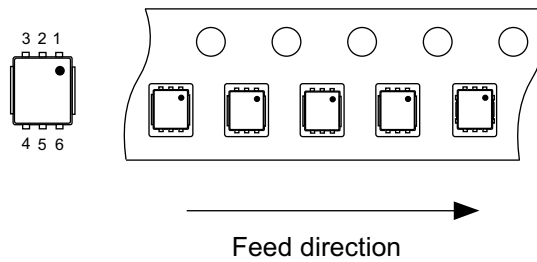
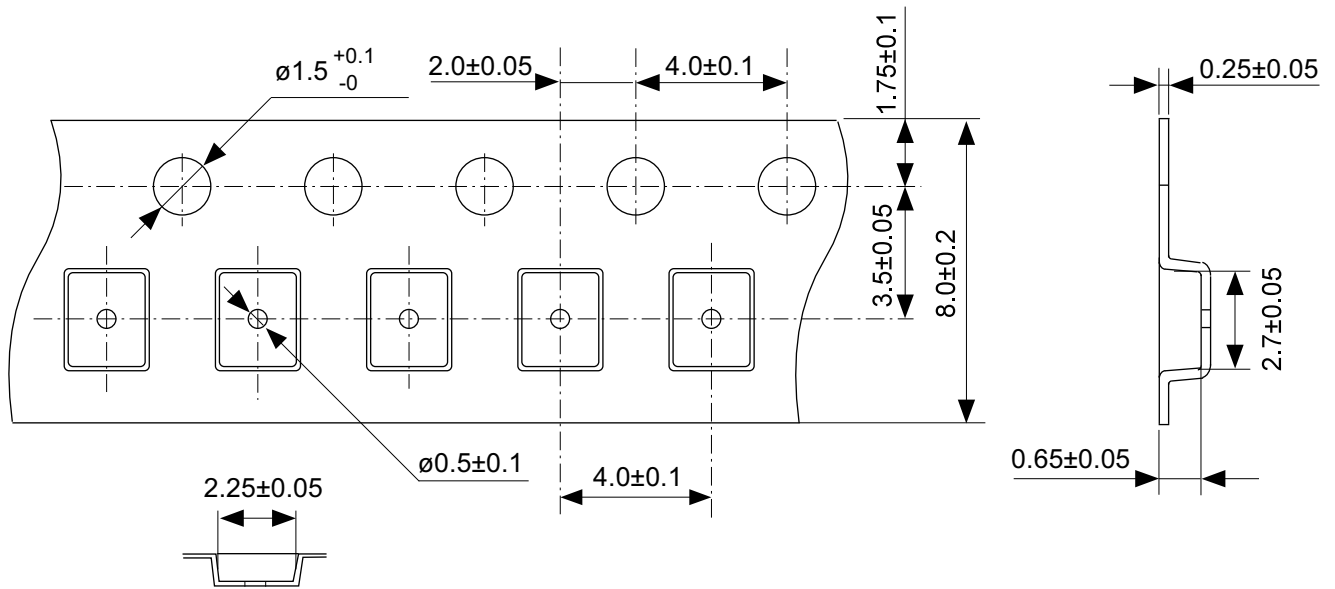

No. PJ006-B-C-SD-1.0

TITLE	HSNT-6-C-Carrier Tape
No.	PJ006-B-C-SD-1.0
ANGLE	
UNIT	mm
ABLIC Inc.	

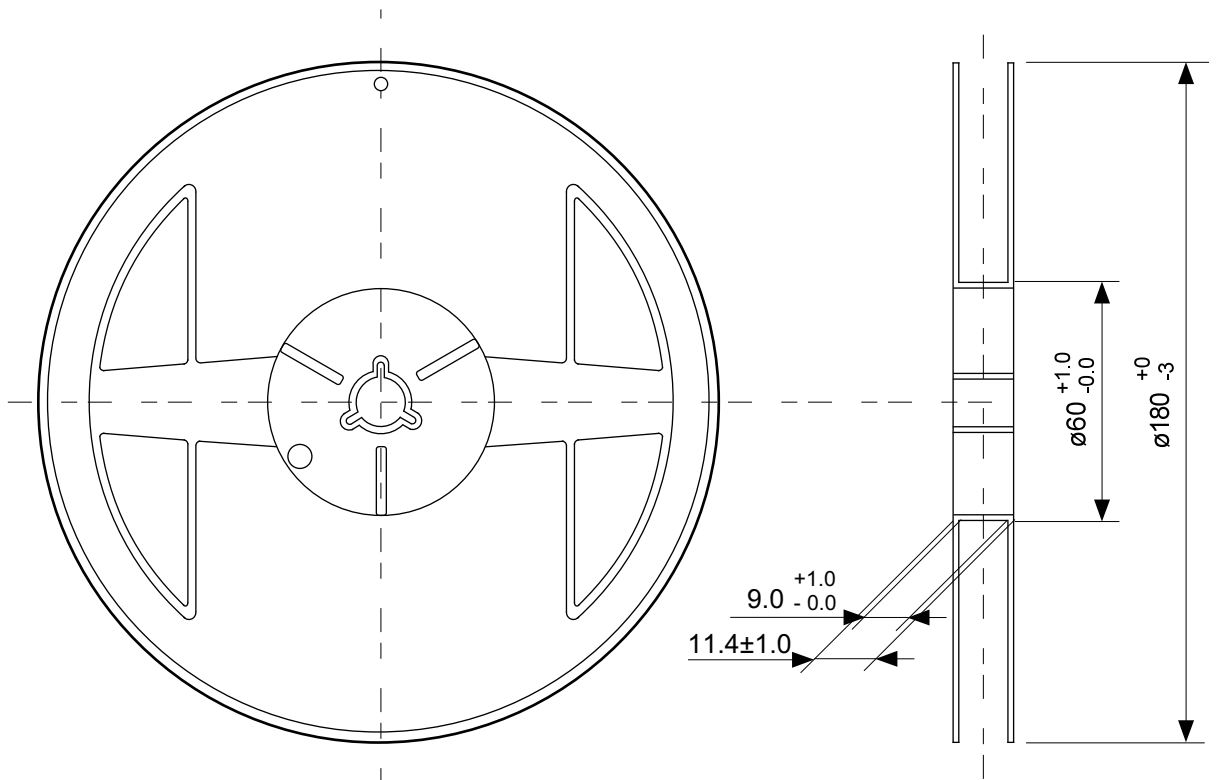

Enlarged drawing in the central part

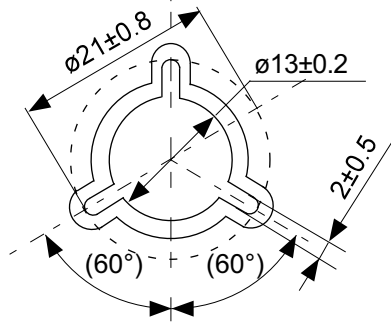

No. PJ006-B-R-SD-1.0

TITLE	HSNT-6-C-Reel		
No.	PJ006-B-R-SD-1.0		
ANGLE		QTY.	5,000
UNIT	mm		
ABLIC Inc.			

Land Recommendation

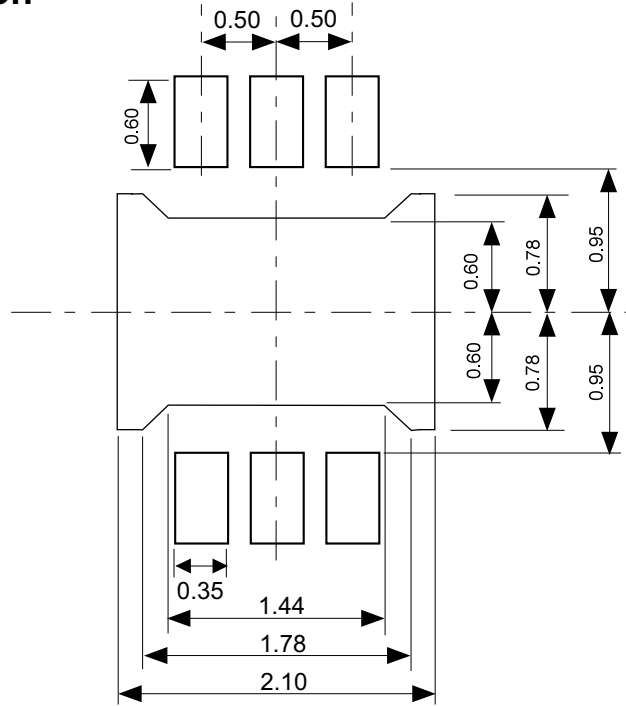

Caution It is recommended to solder the heat sink to a board in order to ensure the heat radiation.
 注意 放熱性を確保する為に、PKGの裏面放熱板(ヒートシンク)を基板に半田付けする事を推奨いたします。

Stencil Opening

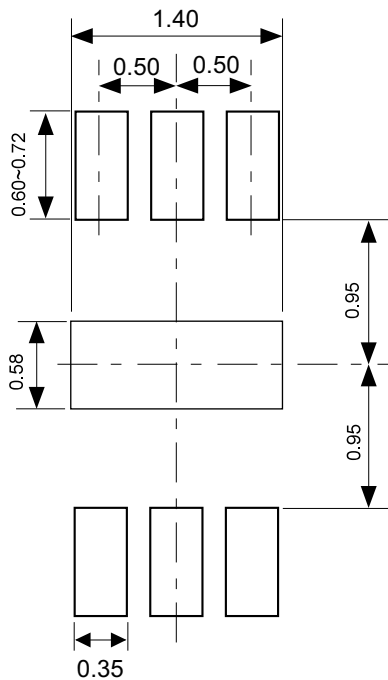

No. PJ006-B-LM-SD-1.0

Caution ① Mask aperture ratio of the lead mounting part is 100~120%.
 ② Mask aperture ratio of the heat sink mounting part is 30%.
 ③ Mask thickness: t0.12 mm
 ④ Reflow atmosphere: Nitrogen atmosphere is recommended.
 (Oxygen concentration: 1000ppm or less)

注意 ①リード実装部のマスク開口率は100~120%です。
 ②放熱板実装のマスク開口率は30%です。
 ③マスク厚み : t0.12 mm
 ④リフロー雰囲気・窒素雰囲気(酸素濃度1000ppm以下) 推奨

TITLE	HSNT-6-C -Land & Stencil Opening
No.	PJ006-B-LM-SD-1.0
ANGLE	
UNIT	mm
ABLIC Inc.	

Disclaimers (Handling Precautions)

1. All the information described herein (product data, specifications, figures, tables, programs, algorithms and application circuit examples, etc.) is current as of publishing date of this document and is subject to change without notice.
2. The circuit examples and the usages described herein are for reference only, and do not guarantee the success of any specific mass-production design.
ABLIC Inc. is not liable for any losses, damages, claims or demands caused by the reasons other than the products described herein (hereinafter "the products") or infringement of third-party intellectual property right and any other right due to the use of the information described herein.
3. ABLIC Inc. is not liable for any losses, damages, claims or demands caused by the incorrect information described herein.
4. Be careful to use the products within their ranges described herein. Pay special attention for use to the absolute maximum ratings, operation voltage range and electrical characteristics, etc.
ABLIC Inc. is not liable for any losses, damages, claims or demands caused by failures and / or accidents, etc. due to the use of the products outside their specified ranges.
5. Before using the products, confirm their applications, and the laws and regulations of the region or country where they are used and verify suitability, safety and other factors for the intended use.
6. When exporting the products, comply with the Foreign Exchange and Foreign Trade Act and all other export-related laws, and follow the required procedures.
7. The products are strictly prohibited from using, providing or exporting for the purposes of the development of weapons of mass destruction or military use. ABLIC Inc. is not liable for any losses, damages, claims or demands caused by any provision or export to the person or entity who intends to develop, manufacture, use or store nuclear, biological or chemical weapons or missiles, or use any other military purposes.
8. The products are not designed to be used as part of any device or equipment that may affect the human body, human life, or assets (such as medical equipment, disaster prevention systems, security systems, combustion control systems, infrastructure control systems, vehicle equipment, traffic systems, in-vehicle equipment, aviation equipment, aerospace equipment, and nuclear-related equipment), excluding when specified for in-vehicle use or other uses by ABLIC, Inc. Do not apply the products to the above listed devices and equipments.
ABLIC Inc. is not liable for any losses, damages, claims or demands caused by unauthorized or unspecified use of the products.
9. In general, semiconductor products may fail or malfunction with some probability. The user of the products should therefore take responsibility to give thorough consideration to safety design including redundancy, fire spread prevention measures, and malfunction prevention to prevent accidents causing injury or death, fires and social damage, etc. that may ensue from the products' failure or malfunction.
The entire system in which the products are used must be sufficiently evaluated and judged whether the products are allowed to apply for the system on customer's own responsibility.
10. The products are not designed to be radiation-proof. The necessary radiation measures should be taken in the product design by the customer depending on the intended use.
11. The products do not affect human health under normal use. However, they contain chemical substances and heavy metals and should therefore not be put in the mouth. The fracture surfaces of wafers and chips may be sharp. Be careful when handling these with the bare hands to prevent injuries, etc.
12. When disposing of the products, comply with the laws and ordinances of the country or region where they are used.
13. The information described herein contains copyright information and know-how of ABLIC Inc. The information described herein does not convey any license under any intellectual property rights or any other rights belonging to ABLIC Inc. or a third party. Reproduction or copying of the information from this document or any part of this document described herein for the purpose of disclosing it to a third-party is strictly prohibited without the express permission of ABLIC Inc.
14. For more details on the information described herein or any other questions, please contact ABLIC Inc.'s sales representative.
15. This Disclaimers have been delivered in a text using the Japanese language, which text, despite any translations into the English language and the Chinese language, shall be controlling.

2.4-2019.07