



Plug-in Detector for Type-C Connector

Pin Descriptions

Pin Number	Pin Name	I/O	Description
1	CC1	I/O	Type-C Configuration channel signal
2	CC2	I/O	Type-C Configuration channel signal
3	PORT	I	Tri-level input pin to indicate port mode (see functional description): PORT is floating – Dual role (DRP); PORT=VDD – Host (SRC); PORT=GND – Device (SNK)
4	VBUSDET	I	4V to 28V VBUS input voltage. VBUS detection determines Device attachment. One 910kΩ external resistor required between system VBUS and VBUSDET pin
5	ADDR	I	Tri-level input pin to indicate I ² C address or pin control mode: ADDR is floating – Pin control mode; ADDR=VDD – I ² C enabled with ADDR bit 6 equal to 1; ADDR=GND – I ² C enabled with ADDR bit 6 equal to 0
6	INTB / OUT3	O	Open drain output. In I ² C control mode, this is an active LOW interrupt signal for indicating changes in I ² C registers. Dual function as audio adapter accessory detection in pin control mode: OUT3=Hi-Z – Not detected OUT3=Low – Audio-adapter accessory detected
7	SDA / OUT1	I/O	I ² C communication data signal. Dual function as open drain Type-C Current Mode Detect 1 in pin control mode when port is a device: <u>OUT2 OUT1 Current Mode</u> Hi-Z Hi-Z Default Hi-Z Low Medium Low Low High
8	SCL / OUT2	I/O	I ² C communication clock signal. Dual function as open drain Type-C Current Mode Detect 2 in pin control mode when port is a device: <u>OUT2 OUT1 Current Mode</u> Hi-Z Hi-Z Default Hi-Z Low Medium Low Low High
9	ID	O	Open drain output. Asserted low when CC pin detected device attachment when port is a Host (or dual-role acting as Host), otherwise ID is hi-z.
10	GND	Ground	Ground
11	ENB	I	Active-low enable input pin (with internal weak pull up) ENB=VDD – Disabled/Low Power State ENB=GND – Enabled/Active State
12	VDD	Power	Positive supply voltage from VBAT

Application Circuit PI5USB30216A

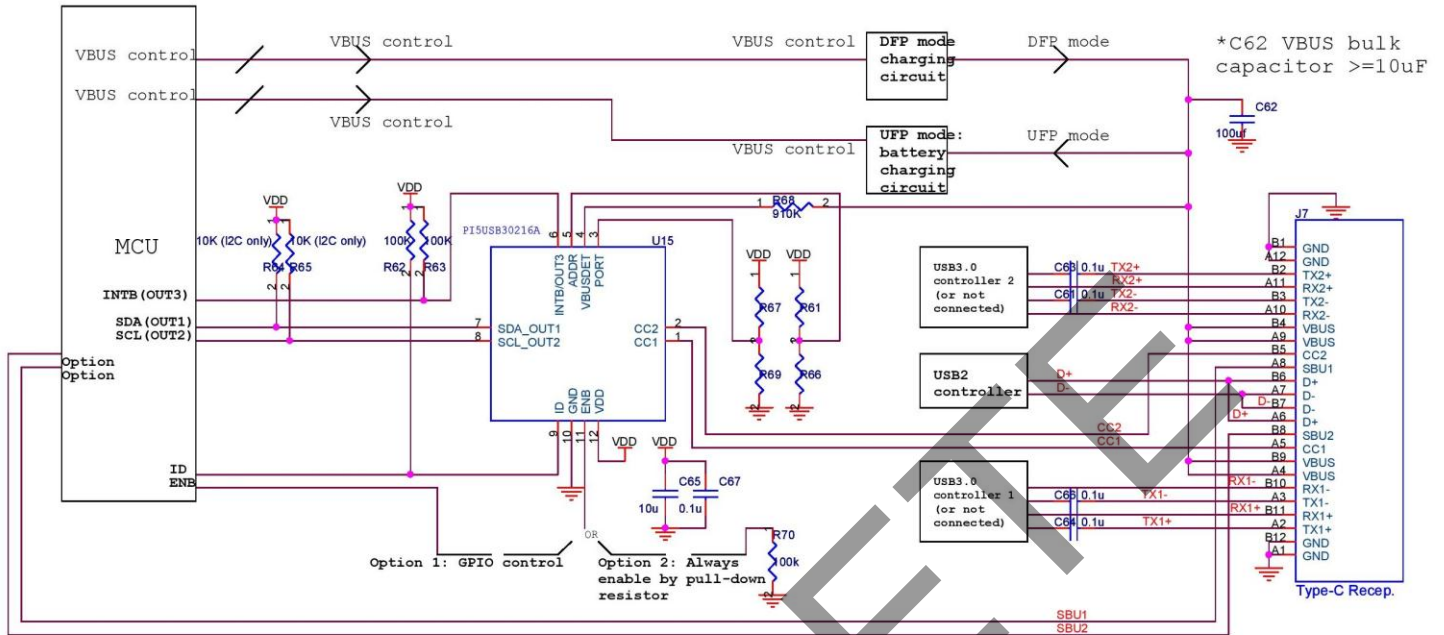

Type-C port mode	R67	R69
UFP/Sink/Device	NC	4.7K
DFP/Source/Host	4.7K	NC
DRP	NC	NC

	C62
VBUS bulk capacitor	>=10uF

Control mode	R61	R66
I2C mode address: 7-bit addressing: 0x1D or 8-bit write address: 0x3A 8-bit read address: 0x3B	NC	4.7K
I2C mode address: 7-bit addressing: 0x3D or 8-bit write address: 0x7A 8-bit read address: 0x7B	4.7K	NC
Pin Control Mode	NC	NC

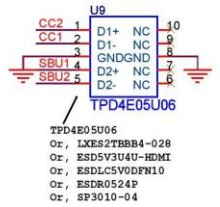

OBSOLETE



Maximum Ratings

Storage Temperature.....	-65°C to +150°C
Supply Voltage from Battery/Baseband.....	-0.5V to +6.0V
ID Pin Sink current.....	10mA
ESD: HBM all pins.....	2000V

Note:

Stresses greater than those listed under MAXIMUM RATINGS may cause permanent damage to the device. This is a stress rating only and functional operation of the device at these or any other conditions above those indicated in the operational sections of this specification is not implied. Exposure to absolute maximum rating conditions for extended periods may affect reliability.

Recommended operation conditions

Symbol	Parameter	Min.	Max.	Units
V _{DD}	Battery Supply Voltage	2.7	5.5	V
V _{BUS}	System VBUS Voltage	4	28	V
V _{BAT TH}	Battery Supply Under-Voltage Lockout Threshold	2.2	2.6	V
V _{IH}	High level input voltage (ENB, SCL, SDA)	1.05	-	V
V _{IL}	Low level input voltage (ENB, SCL, SDA)	-	0.4	V
V _{3IH}	High level input voltage (ADDR, PORT)	V _{DD} -0.4	-	V
V _{3IL}	Low level input voltage (ADDR, PORT)	-	0.4	V
V _{VBUSDET}	VBUSDET input voltage ⁽¹⁾	-	4.5V	V
V _{TYPEC CC}	CC1, CC2 input voltage ⁽²⁾	-	V _{DD} +0.5	V
T _A	Operating Temperature	-40	85	°C

(1) V_{VBUSDET} pin is internally clamp to ~5.5V.

(2) CC1, CC2 pins are internally clamp to ~V_{DD}+1.0V.

DC Electrical Characteristics

Min and Max apply for T_A between -40°C to 85°C and T_J up to +125°C (unless otherwise noted).

Typical values are referenced to V_{DD}=3.6V, T_A=+25°C

Symbol	Parameter	Test Conditions	Min.	Typ.	Max.	Units
CC1/CC2 Configuration(Device mode, SNK)						
R _d	Device mode pull-down resistor		4.6	5.1	5.6	kΩ
V _{TH3 SNK}	High current mode entry threshold		1.16	1.23	1.31	V
V _{TH2 SNK}	Medium current mode entry threshold		0.61	0.66	0.70	V
V _{TH1 SNK}	Default current mode entry threshold		0.15	0.2	0.25	V
CC1/CC2 Configuration(Host mode, SRC)						
I _p	Host mode pull up current source	Default current mode	64	80	96	μA
		Medium current mode (1.5A)	166	180	194	
		High current mode (3A)	304	330	356	
VBUS Detection						
V _{VBUS}	VBUS detection threshold	R _{VBUS} =910kohm	2.5	3.0	4.0	V
R _{VBUS}	External resistor between VBUS and VBUSDET pin		865	910	955	kΩ
Host Interface Pins (INTB, ID, OUT1, OUT2, OUT3)						
V _{OL}	Output Low Voltage at 1.6 mA Sink current(Open-Drain)		0	-	0.4	V
I _{OFF}	Off-state leakage current	V _{INTB.ID/ID/OUT1/OUT2/OUT3}	-	-	1	μA
Input Control Pins (ENB, ADDR, PORT, SCL, SDA)						
I _{IH}	High-level input current		-5	-	5	μA
I _{IL}	Low-level input current		-5	-	5	μA
R _{IENB}	Internal pull-up resistance for ENB		-	5	-	MΩ
Current Consumption						
I _{DD}	Operating current, Device mode	SNK connects to SRC	-	35	55	μA
	Operating current, Host mode	SRC connects to SNK Default current mode	-	135	180	μA
I _{DISABLE}	Chip is disabled	ENB=V _{DD}	-	-	5	μA
I _{DEV_STBY}	Device mode standby current	V _{DD} =3.6V, Floating CC1 and CC2	-	35	55	μA
I _{DUAL_STBY}	Dual-Role mode standby current	V _{DD} =3.6V, Floating CC1 and CC2	-	45	65	μA
I _{HOST_STBY}	Host mode standby current	V _{DD} =3.6V, Floating CC1 and CC2	-	55	75	μA

Detailed Description using I2C Control

ADDR

ADDR is a tri-level input pin to indicate I2C or pin control (or GPIO) mode. When ADDR pin is floating, the part is set to pin control mode. When ADDR is set to VDD or GND, I2C mode is enabled, and bit 6 of I2C address is equal to 1 or 0 according to ADDR set to VDD or GND (see Table 2: I2C Slave Address).

Configuration

The PI5USB30216A requires minimal configuration for proper detection and reporting. Write register 0x02 (Control Register) to configure different charging profiles and port settings.

Processor Communication

Typical communication steps between the processor and the PI5USB30216A during plug detection are:

1. INTB asserted LOW, indicating changes in register 0x03 (Interrupt Register) or register 0x04 (CC Status Register).
2. Processor reads Interrupt registers to determine which event occurred. Interrupt Register (0x03) indicates if an attach or detach event was detected. All interrupt flags in Interrupt Register (0x03) will be cleared after the I²C read action. INTB will become hi-z again after the clearance of interrupt flags.
3. Processor reads CC Status Register (0x04) to determine plugin details and charging profile. Processor can configure the power and USB channels according to information in CC Status Register (0x04).

Interrupts

The baseband processor recognizes interrupt signals by observing the INTB signal, which is active LOW. Interrupts are masked upon bit 0 of Control Register 0x02 (Interrupt Mask Bit). After the Interrupt Mask Bit is cleared by the baseband processor, the INTB pin is hi-z in preparation for a future interrupt. When an interruptible event occurs, INTB pin transits to LOW and returns hi-z when the processor reads the Interrupt Register (0x03). Subsequent to the initial power up or reset; if the processor writes a “1” to Interrupt Mask Bit (bit 0 of Control Register 0x02) when the system is already powered up, INTB pin stays hi-z and ignores all interrupts until the interrupt mask bit is cleared.

Besides monitoring the I²C registers, the system can also monitor ID pin and VBUS for connector status. If the port is configured as a device (or dual-role acting as device), VBUS will go to 5V when host attachment is detected. If the port is configured as a host (or dual-role acting as host), ID pin will pull low when device attachment is detected, and system should assert VBUS.

Port Setting (Host/Device/Dual-Role)

When power is applied to VDD, an internal Power-On Reset (POR) holds the PI5USB30216A in a reset condition until VDD has reached 2.6V. At that point, the reset condition is released and the PI5USB30216A registers and I²C-bus state machine will initialize to their default states. Bits [2:1] of Control Register (0x02) are initialized according to the PORT pin setting (see Table 3 I²C Register). PI5USB30216A can be configured as host, device or dual-role port per the register. After power up, the port setting can still be changed by I2C writes to [2:1] of Control Register (0x02). Thereafter, VDD must be lowered below 1.0V to reset the device (both registers and I²C-bus state machine).

PI5USB30216A connects current sources to CC1 and CC2 when operating in host mode. It will also set the current level according to the charging current setting. In device mode, PI5USB30216A will connect two integrated resistor Rd1 and Rd2 to CC1 and CC2 respectively. Dual-Role mode enables CC1 and CC2 toggle between host mode and device mode alternatively every 60ms. The toggling will stop after connection is made and role negotiated.

Current Mode Setting and Detection

PI5USB30216A can be configured as different current modes per CC1/CC2 setting. Host mode (or dual role acting as Host) allows the system to configure between High Current Mode (3A), Medium Current Mode (1.5A) and Default Current Mode. Different current modes can be set by writing Control Register (0x02). When in Device mode (or dual role acting as device), CC1/CC2 pins allow the system to detect the host charging capability. The charging capability is reported in CC Status Register (0x04) which can help the system to configure the charging current accordingly.

ID

When PI5USB30216A is configured as host mode (or dual role acting as host), ID pin will be pulled low when a device is attached to the type-C connector. The ID pin will work as an interrupt signal to acknowledge system when there is device attachment. It should be noted the ID pin will not be driven low when an audio or debug accessory is detected, and ID pin will always stay Hi-Z when port is in device mode.

Audio Adapter Accessory and Debug Accessory Mode

PI5USB30216A can detect audio adapter accessory or debug accessory attachment as per CC1/CC2 setting. This is reported in CC Status Register (0x04) to help system to configure Audio Adapter Accessory Mode or Debug Accessory Mode accordingly.



VBUS Detection

PI5USB30216A detects VBUS to determine the attached state when port is a device. A 910kohm +/- 5% is required to connect VBUS of the connector to VBUSDET input pin to protect the IC from the possible high voltage of VBUS during alternative mode.

ENB

ENB is an active low enable input pin. When ENB pin is high, part is in disable and low power state. All outputs, with the exception of CC1 and CC2 are in High-Z state. CC1 and CC2 pins are pulled low with resistors Rd in disable state. I²C port will also be reset during disable state.

Dead Battery Startup

PI5USB30216A ensures dead battery charging when VDD=0V. Both CC1 and CC2 will be pulled down when VDD=0V. Such configuration helps other host port detect the dead battery port as a device mode port and enable charging through VBUS.

OBSOLETE

Pin Control Functional Description

Type-C Connector Port Setting (PORT)

PI5USB30216A can be configured as different ports by changing PORT pin voltage level.

Table 1A. Port Setting

Port setting	PORT
Device (SNK)	GND
Dual-role port (DRP)	No Connection
Host (SRC)	VDD

Type-C Connector Current Mode Detection (OUT1, OUT2)

PI5USB30216A can detect different host current modes and other accessories per CC1/CC2 setting. When PI5USB30216A operates in device mode (or dual role mode acting as device), it detects CC1/CC2 status to determine host charging current modes and reports to the system using OUT1 and OUT2 pins. OUT1 and OUT2 will always stay hi-z unless medium or high current mode is detected.

Table 1B. Current Mode Detection

	OUT2	OUT1
Default current mode	Hi-Z	Hi-Z
Medium current mode (1.5A)	Hi-Z	Low
High current mode (3A)	Low	Low

Type-C Connector Current Mode Setting in Host Mode

When PI5USB30216A is configured as a host, it can only be set to Default Current Mode (current source $I_p=80\mu A$). I2C control is required to set current mode to 1.5A or 3A.

Audio Adapter Accessory Detection (OUT3)

PI5USB30216A detects audio adapter accessory attachment as per CC1/CC2 setting. This is reported by the OUT3 pin. OUT3 will be pulled low when an audio adapter accessory attachment is detected. Otherwise, OUT3 is hi-z.

Table 1C. Audio Adapter Accessory Detection

Audio Adapter Accessory	OUT3
Detected	Low
Not Detected	Hi-Z

ADDR, ID, ENB, and Dead Battery Startup

Functionality of the ADDR, ID, and ENB pins are the same for pin control or I2C control modes. Dead battery startup operation is also the same for pin control and I2C control modes. Please refer to previous section for detail description.

I²C AC Electrical Characteristics

Symbol	Parameter	Fast Mode (400kHz)		Units
		Min.	Max.	
f _{SCL}	SCL Clock Frequency	0	400	kHz
t _{HD:STA}	Hold Time (Repeated) START Condition	0.6	-	μs
t _{LOW}	LOW Period of SCL Clock	1.3	-	μs
t _{HIGH}	HIGH Period of SCL Clock	0.6	-	μs
t _{SETSTA}	Set-up Time for Repeated START Condition	0.6	-	μs
t _{HDDAT}	Data Hold Time	0	0.9	μs
t _{SETDAT}	Data Set-up Time ⁽¹⁾	250	-	ns
t _r	Rise Time of SDA and SCL Signals ⁽²⁾		300	ns
t _f	Fall Time of SDA and SCL Signals ⁽²⁾		300	
t _{SETSTO}	Set-up Time for STOP Condition	0.6	-	μs
t _{BUF}	Bus-Free Time between STOP and START Conditions	1.3	-	μs
t _{SP}	Pulse Width of Spikes that Must Be Suppressed by the Input Filter	0	50	ns

Notes:

1. A fast-mode I²C-bus device can be used in a standard-mode I²C-bus system, but the requirement t_{SETDAT} ≥ 250ns must be met. This is automatically the case if the device does not stretch the LOW period of the SCL signal. If such a device does stretch the LOW period of the SCL signal, it must output the next data bit to the SDA line t_{r_max} + t_{SETDAT} = 1000 + 250 = 1250ns (according to the standard-mode I²C bus specification) before the SCL line is released.
2. C_b equals the total capacitance of one BUS line in pF. If mixed with high-speed devices, faster fall times are allowed according to the I²C specification.

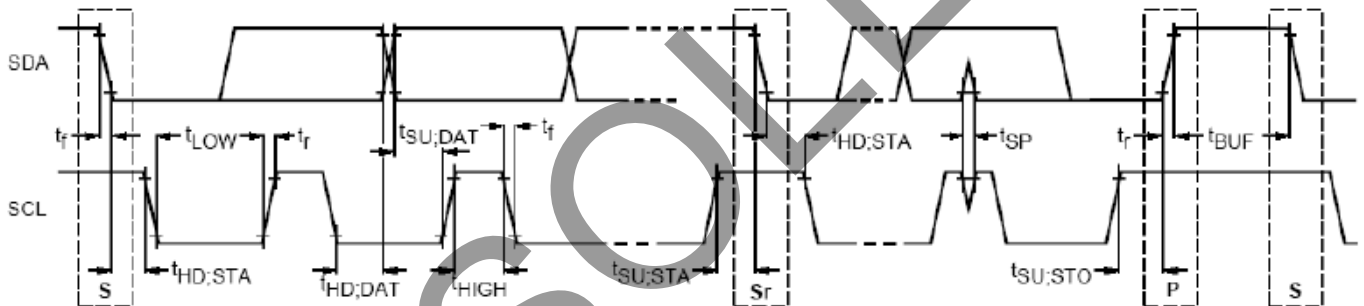

Figure 3. Definition of Timing for Full-Speed Mode Devices on the I²C Bus

Table 2. I²C Slave Address

Name	Size (Bits)	Bit 7	Bit 6	Bit 5	Bit 4	Bit 3	Bit 2	Bit 1	Bit 0
Slave Address(ADDR=1)	8	0	1	1	1	1	0	1	R/W
Slave Address(ADDR=0)		0	0	1	1	1	0	1	R/W

I²C Data Transfer

1. Read Sequence

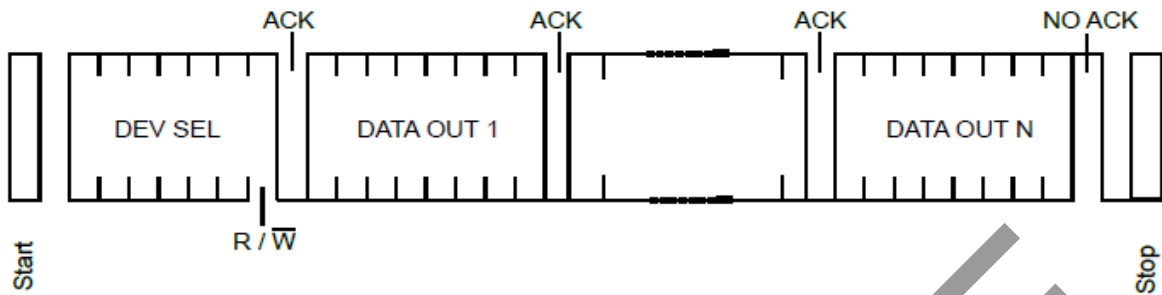

2. Write Sequence

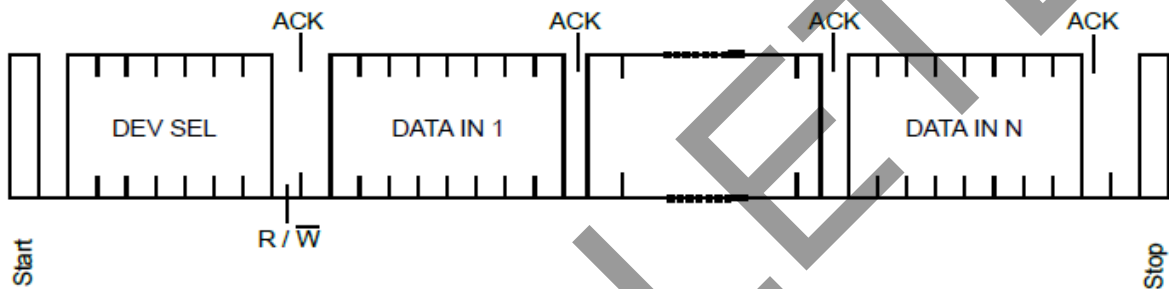

Note:

1. PI5USB30216A does not have offset byte. All registers must be read or written sequentially from 0x00. For example, in order to read address 0x04, PI5USB30216A I2C registers must be read sequentially from 0x01, 0x02, 0x03 to 0x04. In order to write address 0x02, it must be written sequentially from 0x01 to 0x02.

Table 3. I²C Register

Address	Name	Description	Default Value	Type								
0x01	Device ID	<p>Bits [7:3] = Version ID</p> <p>00h = Product version</p> <p>Bits [2:0] = Vendor ID(Pericom)</p> <p>00h = Pericom</p>	00h	R								
0x02	Control	<p>Bit 7 = Powersaving</p> <p>0 = Enable/Active state 1 = Disable and low power state</p> <p>In Disable and low power state, all outputs of PI5USB30216A, with the exception of CC1 and CC2 pins, are in High-Z State. CC1 and CC2 pins are pulled low with resistor Rd.</p> <p>Bits [6] = Reserved. Do not change.</p> <p>Bits [5] = Accessory Detection in Device Mode</p> <p>0 = Disable 1 = Enable</p> <p>Bits [4:3] = Charging current mode</p> <p>System can set the charging current mode when port is a host or dual role acting as host. These bits are ignored when port is a device or dual role acting as device.</p> <p>00 = Default current mode 01 = Medium current mode (1.5A) 10 = High current mode (3A)</p> <p>Bits [2:1] = Port setting</p> <p>System can set the role of the port.</p> <p>00 = Device (SNK) 01 = Host (SRC) 10 = Dual Role (DRP)</p> <p>Bit 0 = Interrupt Mask</p> <p>INTB pin is used to acknowledge system if there is any interrupt events triggered. When this bit is set to 0, INTB pin is pulled low when an interrupt event occur. When this bit is set to 1, INTB pin ignores all interrupt and remain High-Z.</p> <p>0 = Do not mask interrupt 1 = Mask interrupt</p>	<p>00h</p> <p>Upon power-up, Bits [2:1] are initialized according to PORT pin setting as follows:</p> <table border="1" data-bbox="1136 696 1318 896"> <thead> <tr> <th>PORT pin initial settings</th> <th>Bits [2:1]</th> </tr> </thead> <tbody> <tr> <td>GND</td> <td>00</td> </tr> <tr> <td>VDD</td> <td>01</td> </tr> <tr> <td>Float</td> <td>10</td> </tr> </tbody> </table> <p>Note: This initialization only happens once when PI5USB30216A is powered up. Bits [2:1] can be changed by I²C command afterwards.</p>	PORT pin initial settings	Bits [2:1]	GND	00	VDD	01	Float	10	R/W
PORT pin initial settings	Bits [2:1]											
GND	00											
VDD	01											
Float	10											
0x03	Interrupt	<p>Bits [7:2] = Reserved. Read all 0's.</p> <p>Bit 1 = Detach event</p> <p>When this bit is set to 1, it indicates the unplug action. The port changes from attached state (Attached.SNK, Attached.SRC, AudioAccessory or DebugAccessory state) to unattached state.</p> <p>Bit 0 = Attach event</p> <p>When this bit is set to 1, it indicates the plug action. The port changes from unattached state to attached state.</p>	00h	Clearable read only. Bits[1:0] are cleared when Byte 3 is read.								



Address	Name	Description	Default Value	Type
0x04	CC status	<p>Bit 7 = VBUS detection This bit reports VBUS status when PI5USB30216A is in device mode, dual role mode acting as device or accessory mode.</p> <p>0 = VBUS not detected 1 = VBUS detected</p> <p>Bits [6:5] = Charging current detection These bits report the detected host charging current status when port is a device or dual role acting as device.</p> <p>00 = Standby 01 = Default current mode 10 = Medium current mode (1.5A) 11 = High current mode (3A)</p> <p>Bits [4:2] = Attached port status</p> <p>000 = Standby 001 = Device 010 = Host 011 = Audio Adapter Accessory 100 = Debug Accessory</p> <p>Bits [1:0] = Plug polarity</p> <p>00 = Standby 01 = CC1 makes connection 10 = CC2 makes connection 11 = Undetermined (e.g. AudioAccessory, DebugAccessory or other undetermined connections)</p>	00h	R

OBSOLETE

Table 3. I2C Register Table

Address	Register	Type	Reset Value	Bit 7	Bit 6	Bit 5	Bit 4	Bit 3	Bit 2	Bit 1	Bit 0
01H	Device ID	Read	00000000	Version ID : 00000					Vendor ID(Pericom): 000		
02H	Control	Read/Write	00000000	Powersaving	reserved	Accessory Detection in Device Mode	Charging Current mode (Port is a Host)		Port setting (see below)		Interrupt Mask
				0: No Powersaving 1: Powersaving	reserved	0: Disable 1: Enable	00: Default 01: Medium 10: High	00: Device 01: Host 10: Dual Role	0: Does not Mask Interrupts 1: Mask Interrupts		
03H	Interrupt	Read/Clear	00000000	reserved					Detach Event	Attach Event	
									0: No Interrupt 1: Change from attached to detached	1: Change from detached to attached	
04H	CC status	Read	00000000	VBUS detection (Port is a Device or in accessory mode)	Charging current detection (Port is a Device)		Attached Port Status			Plug polarity	
				0: Vbus not detected 1: Vbus detected	00: Standby 01: Default 10: Medium 11: High	000: Standby 001: Device 010: Host 011: Audio 100: Debug Accessory	00: Standby 01: CC1 connected 10: CC2 connected 11: undetermined				

Upon power-up, Bit 1 and Bit 2 of register 02H are initialized according to the pin #3 PORT setting as follows:

Pin #3 Port Initial Connection	Bit 2 & Bit 1 of Register 02H initialization
PORT pin is floating – Dual role;	10
PORT pin =VDD – Host;	01
PORT pin =GND – Device	00

This initialization only happens once when PI5USB30216A is powered up. Bit 1 and Bit 2 of register 02H can be changed by I2C commands afterwards.

Table 4. Register Table Description

Address 01H Device ID		
Feature	Vendor ID	
Bits	Bit 2 – Bit 0	
Feature Description	Indicate vendor name : 000 represents Pericom	
Feature	Version ID	
Bits	Bit 7 – Bit 3	
Feature Description	Indicate product version	

Address 02H Control		
Feature	Interrupt mask	
Bits	Bit 0	
Feature Description	INTB pin is used to acknowledge system if there is any interrupt events triggered. Interrupt mask provide the flexibility to enable the interrupt or not at INTB pin. 0 = active LOW at INTB when interrupt event occur; 1= always HIGH at INTB	
Feature	Port setting	
Bits	Bit 2 – Bit 1	
Feature Description	System can set the role of the port by programming this 2 bits 00=Device; 01=Host; 10=Dual Role	
Feature	Charging current mode for Host or Dual role acting as Host (Ignored when port is configured as Device)	
Bits	Bit 4 – Bit 3	
Feature Description	System can set the charging current of the port by programming this 2 bits 00=Default current mode; 01=Medium current mode(1.5A); 10=High current mode(3A)	
Feature	Accessory Detection in Device Mode	
Bits	Bit 5	
Feature Description	0 = Accessory Detection in Device Mode is disable; 1 = Accessory Detection in Device Mode is enable	
Feature	Powersaving	
Bits	Bit 7	
Feature Description	1 = Part is in disable and low power state. All outputs, with the exception of CC1 and CC2 are in High-Z state. CC1 and CC2 pins are pulled low with resistor Rd.	

Address 03H Interrupt		
Feature	Attach Event	
Bits	Bit 0	
Feature Description	1 = It indicates the plug action (from Detached to Attached.SNK, Attached.SRC, DebugAccessory or AudioAccessory states)	
Feature	Detach Event	
Bits	Bit 1	
Feature Description	1 = It indicates the unplug action (from Attached.SNK, Attached.SRC, DebugAccessory or AudioAccessory states to unattached state)	



Address 04H CC Status	
Feature	Plug polarity
Bits	Bit 1 - Bit 0
Feature Description	Reports the detected plug orientation 00=Standby, 01=CC1 makes connection; 10=CC2 makes connection, 11=Undetermined (e.g. AudioAccessory, DebugAccessory or other undetermined connections)
Feature	Attached Port Status
Bits	Bit 4 – Bit 2
Feature Description	PI5USB30216A reports the attached port status 000= Standby; 001= Device; 010=Host; 011=Audio ; 100=Debug Accessory
Feature	Charging current detection when port is a Device or dual role acting as device
Bits	Bit 6 – Bit 5
Feature Description	PI5USB30216A works as a SNK and reports the detected host charging current status 00=Standby; 01=Default current mode; 10=Medium current mode(1.5A); 11=High current mode(3A)
Feature	VBUS detection
Bits	Bit 7
Feature Description	Report VBUS status when PI5USB30216A is in device mode, dual role mode acting as device or accessory mode 0 = VBUS not detected; 1=VBUS detected

OBSOLETE

Connection State Diagram: SRC

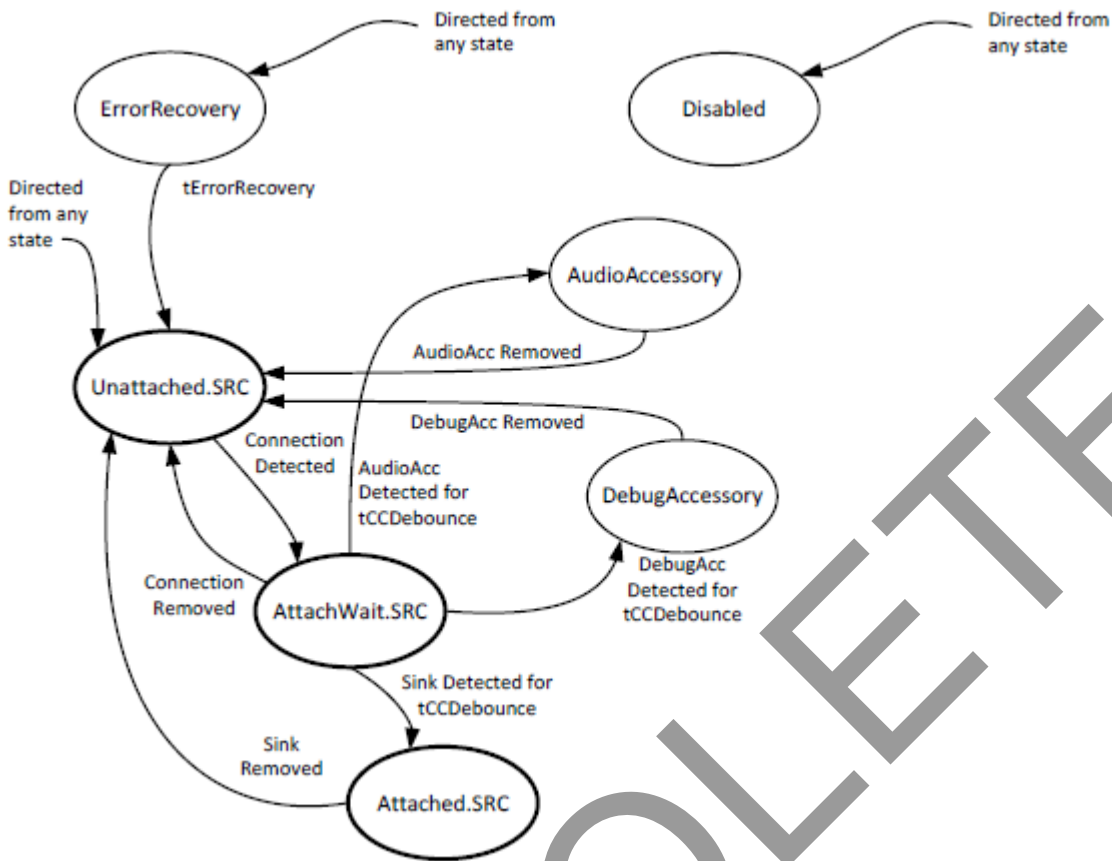

OBSOLETE

Connection State Diagram: SNK (Accessory Detection is disable)

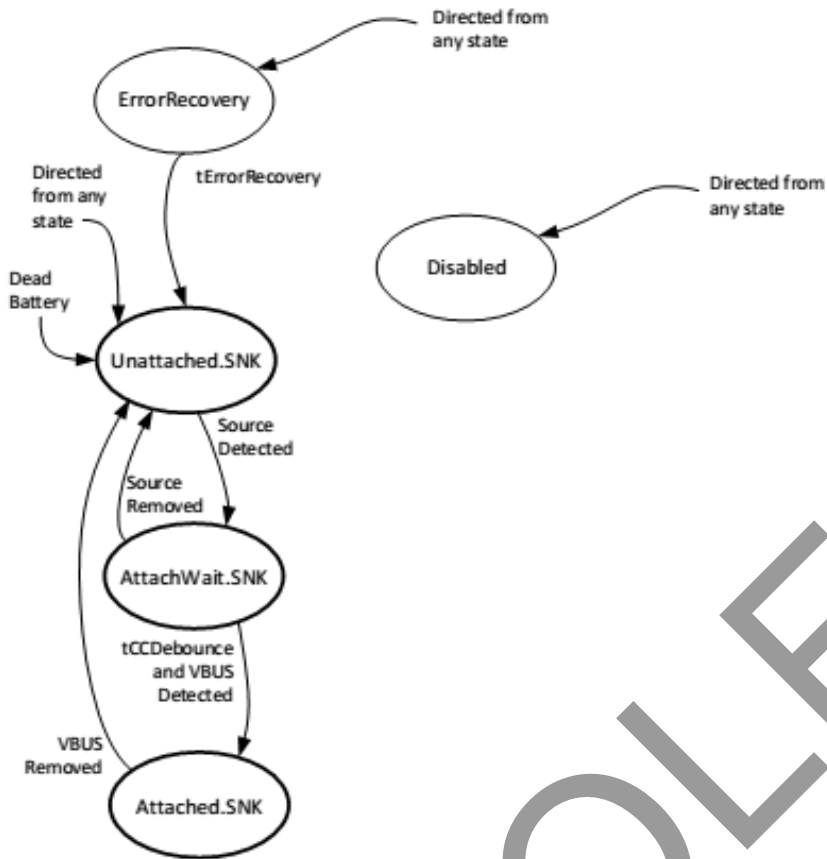

OBSOLETE

Connection State Diagram: SNK (Accessory Detection is enable)

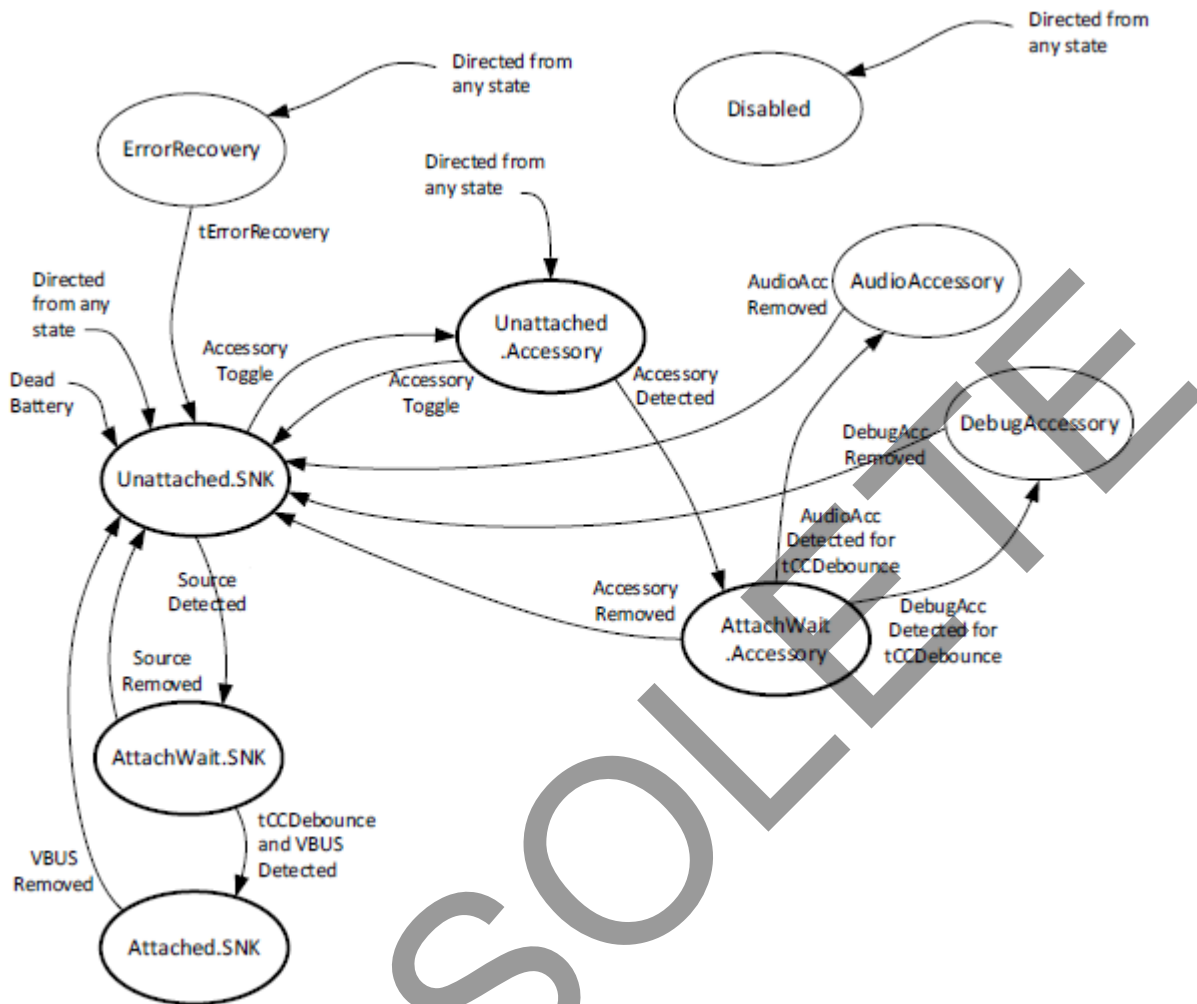

Connection State Diagram: DRP

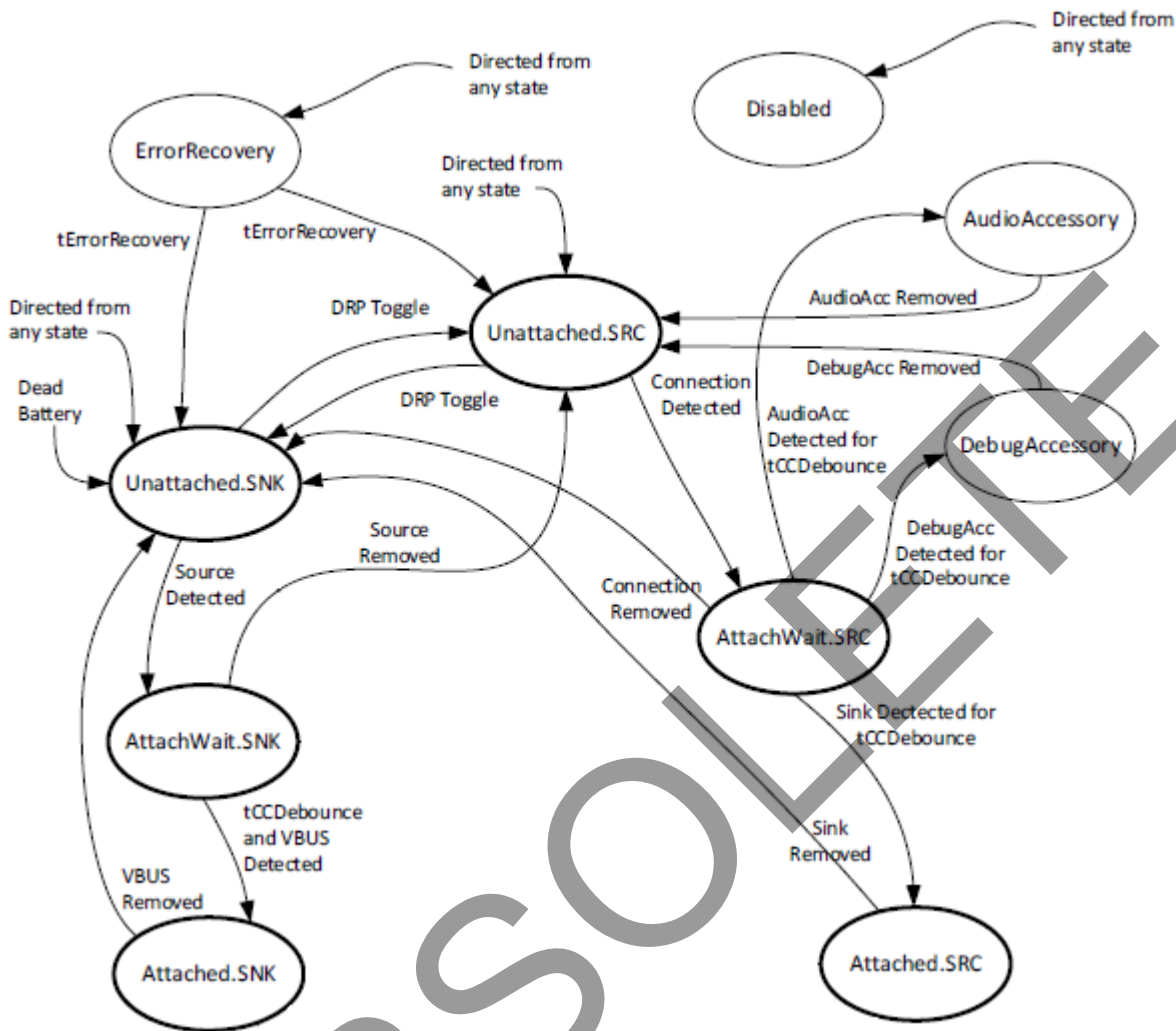

Mechanical Information

STQFN 1.6 X 1.6 -12 Contact (To Be Provided)

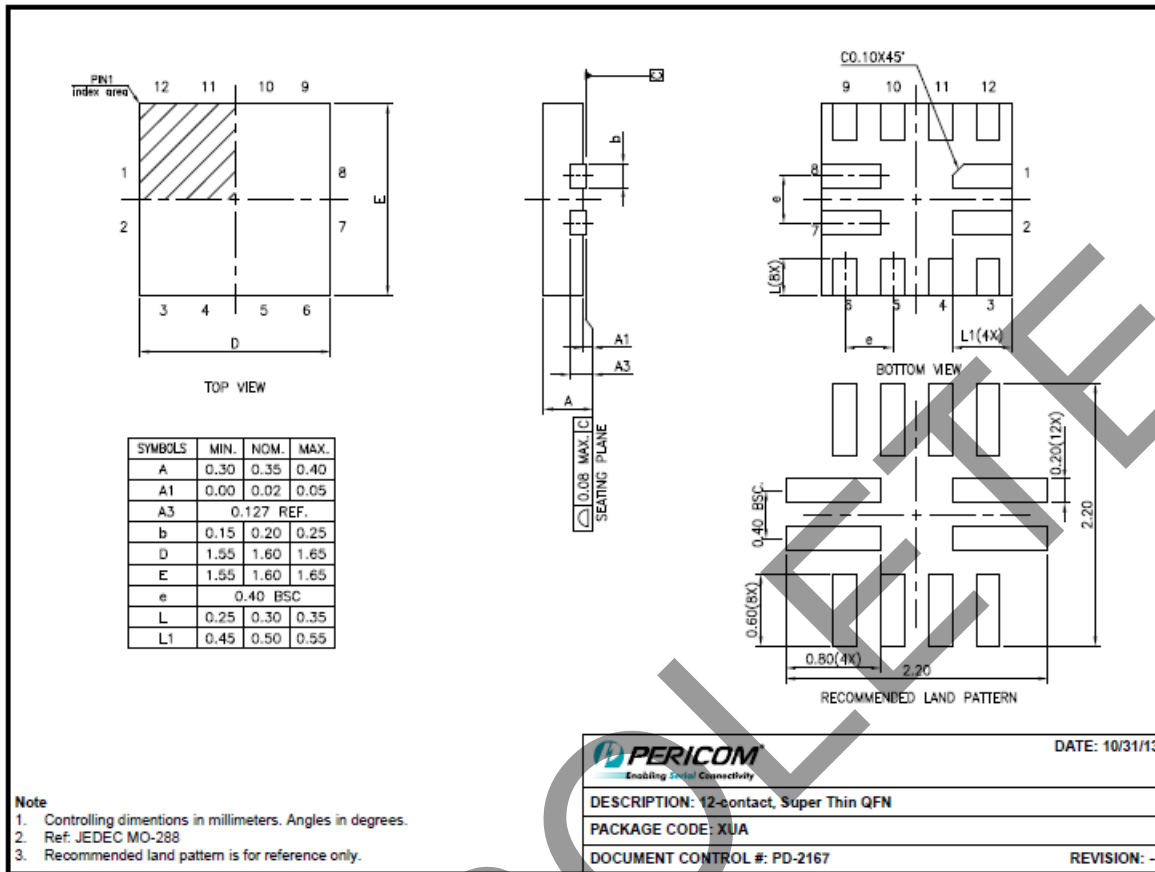

Ordering Information

Ordering Number	Package Code	Package Description
PI5USB30216AXUAE	XUA	Pb-free & Green 12-Contact STQFN
PI5USB30216AXUAEX	XUA	Pb-free & Green 12-Contact STQFN, Tape & Reel

Note:

1. Thermal characteristics can be found on the company web site at www.pericom.com/packaging/
2. E = Pb-free and Green
3. X suffix = Tape/Reel

Pericom Semiconductor Corporation • 1-800-435-2336 • www.pericom.com

Pericom reserves the right to make changes to its products or specifications at any time, without notice, in order to improve design or performance and to supply the best possible product. Pericom does not assume any responsibility for use of any circuitry described other than the circuitry embodied in Pericom product. The company makes no representations that circuitry described herein is free from patent infringement or other rights of Pericom.