

## General Description

The AP3606 and AP3607 are step-up DC-DC converters based on 1x/1.5x charge pump and low dropout current sink, which helps them maintain the highest efficiency. The AP3606 is specially designed to drive up to 4 WLEDs in backlight display while the AP3607 is designed for 6 WLEDs.

These devices provide up to 20mA current for each WLED. There are totally 16 steps of current control, which is achieved through a digital pulse dimming function on EN pin. Additionally, 1MHz high switching frequency enables the use of small external capacitors. Internal soft-start circuitry prevents excessive inrush current during start-up and mode transition.

The supply voltage ranges of AP3606 and AP3607 are from 2.7V to 5.5V which make them ideally suit for applications powered by Li-ion battery.

These ICs are available in the tiny package of QFN-3x3-16.

## Features

- Regulated Output Current with  $\pm 3\%$  Matching
- Drives up to 4 WLEDs at 20mA Each (AP3606)  
Drives up to 6 WLEDs at 20mA Each (AP3607)
- 16 Steps Brightness Control Using Pulse Signal Dimming
- Wide Operating Voltage Range: 2.7V to 5.5V
- High Operating Frequency: 1MHz
- Auto 1x/1.5x Charge Pump Mode Selection
- Built-in Soft-start
- Output Over Voltage Protection
- Built-in UVLO
- Built-in OTSD
- Operating Temperature Range:  $-40^{\circ}\text{C}$  to  $85^{\circ}\text{C}$

## Applications

- Mobile Phone
- PDA
- MP3/4

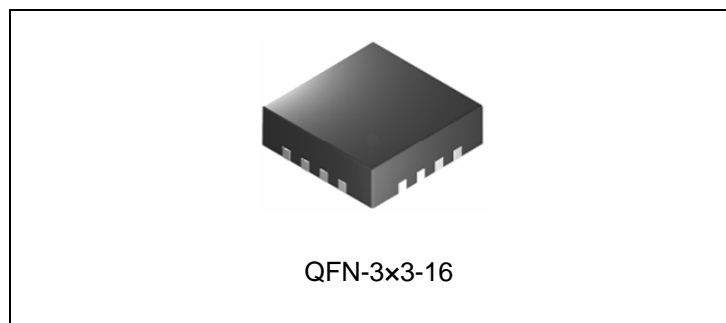
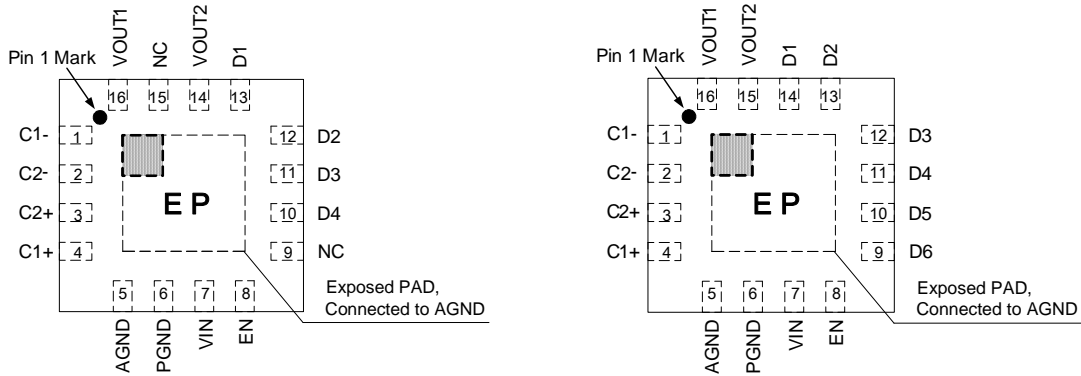

Figure 1. Package Type of AP3606/AP3607

### Pin Configuration

FN Package  
(QFN-3×3-16)



Note: Pin 14 should be connected with Pin 16 on PCB Board.

Note: Pin 15 should be connected with Pin 16 on PCB Board.

AP3606

AP3607

Figure 2. Pin Configuration of AP3606/AP3607 (Top View)

### Pin Description

Pin Number		Pin Name	Function
AP3606	AP3607		
1	1	C1-	Flying capacitor 1 negative terminal. The flying capacitor should be connected as close to this pin as possible
2	2	C2-	Flying capacitor 2 negative terminal. The flying capacitor should be connected as close to this pin as possible
3	3	C2+	Flying capacitor 2 positive terminal. The flying capacitor should be connected as close to this pin as possible
4	4	C1+	Flying capacitor 1 positive terminal. The flying capacitor should be connected as close to this pin as possible
5	5	AGND	Analog ground
6	6	PGND	Power ground
7	7	VIN	Supply voltage input
8	8	EN	Enable control input. Logic high enables the IC; while logic low forces the IC into shutdown mode. It is used for digital dimming by applying a pulse signal on it.
9, 15		NC	No connection (AP3606 only)
	9, 10	D6, D5	Current sink for WLED6 and WLED5. Connect the cathode of WLEDs to these pins. If not used, these pins must be connected with VIN (AP3607 only)
10, 11, 12, 13	11, 12, 13, 14	D4 ~ D1	Current sink for WLED4, 3, 2, 1. Connect the cathode of WLEDs to these pins. If not used, these pins must be connected with VIN
14	15	VOUT2	Output pin 2. It powers 4 channels current sink (AP3606) and 6 channels current sink (AP3607)
16	16	VOUT1	Output Pin 1. It's the charge pump output. The output capacitor should be placed closely to this pin

### Functional Block Diagram

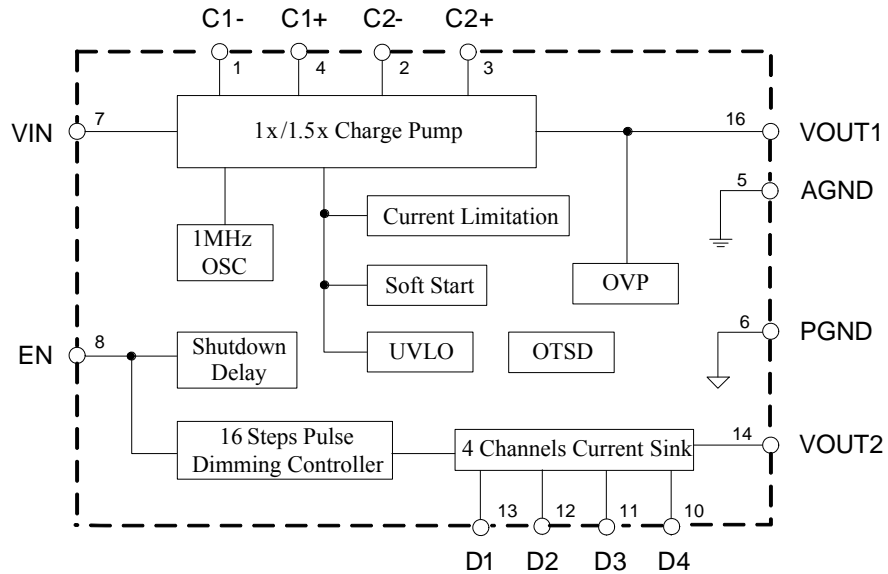

AP3606

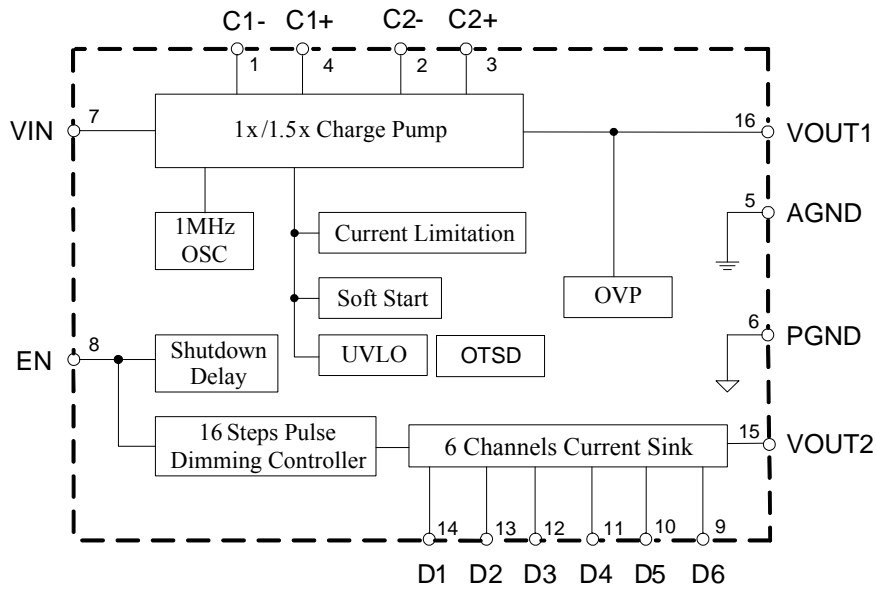

AP3607

Figure 3. Functional Block Diagram of AP3606/AP3607

### Ordering Information

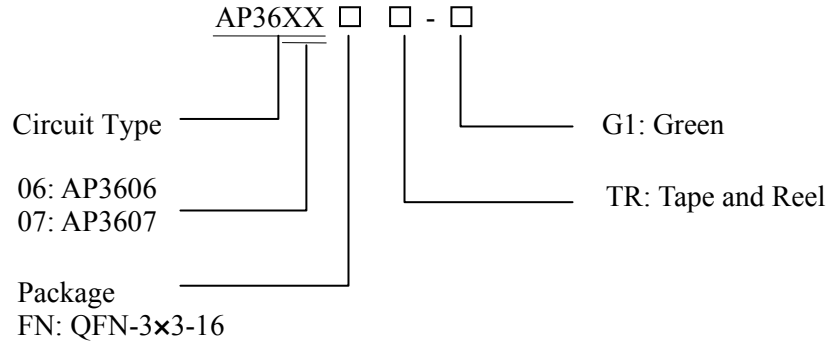

Package	Temperature Range	Part Number	Marking ID	Packing Type
QFN-3x3-16	-40 to 85°C	AP3606FNTR-G1	B1B	Tape & Reel
		AP3607FNTR-G1	B1C	

BCD Semiconductor's Pb-free products, as designated with "G1" suffix in the part number, are RoHS compliant and green.

### Absolute Maximum Ratings (Note 1)

Parameter	Symbol	Value	Unit
Input Voltage	$V_{IN}$	-0.3 to 6	V
VOUT Pin Voltage (VOUT1 & VOUT2)	$V_{OUT}$	-6 to 0.3	V
EN Pin Voltage	$V_{EN}$	-0.3 to 6	V
C1+, C2+ Pin Voltage	$V_{C+}$	-0.3 to 6	V
C1-, C2- Pin Voltage	$V_{C-}$	-6 to 0.3	V
D1, D2, D3, D4 Pin Voltage	$V_D$	$V_{OUT}$ to $V_{IN}$	V
D1, D2, D3, D4, D5, D6 Pin Voltage			
Thermal Resistance (Junction to Ambient, No Heat Sink, Free Air)	$\theta_{JA}$	60	°C/W
Operating Junction Temperature	$T_J$	150	°C
Storage Temperature	$T_{STG}$	-65 to 150	°C
Lead Temperature (Soldering, 10sec)	$T_{LEAD}$	260	°C

Note 1: Stresses greater than those listed under “Absolute Maximum Ratings” may cause permanent damage to the device. These are stress ratings only, and functional operation of the device at these or any other conditions beyond those indicated under “Recommended Operating Conditions” is not implied. Exposure to “Absolute Maximum Ratings” for extended periods may affect device reliability.



## Recommended Operating Conditions

Parameter	Symbol	Min	Max	Unit
Input Voltage	$V_{IN}$	2.7	5.5	V
Operating Ambient Temperature	$T_A$	-40	85	°C

## Electrical Characteristics

$V_{IN}=3.6V$ ,  $V_{EN}=V_{IN}$ ,  $T_A=25^{\circ}C$ ,  $C_{IN}=C1=C2=C_{OUT}=1\mu F$ ,  $V_F$ (forward voltage)=3.2V, unless otherwise noted.

Parameter	Symbol	Conditions	Min	Typ	Max	Unit	
<b>Input Section</b>							
Input Voltage	$V_{IN}$	$I_D=0mA$ to 80mA	2.7		5.5	V	
Under Voltage Lockout Threshold		$V_{IN}$ Falling		2.2		V	
Under Voltage Lockout Hysteresis				250		mV	
Supply Current	$I_{CC}$	No Load		1.7	3	mA	
Shutdown Supply Current	$I_{SHDN}$	$V_{EN}=GND$		3	10	$\mu A$	
<b>Charge Pump Section</b>							
Switch Frequency	$f_{OSC}$	$V_{IN}=3.0V$ , 1.5x Mode	0.7	1	1.3	MHz	
1x Mode to 1.5x Mode Transition Voltage ( $V_{IN}$ Falling)	$V_{1.5X}$	AP3606	$V_D=3.2V$ , $I_{D1}=I_{D2}=I_{D3}=I_{D4}=20mA$		3.5	3.6	V
		AP3607	$V_D=3.2V$ , $I_{D1}=I_{D2}=I_{D3}=I_{D4}=$ $I_{D5}=I_{D6}=20mA$				
1.5x Mode to 1x Mode Transition Voltage ( $V_{IN}$ Rising)	$V_{1X}$	AP3606	$V_D=3.2V$ , $I_{D1}=I_{D2}=I_{D3}=I_{D4}=20mA$		3.7	3.8	V
		AP3607	$V_D=3.2V$ , $I_{D1}=I_{D2}=I_{D3}=I_{D4}=$ $I_{D5}=I_{D6}=20mA$				
<b>Current Source Section</b>							
WLED Current	$I_D$	100% Setting, $3.0V \leq V_{IN} \leq 5.0V$ $T_A=-40^{\circ}C$ to $85^{\circ}C$	18.5	20	21.5	mA	



### Electrical Characteristics (Continued)

$V_{IN}=3.6V$ ,  $V_{EN}=V_{IN}$ ,  $T_A=25^{\circ}C$ ,  $C_{IN}=C1=C2=C_{OUT}=1\mu F$ ,  $V_F$ (forward voltage)=3.2V, unless otherwise noted.

Parameter	Symbol	Conditions		Min	Typ	Max	Unit
Current Matching Between any Two Outputs	$I_{D-Match1}$	AP3606	$V_{D1}=V_{D2}=V_{D3}=V_{D4}=3.2V$	-3		3	%
		AP3607	$V_{D1}=V_{D2}=V_{D3}=V_{D4}=V_{D5}=V_{D6}=3.2V$				
Current Matching Between any Two Outputs	$I_{D-Match2}$	AP3606	$V_{D1}=V_{D2}=V_{D3}=V_{D4}=3.0V$ to 4.0V $V_{IN}=3.2V$ to 5.0V	-3.5		3.5	%
		AP3607	$V_{D1}=V_{D2}=V_{D3}=V_{D4}=V_{D5}=V_{D6}=3.0V$ to 4.0V $V_{IN}=3.2V$ to 5.0V				
<b>Enable Section</b>							
EN High Level Threshold Voltage	$V_{IH}$			1.5			V
EN Low Level Threshold Voltage	$V_{IL}$					0.5	V
EN Input Current	$I_{EN}$	$V_{EN}=0V$ to 5V			1	10	$\mu A$
EN Low to Shutdown Delay	$t_{SHDN}$					1	ms
EN Low Time for Dimming	$t_{LO}$			0.45		500	$\mu s$
EN High Time for Dimming	$t_{HI}$			0.45			$\mu s$
<b>Total Device</b>							
Soft-start Time	$t_{SS}$	AP3606	$I_D=80mA$ Total		200		$\mu s$
		AP3607	$I_D=120mA$ Total				
Inrush Current	$I_{INRUSH}$	AP3606	$V_{IN}=3.2V$ , $I_D=80mA$ Total		200		mA
		AP3607	$V_{IN}=3.2V$ , $I_D=120mA$ Total		320		
Over Voltage Protection	$V_{OVP}$	Note 2			5.5		V
Thermal Shutdown	$T_{OTSD}$				160		$^{\circ}C$
Thermal Shutdown Hysteresis	$T_{HYS}$				20		$^{\circ}C$
Thermal Resistance (Junction to Case)	$\theta_{JC}$	QFN-3x3-16			15		$^{\circ}C/W$

Note 2: Open circuit at any WLED that is programmed to be in the on state.

### Typical Performance Characteristics

$T_A=25^\circ\text{C}$ ,  $C_{IN}=C_1=C_2=C_{OUT}=1\mu\text{F}$ ,  $V_F=3.2\text{V}$ , unless otherwise noted.

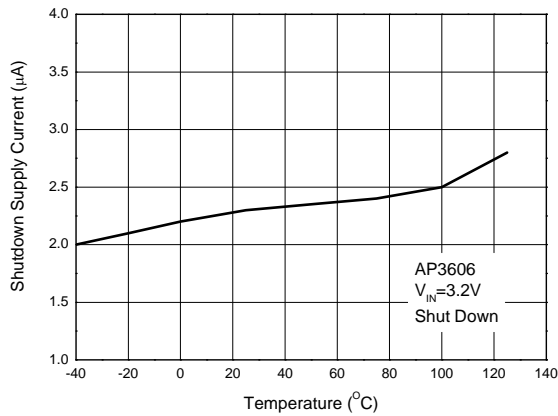

Figure 4. Shutdown Supply Current vs. Temperature

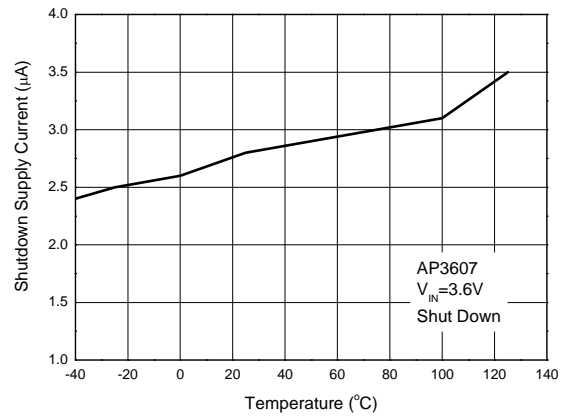

Figure 5. Shutdown Supply Current vs. Temperature

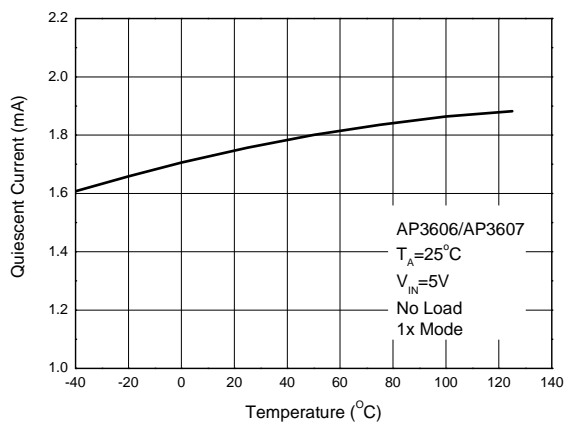

Figure 6. 1x Mode Quiescent Current vs. Temperature

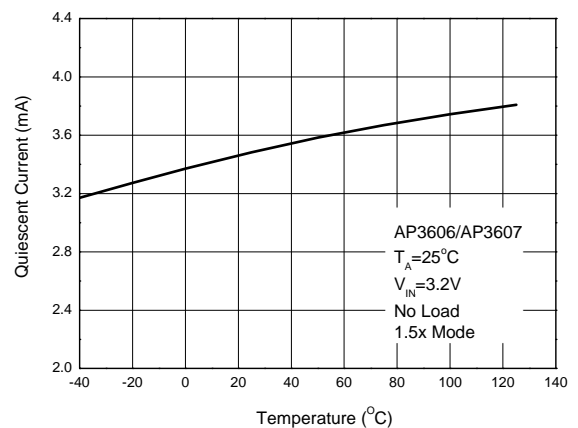

Figure 7. 1.5x Mode Quiescent Current vs. Temperature

### Typical Performance Characteristics (Continued)

$T_A=25^\circ\text{C}$ ,  $C_{IN}=C_1=C_2=C_{OUT}=1\mu\text{F}$ ,  $V_F=3.2\text{V}$ , unless otherwise noted.

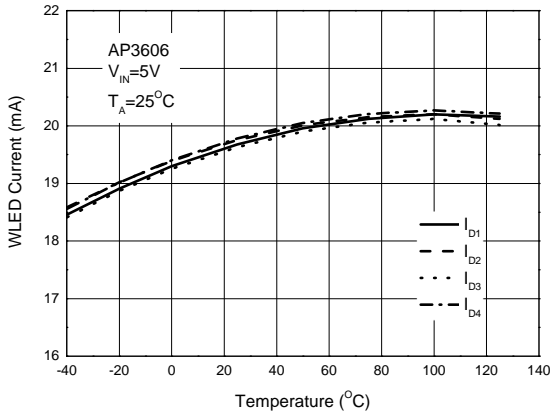

Figure 8. 1x Mode WLED Current vs. Temperature

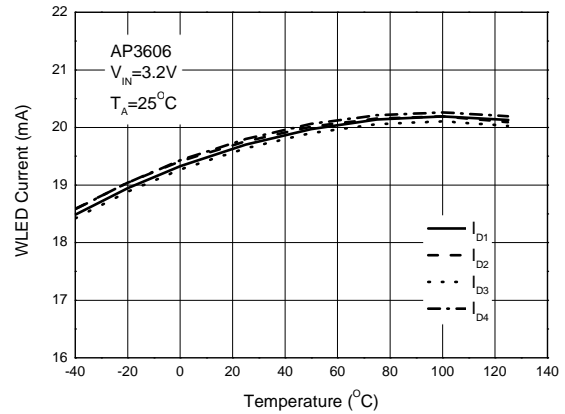

Figure 9. 1.5x Mode WLED Current vs. Temperature

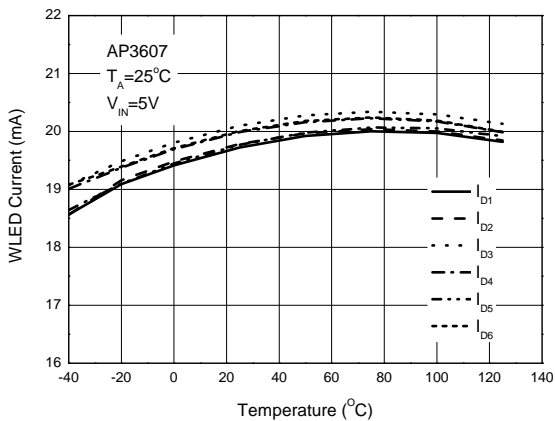

Figure 10. 1x Mode WLED Current vs. Temperature

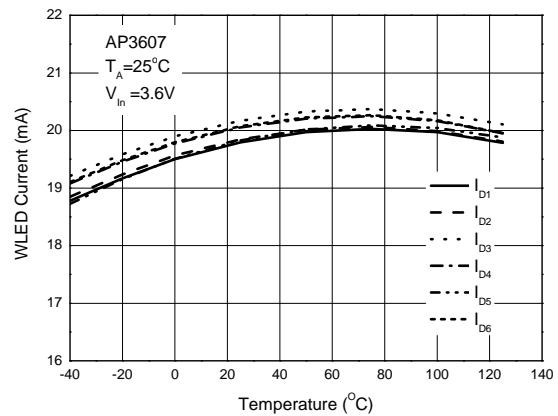

Figure 11. 1.5x Mode WLED Current vs. Temperature



### Typical Performance Characteristics (Continued)

$T_A=25^\circ\text{C}$ ,  $C_{IN}=C_1=C_2=C_{OUT}=1\mu\text{F}$ ,  $V_F=3.2\text{V}$ , unless otherwise noted.

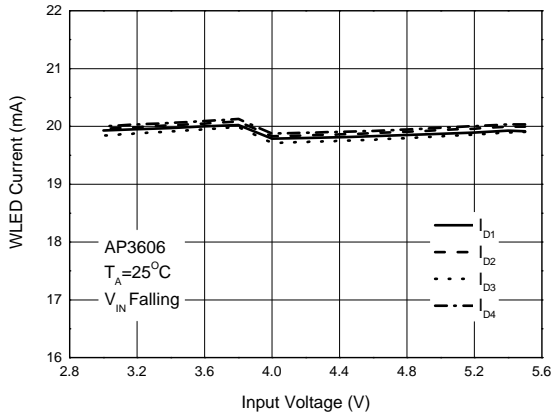

Figure 12. WLED Current vs. Input Voltage

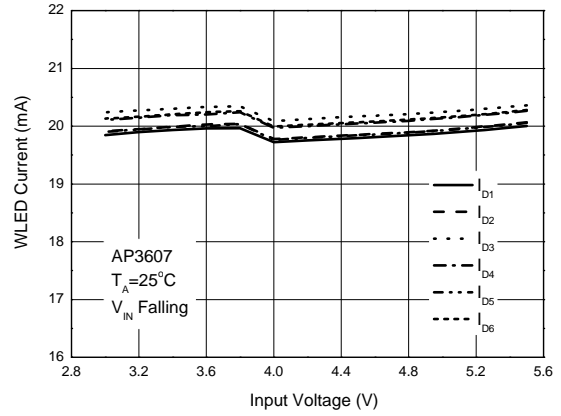

Figure 13. WLED Current vs. Input Voltage

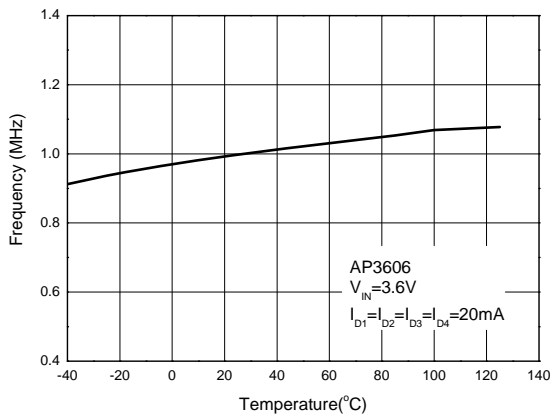

Figure 14. Frequency vs. Temperature

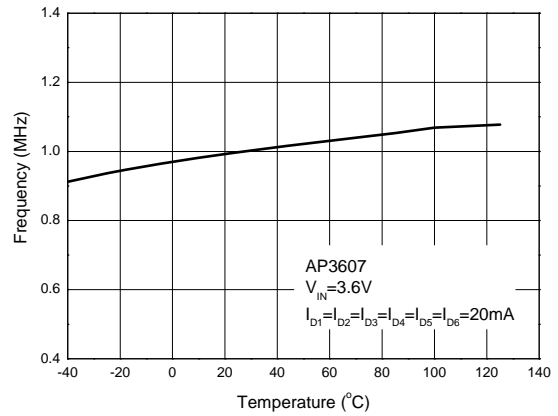

Figure 15. Frequency vs. Temperature

### Typical Performance Characteristics (Continued)

$T_A=25^\circ\text{C}$ ,  $C_{IN}=C_1=C_2=C_{OUT}=1\mu\text{F}$ ,  $V_F=3.2\text{V}$ , unless otherwise noted.

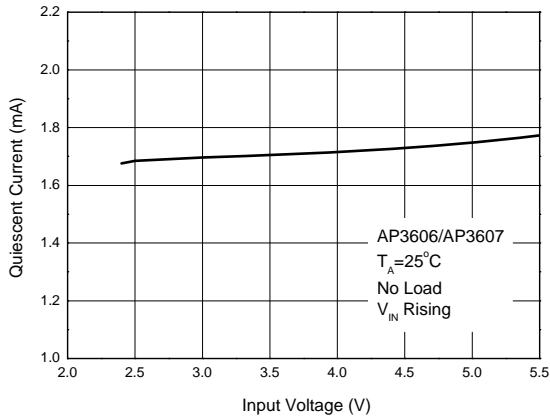

Figure 16. 1x Mode Quiescent Current vs. Input Voltage

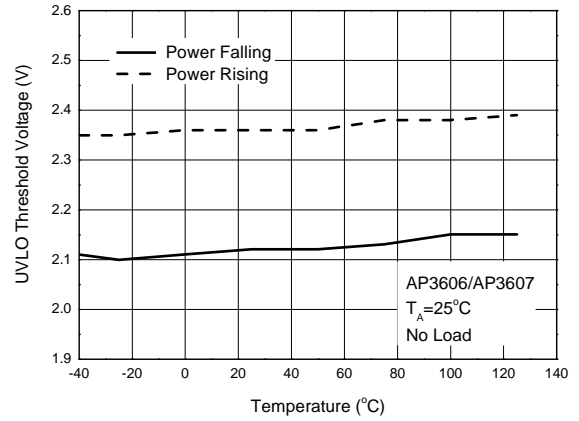

Figure 17. UVLO Threshold Voltage vs. Temperature

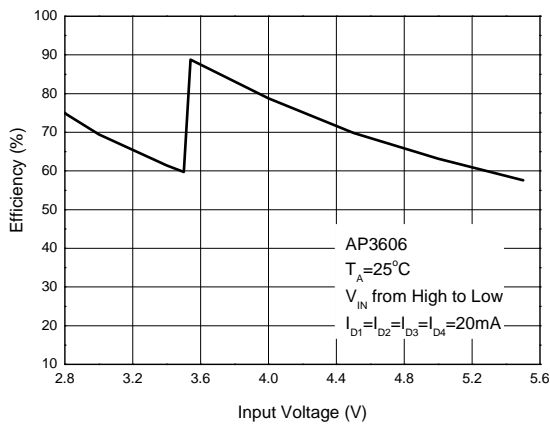

Figure 18. Efficiency vs. Input Voltage

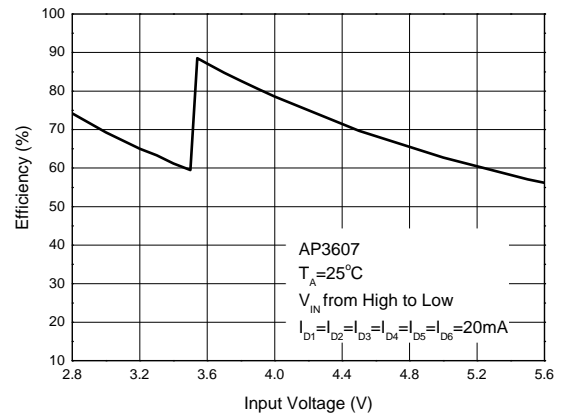
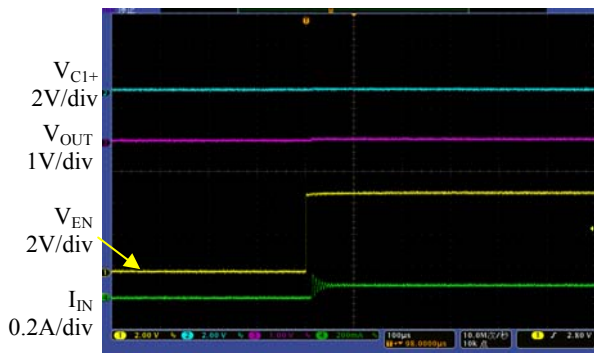

Figure 19. Efficiency vs. Input Voltage

### Typical Performance Characteristics (Continued)

$T_A=25^{\circ}\text{C}$ ,  $C_{IN}=C_1=C_2=C_{OUT}=1\mu\text{F}$ ,  $V_F=3.2\text{V}$ , unless otherwise noted.



Time (100µs/div)

Figure 20. 1x Mode Turn on Characteristic (AP3606)



Time (400µs/div)

Figure 21. 1x Mode Turn off Characteristic (AP3606)



Time (100µs/div)

Figure 22. 1x Mode Turn on Characteristic (AP3607)

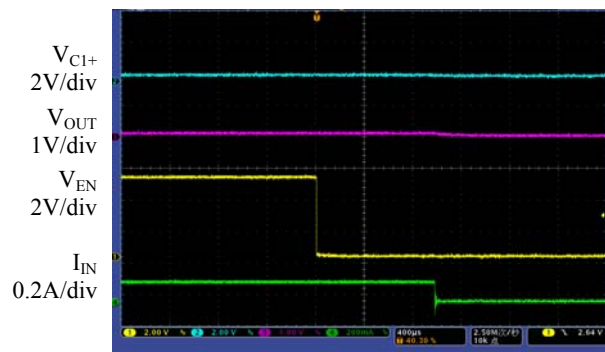

Time (400µs/div)

Figure 23. 1x Mode Turn off Characteristic (AP3607)

### Typical Performance Characteristics (Continued)

$T_A=25^\circ\text{C}$ ,  $C_{IN}=C_1=C_2=C_{OUT}=1\mu\text{F}$ ,  $V_F=3.2\text{V}$ , unless otherwise noted.

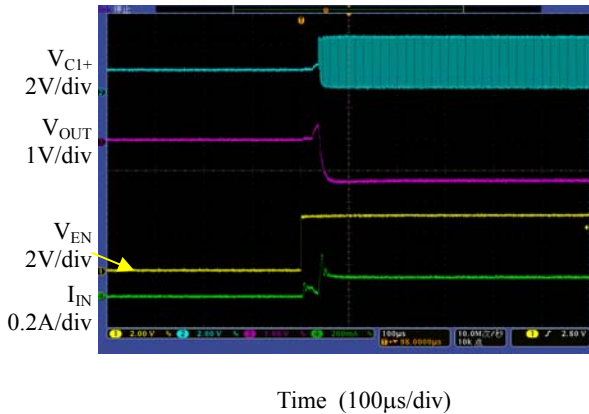

Figure 24. 1.5x Mode Turn on Characteristic (AP3606)

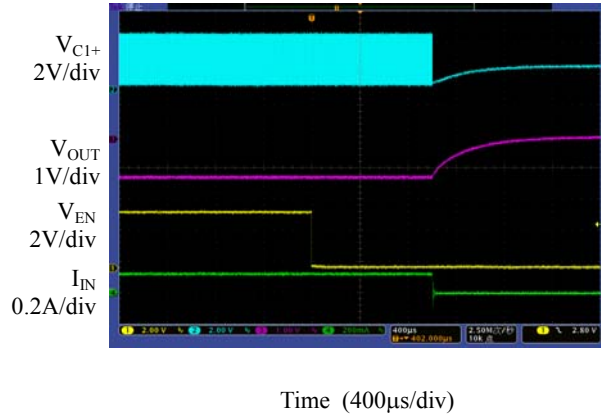

Figure 25. 1.5x Mode Turn off Characteristic (AP3606)

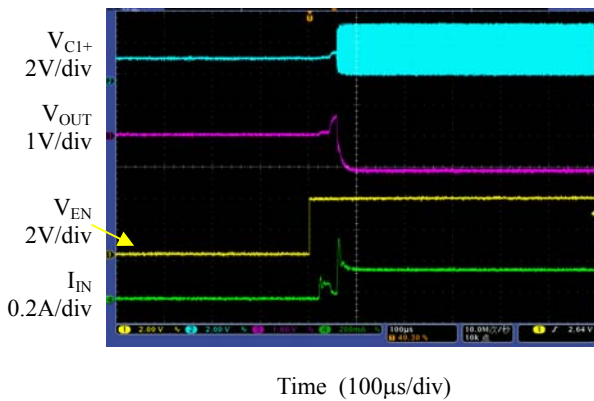

Figure 26. 1.5x Mode Turn on Characteristic (AP3607)

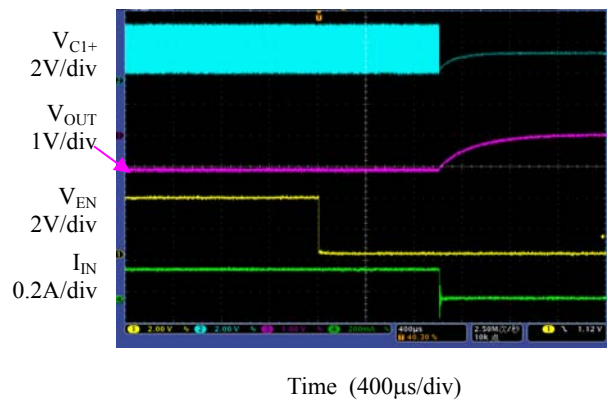

Figure 27. 1.5x Mode Turn off Characteristic (AP3607)

### Typical Performance Characteristics (Continued)

$T_A=25^\circ\text{C}$ ,  $C_{IN}=C_1=C_2=C_{OUT}=1\mu\text{F}$ ,  $V_F=3.2\text{V}$ , unless otherwise noted.

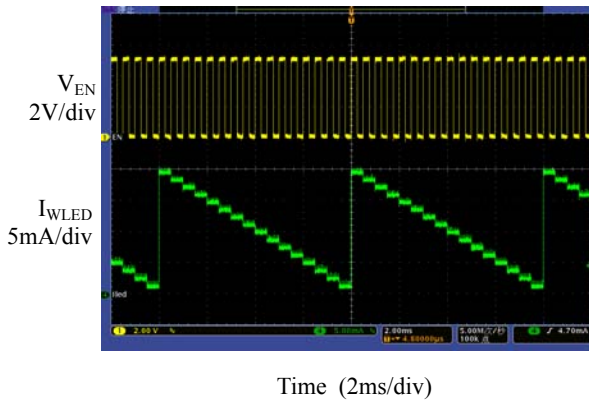

Figure 28. 1x Mode Dimming Operation (AP3606,  $V_{IN}=5\text{V}$ ,  $f_{EN}=2\text{kHz}$ )

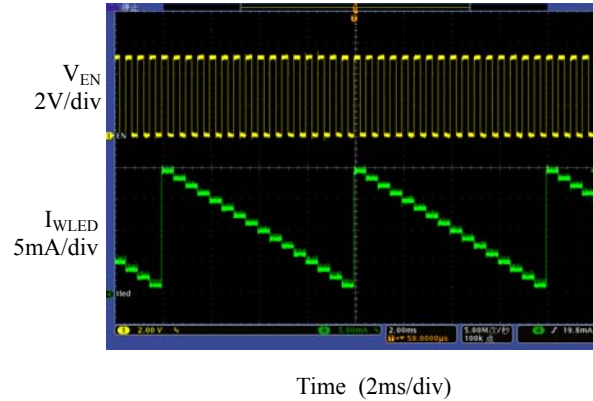

Figure 29. 1x Mode Dimming Operation (AP3607,  $V_{IN}=5\text{V}$ ,  $f_{EN}=2\text{kHz}$ )

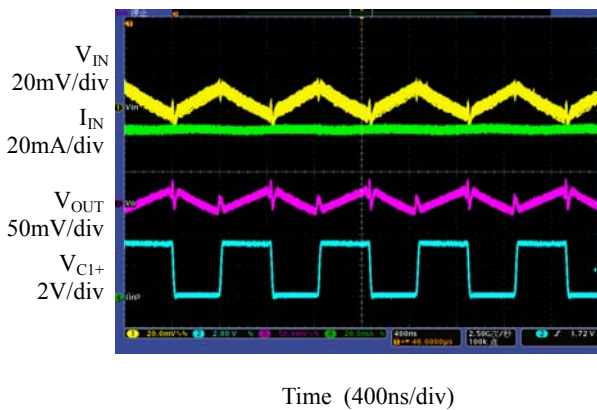

Figure 30. Output Ripple (AP3606,  $V_{IN}=3.3\text{V}$ ,  $I_D=80\text{mA}$ )

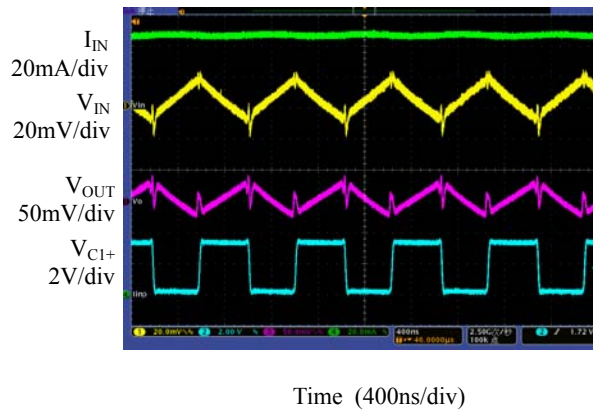

Figure 31. Output Ripple (AP3607,  $V_{IN}=3.3\text{V}$ ,  $I_D=120\text{mA}$ )

### Digital Dimming Operating Diagram

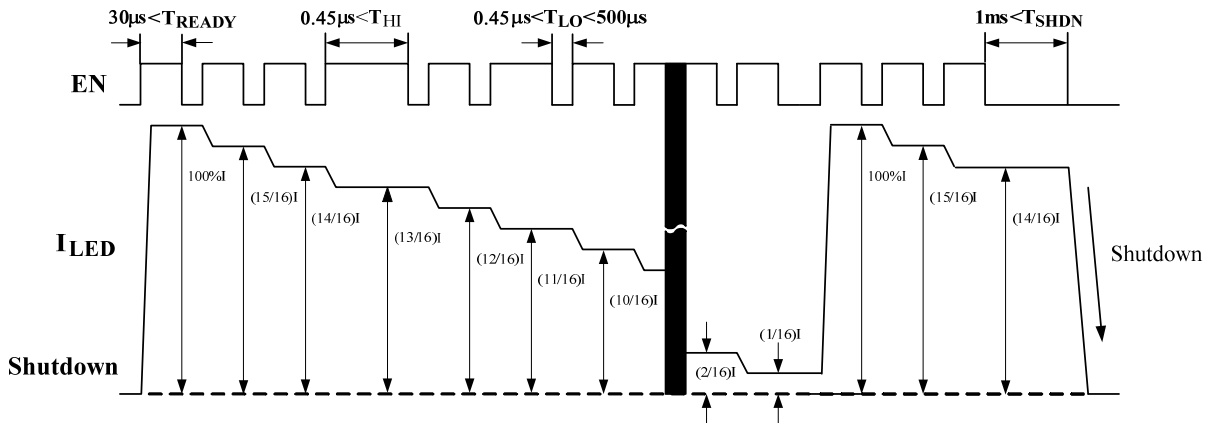
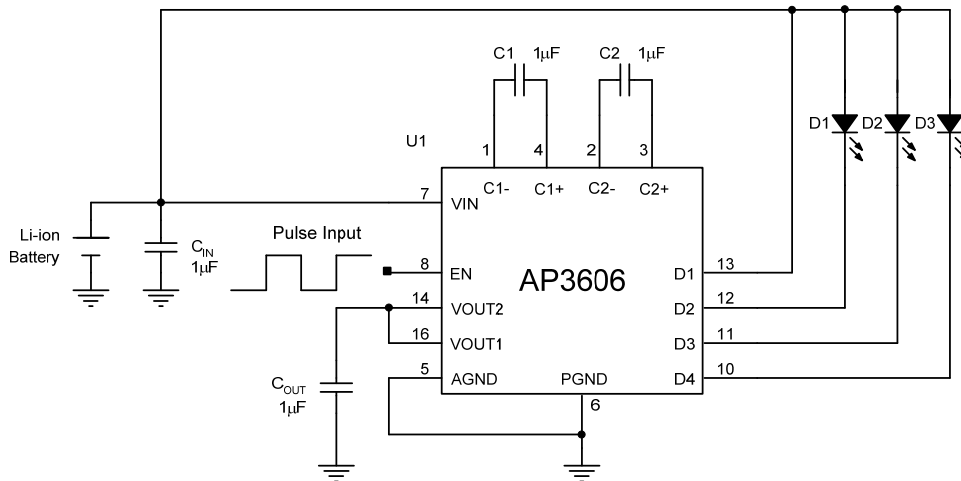

Figure 32. Digital Dimming Operating Diagram of AP3606/AP3607

Note 3: The dimming control can be achieved by applying a pulse to the EN pin. When the low level duration time of pulse is between  $T_{LOmin}$  and  $T_{LOmax}$ , and the high level duration time is larger than  $T_{HImin}$ , the LED current will decrease 1/16. If the low level duration time is larger than  $T_{SHDNmax}$ , the IC will be turned off. When AP3606/AP3607 is powered on, the WLED is in full brightness. And it will keep maximum current until the pulse is detected. After 15 pulses the WLED current decreases to 1/16 of full brightness. It will increase to full brightness if a pulse is added to EN pin then.

### Typical Application



3 WLEDs

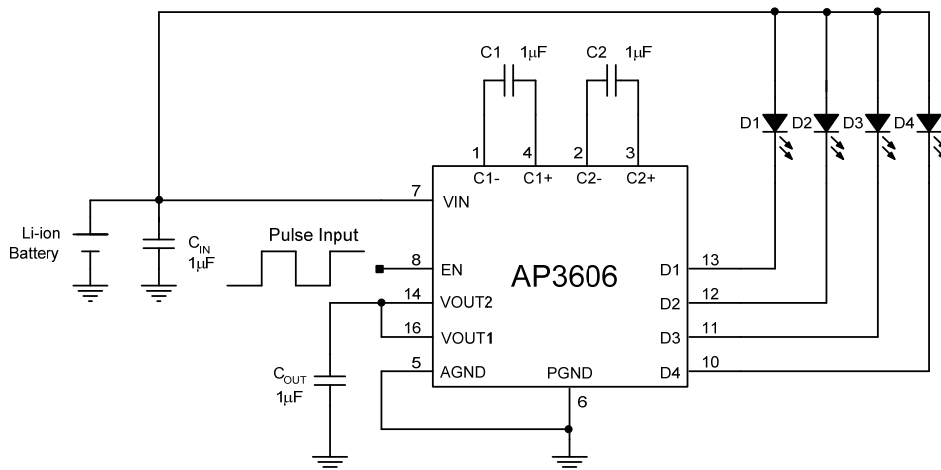

4 WLEDs

Typical Application (Continued)

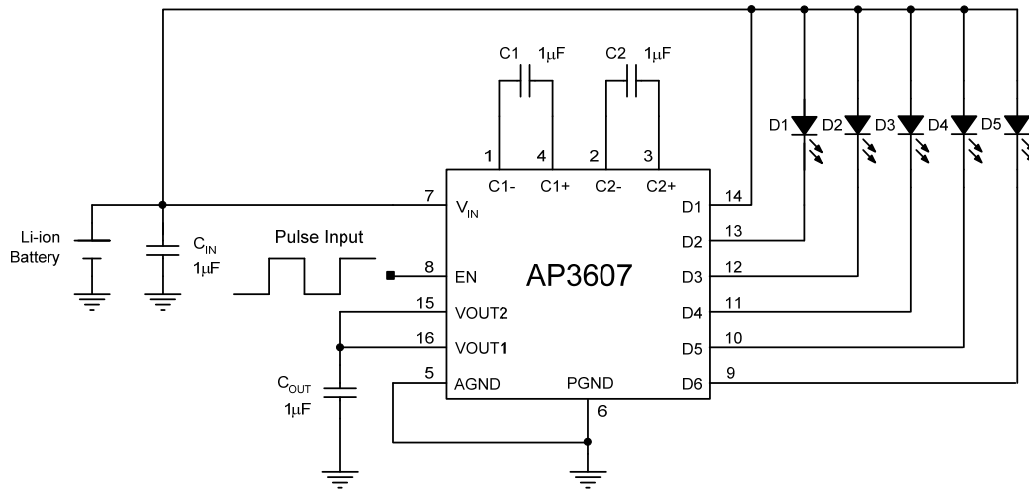

5 WLEDs

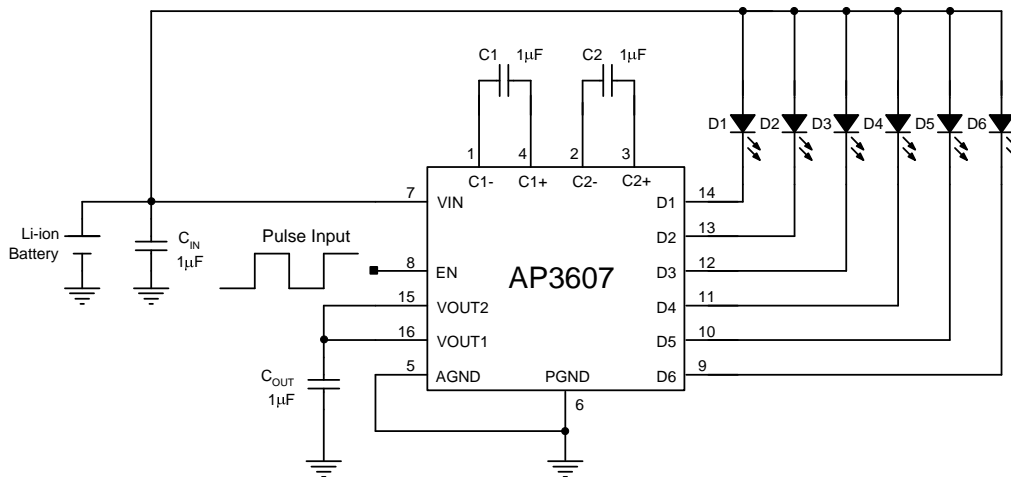

6 WLEDs

Figure 33. Typical Applications of AP3606/AP3607

Detailed application information, please refer to AP3606/AP3607 application note.



**Mechanical Dimensions**

**QFN-3x3-16**

**Unit: mm(inch)**

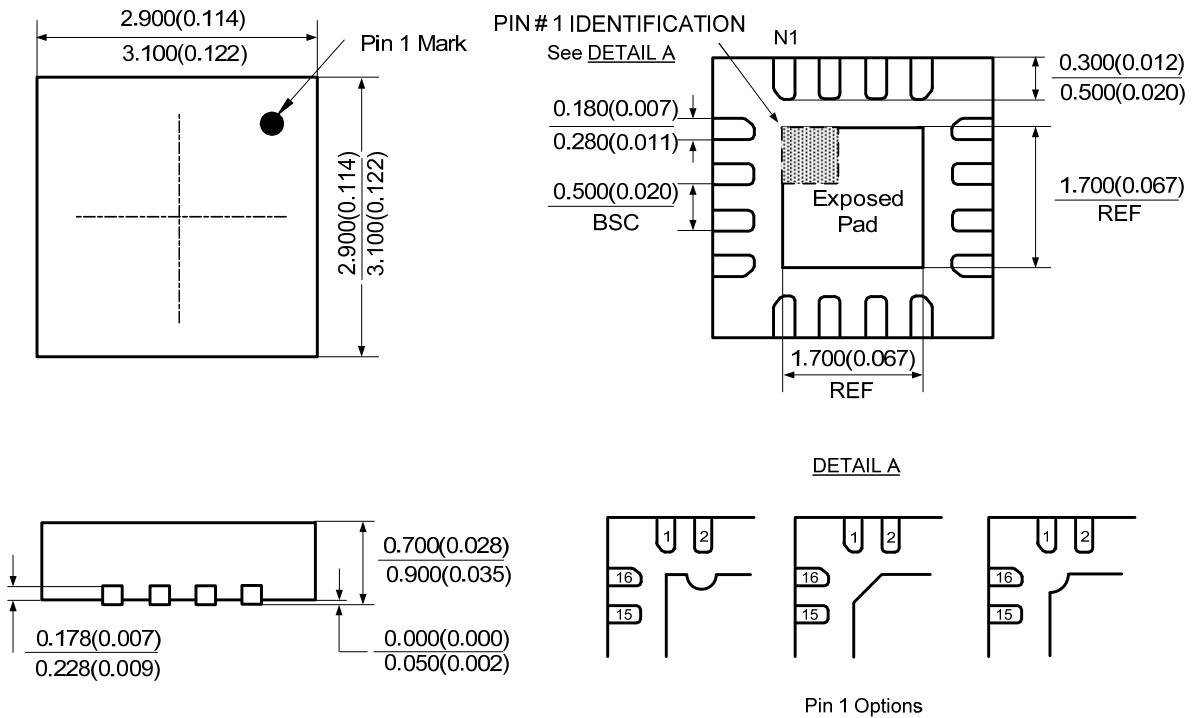



## BCD Semiconductor Manufacturing Limited

<http://www.bcdsemi.com>

### IMPORTANT NOTICE

BCD Semiconductor Manufacturing Limited reserves the right to make changes without further notice to any products or specifications herein. BCD Semiconductor Manufacturing Limited does not assume any responsibility for use of any its products for any particular purpose, nor does BCD Semiconductor Manufacturing Limited assume any liability arising out of the application or use of any its products or circuits. BCD Semiconductor Manufacturing Limited does not convey any license under its patent rights or other rights nor the rights of others.

---

#### MAIN SITE

##### - Headquarters

##### BCD Semiconductor Manufacturing Limited

No. 1600, Zi Xing Road, Shanghai ZiZhu Science-based Industrial Park, 200241, China  
Tel: +86-21-24162266, Fax: +86-21-24162277

##### - Wafer Fab

##### Shanghai SIM-BCD Semiconductor Manufacturing Co., Ltd.

800 Yi Shan Road, Shanghai 200233, China  
Tel: +86-21-6485 1491, Fax: +86-21-5450 0008

#### REGIONAL SALES OFFICE

##### Shenzhen Office

##### Shanghai SIM-BCD Semiconductor Manufacturing Co., Ltd., Shenzhen Office

Unit A Room 1203, Skyworth Bldg., Gaoxin Ave. 1.S., Nanshan District, Shenzhen, China  
Tel: +86-755-8826 7951  
Fax: +86-755-8826 7865

##### Taiwan Office

##### BCD Semiconductor (Taiwan) Company Limited

4F, 298-1, Rui Guang Road, Nei-Hu District, Taipei, Taiwan  
Tel: +886-2-2656 2808  
Fax: +886-2-2656 2806

##### USA Office

##### BCD Semiconductor Corp.

30920 Huntwood Ave. Hayward, CA 94544, USA  
Tel : +1-510-324-2988  
Fax: +1-510-324-2788