

Product Document

AS1111

Low-Dropout LED Drivers

General Description

The AS1111A/AS1111B/AS1111C are LED drivers designed to match current source bias for any color LED, including white and blue. The devices can drive up to 4 high-current LEDs, and the LED current is programmable using an external resistor (RSET).

The AS1111A LED currents are $460 \times I_{SET}$ (per LED, typ) at an LED cathode voltage (V_{SAT}) of 150mV and $650 \times I_{SET}$ (typ) at a V_{SAT} of 1V, where I_{SET} is the current through RSET connected to pin CTRL.

The AS1111B & AS1111C LED currents are $230 \times I_{SET}$ (per LED, typ) at a V_{SAT} of 150mV and $325 \times I_{SET}$ (typ) at a V_{SAT} of 1V.

All AS1111 versions incorporate a chip-enable feature via pin EN. When the devices are disabled, the supply current drops down to less than 1 μ A. The AS1111A and AS1111B are available in a 6-pin WL-CSP package with 0.4mm pitch. The AS1111C is available in an 8-pin MLPD (2x2mm) package with 0.5mm pitch.

Ordering Information and Content Guide appear at end of datasheet.

Key Benefits & Features

The benefits and features of AS1111, Low-Dropout LED Drivers are listed below:

Figure 1:
Added Value of Using AS1111

Benefits	Features
High efficient	<ul style="list-style-type: none"> Ultra Low Voltage Drop: less than 150mV
Supports a variety of end applications	<ul style="list-style-type: none"> Analog and PWM Brightness Control Up to 80mA per LED (AS1111A) Up to 40mA per LED (AS1111B, AS1111C)
Extended battery life	<ul style="list-style-type: none"> Active-Low Shutdown Mode Low Shutdown Current: less than 1μA
Suitable for EMF sensitive environment	<ul style="list-style-type: none"> No electromagnetic interference No switching noise
Small PCB area	<ul style="list-style-type: none"> Less external components needed
Cost effective, small package	<ul style="list-style-type: none"> 6-pin WL-CSP with 0.4mm pitch 8-pin MLPD (2x2mm) with 0.5mm pitch

Applications

The AS1111 devices are ideal for LED displays and keyboard backlights, as well as lighting management units for battery powered audio devices such as

- MP3 and CD players,
- Mobile and cordless phones,
- PDAs,
- Portable DVD players, and
- Consumer electronics.

Application Diagram

The typical application diagram of this device for reference is shown below:

Figure 2:
AS1111 Typical Application Diagram

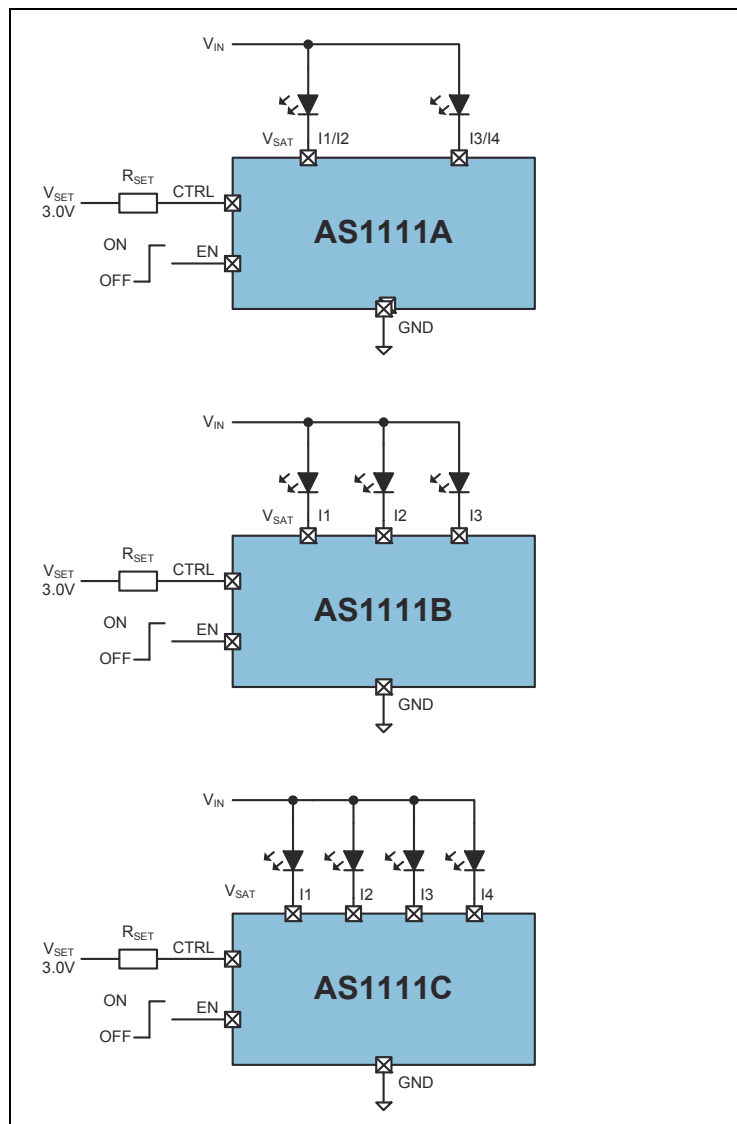

Pin Assignment

Figure 3:
Pin Assignment of AS1111A/B and AS1111C

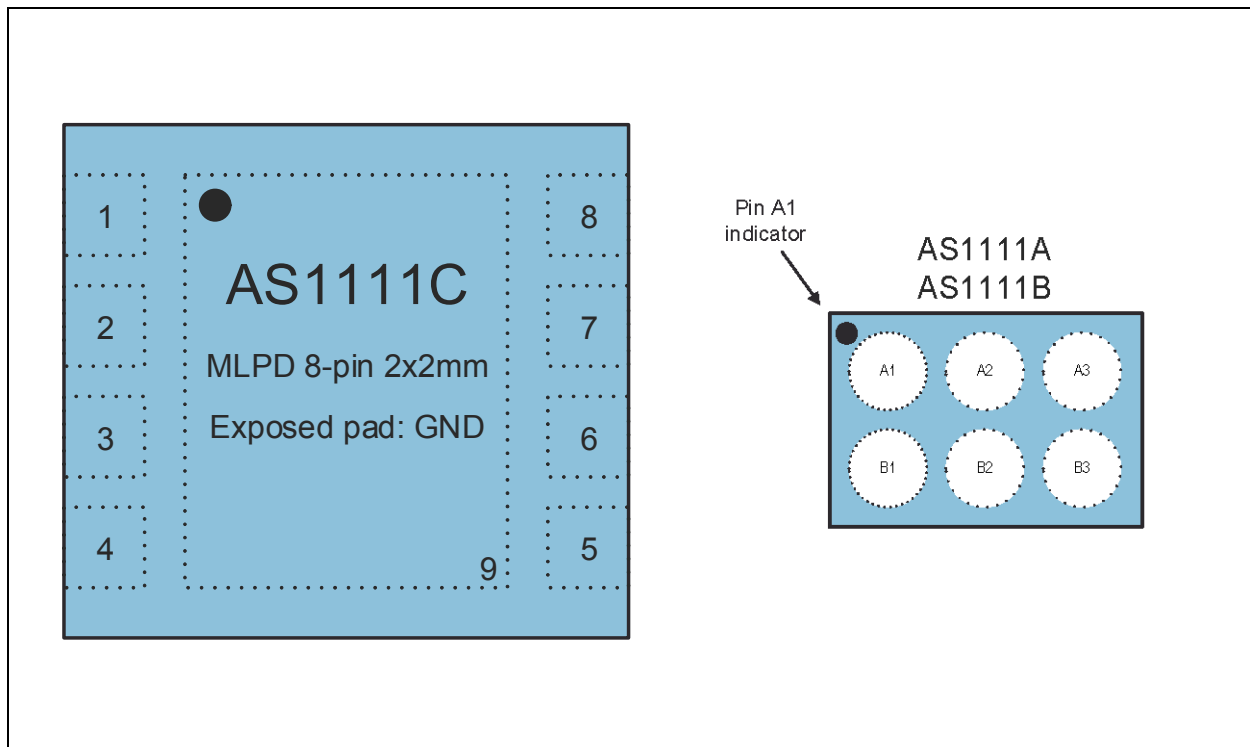

Pin Assignment: Shows the TOP through view pin assignment of the AS1111A/B and AS1111C.

Pin Description

Figure 4:
Pin Description of AS1111

Pin Number			Pin Name	Description
AS1111A	AS1111B	AS1111C		
A2	A2	4	GND	Ground. Connect to GND
B2	-	-	GND	Ground. Connect to GND (AS1111A)
B3	B3	7	CTRL	Control. Sets the LED current; connect to external resistor RSET
B1	B1	1	EN	Enable. Device enable/PWM Input. 1 = Normal Operation 0 = Shutdown
-	A3	5	I1	Input1. Connect to cathode of LED1 (AS1111B&C)
-	B2	6	I2	Input2. Connect to cathode of LED2 (AS1111B&C)
-	A1	2	I3	Input3. Connect to cathode of LED3 (AS1111B&C)

Pin Number			Pin Name	Description
AS1111A	AS1111B	AS1111C		
A3	-	-	I1/I2	Input1/2. Connect to cathode of LED1 (AS1111A)
A1	-	-	I3/I4	Input3/4. Connect to cathode of LED2 (AS1111A)
-	-	3	I4	Input4. Connect to cathode of LED4 (AS1111C)
		8	NC	Not Connected. (AS1111C)
-	-	9		Exposed Pad. Connect this pad to the GND plane on the PCB to maximize power dissipation (AS1111C)

Pin Description: Shows the pin number, name and description of every pin.

Absolute Maximum Ratings

Stresses beyond those listed under [Absolute Maximum Ratings](#) may cause permanent damage to the device. These are stress ratings only. Functional operation of the device at these or any other conditions beyond those indicated under [Electrical Characteristics](#) is not implied. Exposure to absolute maximum rating conditions for extended periods may affect device reliability.

Figure 5:
Absolute Maximum Ratings

Symbol	Parameter	Min	Max	Units	Comments
Electrical Parameters					
	Supply Voltage to Ground 5V pins	-0.3	5.0	V	Applicable for pins: I1, I2, I3, I4, I1/I2, I3/I4, CTRL, EN
	Input Current (latch-up immunity)	-100	100	mA	Norm: JEDEC JESD78
Electrostatic Discharge					
ESD _{HBM}	Electrostatic Discharge HBM	±2		kV	Norm: JEDEC JESD22-A114F
Temperature Ranges and Storage Conditions					
T _A	Operating Temperature	-40	85	°C	
R _{THJA} ⁽¹⁾	Junction to Ambient Thermal Resistance		60	°C/W	MLPD
			95	°C/W	WL-CSP
T _J	Junction Temperature		125	°C	WL-CSP
T _{STRG}	Storage Temperature Range	-55	125	°C	
T _{BODY}	Package Body Temperature		260	°C	Norm: IPC/JEDEC J-STD-020 ⁽²⁾
RH _{NC}	Relative Humidity non-condensing	5	85	%	
MSL	Moisture Sensitivity Level (WL-CSP & MLPD)	1			Represents an unlimited floor life time

Note(s) and/or Footnote(s):

1. Junction-to-ambient thermal resistance is very dependent on application and board-layout. In situations where high maximum power dissipation exists, special attention must be paid to thermal dissipation during board design.
2. The reflow peak soldering temperature (body temperature) is specified according to IPC/JEDEC J-STD-020 "Moisture/Reflow Sensitivity Classification for Non-hermetic Solid State Surface Mount Devices."

Electrical Characteristics

All limits are guaranteed. The parameters with min and max values are guaranteed with production tests or SQC (Statistical Quality Control) methods.

Figure 6:
Electrical Characteristics

Symbol	Parameter	Note	Min	Typ	Max	Unit
V_{SAT}	Cathode Voltage	at pins I1, I2, I3, I4, I1/I2, I3/I4	0.15	0.6	3.6	V
V_{EN_HIGH}	Enable Voltage High	pin EN	2.2		3.6	V
V_{EN_LOW}	Enable Voltage Low	pin EN	0		0.5	V
I_{SET}	I_{SET} range	$V_{EN} = 3V$	25		150	μA
I_{SET_OFF}	I_{SET} in OFF mode	$V_{CTRL} = 3V, V_{SAT} = 3V, V_{EN} = 0V$		0.1	1	μA
I_{IN_OFF}	I_{IN} in OFF mode	$V_{CTRL} = 3V, V_{SAT} = 3V, V_{EN} = 0V, T_{AMB} = 25^{\circ}C$		0.1	1	μA
		$V_{CTRL} = 3V, V_{SAT} = 3V, V_{EN} = 0V, T_{AMB} = -40^{\circ}C$ to $85^{\circ}C$ (for AS1111A)			4	μA
		$V_{CTRL} = 3V, V_{SAT} = 3V, V_{EN} = 0V, T_{AMB} = -40^{\circ}C$ to $85^{\circ}C$			2	μA
Eff ⁽¹⁾	Peak Efficiency	$V_{IN} = 3V, V_{EN} = 3V$	95			%
Match	LED to LED Current Matching	$V_{EN} = 3V$	-3		3	%

Electrical Characteristics: Shows the Electrical Characteristics of the LED Driver. $T_{AMB} = -40$ to $85^{\circ}C$ (unless otherwise specified)

Note(s) and/or Footnote(s):

1. Efficiency = $(V_{IN} - V_{SAT})/V_{IN}$. Guaranteed by design.

Figure 7:
Output Current Multiplication Ratio

AS1111A	$I_{SET} = 25\mu A, V_{SAT} = 150mV, V_{EN} = 3V$	350	500	650
	$I_{SET} = 40\mu A, V_{SAT} = 150mV, V_{EN} = 3V$	335	480	625
	$I_{SET} = 75\mu A, V_{SAT} = 150mV, V_{EN} = 3V$	295	420	545
	$I_{SET} = 25\mu A, V_{SAT} = 600mV, V_{EN} = 3V$	435	620	805
	$I_{SET} = 40\mu A, V_{SAT} = 600mV, V_{EN} = 3V$	425	610	795
	$I_{SET} = 75\mu A, V_{SAT} = 600mV, V_{EN} = 3V$	415	590	765
	$I_{SET} = 25\mu A, V_{SAT} = 1V, V_{EN} = 3V$	470	670	870
	$I_{SET} = 40\mu A, V_{SAT} = 1V, V_{EN} = 3V$	460	660	860
	$I_{SET} = 75\mu A, V_{SAT} = 1V, V_{EN} = 3V$	440	630	820
AS1111B AS1111C	$I_{SET} = 25\mu A, V_{SAT} = 150mV, V_{EN} = 3V$	175	250	325
	$I_{SET} = 40\mu A, V_{SAT} = 150mV, V_{EN} = 3V$	170	240	310
	$I_{SET} = 75\mu A, V_{SAT} = 150mV, V_{EN} = 3V$	145	210	275
	$I_{SET} = 25\mu A, V_{SAT} = 600mV, V_{EN} = 3V$	220	310	405
	$I_{SET} = 40\mu A, V_{SAT} = 600mV, V_{EN} = 3V$	215	305	395
	$I_{SET} = 75\mu A, V_{SAT} = 600mV, V_{EN} = 3V$	205	295	385
	$I_{SET} = 25\mu A, V_{SAT} = 1V, V_{EN} = 3V$	235	335	435
	$I_{SET} = 40\mu A, V_{SAT} = 1V, V_{EN} = 3V$	230	330	430
	$I_{SET} = 75\mu A, V_{SAT} = 1V, V_{EN} = 3V$	220	315	410

Output Current Multiplication Ratio: Shows the OCMR of the LED Driver for setting of I_{SET} and different Cathode Voltages V_{SAT} . $T_{AMB} = -40$ to $85^{\circ}C$ (unless otherwise specified)

Typical Operating Characteristics

Figure 8:
SET Current vs. CTRL Voltage

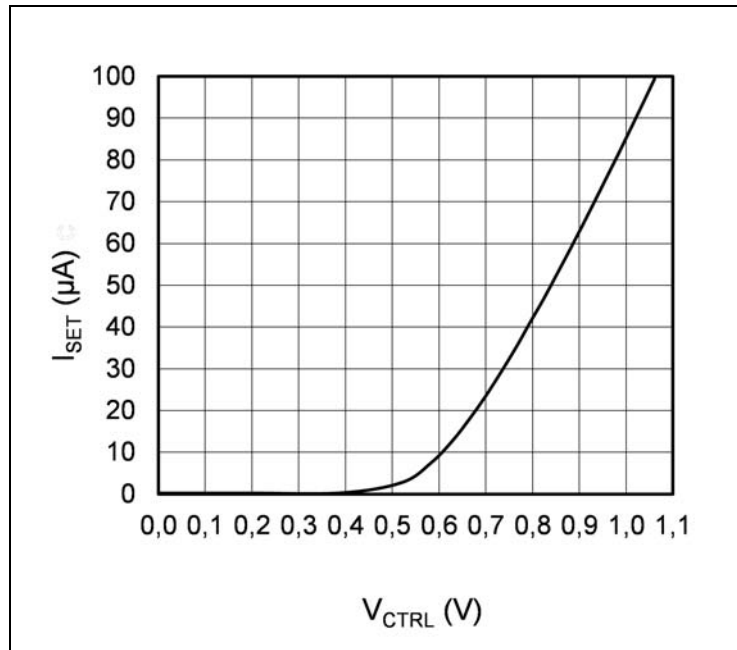

Figure 9:
SET Current vs. SET Voltage, $R_{SET} = 30k\Omega$

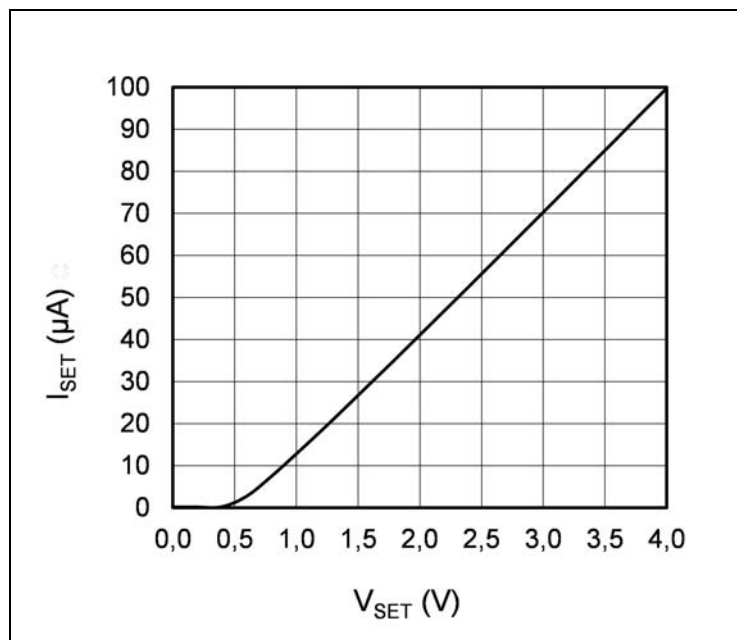

Figure 10:
LED Current vs. SAT Voltage

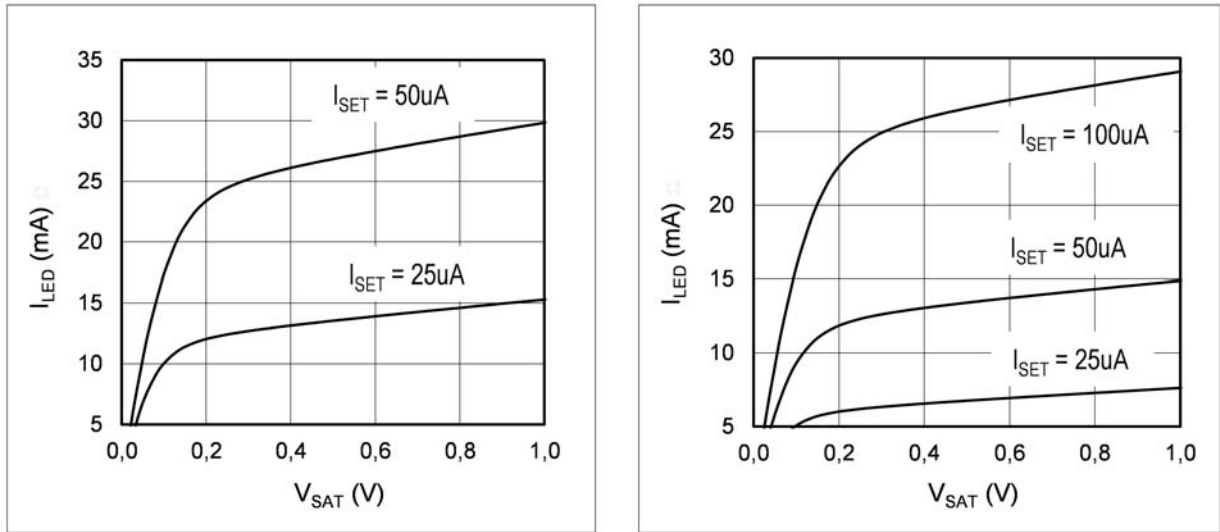

Figure 11:
OCMR vs. SET Current

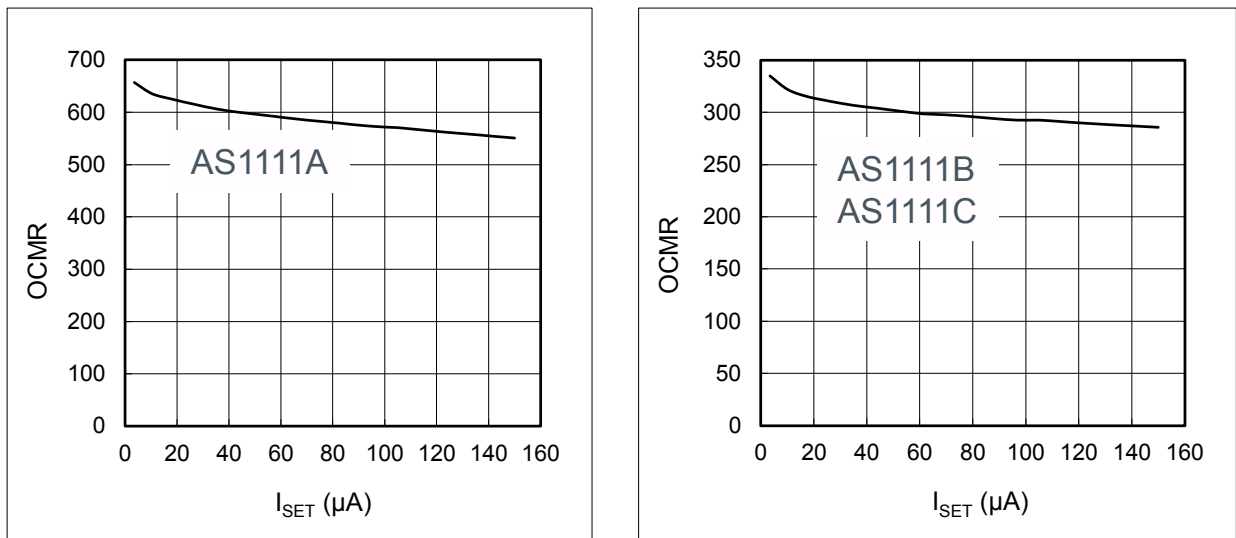

Figure 12:
LED Current vs. SET Resistor, $V_{SET} = 3V$

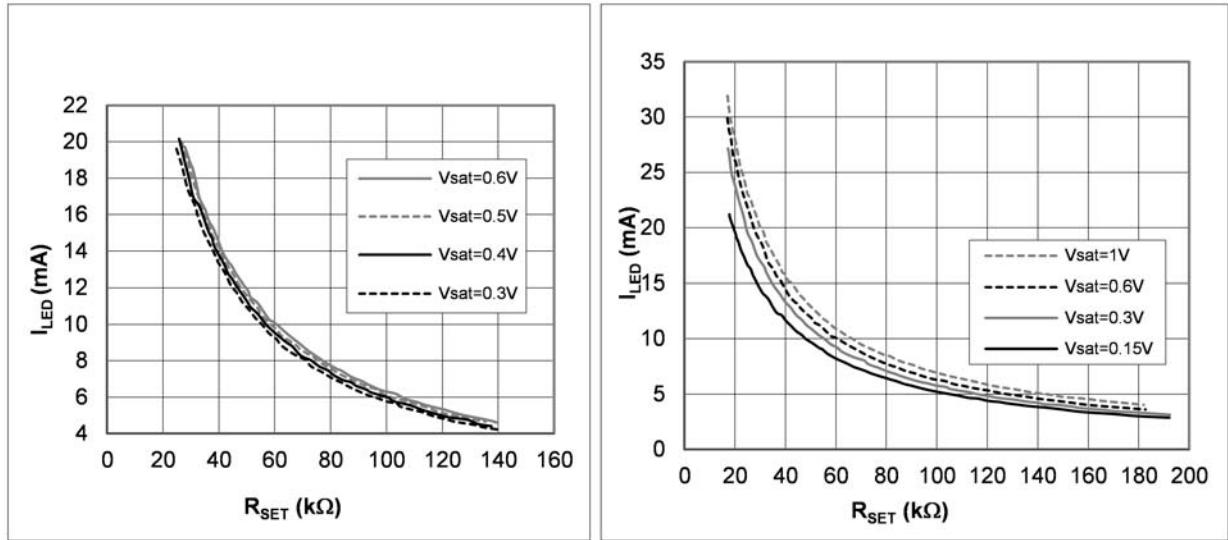

Figure 13:
LED Current vs. SET Resistor, $V_{SET} = 3V$

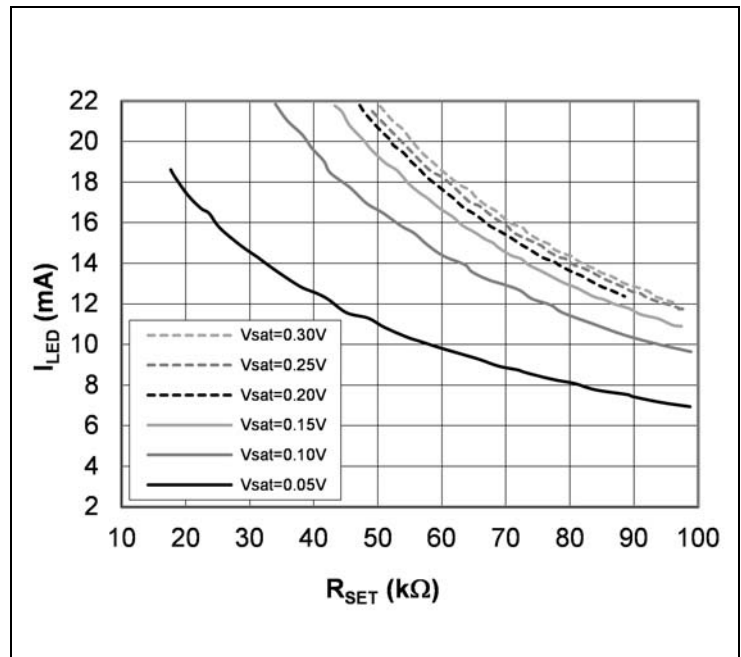

Figure 14:
LED Current vs. Temperature, $V_{LED} = -0.25V$, $I_{SET} = 50\mu A$

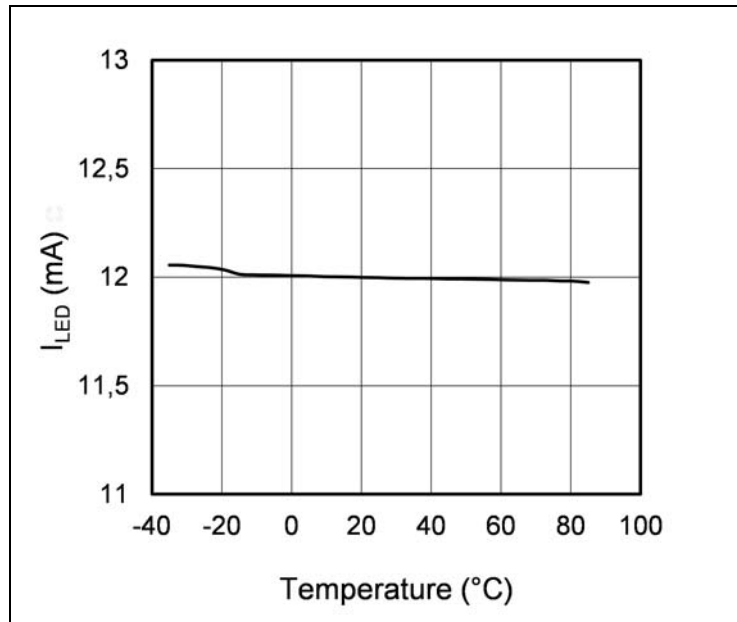

Figure 15:
LED Current vs. SET Current

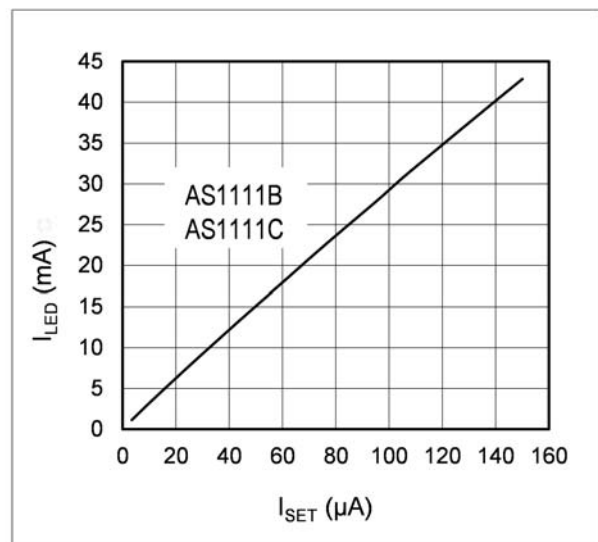
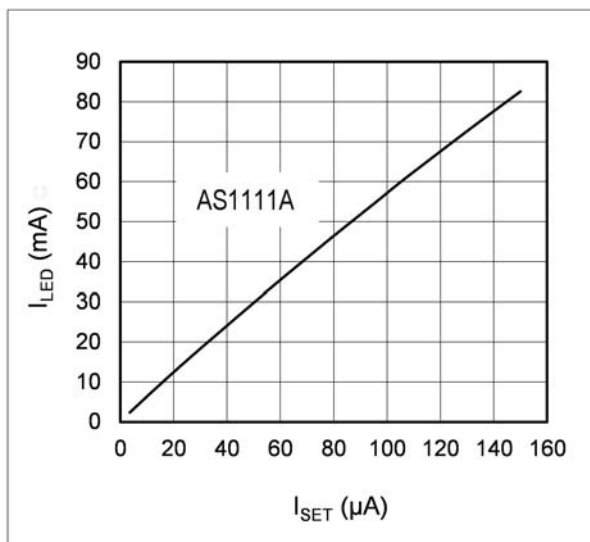

Figure 16:
 V_{SET} Voltage Transient Response

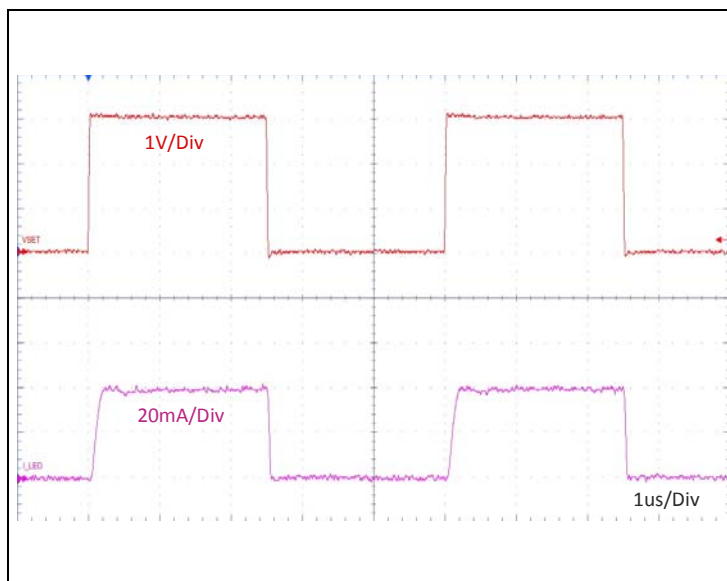
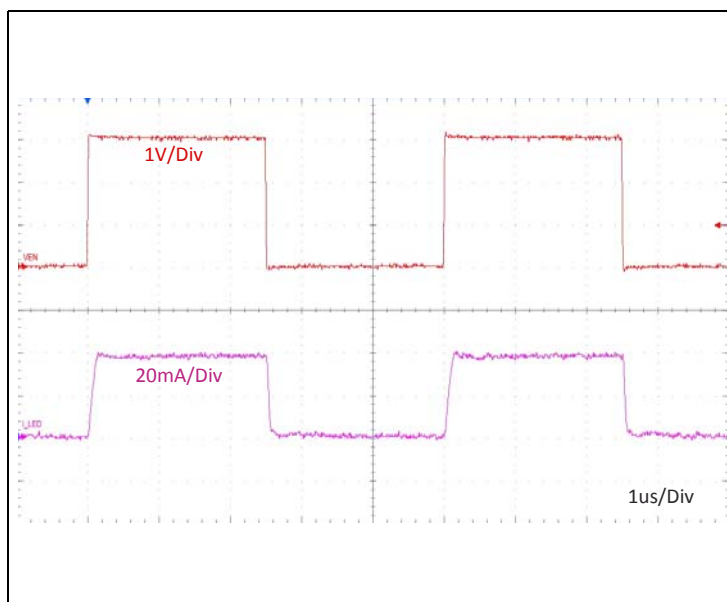

Figure 17:
 V_{EN} Voltage Transient Response



Detailed Description

Setting of the LED Current

The current going into the LEDs is approximately OCMR times greater than the current I_{SET} . The LED current is controlled by V_{SET} and R_{SET} according to the formula:

$$(EQ1) \quad I_{LED} = OCMR \cdot \frac{V_{SET} - V_{CTRL}}{R_{SET}}$$

For $V_{SET} = 3V$ and a specific LED current, the value of R_{SET} can be determined using the graphs shown in [Figure 12](#) and [Figure 13](#). For any other option, the value of I_{SET} can be determined using the graph in [Figure 8](#).

LED brightness can also be adjusted by driving pin EN or pin CTRL with a PWM signal.

Package Drawings & Markings

Figure 18:
MLPD-8 2x2mm 0.5mm Pitch Package Drawing

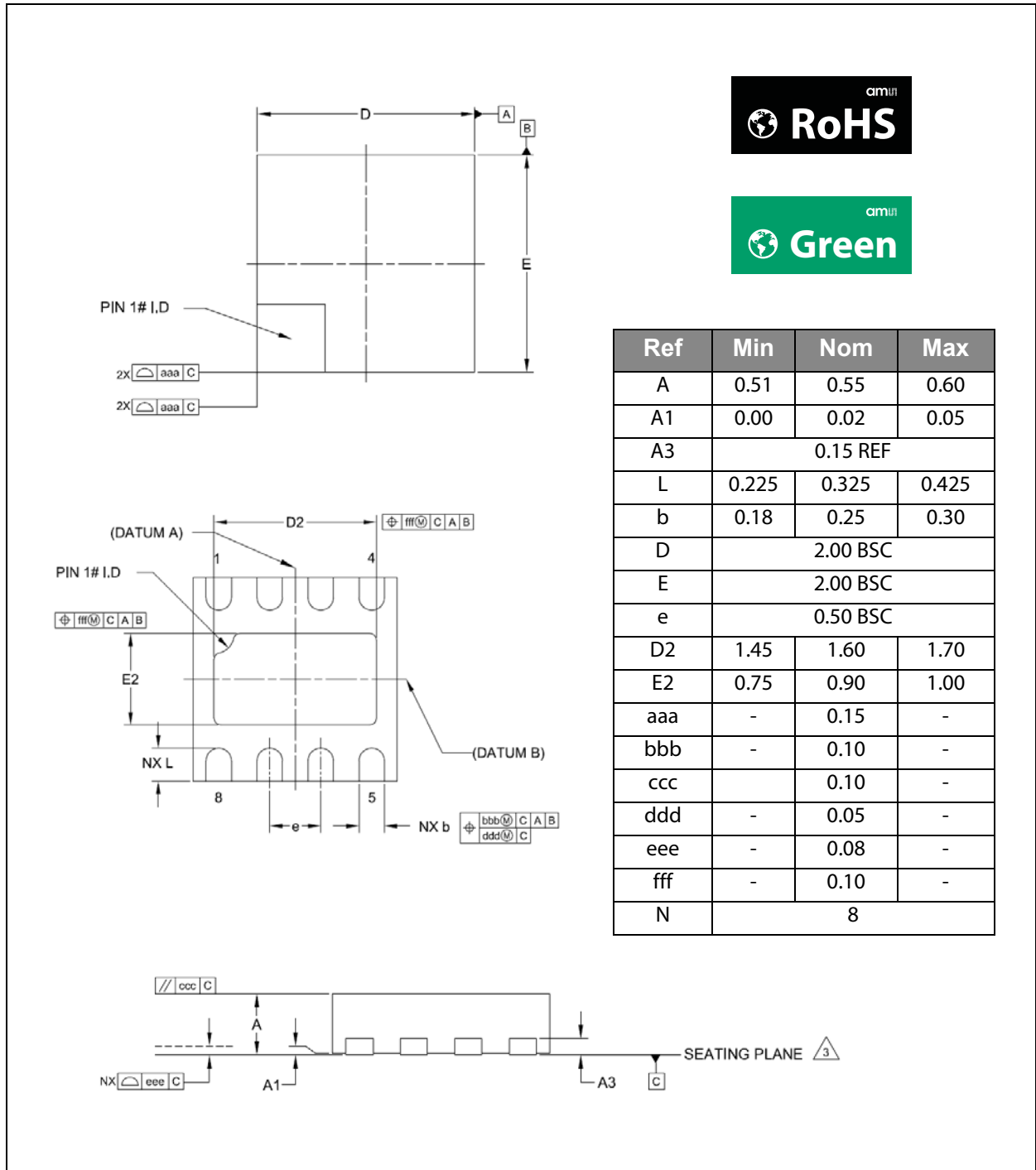

Note(s) and/or Footnote(s):

1. Dimensioning and Tolerancing conform to ASME Y14.5M-1994.
2. All dimensions are in millimeters. Angles are in degrees.
3. Coplanarity applies to the exposed heat slug as well as the terminal.
4. Radius on terminal is optional.
5. N is the total number of terminals.

Figure 20:
AS1111A & AS1111B Package Marking

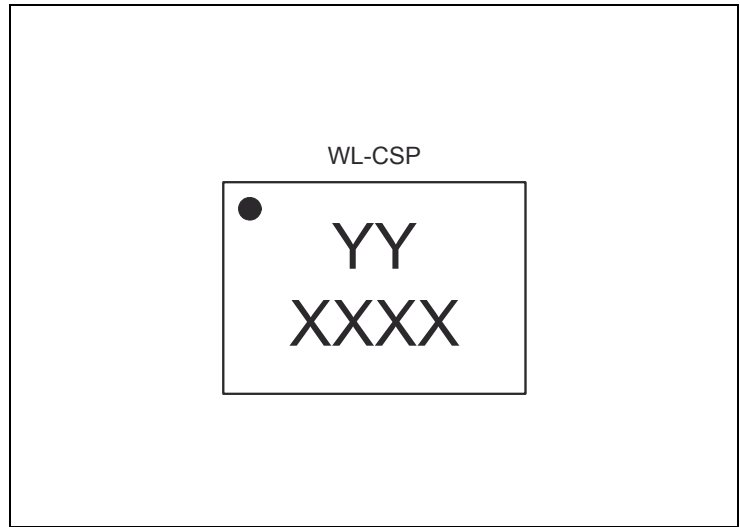

Figure 21:
AS1111C Package Marking

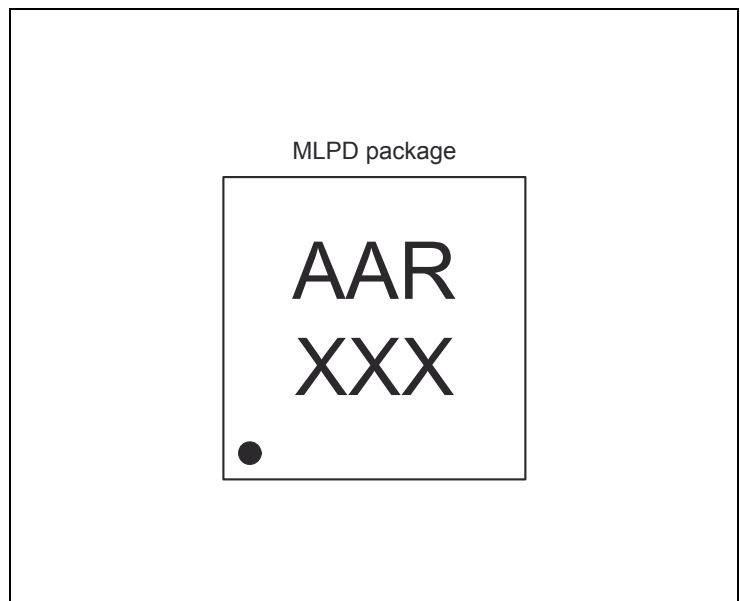

Figure 22:
AS1111 Package Code

YY	XXXX	AAR	XXX
Marking for WL-CSP	Tracecode for WL-CSP	Marking for MLPD	Tracecode for MLPD

Ordering & Contact Information

Figure 23:
Ordering Information

Ordering Code	Marking	Description	Delivery Form	Package
AS1111A-BWLT	CY	Dual LED driver with enable and 80mA LED current per channel	Tape & Reel	6-pin WL-CSP 0.4mm pitch
AS1111B-BWLT	CZ	Triple LED driver with enable and 40mA LED current per channel	Tape & Reel	6-pin WL-CSP 0.4mm pitch
AS1111C-BDFT	AAR	Quad LED driver with enable and 40mA LED current per channel	Tape & Reel	MLPD-8lead (2mm x 2mm)

Buy our products or get free samples online at:

www.ams.com/ICdirect

Technical Support is available at:

www.ams.com/Technical-Support

Provide feedback about this document at:

www.ams.com/Document-Feedback

For further information and requests, e-mail us at:

ams_sales@ams.com

For sales offices, distributors and representatives, please visit:

www.ams.com/contact

Headquarters

ams AG
Tobelbaderstrasse 30
8141 Unterpremstaetten
Austria, Europe

Tel: +43 (0) 3136 500 0

Website: www.ams.com

RoHS Compliant & ams Green Statement

RoHS: The term RoHS compliant means that ams AG products fully comply with current RoHS directives. Our semiconductor products do not contain any chemicals for all 6 substance categories, including the requirement that lead not exceed 0.1% by weight in homogeneous materials. Where designed to be soldered at high temperatures, RoHS compliant products are suitable for use in specified lead-free processes.

ams Green (RoHS compliant and no Sb/Br): ams Green defines that in addition to RoHS compliance, our products are free of Bromine (Br) and Antimony (Sb) based flame retardants (Br or Sb do not exceed 0.1% by weight in homogeneous material).

Important Information: The information provided in this statement represents ams AG knowledge and belief as of the date that it is provided. ams AG bases its knowledge and belief on information provided by third parties, and makes no representation or warranty as to the accuracy of such information. Efforts are underway to better integrate information from third parties. ams AG has taken and continues to take reasonable steps to provide representative and accurate information but may not have conducted destructive testing or chemical analysis on incoming materials and chemicals. ams AG and ams AG suppliers consider certain information to be proprietary, and thus CAS numbers and other limited information may not be available for release.

Copyrights & Disclaimer

Copyright ams AG, Tobelbader Strasse 30, 8141 Unterpremstaetten, Austria-Europe. Trademarks Registered. All rights reserved. The material herein may not be reproduced, adapted, merged, translated, stored, or used without the prior written consent of the copyright owner.

Devices sold by ams AG are covered by the warranty and patent indemnification provisions appearing in its General Terms of Trade. ams AG makes no warranty, express, statutory, implied, or by description regarding the information set forth herein. ams AG reserves the right to change specifications and prices at any time and without notice. Therefore, prior to designing this product into a system, it is necessary to check with ams AG for current information. This product is intended for use in commercial applications. Applications requiring extended temperature range, unusual environmental requirements, or high reliability applications, such as military, medical life-support or life-sustaining equipment are specifically not recommended without additional processing by ams AG for each application. This product is provided by ams AG "AS IS" and any express or implied warranties, including, but not limited to the implied warranties of merchantability and fitness for a particular purpose are disclaimed.

ams AG shall not be liable to recipient or any third party for any damages, including but not limited to personal injury, property damage, loss of profits, loss of use, interruption of business or indirect, special, incidental or consequential damages, of any kind, in connection with or arising out of the furnishing, performance or use of the technical data herein. No obligation or liability to recipient or any third party shall arise or flow out of ams AG rendering of technical or other services.

Document Status

Document Status	Product Status	Definition
Product Preview	Pre-Development	Information in this datasheet is based on product ideas in the planning phase of development. All specifications are design goals without any warranty and are subject to change without notice
Preliminary Datasheet	Pre-Production	Information in this datasheet is based on products in the design, validation or qualification phase of development. The performance and parameters shown in this document are preliminary without any warranty and are subject to change without notice
Datasheet	Production	Information in this datasheet is based on products in ramp-up to full production or full production which conform to specifications in accordance with the terms of ams AG standard warranty as given in the General Terms of Trade
Datasheet (discontinued)	Discontinued	Information in this datasheet is based on products which conform to specifications in accordance with the terms of ams AG standard warranty as given in the General Terms of Trade, but these products have been superseded and should not be used for new designs

Revision Information

Changes from 1-01 (2013-Nov) to current revision 1-06 (2015-Apr-07)	Page
1-01 (2013-Nov) to 1-03 (2014-Dec-03)	
Content was updated to the latest ams design	
Updated Figure 3	3
1-03 (2014-Dec-03) to 1-04 (2015-Mar-20)	
Updated caption below Figure 3	3
Updated Figure 5	5
Updated Figure 11	9
Updated Figure 16 & Figure 17	12
1-04 (2015-Mar-20) to 1-05 (2015-Apr-06)	
Updated Figure 5	5
Updated Figures 16 & 17	12
1-05 (2015-Apr-06) to 1-06 (2015-Apr-07)	
Updated text under General Description	1

Note(s) and/or Footnote(s):

1. Page and figure numbers for the previous version may differ from page and figure numbers in the current revision.
2. Correction of typographical errors is not explicitly mentioned.

Content Guide

1	General Description
1	Key Benefits & Features
2	Applications
2	Block Diagram
3	Pin Assignment
3	Pin Description
4	Absolute Maximum Ratings
6	Electrical Characteristics
8	Typical Operating Characteristics
13	Detailed Description
13	Setting of the LED Current
14	Package Drawings & Markings
17	Ordering & Contact Information
18	RoHS Compliant & ams Green Statement
19	Copyrights & Disclaimer
20	Document Status
21	Revision Information