

110V LED Controller with Spread Spectrum Frequency Modulation

FEATURES

- **3000:1 True Color PWM™ Dimming**
- **Wide Input Voltage Range: 4.5V to 110V**
- **Input and Output Current Reporting**
- **PMOS Switch Driver for PWM and Output Disconnect**
- **Internal Spread Spectrum Frequency Modulation**
- $\pm 2\%$ Constant Voltage Regulation
- $\pm 3\%$ Constant Current Regulation: $0V \leq V_{OUT} \leq 110V$
- Programmable Input Current limit
- CTRL Inputs Linearly Adjust LED Current
- Adjustable Frequency: 100kHz to 1MHz
- Programmable Open LED Protection with $\overline{\text{OPENLED}}$ Flag
- Short-Circuit Protection and $\overline{\text{SHORTLED}}$ Flag
- Programmable Undervoltage Lockout with Hysteresis
- Soft-Start with Programmable Fault Restart Timer
- C/10 Detection for Battery Charging
- Available in 28-Lead TSSOP Package
- AEC-Q100 Qualified for Automotive Applications

APPLICATIONS

- High Power LED, High Voltage LED
- Battery Chargers
- Accurate Current Limited Voltage Regulators

DESCRIPTION

The **LT[®]3795** is a DC/DC controller designed to regulate a constant-current or constant-voltage and is ideal for driving LEDs. It drives a low side external N-channel power MOSFET from an internal regulated 7.7V supply. The fixed frequency and current mode architecture result in stable operation over a wide range of supply and output voltages. Spread spectrum frequency modulation (SSFM) can be activated for improved electromagnetic compatibility (EMC) performance. The ground referred voltage FB pin serves as the input for several LED protection features, and also allows the converter to operate as a constant-voltage source. The maximum output current is set by an external resistor, and the output current amplifier has a rail-to-rail common mode range. The LT3795 also includes a separate input current sensing amplifier that is used to limit input current. The TG pin inverts and level shifts the PWM signal to drive the gate of the external PMOS. The PWM input provides LED dimming ratios of up to 3000:1, and the CTRL inputs provide additional analog dimming capability.

All registered trademarks and trademarks are the property of their respective owners. Protected by U.S. Patents, including 7199560, 7321203, 7746300.

TYPICAL APPLICATION

Short-Circuit Robust Boost LED Driver with Spread Spectrum Frequency Modulation

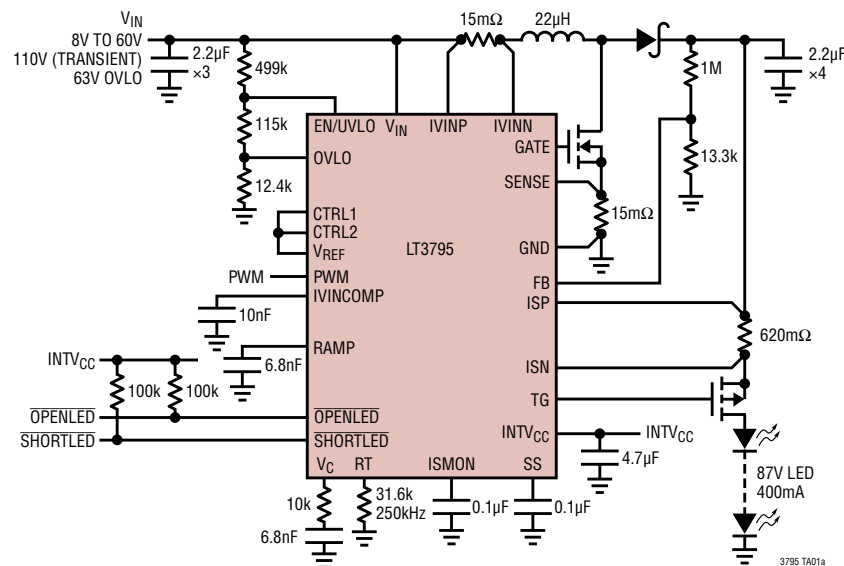

Efficiency vs V_{IN}

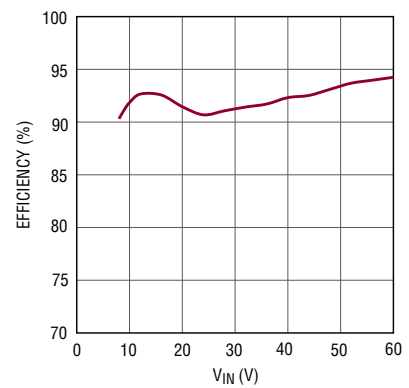

LT3795

ABSOLUTE MAXIMUM RATINGS

(Note 1)

V_{IN}	110V
EN/UVLO	110V
ISP, ISN	110V
TG, GATE	Note 2
IVINP, IVINN	110V
$V_{IN} - IVINN$	-0.3V to 4V
$INTV_{CC}$ (Note 3)	8.6V, $V_{IN} + 0.3V$
PWM, SHORTLED, OPENLED	12V
FB, RAMP, OVLO	8V
CTRL1, CTRL2	15V
SENSE	0.5V
ISMON, IVINCOMP	5V
V_C , V_{REF} , SS	3V
RT	2V
Operating Junction Temperature Range (Note 4)	
LT3795E/LT3795I	-40 to 125°C
LT3795H	-40 to 150°C
Storage Temperature Range	-65 to 150°C

PIN CONFIGURATION

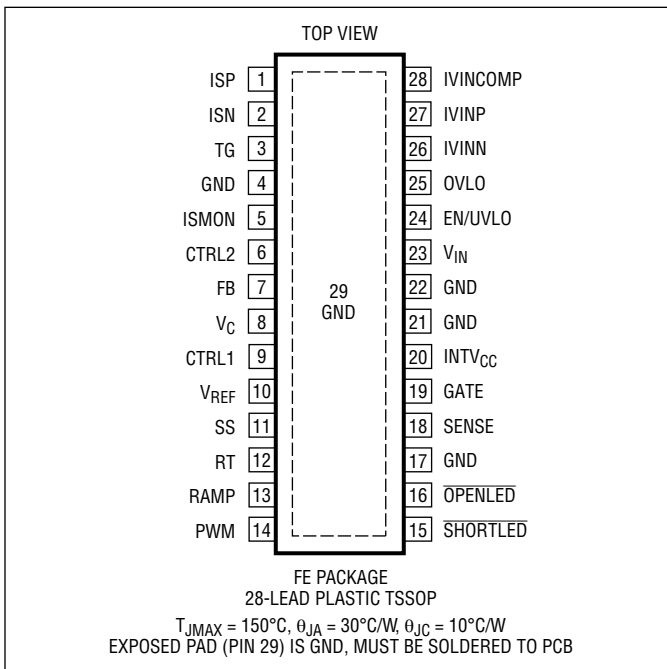

ORDER INFORMATION

LEAD FREE FINISH	TAPE AND REEL	PART MARKING*	PACKAGE DESCRIPTION	TEMPERATURE RANGE
LT3795EFE#PBF	LT3795EFE#TRPBF	LT3795FE	28-Lead Plastic TSSOP	-40°C to 125°C
LT3795IFE#PBF	LT3795IFE#TRPBF	LT3795FE	28-Lead Plastic TSSOP	-40°C to 125°C
LT3795HFE#PBF	LT3795HFE#TRPBF	LT3795FE	28-Lead Plastic TSSOP	-40°C to 150°C
AUTOMOTIVE PRODUCTS**				
LT3795EFE#WPBF	LT3795EFE#WTRPBF	LT3795FE	28-Lead Plastic TSSOP	-40°C to 125°C
LT3795IFE#WPBF	LT3795IFE#WTRPBF	LT3795FE	28-Lead Plastic TSSOP	-40°C to 125°C
LT3795HFE#WPBF	LT3795HFE#WTRPBF	LT3795FE	28-Lead Plastic TSSOP	-40°C to 150°C

Contact the factory for parts specified with wider operating temperature ranges. *The temperature grade is identified by a label on the shipping container.

Tape and reel specifications. Some packages are available in 500 unit reels through designated sales channels with #TRMPBF suffix.

**Versions of this part are available with controlled manufacturing to support the quality and reliability requirements of automotive applications. These models are designated with a #W suffix. Only the automotive grade products shown are available for use in automotive applications. Contact your local Analog Devices account representative for specific product ordering information and to obtain the specific Automotive Reliability reports for these models.

ELECTRICAL CHARACTERISTICS The ● denotes the specifications which apply over the full operating temperature range, otherwise specifications are at $T_A = 25^\circ\text{C}$, $V_{IN} = 24\text{V}$, $EN/UVLO = 24\text{V}$, $CTRL1 = CTRL2 = 2\text{V}$, $PWM = 5\text{V}$, unless otherwise noted.

PARAMETER	CONDITIONS		MIN	TYP	MAX	UNITS
V_{IN} Minimum Operating Voltage	V_{IN} Tied to $INTV_{CC}$				4.5	V
V_{IN} Shutdown I_Q	$EN/UVLO = 0\text{V}$, $PWM = 0\text{V}$ $EN/UVLO = 1.15\text{V}$, $PWM = 0\text{V}$				10 22	μA μA
V_{IN} Operating I_Q (Not Switching)	$R_T = 82.5\text{k}$ to GND, $FB = 1.5\text{V}$			2.9	3.5	mA
V_{REF} Voltage	$-100\mu\text{A} \leq I_{REF} \leq 10\mu\text{A}$	●	1.97	2.015	2.06	V
V_{REF} Pin Line Regulation	$4.5\text{V} < V_{IN} < 110\text{V}$			1.5		m%/V
V_{REF} Pin Load Regulation	$-100\mu\text{A} \leq I_{REF} \leq 0\mu\text{A}$			10		m%/ μA
SENSE Current Limit Threshold		●	100	117	125	mV
SENSE Input Bias Current	Current Out of Pin			65		μA
SS Sourcing Current	$SS = 0\text{V}$			28		μA
SS Sinking Current	$ISP - ISN = 1\text{V}$, $SS = 2\text{V}$			2.8		μA
Error Amplifier						
Full Scale LED Current Sense Threshold ($V_{(ISP-ISN)}$)	$ISP = 48\text{V}$, $CTRL1 \geq 1.2\text{V}$, $CTRL2 \geq 1.2\text{V}$ $ISP = 0\text{V}$, $CTRL1 \geq 1.2\text{V}$, $CTRL2 \geq 1.2\text{V}$	● ●	243 243	250 250	257 257	mV mV
9/10th LED Current Sense Threshold ($V_{(ISP-ISN)}$)	$ISP = 48\text{V}$, $CTRL1 = 1\text{V}$, $CTRL2 = 1.2\text{V}$ $ISP = 0\text{V}$, $CTRL1 = 1\text{V}$, $CTRL2 = 1.2\text{V}$	● ●	220 220	225 225	230 230	mV mV
1/2 LED Current Sense Threshold ($V_{(ISP-ISN)}$)	$ISP = 48\text{V}$, $CTRL1 = 0.6\text{V}$, $CTRL2 = 1.2\text{V}$ $ISP = 0\text{V}$, $CTRL1 = 0.6\text{V}$, $CTRL2 = 1.2\text{V}$	● ●	119 119	125 125	130 130	mV mV
1/10th LED Current Sense Threshold ($V_{(ISP-ISN)}$)	$ISP = 48\text{V}$, $CTRL1 = 0.2\text{V}$, $CTRL2 = 1.2\text{V}$ $ISP = 0\text{V}$, $CTRL1 = 0.2\text{V}$, $CTRL2 = 1.2\text{V}$	● ●	16 16	25 25	32 32	mV mV
ISP/ISN Current Monitor Voltage (V_{ISMON})	$V_{(ISP-ISN)} = 250\text{mV}$, $ISP = 48\text{V}$, $-50\mu\text{A} \leq I_{ISMON} \leq 0\mu\text{A}$ $V_{(ISP-ISN)} = 250\text{mV}$, $ISP = 0\text{V}$, $-50\mu\text{A} \leq I_{ISMON} \leq 0\mu\text{A}$	● ●	0.96 0.96	1 1	1.04 1.04	V V
ISP/ISN Overcurrent Protection Threshold ($V_{(ISP-ISN)}$)	$ISN = 48\text{V}$ $ISN = 0\text{V}$	● ●	360 360	375 375	390 390	mV mV
CTRL1, CTRL2 Input Bias Current	Current Out of Pin, CTRL = 1V			50	200	nA
ISP/ISN Current Sense Amplifier Input Common Mode Range			0		110	V
ISP/ISN Input Current Bias Current (Combined)	$PWM = 5\text{V}$ (Active), $ISP = 48\text{V}$ $PWM = 0\text{V}$ (Standby), $ISP = 48\text{V}$			700 0	0.1	μA μA
ISP/ISN Current Sense Amplifier g_m	$V_{(ISP-ISN)} = 250\text{mV}$			350		μS
V_C Output Impedance				2000		k Ω
V_C Standby Input Bias Current	$PWM = 0\text{V}$		-20		20	nA
FB Regulation Voltage (V_{FB})	$ISP = ISN = 48\text{V}$ $ISP = ISN = 48\text{V}$	●	1.230 1.238	1.250 1.250	1.270 1.264	V V
FB Amplifier g_m				600		μS
FB Pin Input Bias Current	Current Out of Pin, $FB = V_{FB}$			40	200	nA
FB Open LED Threshold	$\overline{\text{OPENLED}}$ Falling, $ISP = ISN = 48\text{V}$		$V_{FB} - 62\text{mV}$	$V_{FB} - 52\text{mV}$	$V_{FB} - 42\text{mV}$	V
C/10 Comparator Threshold ($V_{(ISP-ISN)}$)	$\overline{\text{OPENLED}}$ Falling, $FB = 1.25\text{V}$, $ISP = 48\text{V}$ $\overline{\text{OPENLED}}$ Falling, $FB = 1.25\text{V}$, $ISN = 0\text{V}$			25 25		mV mV
FB Overvoltage Threshold	TG Rising		$V_{FB} + 35\text{mV}$	$V_{FB} + 50\text{mV}$	$V_{FB} + 60\text{mV}$	V
V_C Current Mode Gain ($\Delta V_{VC}/\Delta V_{SENSE}$)				4.2		V/V
FB SHORTLED Threshold	SHORTLED Falling	●		300	350	mV
V_C Pin Source Current	$V_C = 1.2\text{V}$			10		μA
V_C Pin Sink Current	$V_C = 1.2\text{V}$, $FB = 1.4\text{V}$			30		μA

ELECTRICAL CHARACTERISTICS

The ● denotes the specifications which apply over the full operating temperature range, otherwise specifications are at $T_A = 25^\circ\text{C}$, $V_{IN} = 24\text{V}$, $\text{EN}/\text{UVLO} = 24\text{V}$, $\text{CTRL1} = \text{CTRL2} = 2\text{V}$, $\text{PWM} = 5\text{V}$, unless otherwise noted.

PARAMETER	CONDITIONS		MIN	TYP	MAX	UNITS
Input Current Sense Amplifier						
Input Current Sense Amplifier Input Voltage Common Range (V_{IVINP}/V_{IVINN})		●	2.5		110	V
Input Current Sense Threshold ($V_{IVINP} - V_{IVINN}$)	$V_{IVINP} = 48\text{V}$, $V_{IVINN} = 48\text{V}$	●	57	60	63	mV
Input Current Monitor V($IVINCOMP$)	$V_{IVINP} - V_{IVINN} = 50\text{mV}$, $V_{IVINN} = 48\text{V}$	●	0.94	1	1.06	V
Input Bias Current (I_{IVINN})	$V_{IVINP} - V_{IVINN} = 50\text{mV}$, $V_{IVINN} = 48\text{V}$			100	1000	nA
Input Current Sense Amplifier g_m	$V_{IVINP} - V_{IVINN} = 60\text{mV}$, $V_{IVINN} = 48\text{V}$			3400		μS
Input Step Response (to 50% of Output Step)	$\Delta V_{\text{SENSE}} = 60\text{mV}$ Step, $V_{IVINN} = 48\text{V}$			1		μS
$IVINCOMP$ Pin Resistance to GND	$V_{IVINN} = 48\text{V}$			15		$\text{k}\Omega$
Linear Regulator						
$INTV_{CC}$ Regulation Voltage		●	7.4	7.7	8	V
Dropout ($V_{IN} - INTV_{CC}$)	$I_{INTV_{CC}} = -10\text{mA}$, $V_{IN} = 4.5\text{V}$			550		mV
$INTV_{CC}$ Current Limit	$V_{IN} = 110\text{V}$, $INTV_{CC} = 6\text{V}$ $V_{IN} = 12\text{V}$, $INTV_{CC} = 6\text{V}$		18 85			 mA mA
$INTV_{CC}$ Shutdown Bias Current if Externally Driven to 7V	$\text{EN}/\text{UVLO} = 0\text{V}$, $INTV_{CC} = 7\text{V}$			13	17	μA
$INTV_{CC}$ Undervoltage Lockout			3.8	4	4.1	V
$INTV_{CC}$ Undervoltage Lockout Hysteresis				200		mV
Oscillator						
Switching Frequency	$R_T = 82.5\text{k}$ $R_T = 19.6\text{k}$ $R_T = 6.65\text{k}$	● ● ●	85 340 900	105 400 1000	125 480 1150	 kHz kHz kHz
Minimum Off-Time	(Note 5)			160		ns
Minimum On-Time	(Note 5)			210		ns
Switching Frequency Modulation	$V_{\text{RAMP}} = 2\text{V}$			70		%
RAMP Input Low Threshold				1		V
RAMP Input High Threshold				2		V
RAMP Pin Source Current	$\text{RAMP} = 0.4\text{V}$			12		μA
RAMP Pin Sink Current	$\text{RAMP} = 1.6\text{V}$			12		μA
LOGIC Input/Outputs						
PWM Input Threshold Rising		●	0.96	1	1.04	V
PWM Pin Bias Current				10		μA
EN/UVLO Threshold Voltage Falling		●	1.185	1.220	1.25	V
EN/UVLO Rising Hysteresis				20		mV
EN/UVLO Input Low Voltage	I_{VIN} Drops Below $10\mu\text{A}$		0.4			V
EN/UVLO Pin Bias Current Low	$\text{EN}/\text{UVLO} = 1.15\text{V}$		2.5	3	3.8	μA
EN/UVLO Pin Bias Current High	$\text{EN}/\text{UVLO} = 1.30\text{V}$			10	100	nA
$\overline{\text{OPENLED}}$ OUTPUT Low	$I_{\overline{\text{OPENLED}}} = 0.5\text{mA}$				300	mV
$\overline{\text{SHORTLED}}$ OUTPUT Low	$I_{\overline{\text{SHORTLED}}} = 0.5\text{mA}$				300	mV
OVLO Threshold Voltage Rising		●	1.215	1.25	1.28	V
OVLO Falling Hysteresis				28		mV
OVLO Pin Input Current				150		nA

ELECTRICAL CHARACTERISTICS The ● denotes the specifications which apply over the full operating temperature range, otherwise specifications are at $T_A = 25^\circ\text{C}$, $V_{IN} = 24\text{V}$, $EN/UVLO = 24\text{V}$, $CTRL1 = CTRL2 = 2\text{V}$, $PWM = 5\text{V}$, unless otherwise noted.

PARAMETER	CONDITIONS	MIN	TYP	MAX	UNITS
Gate Driver					
t_r NMOS GATE Driver Output Rise Time	$C_L = 3300\text{pF}$, 10% to 90%		20		ns
t_f NMOS GATE Driver Output Fall Time	$C_L = 3300\text{pF}$, 10% to 90%		18		ns
NMOS GATE Output Low (V_{OL})				0.05	V
NMOS GATE Output High (V_{OH})		$INTV_{CC} - 0.05$			V
t_r Top GATE Driver Output Rise Time	$C_L = 300\text{pF}$		50		ns
t_f Top GATE Driver Output Fall Time	$C_L = 300\text{pF}$		100		ns
Top Gate On Voltage ($V_{ISP} - V_{TG}$)	ISP = 48V		7	8	V
Top Gate Off Voltage ($V_{ISP} - V_{TG}$)	PWM = 0V, ISP = 48V		0	0.3	V

Note 1: Stresses beyond those listed under Absolute Maximum Ratings may cause permanent damage to the device. Exposure to any Absolute Maximum Rating condition for extended periods may affect device reliability and lifetime.

Note 2: Do not apply a positive or negative voltage source to TG and GATE pins, otherwise permanent damage may occur.

Note 3: Operating maximum for $INTV_{CC}$ is 8V.

Note 4: The LT3795E is guaranteed to meet specified performance from 0°C to 125°C . Specifications over the -40°C to 125°C operating junction

temperature range are assured by design, characterization and correlation with statistical process controls. The LT3795I is guaranteed to meet performance specifications over the -40°C to 125°C operating junction temperature range. The LT3795H is guaranteed over the full -40°C to 150°C operating junction temperature range. High junction temperatures degrade operating lifetimes. Operating lifetime is derated at junction temperatures greater than 125°C .

Note 5: See Duty Cycle Considerations in the Applications Information section.

TYPICAL PERFORMANCE CHARACTERISTICS

$T_A = 25^\circ\text{C}$, unless otherwise noted.

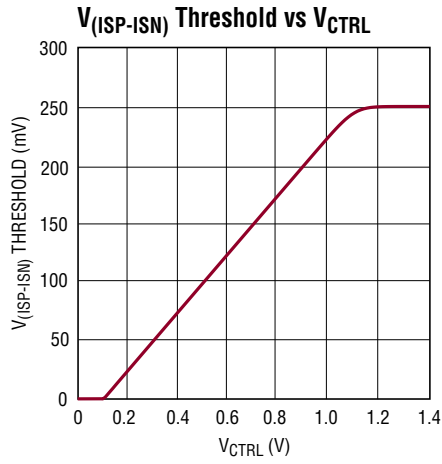

3795 G01

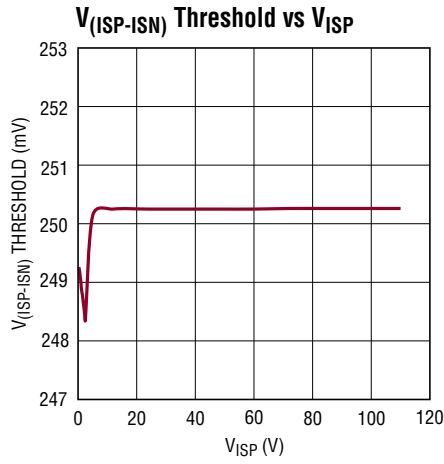

3795 G02

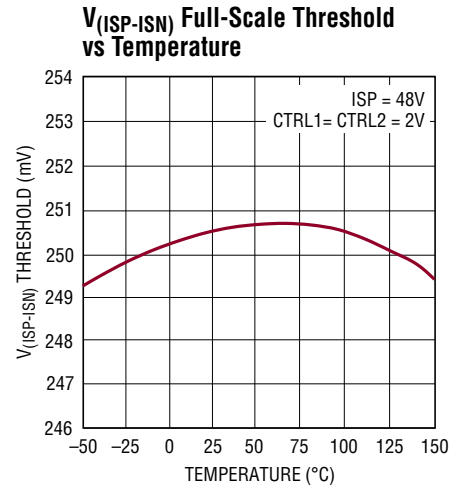

3795 G03

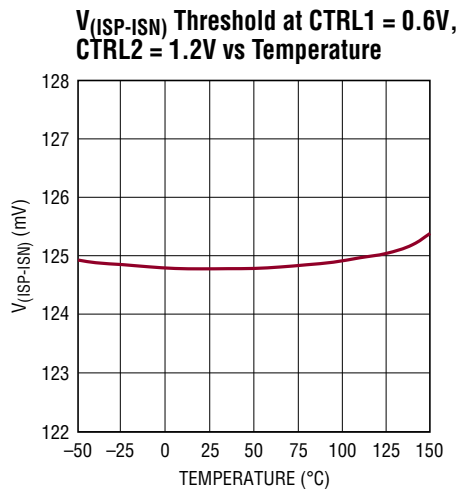

3795 G03a

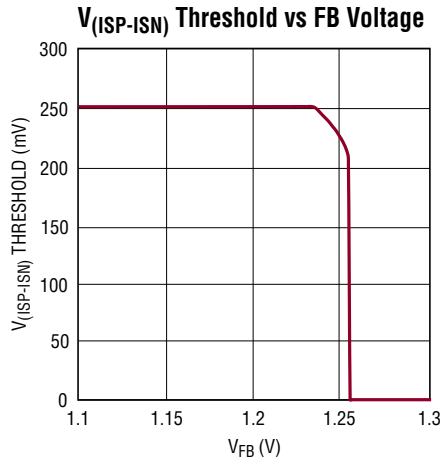

3795 G04

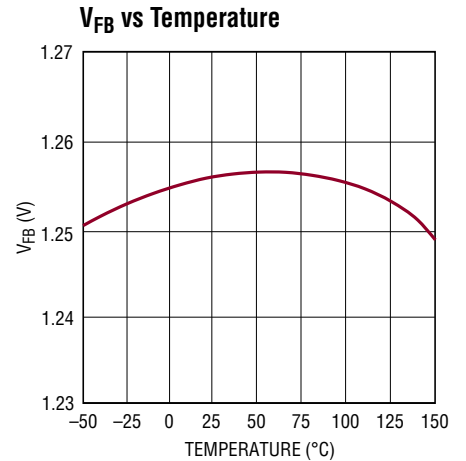

3795 G05

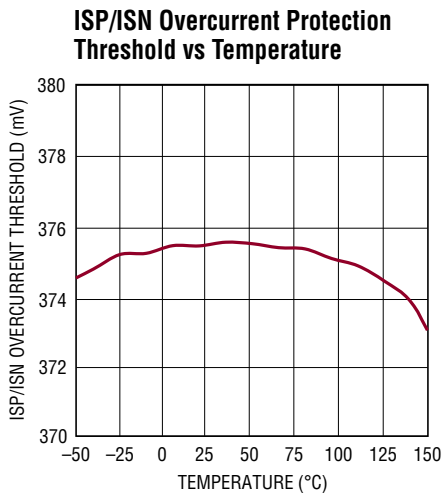

3795 G06

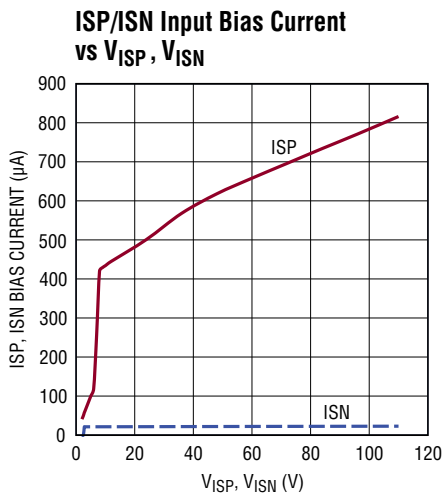

3795 G07

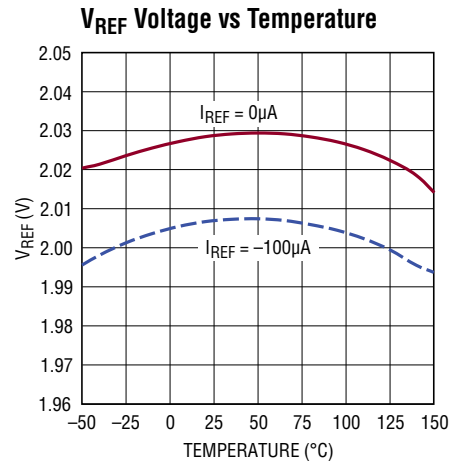

3795 G08

TYPICAL PERFORMANCE CHARACTERISTICS

$T_A = 25^\circ\text{C}$, unless otherwise noted.

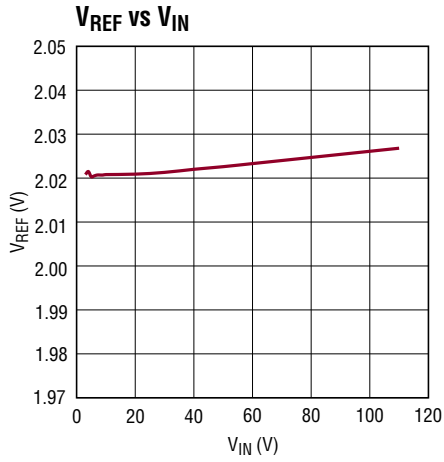

3795 G09

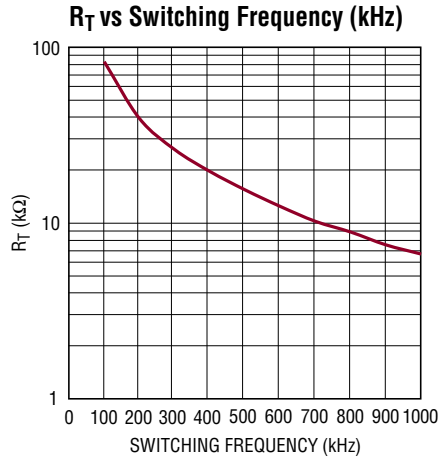

3795 G10

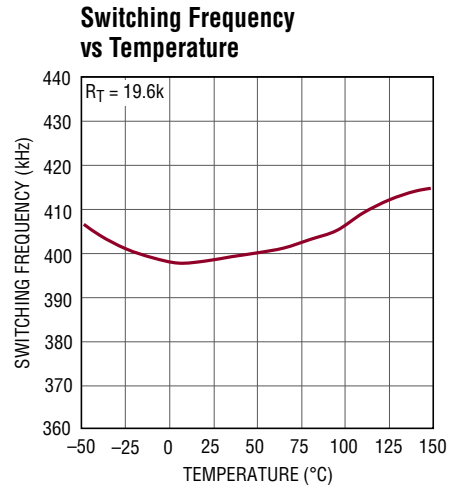

3795 G11

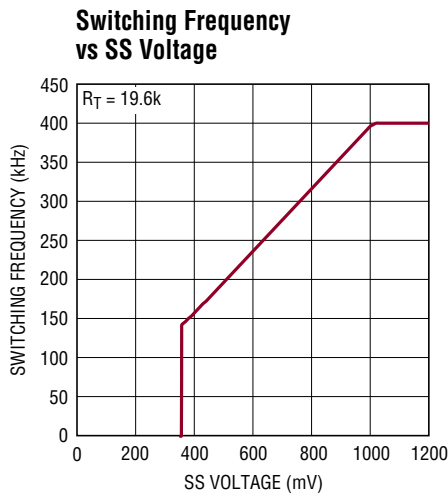

3795 G11a

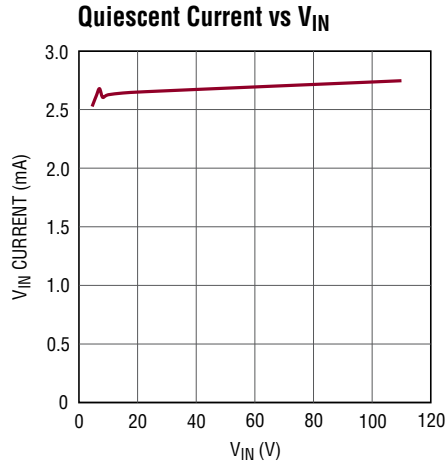

3795 G12

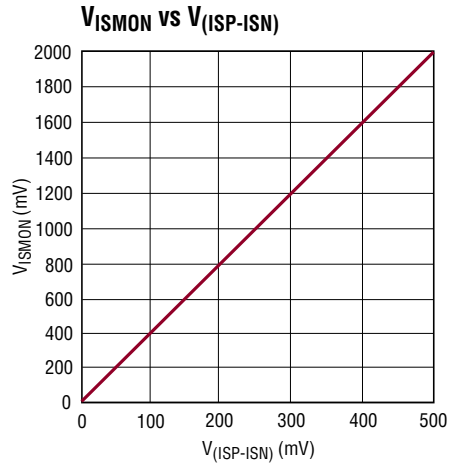

3795 G13

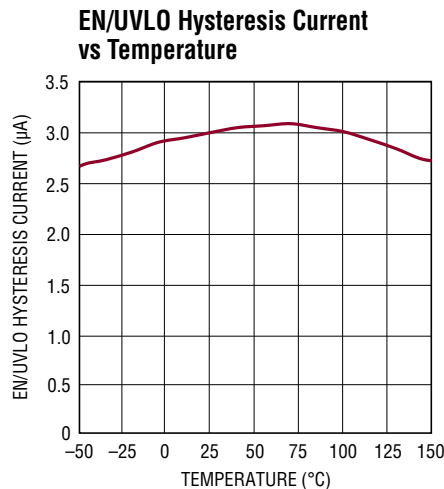

3795 G14

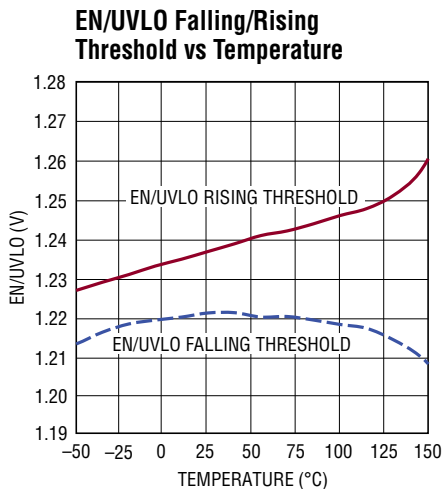

3795 G15

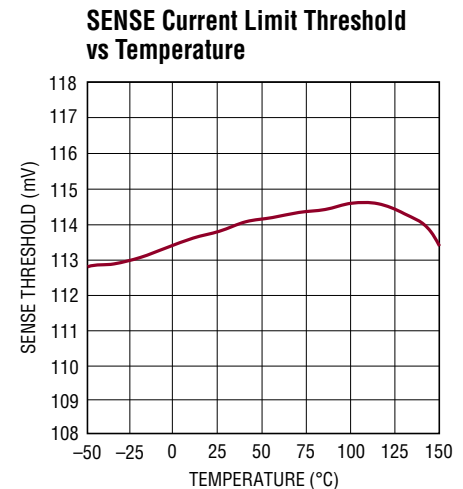

3795 G16

TYPICAL PERFORMANCE CHARACTERISTICS

$T_A = 25^\circ\text{C}$, unless otherwise noted.

SENSE Current Limit Threshold vs Duty Cycle

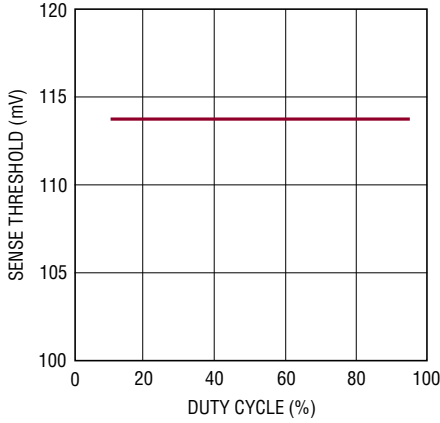

3795 G17

INTV_{CC} Current Limit vs V_{IN}

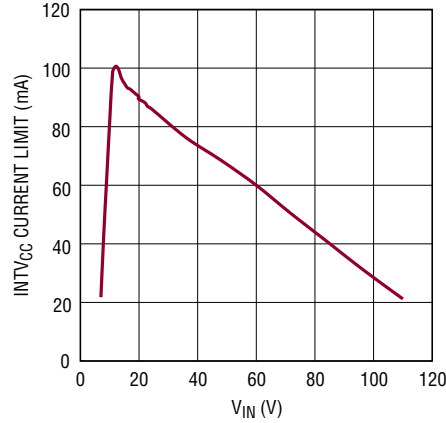

3795 G18

INTV_{CC} Current Limit vs Temperature

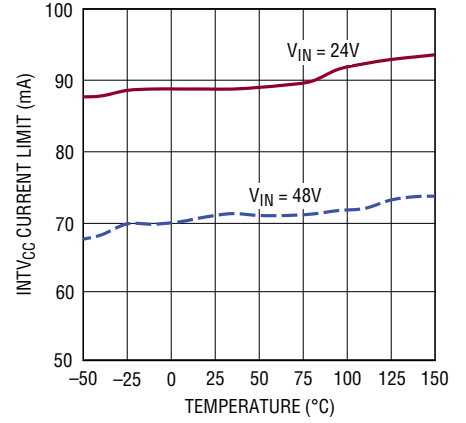

3795 G19

INTV_{CC} vs V_{IN}

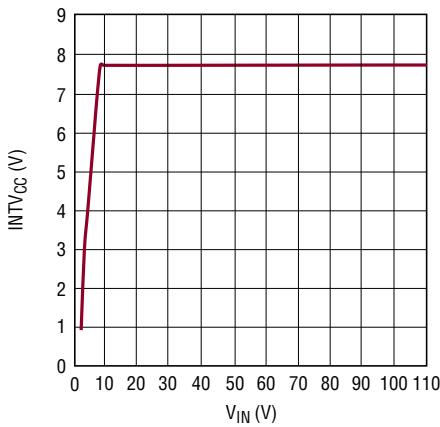

3795 G20

INTV_{CC} Dropout Voltage vs Current, Temperature

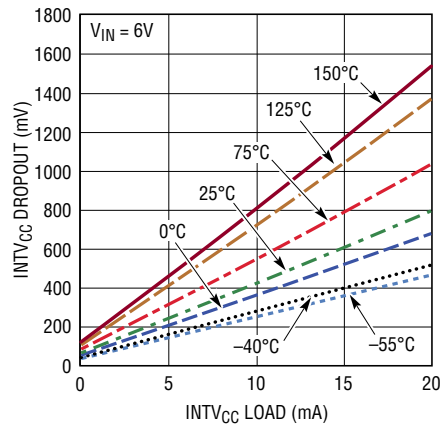

3795 G21

INTV_{CC} vs Temperature

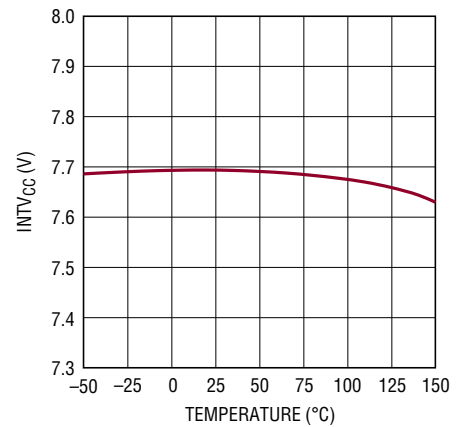

3795 G22

V_(IVINP-IVINN) Threshold vs Temperature

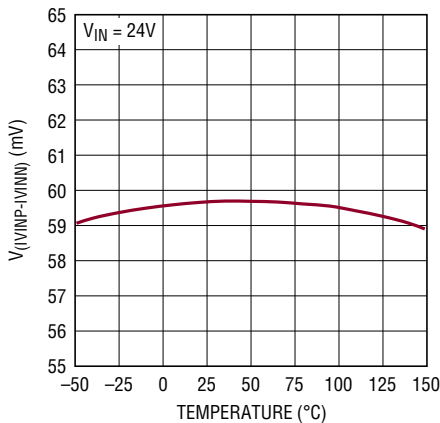

3795 G23

V_(IVINP-IVINN) Threshold vs V_{IN}

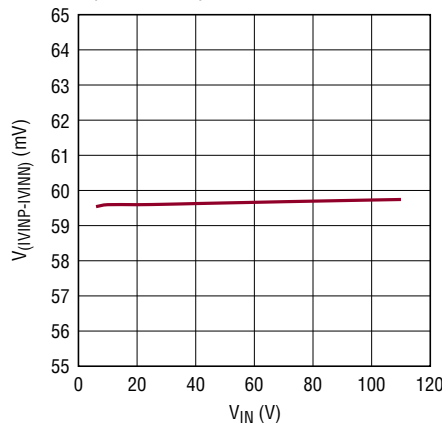

3795 G24

V_{IVINCOMP} vs V_(IVINP-IVINN)

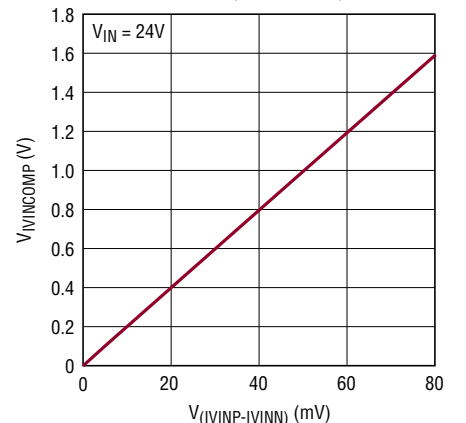

3795 G25

TYPICAL PERFORMANCE CHARACTERISTICS

$T_A = 25^\circ\text{C}$, unless otherwise noted.

RAMP Pin Sourcing and Sinking Current vs Temperature

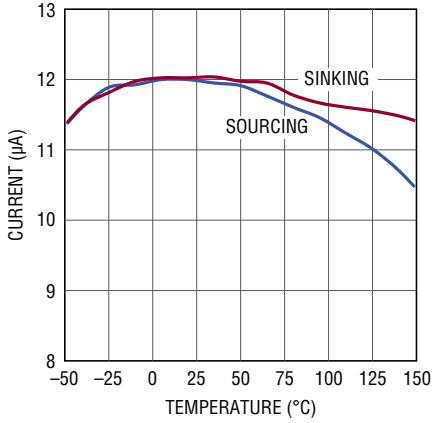

3795 G26

NMOS Gate Rise/Fall Time vs Capacitance

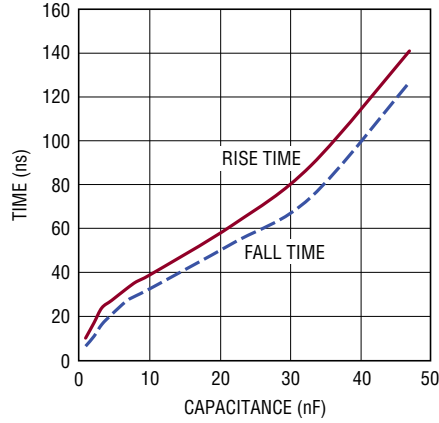

3795 G27

Top Gate (PMOS) Rise/Fall Time vs Capacitance

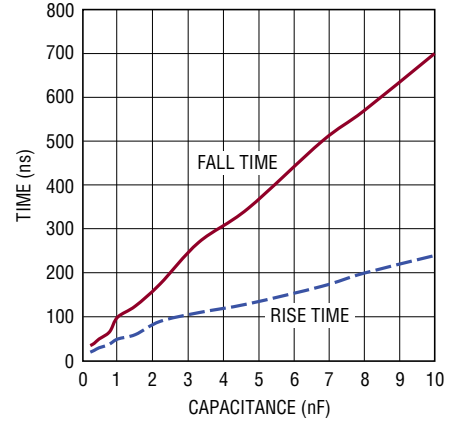

3795 G28

Top Gate Driver Rising Edge

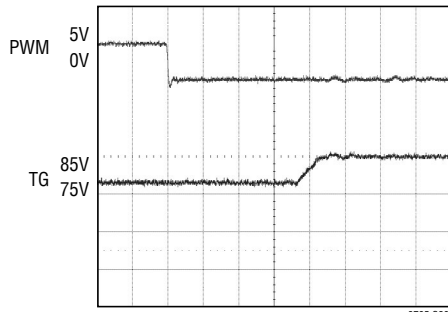

3795 G29

PMOS VISHAY SILICONIX Si7113DN

Top Gate Driver Falling Edge

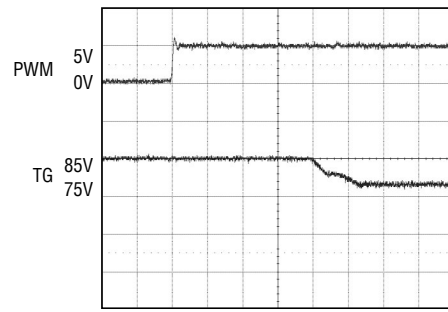

3795 G30

PMOS VISHAY SILICONIX Si7113DN

PIN FUNCTIONS

ISP (Pin 1): Connection Point for the Positive Terminal of the Current Feedback Resistor (R_{LED}). Also serves as positive rail for TG pin driver.

ISN (Pin 2): Connection Point for the Negative Terminal of the Current Feedback Resistor (R_{LED}).

TG (Pin 3): Top Gate Driver Output. An inverted PWM signal drives the gate of a series PMOS device between V_{ISP} and $(V_{ISP} - 7V)$ if $V_{ISP} > 7V$. An internal 7V clamp protects the PMOS gate by limiting VGS. Leave TG unconnected if not used.

GND (Pins 4, 17, 21, 22, Exposed Pad Pin 29): Ground. These pins also serve as current sense input for control loop, sensing the negative terminal of the current sense resistor in the source of the N-channel MOSFET. Solder the exposed pad directly to the ground plane.

ISMON (Pin 5): ISP/ISN Current Report Pin. The LED current sensed by ISP/ISN inputs is reported as $V_{ISMON} = I_{LED} \cdot R_{LED} \cdot 4$. Leave ISMON pin unconnected if not used. When PWM is low, ISMON is driven to ground. Bypass with a 47nF capacitor or higher if needed.

CTRL2 (Pin 6): Current Sense Threshold Adjustment Pin 2. This pin has identical functions as CTRL1. The $V_{(ISP-ISN)}$ threshold is regulated by the internal 1.1V reference voltage, CTRL1 or CTRL2. Whichever is the lowest takes precedence. Regulating threshold $V_{(ISP-ISN)}$ is $0.25 \cdot V_{CTRLX}$ less an offset for $0.1V < V_{CTRLX} < 1V$. For $V_{CTRLX} > 1.2V$ the current sense threshold is constant at the full-scale value of 250mV. For $1V < V_{CTRLX} < 1.2V$, the dependence of the current sense threshold upon V_{CTRLX} transitions from a linear function to a constant value, reaching 98% of full-scale value by $V_{CTRLX} = 1.1V$. Connect CTRL1 and CTRL2 to V_{REF} for the 250mV default current threshold. Do not leave this pin open. Connect either CTRL pin to GND for zero LED current.

FB (Pin 7): Voltage Loop Feedback Pin. FB is intended for constant-voltage regulation or for LED protection/open LED detection. The internal transconductance amplifier with output V_C regulates FB to 1.25V (nominal) through the DC/DC converter. If the FB input is regulating the loop, and $V_{(ISP-ISN)}$ is less than 25mV (typical), the OPENLED pull-down is asserted. This action may signal an open LED fault. If FB is driven above the 1.3V (by an external power

supply spike, for example), the GATE pin is pulled low to turn off the external N-channel MOSFET and the TG pin is driven high to protect the LEDs from an overcurrent event. Do not tie this pin to GND as the SHORTLED will be asserted and the part will be shut down.

V_C (Pin 8): Transconductance Error Amplifier Output Pin. Used to stabilize the control loop with an RC network. This pin is high impedance when PWM is low, a feature that stores the demand current state variable for the next PWM high transition. Connect a capacitor between this pin and GND; a resistor in series with the capacitor is recommended for fast transient response. Do not leave this pin open.

CTRL1 (Pin 9): Current Sense Threshold Adjustment Pin 1. This pin has an identical function as CTRL2. Please refer to the CTRL2 pin description.

V_{REF} (Pin 10): Voltage Reference Output Pin. Typically 2.015V. This pin drives a resistor divider for the CTRL pins, either for analog dimming or for temperature limit/compensation of the LED load. It can supply up to 100 μ A.

SS (Pin 11): Soft-Start Pin. This pin modulates oscillator frequency and compensation pin voltage (V_C) clamp. The soft-start interval is set with an external capacitor. The pin has a 28 μ A (typical) pull-up current source to an internal 2.5V rail. This pin can be used as fault timer. Provided the SS pin has exceeded 1.7V to complete a blanking period at start-up, the pull-up current source is disabled and a 2.8 μ A pull-down current enabled when any one of the following fault conditions happen:

1. LED overcurrent ($ISP-ISN > 0.375V$)
2. $INTV_{CC}$ undervoltage
3. Output short ($FB < 0.3V$ after start-up)
4. Thermal limit

The SS pin must be discharged below 0.2V to reinitiate a soft-start cycle. Switching is disabled until SS begins to recharge. It is important to select a capacitor large enough that FB can exceed 0.3V under normal load conditions before SS exceeds 1.7V. Do not leave this pin open.

RT (Pin 12): Switching Frequency Adjustment Pin. Set the frequency using a resistor to GND (for resistor values, see the Typical Performance curve or Table 2). Do not leave the RT pin open.

PIN FUNCTIONS

RAMP (Pin 13): The RAMP pin is used for spread spectrum frequency modulation. The internal switching frequency is spread out to 70% of the original value, where the modulation frequency is set by $12\mu\text{A}/(2 \cdot 1\text{V} \cdot C_{\text{RAMP}})$. If not used, tie this pin to GND.

PWM (Pin 14): PWM Input Signal Pin. A low signal turns off switching, idles the oscillator, disconnects the V_C pin from all internal loads, and drives TG to the ISP level. PWM has an internal 500k pull-down resistor. If not used, connect to V_{REF} .

SHORTLED (Pin 15): An open-collector pull-down on $\overline{\text{SHORTLED}}$ asserts when any of the following conditions happen:

1. $\text{FB} < 0.3\text{V}$ after SS pin reaches 1.7V at start-up.
2. LED overcurrent ($V_{(\text{ISP-ISN})} > 375\text{mV}$).

To function, the pin requires an external pull-up resistor. $\overline{\text{SHORTLED}}$ status is only updated during PWM high state and latched during PWM low state. $\overline{\text{SHORTLED}}$ remains asserted until the SS pin is discharged below 0.2V.

OPENLED (Pin 16): An open-collector pull-down on $\overline{\text{OPENLED}}$ asserts if the FB input is above 1.20V (typical), and $V_{(\text{ISP-ISN})}$ is less than 25mV (typical). To function, the pin requires an external pull-up resistor. $\overline{\text{OPENLED}}$ status is updated only during PWM high state and latched during PWM low state.

SENSE (Pin 18): The current sense input for the control loop. Kelvin connect this pin to the positive terminal of the switch current sense resistor, R_{SENSE} , in the source of the N-channel MOSFET. The negative terminal of the current sense resistor should be Kelvin connected to the GND plane of the IC.

GATE (Pin 19): N-Channel MOSFET Gate Driver Output. Switches between INTV_{CC} and GND. It is driven to GND during shutdown, fault or idle states.

INTV_{CC} (Pin 20): Regulated Supply for Internal Loads and GATE Driver. Supplied from V_{IN} and regulates to 7.7V (typical). INTV_{CC} must be bypassed with a 4.7 μF capacitor placed close to the pin. Connect INTV_{CC} directly to V_{IN} if V_{IN} is always less than or equal to 8V.

V_{IN} (Pin 23): Input Supply Pin. Must be locally bypassed with a 0.22 μF (or larger) capacitor placed close to the IC.

EN/UVLO (Pin 24): Enable and Undervoltage Lockout Pin. An accurate 1.22V falling threshold with externally programmable hysteresis detects when power is OK to enable switching. Rising hysteresis is generated by the external resistor divider and an accurate internal 3 μA pull-down current. Above the threshold, EN/UVLO input bias current is sub- μA . Below the falling threshold, a 3 μA pull-down current is enabled so the user can define the hysteresis with the external resistor selection. An undervoltage condition resets soft-start. Tie to 0.4V, or less, to disable the device.

OVLO (Pin 25): Input Overvoltage Lockout Pin. An accurate 1.25V rising threshold detects when power is OK to enable switching.

IVINN (Pin 26): Connection Point for the Negative Terminal of the Input Current Sense Resistor (R_{INSNS}). The input current can be programmed by $I_{\text{IN}} = 60\text{mV}/R_{\text{INSNS}}$.

IVINP (Pin 27): Connection Point for the Positive Terminal of the Input Current Sense Resistor.

IVINCOMP (Pin 28): Input Current Sense Amplifier Output Pin. The voltage at IVINCOMP pin is proportional to I_{IN} as $V_{\text{IVINCOMP}} = I_{\text{IN}} \cdot R_{\text{INSNS}} \cdot 20$. A 10nF or larger capacitor to GND is required at this pin to compensate the input current loop. Do not leave this pin open, and do not load this pin with a current.

BLOCK DIAGRAM

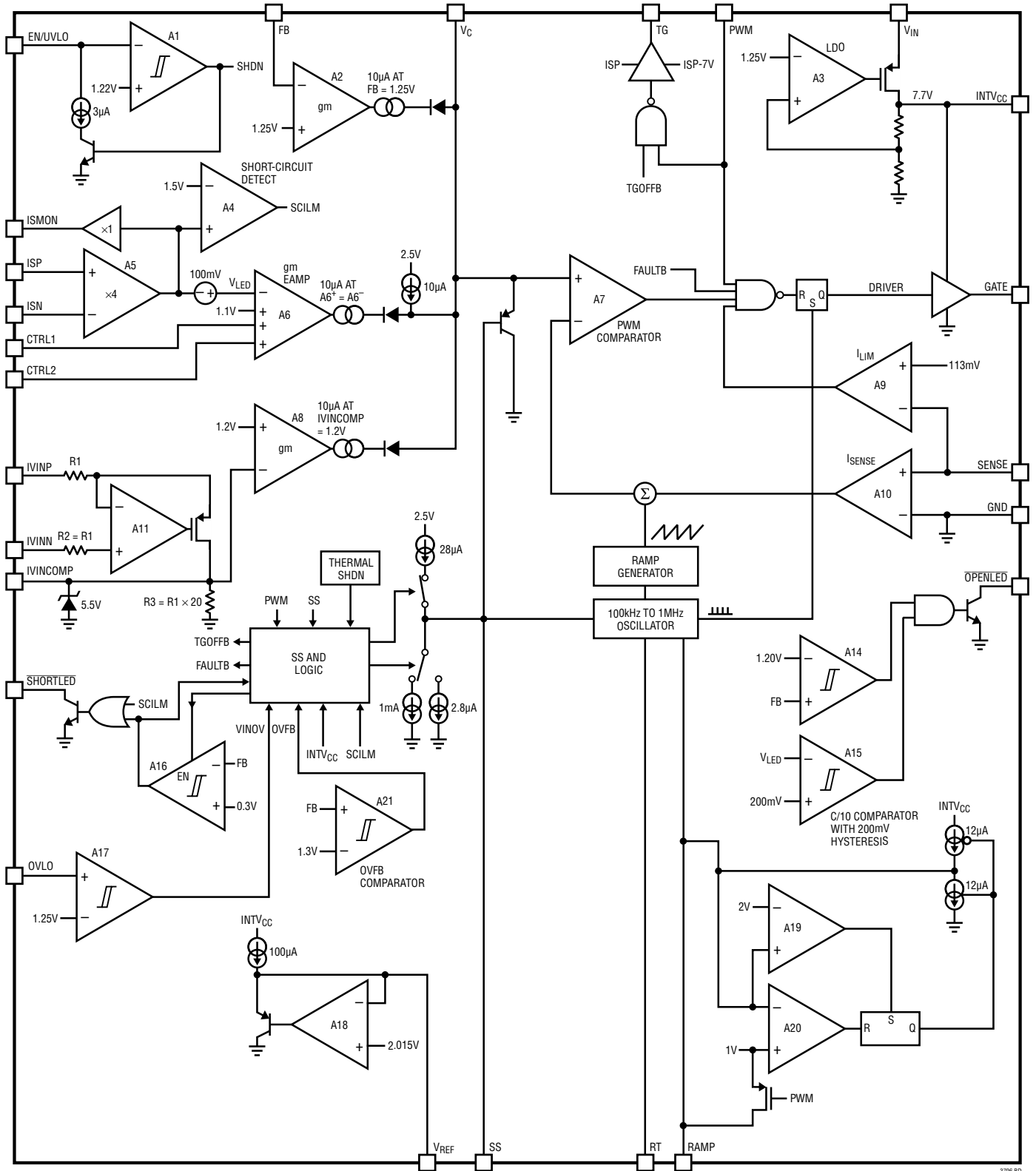

3795 80

OPERATION

The LT3795 is a constant-frequency, current mode controller with a low side NMOS gate driver. The operation of the LT3795 is best understood by referring to the Block Diagram of the IC. In normal operation, with the PWM pin low, the GATE pin is driven to GND, the TG pin is pulled high to ISP to turn off the PMOS disconnect switch, the V_C pin goes high impedance to store the previous switching state on the external compensation capacitor, and the ISP and ISN pin bias currents are reduced to leakage levels. When the PWM pin transitions high, the TG pin transitions low after a short delay. At the same time, the internal oscillator wakes up and generates a pulse to set the PWM latch, turning on the external power N-channel MOSFET switch (GATE goes high). A voltage input proportional to the switch current, sensed by an external current sense resistor between the SENSE and GND input pins, is added to a stabilizing slope compensation ramp and the resulting switch current sense signal is fed into the negative terminal of the PWM comparator. The current in the external inductor increases steadily during the time the switch is on. When the switch current sense voltage exceeds the output of the error amplifier, labeled V_C , the latch is reset and the switch is turned off. During the switch off phase, the inductor current decreases. At the completion of each oscillator cycle, internal signals such as slope compensation return to their starting points and a new cycle begins with the set pulse from the oscillator. Through this repetitive action, the PWM control algorithm establishes a switch duty cycle to regulate a current or voltage in the load. The V_C signal is integrated over many switching cycles and is an amplified version of the difference between the LED current sense voltage, measured between ISP and ISN, and the target difference voltage set by the CTRL1 or CTRL2 pin. In this manner, the error amplifier sets the correct peak switch current level to keep the LED current in regulation. If the error amplifier output increases, more current is demanded in the switch; if it decreases, less current is demanded. The switch current is monitored during the on phase and the voltage across

the SENSE pin is not allowed to exceed the current limit threshold of 113mV (typical). If the SENSE pin exceeds the current limit threshold, the SR latch is reset regardless of the output state of the PWM comparator. Likewise, any fault condition, i.e. FB overvoltage ($FB > 1.3V$), output short ($FB < 0.3V$) after start-up, input overvoltage ($OVLO > 1.25V$) LED overcurrent, or $INTV_{CC}$ undervoltage ($INTV_{CC} < 4V$), the GATE pin is pulled down to GND immediately.

In voltage feedback mode, the operation is similar to that described above, except the voltage at the V_C pin is set by the amplified difference of the internal reference of 1.25V (nominal) and the FB pin. If FB is lower than the reference voltage, the switch current increases; if FB is higher than the reference voltage, the switch demand current decreases. The LED current sense feedback interacts with the voltage feedback so that FB does not exceed the internal reference and the voltage between ISP and ISN does not exceed the threshold set by either of the CTRL pins. For accurate current or voltage regulation, it is necessary to be sure that under normal operating conditions, the appropriate loop is dominant. To deactivate the voltage loop entirely, FB can be set between 0.4V and 1V through a resistor network to V_{REF} pin. To deactivate the LED current loop entirely, the ISP and ISN should be tied together and CTRL1 and CTRL2 tied to V_{REF} .

Two LED specific functions featured on the LT3795 are controlled by the voltage feedback FB pin. First, when the FB pin exceeds a voltage 52mV lower (-4%) than the FB regulation voltage and $V_{(ISP-ISN)}$ is less than 25mV (typical), the pull-down driver on the OPENLED pin is activated. This function provides a status indicator that the load may be disconnected and the constant-voltage feedback loop is taking control of the switching regulator. When the FB pin drops below 0.3V after start-up, the SHORTLED pin is asserted by comparator A16. A blanking period occurs during start-up for the SHORTLED protection feature from the EN/UVLO toggle until the SS pin reaches 1.7V.

OPERATION

LT3795 features a PMOS disconnect switch driver. The PMOS disconnect switch can be used to improve the PWM dimming ratio, and operate as fault protection as well. Once a fault condition is detected, the TG pin is pulled high to turnoff the PMOS switch. The action isolates the LED array from the power path, preventing excessive current from damaging the LEDs.

A standalone input current sense amplifier is integrated in the LT3795. The input current sense amplifier A11 senses the input current and converts it to a voltage signal at the IVINCOMP pin. When the voltage potential at the IVINCOMP pin moves close to 1.2V, the amplifier A8 starts to interact with the V_C pin, and thus reduces the regulated LED current. In this way, the input current is limited.

APPLICATIONS INFORMATION

INTV_{CC} Regulator Bypassing and Operation

The INTV_{CC} pin requires a capacitor for stable operation and to store the charge for the large GATE switching currents. Choose a 10V rated low ESR, X7R or X5R ceramic capacitor for best performance. A 4.7μF ceramic capacitor is adequate for many applications. Place the capacitor close to the IC to minimize the trace length to the INTV_{CC} pin and also to the IC ground.

An internal current limit on the INTV_{CC} output protects the LT3795 from excessive on-chip power dissipation. The minimum value of this current limit should be considered when choosing the switching N-channel MOSFET and the operating frequency. I_{INTVCC} can be calculated from the following equation:

$$I_{INTVCC} = Q_G \cdot f_{OSC}$$

Careful choice of a lower Q_G MOSFET allows higher switching frequencies, leading to smaller magnetics. The INTV_{CC} pin has its own undervoltage disable (UVLO) set to 4V (typical) to protect the external FETs from excessive power dissipation caused by not being fully enhanced. If the INTV_{CC} pin drops below the UVLO threshold, the GATE pin is forced to 0V, TG pin is pulled high and the soft-start pin will be reset. If the input voltage, V_{IN}, will not exceed 8V, then the INTV_{CC} pin should be connected to the input supply. Be aware that a small current (typically 13μA) loads the INTV_{CC} in shutdown. If V_{IN} is normally above, but occasionally drops below the INTV_{CC} regulation voltage, then the minimum operating V_{IN} is close to 4.5V. This value is determined by the dropout voltage of the linear regulator and the 4V INTV_{CC} undervoltage lockout threshold mentioned above.

Programming the Turn-On and Turn-Off Thresholds with the EN/UVLO Pin

The falling UVLO value can be accurately set by the resistor divider. A small 3μA pull-down current is active when EN/UVLO is below the threshold. The purpose of this current is to allow the user to program the rising hysteresis. The following equations should be used to determine the values of the resistors:

$$V_{IN(FALLING)} = 1.22 \cdot \frac{R1+R2}{R2}$$

$$V_{IN(RISING)} = V_{IN(FALLING)} + 3\mu A \cdot R1$$

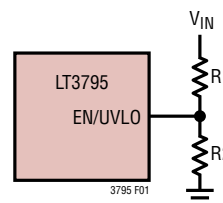

Figure 1.

Programming the Overvoltage Lockout Threshold with the OVLO Pin

The input overvoltage lockout protection feature can be implemented by a resistor from the V_{IN} to OVLO pins as shown in Figure 2. The following equations should be used to determine the values of the resistors:

$$V_{IN,OVLO} = 1.25 \cdot \frac{R3+R4}{R4}$$

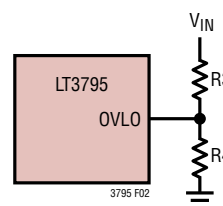

Figure 2.

LED Current Programming

The LED current is programmed by placing an appropriate value current sense resistor R_{LED} between the ISP and ISN pins. For best fault protection provided by the high side PMOS disconnect switch, sensing of the current should be done at the top of the LED string. If this option is not available, then the current may be sensed at the bottom of the string. Both the CTRL pins should be tied to a voltage higher than 1.2V to get the full-scale 250mV (typical) threshold across the sense resistor. Either CTRL pin can also be used to dim the LED current to zero, although relative accuracy decreases with the decreasing voltage sense threshold. The two CTRL pins have identical functions. Whichever is the lowest takes precedence. When the lower CTRL pin voltage is less than 1V, the LED current is:

$$I_{LED} = \frac{V_{CTRL} - 100mV}{R_{LED} \cdot 4}, \quad 0.1V < V_{CTRL} < 1V$$

$$I_{LED} = 0, \quad V_{CTRL} = 0V$$

APPLICATIONS INFORMATION

When the lower CTRL pin voltage is between 1V and 1.2V, the LED current varies with CTRL, but departs from the previous equation by an increasing amount as the CTRL voltage increases. Ultimately above 1.2V, the LED current no longer varies with CTRL. The typical $V_{(ISP-ISN)}$ threshold vs CTRL is listed in Table 1.

Table 1. $V_{(ISP-ISN)}$ Threshold vs CTRL

V_{CTRL} (V)	$V_{(ISP-ISN)}$ (mV)
1	225
1.05	236
1.1	244.5
1.15	248.5
1.2	250

When both the CTRL pins are higher than 1.2V, the LED current is regulated to:

$$I_{LED} = \frac{250mV}{R_{LED}}$$

The CTRL pins should not be left open (tie to V_{REF} if not used). Either CTRL pin can also be used in conjunction with a thermistor to provide overtemperature protection for the LED load, or with a resistor divider to V_{IN} to reduce output power and switching current when V_{IN} is low. The presence of a time varying differential voltage signal (ripple) across ISP and ISN at the switching frequency is expected. The amplitude of this signal is increased by high LED load current, low switching frequency and/or a smaller value output filter capacitor. For best accuracy, the amplitude of this ripple should be less than 25mV.

Programming Output Voltage (Constant-Voltage Regulation) and Output Voltage Open LED and Shorted LED Thresholds

The LT3795 has a voltage feedback pin FB that can be used to program a constant-voltage output. In addition, FB programming determines the output voltage that will cause $\overline{OPENLED}$ and $\overline{SHORTLED}$ to assert. For a boost LED driver, the output voltage can be programmed by selecting the values of R5 and R6 (see Figure 3) according to the following equation:

$$V_{OUT} = 1.25 \cdot \frac{R5 + R6}{R6}$$

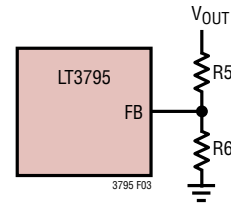

Figure 3. Feedback Resistor Connections for Boost and SEPIC Applications

For an LED driver of buck mode or a buck-boost mode configuration, the FB voltage is typically level shifted to a signal with respect to GND as illustrated in Figure 4. The output can be expressed as:

$$V_{OUT} = 1.25 \cdot \frac{R7}{R8} + V_{BE(Q1)}$$

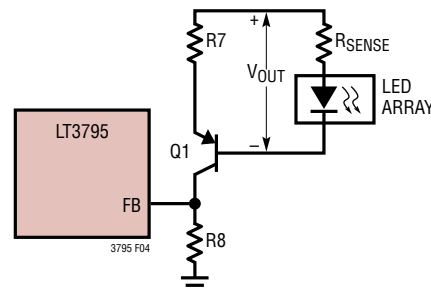

Figure 4. Feedback Resistor Connection for Buck Mode or Buck-Boost Mode LED Driver

If the open LED clamp voltage is programmed correctly using the resistor divider, then the FB pin should never exceed 1.2V when LEDs are connected.

To detect both open-circuit and short-circuit conditions at the output, the LT3795 monitors both output voltage and current. When FB exceeds $V_{FB} - 52mV$, $\overline{OPENLED}$ is asserted if $V_{(ISP-ISN)}$ is less than 25mV. $\overline{OPENLED}$ is de-asserted when $V_{(ISP-ISN)}$ is higher than 70mV (typical) or FB drops below $V_{FB} - 62mV$ (typical).

The $\overline{SHORTLED}$ pin is asserted if $V_{(ISP-ISN)} > 375mV$ or the FB pin falls below 300mV (typical) after initial start-up and SS reaches 1.7V. The ratio between the FB $\overline{OPENLED}$ threshold of 1.2V and the $\overline{SHORTLED}$ threshold of 0.3V can limit the range of V_{OUT} . The range of V_{OUT} using the maximum $\overline{SHORTLED}$ threshold of 0.35V is 3.5:1. The range of V_{OUT} can be made wider using the circuits shown

APPLICATIONS INFORMATION

in Figure 5 and Figure 6. For a V_{OUT} range that is greater than 8:1, consult factory applications.

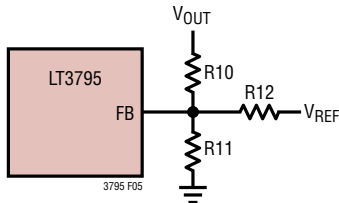

Figure 5. Feedback Resistor Connection for Wide Range Output in Boost and SEPIC Applications

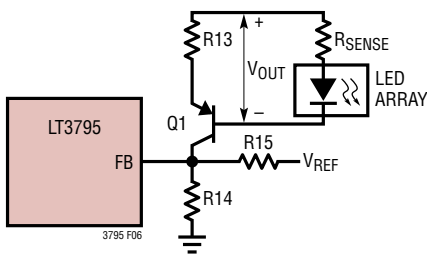

Figure 6. Feedback Resistor Connection for Wide Range Output in Buck Mode and Buck-Boost Mode Applications

The equations to widen the range of V_{OUT} are derived using a $\overline{\text{SHORTLED}}$ threshold of 0.35V, an $\overline{\text{OPENLED}}$ threshold of 1.2V and a reference voltage V_{REF} of 2V. The resistor values for R11 and R12 in Figure 5 can be calculated as shown below. See the example that follows for a suggested R10 value.

$$R11 = R10 \cdot \frac{1.7}{1.65 \cdot V_{OUT}^H - 0.8 \cdot V_{OUT}^L - 1.7}$$

$$R12 = R10 \cdot \frac{1.7}{0.35 \cdot V_{OUT}^H - 1.2 \cdot V_{OUT}^L}$$

Example: Calculate the resistor values required to increase the V_{OUT} range of a boost LED driver to 5:1 and have $\overline{\text{OPENLED}}$ occur when V_{OUT} is 91.4V:

Step 1: Choose $R10 = 1M$

Step 2: $V_{OUT}^L = 91.4/5 = 18.3$

Step 3:

$$R11 = 1000 \frac{1.7}{(1.65) 91.4 - (0.8) 18.3 - 1.7} = 12.64,$$

Use $R11 = 12.7k\Omega$

$$R12 = 1000 \frac{1.7}{(0.35) 91.4 - (1.2) 18.3} = 169k\Omega$$

The resistor values for R14 and R15 in Figure 6 can be calculated as shown below. See the example that follows for a suggested R13 value.

$$R14 = R13 \cdot \frac{1.7}{1.65 \cdot V_{OUT}^H - 0.8 \cdot V_{OUT}^L - 0.85 \cdot V_{BE}(Q1)}$$

$$R15 = R13 \cdot \frac{1.7}{0.35 \cdot V_{OUT}^H - 1.2 \cdot V_{OUT}^L + 0.85 \cdot V_{BE}(Q1)}$$

Example: Calculate the resistor values required to increase the V_{OUT} range of a buck-boost mode LED driver to 7.5:1 and have $\overline{\text{OPENLED}}$ occur when V_{OUT} is 43.5V. Use $V_{BE}(Q1) = 0.7V$:

Step 1: Choose $R13 = 357k$

Step 2: $V_{OUT}^L = 43.5/7.5 = 5.8$

Step 3:

$$R14 = 357 \frac{1.7}{(1.65) 43.5 - (0.8) 5.8 - (0.85) 0.7} = 9.12,$$

Use $R14 = 9.09k\Omega$

$$R15 = 357 \frac{1.7}{(0.35) 43.5 - (1.2) 5.8 + (0.85) 0.7} = 68.5,$$

Use $R15 = 68.1k\Omega$

LED Overcurrent Protection Feature

The ISP and ISN pins have a short-circuit protection feature independent of the LED current sense feature. This feature prevents the development of excessive switching currents and protects the power components. The short-circuit protection threshold (375mV, typ) is designed to be 50% higher than the default LED current sense threshold. Once the LED overcurrent is detected, the GATE pin is driven to GND to stop switching, TG pin is pulled high to disconnect the LED array from the power path, and fault protection is initiated via the SS pin.

APPLICATIONS INFORMATION

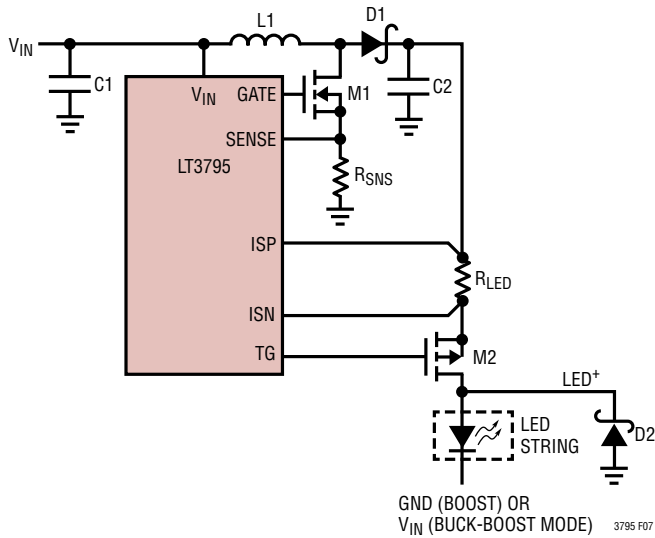

Figure 7. The Simplified LED Short-Circuit Protection Schematic for Boost or Buck-Boost Mode Converter

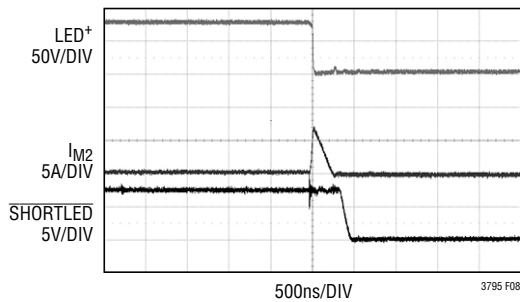

Figure 8. Short-Circuit Current

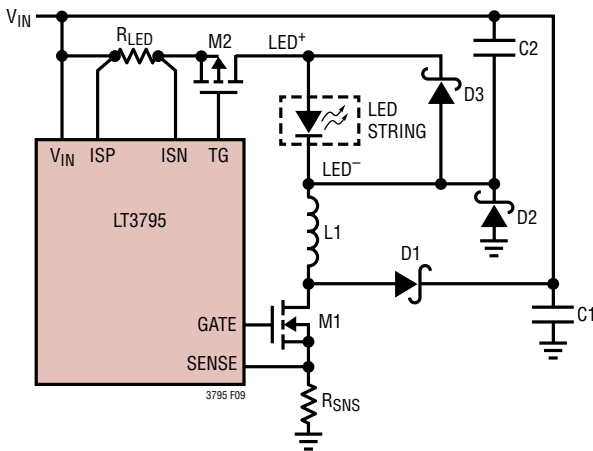

Figure 9. The Simplified LED Short-Circuit Protection Schematic for Buck Mode Converter

A typical LED short-circuit protection scheme for a boost or buck-boost mode converter is shown in Figure 7. The Schottky or ultrafast diode D2 should be put close to the drain of M2 on the board. It protects the LED+ node from swinging well below ground when being shorted to ground through a long cable. Usually, the internal protection loop takes about 100ns to respond as shown in Figure 8. Refer to the Short-Circuit Robust Boost LED Driver with Input Current Limit and Spread Spectrum Frequency Modulation application circuit for the test schematic. Note that the impedance of the short-circuit cable affects the peak current.

Schottky or UltraFast recovery diodes D2 and D3 are recommended to protect against a short circuit for the buck mode circuit shown in Figure 9.

PWM Dimming Control for Brightness

There are two methods to control the LED current for dimming using the LT3795. One method uses the CTRL pins to adjust the current regulated in the LEDs. A second method uses the PWM pin to modulate the LED current between zero and full current to achieve a precisely programmed average current, without the possibility of color shift that occurs at low current in LEDs. To make PWM dimming more accurate, the switch demand current is stored on the VC node during the quiescent phase when PWM is low. This feature minimizes recovery time when the PWM signal goes high. To further improve the recovery time, a disconnect switch should be used in the LED current path to prevent the output capacitor from discharging during the PWM signal low phase. The minimum PWM on or off time depends on the choice of operating frequency set by the RT input. For best current accuracy, the minimum PWM high time should be at least three switching cycles (3µs for fsw = 1MHz).

A low duty cycle PWM signal can cause excessive start-up times if it were allowed to interrupt the soft-start sequence. Therefore, once start-up is initiated by PWM > 1V, the LT3795 will ignore a logical disable by the external PWM input signal. The device will continue to soft-start with switching and TG enabled until either the voltage at SS reaches the 1.0V level, or the output current reaches one-fourth of the full-scale current. At this point the device will

APPLICATIONS INFORMATION

begin following the dimming control as designated by PWM. If at any time an output overcurrent is detected, GATE and TG will be disabled even as SS continues to charge.

Programming the Switching Frequency

The RT frequency adjust pin allows the user to program the switching frequency from 100kHz to 1MHz to optimize efficiency/performance or external component size. Higher frequency operation yields smaller component size but increases switching losses and gate driving current, and may not allow sufficiently high or low duty cycle operation. Lower frequency operation gives better performance at the cost of larger external component size. For an appropriate R_T resistor value see Table 2. An external resistor from the RT pin to GND is required—do not leave this pin open.

Table 2. Typical Switching Frequency vs R_T Value (1% Resistor)

f_{osc} (kHz)	R_T (k Ω)
1000	6.65
900	7.50
800	8.87
700	10.2
600	12.4
500	15.4
400	19.6
300	26.1
200	39.2
100	82.5

Spread Spectrum Frequency Modulation

Switching regulators can be particularly troublesome for applications where electromagnetic interference (EMI) is a concern. To improve the EMI performance, the LT3795 includes a spread spectrum frequency feature. If there is a capacitor (C_{RAMP}) at the RAMP pin, a triangle wave sweeping between 1V and 2V is generated. This signal is then fed into the internal oscillator to modulate the switching frequency between 70% of the base frequency and the base frequency, which is set by the R_T resistor. The modulation frequency is set by $12\mu A / (2 \cdot 1V \cdot C_{RAMP})$. Figure 10 shows the noise spectrum comparison between a conventional boost switching converter (with the LT3795 RAMP pin tied to GND) and a spread spectrum modulation enabled boost switching converter with 6.8nF at the RAMP

pin (refer to the Boost LED Driver with Input Current Limit and Spread Spectrum Frequency Modulation application circuit). The results of EMI measurements are sensitive to the RAMP frequency selected with the capacitor. 1kHz is a good starting point to optimize peak measurements, but some fine tuning of this selection may be necessary to get the best overall EMI results in a particular system. Consult factory applications for more detailed information about EMI reduction.

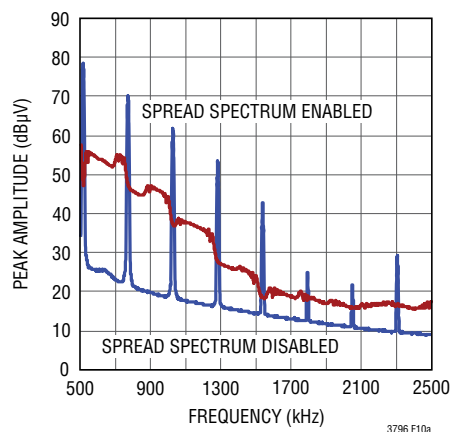

(10a) Conducted Average EMI Comparison

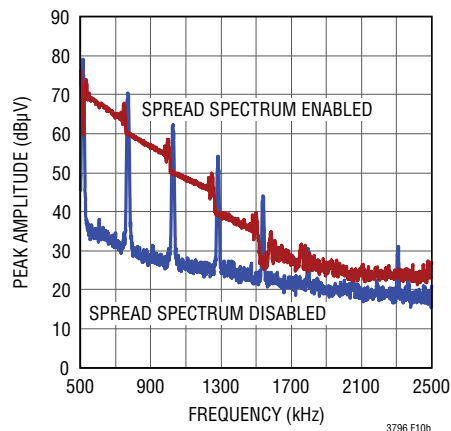

(10b) Conducted Peak EMI Comparison

Figure 10.

Duty Cycle Considerations

Switching duty cycle is a key variable defining converter operation, therefore, its limits must be considered when programming the switching frequency for a particular application. The fixed minimum on-time and minimum

APPLICATIONS INFORMATION

off-time (see Figure 11) and the switching frequency define the minimum and maximum duty cycle of the switch, respectively. The following equations express the minimum/ maximum duty cycle:

Minimum Duty Cycle = minimum on-time • switching frequency

Maximum Duty Cycle = 1 – minimum off-time • switching frequency

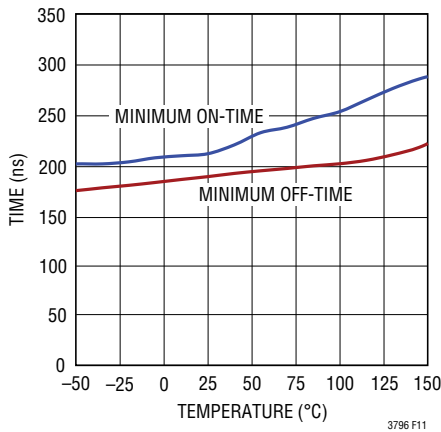

Figure 11. Typical Minimum On- and Off-Time vs Temperature

When calculating the operating limits, the typical values for on/off-time in the data sheet should be increased by at least 100ns to allow margin for PWM control latitude, GATE rise/fall times and SW node rise/fall times.

Setting Input Current Limit

The LT3795 has a standalone input current sense amplifier to limit the input current. The input current I_{IN} shown in Figure 12 is converted to a voltage output at the IVINCOMP pin. When the IVINCOMP voltage exceeds 1.2V the GATE is pulled low, and the converter stops switching. The input current limit is calculated as follows:

$$I_{IN} = \frac{60\text{mV}}{R_{INSNS}}$$

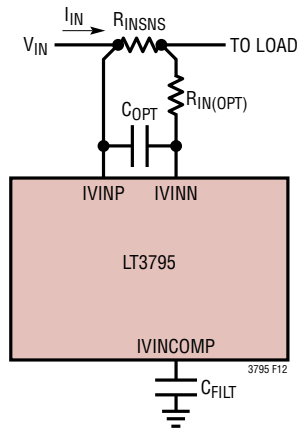

Figure 12. Setting Input Current Limit

Filter capacitor C_{FILT} shown in Figure 12 filters the voltage at the IVINCOMP pin to minimize ripple due to the input current. C_{FILT} also compensates the input current regulation loop, and is selected based on the loop response in addition to the intended voltage ripple on IVINCOMP. The IVINCOMP pin resistance to ground and C_{FILT} form a second pole in the input current regulation loop in addition to the dominant pole at V_C pin. Suggested values for C_{FILT} of 10nF - 0.1 μ F will usually provide a second pole in the input current regulation loop that results in stable loop response and is equivalent to the second pole in the ISP/ISN regulation loop, which consists of the output capacitance C_{OUT} and the dynamic resistance of the LED load. For buck mode applications, filter components, $R_{IN(OPT)}$ and C_{OPT} , can be placed close to LT3795 to suppress substantial transient signal or noise at the IVINN and IVINP pins. For boost and buck-boost mode applications, $R_{IN(OPT)}$ and C_{OPT} are not required.

Thermal Considerations

The LT3795 is rated to a maximum input voltage of 110V. Careful attention must be paid to the internal power dissipation of the IC at higher input voltages to ensure that a junction temperature of 150°C is not exceeded. This junction limit is especially important when operating at high ambient temperatures. The majority of the power dissipation in the IC comes from the supply current needed to

APPLICATIONS INFORMATION

drive the gate capacitance of the external power N-channel MOSFET. This gate drive current can be calculated as:

$$I_{GATE} = f_{SW} \cdot Q_G$$

A low Q_G power MOSFET should always be used when operating at high input voltages, and the switching frequency should also be chosen carefully to ensure that the IC does not exceed a safe junction temperature. The internal junction temperature, T_J of the IC can be estimated by:

$$T_J = T_A + [V_{IN} \cdot (I_Q + f_{SW} \cdot Q_G) \cdot \theta_{JA}]$$

where T_A is the ambient temperature, I_Q is the quiescent current of the part (2.9mA typical) and θ_{JA} is the package thermal impedance (30°C/W for the TSSOP package). For example, an application with $T_{A(MAX)} = 85^\circ\text{C}$, $V_{IN(MAX)} = 60\text{V}$, $f_{SW} = 400\text{kHz}$, and having a N-channel MOSFET with $Q_G = 20\text{nC}$, the maximum IC junction temperature will be approximately:

$$T_J = 85^\circ\text{C} + [60\text{V} \cdot (2.9\text{mA} + 400\text{kHz} \cdot 20\text{nC}) \cdot 30^\circ\text{C/W}] \\ \approx 104.6^\circ\text{C}$$

The exposed pad on the bottom of the package must be soldered to a ground plane. This ground should then be connected to an internal copper ground plane with thermal vias placed directly under the package to spread out the heat dissipated by the IC.

It is best if the copper plane is extended on either the top or bottom layer of the PCB to have the maximum exposure to air. Internal ground layers do not dissipate thermals as much as top and bottom layer copper does. See the recommended layout as an example.

Input Capacitor Selection

The input capacitor supplies the transient input current for the power inductor of the converter and must be placed and sized according to the transient current requirements. The switching frequency, output current and tolerable input voltage ripple are key inputs to estimating the capacitor value. An X7R type ceramic capacitor is usually the best choice since it has the least variation with temperature and DC bias. Typically, boost and SEPIC converters require a lower value capacitor than a buck mode converter.

Assuming that a 100mV input voltage ripple is acceptable, the required capacitor value for a boost converter can be estimated as follows ($T_{SW} = 1/f_{OSC}$):

$$C_{IN}(\mu\text{F}) = I_{LED}(\text{A}) \cdot \frac{V_{LED}}{V_{IN}} \cdot T_{SW}(\mu\text{s}) \cdot \frac{1\mu\text{F}}{\text{A} \cdot \mu\text{s} \cdot 2.8}$$

Therefore, a 2.2μF capacitor is an appropriate selection for a 400kHz boost regulator with 12V input, 48V output and 500mA load.

With the same V_{IN} voltage ripple of less than 100mV, the input capacitor for a buck mode converter can be estimated as follows:

$$C_{IN}(\mu\text{F}) = I_{LED}(\text{A}) \cdot \frac{V_{LED}(V_{IN} - V_{LED})}{V_{IN}^2} \cdot T_{SW}(\mu\text{s}) \cdot \frac{10\mu\text{F}}{\text{A} \cdot \mu\text{s}}$$

A 10μF input capacitor is an appropriate selection for a 400kHz buck mode converter with 24V input, 12V output and 1A load.

In the buck mode configuration, the input capacitor has large pulsed currents due to the current returned through the Schottky diode when the switch is off. It is important to place the capacitor as close as possible to the Schottky diode and to the GND return of the switch (i.e., the sense resistor). It is also important to consider the ripple current rating of the capacitor. For best reliability, this capacitor should have low ESR and ESL and have an adequate ripple current rating. The RMS input current for a buck mode LED driver is:

$$I_{IN(RMS)} = I_{LED} \cdot \sqrt{(1-D)D} \\ D = \frac{V_{LED}}{V_{IN}}$$

where D is the switch duty cycle.

Table 3. Recommended Ceramic Capacitor Manufacturers

MANUFACTURER	WEB
TDK	www.tdk.com
Kemet	www.kemet.com
Murata	www.murata.com
Taiyo Yuden	www.t-yuden.com
AVX	www.avx.com

APPLICATIONS INFORMATION

Output Capacitor Selection

The selection of the output capacitor depends on the load and converter configuration, i.e., step-up or step-down and the operating frequency. For LED applications, the equivalent resistance of the LED is typically low and the output filter capacitor should be sized to attenuate the current ripple. Use of an X7R type ceramic capacitor is recommended.

To achieve the same LED ripple current, the required filter capacitor is larger in the boost and buck-boost mode applications than that in the buck mode applications. Lower operating frequencies will require proportionately higher capacitor values. The component values shown in the data sheet applications are appropriate to drive the specified LED string. The product of the output capacitor and LED string impedance decides the second dominant pole in the LED current regulation loop. It is prudent to validate the power supply with the actual load (or loads).

Power MOSFET Selection

For applications operating at high input or output voltages, the power N-channel MOSFET switch is typically chosen for drain voltage V_{DS} rating and low gate charge Q_G . Consideration of switch on-resistance, $R_{DS(ON)}$, is usually secondary because switching losses dominate power loss. The INTV_{CC} regulator on the LT3795 has a fixed current limit to protect the IC from excessive power dissipation at high V_{IN} , so the MOSFET should be chosen so that the product of Q_G at 7.7V and switching frequency does not exceed the INTV_{CC} current limit. For driving LEDs, be careful to choose a switch with a V_{DS} rating that exceeds the threshold set by the FB pin in case of an open load fault. Several MOSFET vendors are listed in Table 4. The MOSFETs used in the application circuits in this data sheet have been found to work well with the LT3795. Consult factory applications for other recommended MOSFETs.

Table 4. MOSFET Manufacturers

VENDOR	WEB
Vishay Siliconix	www.vishay.com
Fairchild	www.fairchildsemi.com
International Rectifier	www.irf.com
Infineon	www.infineon.com

High Side PMOS Disconnect Switch Selection

A high side PMOS disconnect switch with a minimum V_{TH} of $-1V$ to $-2V$ is recommended in most LT3795 applications to optimize or maximize the PWM dimming ratio and protect the LED string from excessive heating during fault conditions as well. The PMOS disconnect switch is typically selected for drain-source voltage V_{DS} , and continuous drain current I_D . For proper operations, V_{DS} rating must exceed the open LED regulation voltage set by the FB pin, and I_D rating should be above I_{LED} .

Schottky Rectifier Selection

The power Schottky diode conducts current during the interval when the switch is turned off. Select a diode rated for the maximum SW voltage. It is important to choose a Schottky diode with sufficiently low leakage current when using the PWM feature for dimming, because leakage increases with temperature and occurs from the output during the PWM low interval. Table 5 has some recommended component vendors.

Table 5. Schottky Rectifier Manufacturers

VENDOR	WEB
On Semiconductor	www.onsemi.com
Diodes, Inc	www.diodes.com
Central Semiconductor	www.centalsemi.com
Rohm Semiconductor	www.rohm.com

Sense Resistor Selection

The resistor, R_{SENSE} , between the source of the external N-channel MOSFET and GND should be selected to provide adequate switch current to drive the application without exceeding the 113mV (typical) current limit threshold on the SENSE pin of the LT3795. For buck mode applications, select a resistor that gives a switch current at least 30% greater than the required LED current. For buck mode, select a resistor according to:

$$R_{SENSE(BUCK)} \leq \frac{0.07V}{I_{LED}}$$

APPLICATIONS INFORMATION

For buck-boost mode, select a resistor according to:

$$R_{\text{SENSE(BUCK-BOOST)}} \leq \frac{V_{\text{IN}} \cdot 0.07\text{V}}{(V_{\text{IN}} + V_{\text{LED}}) I_{\text{LED}}}$$

For boost, select a resistor according to:

$$R_{\text{SENSE(BOOST)}} \leq \frac{V_{\text{IN}} \cdot 0.07\text{V}}{V_{\text{LED}} \cdot I_{\text{LED}}}$$

The placement of R_{SENSE} should be close to the source of the N-channel MOSFET and GND of the LT3795. The SENSE input to LT3795 should be a Kelvin connection to the positive terminal of R_{SENSE} .

70mV is used in the equations above to give some margin below the 113mV (typical) sense current limit threshold.

Inductor Selection

The inductor used with the LT3795 should have a saturation current rating appropriate to the maximum switch current selected with the R_{SENSE} resistor. Choose an inductor value based on operating frequency and input and output voltage to provide a current mode signal on SENSE of approximately 20mV magnitude. The following equations are useful to estimate the inductor value ($T_{\text{SW}} = 1/f_{\text{OSC}}$):

$$L_{\text{BUCK}} = \frac{T_{\text{SW}} \cdot R_{\text{SENSE}} \cdot V_{\text{LED}} (V_{\text{IN}} - V_{\text{LED}})}{V_{\text{IN}} \cdot 0.02\text{V}}$$

$$L_{\text{BUCK-BOOST}} = \frac{T_{\text{SW}} \cdot R_{\text{SENSE}} \cdot V_{\text{LED}} \cdot V_{\text{IN}}}{(V_{\text{LED}} + V_{\text{IN}}) \cdot 0.02\text{V}}$$

$$L_{\text{BOOST}} = \frac{T_{\text{SW}} \cdot R_{\text{SENSE}} \cdot V_{\text{IN}} (V_{\text{LED}} - V_{\text{IN}})}{V_{\text{LED}} \cdot 0.02\text{V}}$$

Table 6 provides some recommended inductor vendors.

Table 6. Inductor Manufacturers

VENDOR	WEB
Sumida	www.sumida.com
Würth Elektronik	www.we-online.com
Coiltronics	www.cooperet.com
Vishay	www.vishay.com
Coilcraft	www.coilcraft.com

Loop Compensation

The LT3795 uses an internal transconductance error amplifier whose V_C output compensates the control loop. The external inductor, output capacitor and the compensation resistor and capacitor determine the loop stability. The inductor and output capacitor are chosen based on performance, size and cost. The compensation resistor and capacitor at V_C are selected to optimize control loop response and stability. For typical LED applications, a 10nF compensation capacitor at V_C is adequate, and a series resistor should always be used to increase the slew rate on the V_C pin to maintain tighter regulation of LED current during fast transients on the input supply to the converter.

Soft-Start Capacitor Selection

For many applications, it is important to minimize the inrush current at start-up. The built-in soft-start circuit significantly reduces the start-up current spike and output voltage overshoot. The soft-start interval is set by the soft-start capacitor selection according to the equation:

$$T_{\text{SS}} = C_{\text{SS}} \cdot \frac{2\text{V}}{28\mu\text{A}}$$

A typical value for the soft-start capacitor is 0.1μF. The soft-start pin reduces the oscillator frequency and the maximum current in the switch. Soft-start also operates as fault protection, which forces the converter into hiccup or latchoff mode. Detailed information is provided in the Fault Protection: Hiccup Mode and Latchoff Mode section.

APPLICATIONS INFORMATION

Fault Protection: Hiccup Mode and Latchoff Mode

If an LED overcurrent condition, $INTV_{CC}$ undervoltage, output short ($FB \leq 0.3V$), or thermal limit happens, the TG pin is pulled high to disconnect the LED array from the power path, and the GATE pin is driven low. If the soft-start pin is charging and still below 1.7V, then it will continue to do so with a $28\mu A$ source. Once above 1.7V, the pull-up source is disabled and a $2.8\mu A$ pull-down is activated. While the SS pin is discharging, the GATE is forced low. When the SS pin is discharged below 0.2V, a new cycle is initiated. This is referred as hiccup mode operation. If the fault still exists when SS crosses below 0.2V, then a full SS charge/discharge cycle has to complete before switching is enabled.

If a resistor is placed between the V_{REF} pin and SS pin to hold SS pin higher than 0.2V during a fault, then the LT3795 will enter latchoff mode with GATE pin low, and TG pin high. To exit latchoff mode, the EN/UVLO pin must be toggled low to high.

Board Layout

The high speed operation of the LT3795 demands careful attention to board layout and component placement. The exposed pad of the package is the GND terminal of the IC and is also important for thermal management of the IC. It is crucial to achieve a good electrical and thermal contact between the exposed pad and the ground plane of the board. To reduce electromagnetic interference (EMI), it is

important to minimize the area of the high dV/dt switching node between the inductor, switch drain and anode of the Schottky rectifier. Use a ground plane under the switching node to eliminate interplane coupling to sensitive signals. The lengths of the high dI/dt traces: 1) from the switch node through the switch and sense resistor to GND, and 2) from the switch node through the Schottky rectifier and filter capacitor to GND should be minimized. The ground points of these two switching current traces should come to a common point then connect to the ground plane under the LT3795. Likewise, the ground terminal of the bypass capacitor for the $INTV_{CC}$ regulator should be placed near the GND of the switching path. Typically, this requirement results in the external switch being closest to the IC, along with the $INTV_{CC}$ bypass capacitor. The ground for the compensation network and other DC control signals should be star connected to the underside of the IC. Do not extensively route high impedance signals such as FB, RT and V_C , as they may pick up switching noise. Since there is a small variable DC input bias current to the ISN and ISP inputs, resistance in series with these pins should be minimized to avoid creating an offset in the current sense threshold. Likewise, minimize resistance in series with the SENSE input to avoid changes (most likely reduction) to the switch current limit threshold.

Figure 13 is a suggested two sided layout for a boost converter. Note that the 4-layer layout is recommended for best performance. Please contact the factory for the reference layout design.

APPLICATIONS INFORMATION

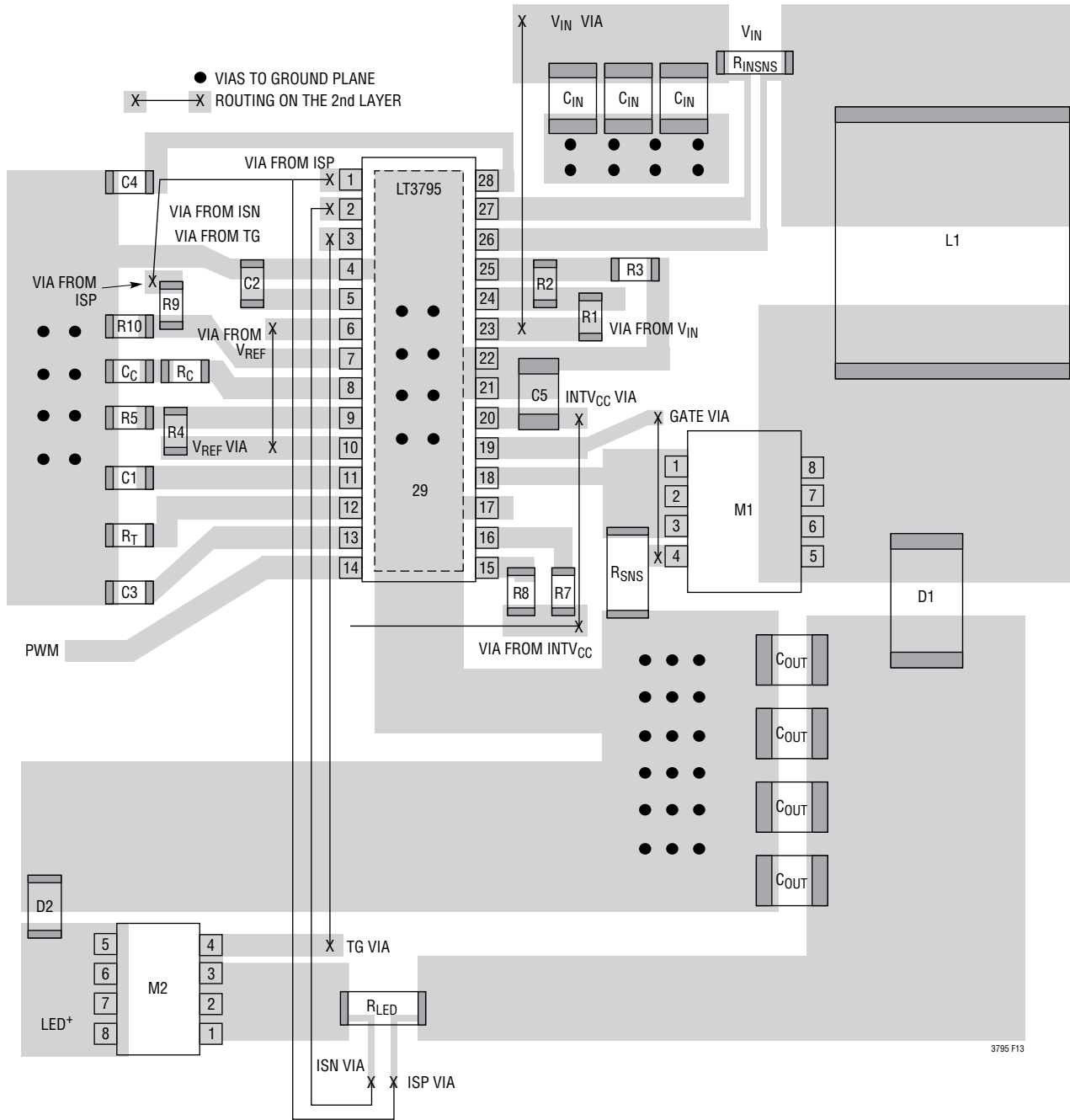

COMPONENT DESIGNATIONS REFER TO PAGE 23 CIRCUIT

Figure 13. Boost Converter Suggested Layout

TYPICAL APPLICATIONS

Short-Circuit Robust Boost LED Driver with Input Current Limit and Spread Spectrum Frequency Modulation

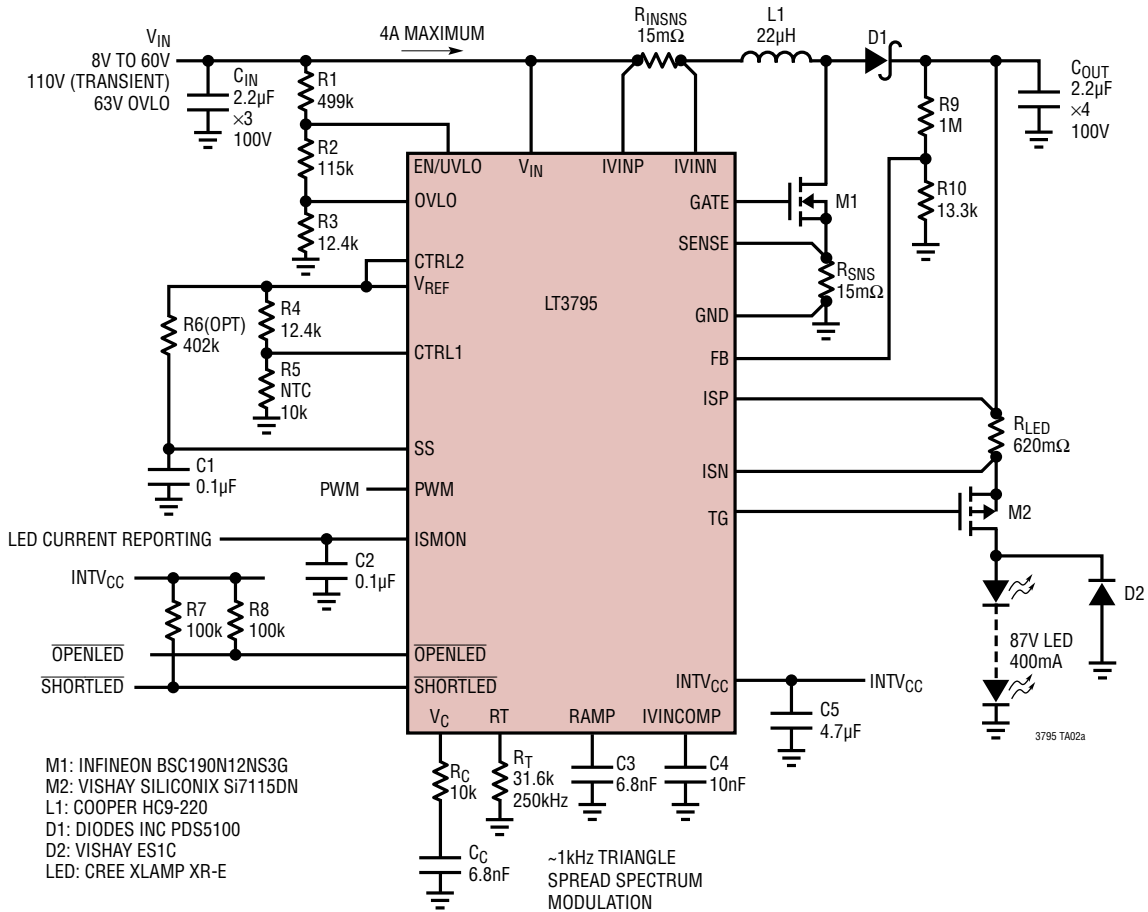

Short LED Protection without R6: Hiccup Mode

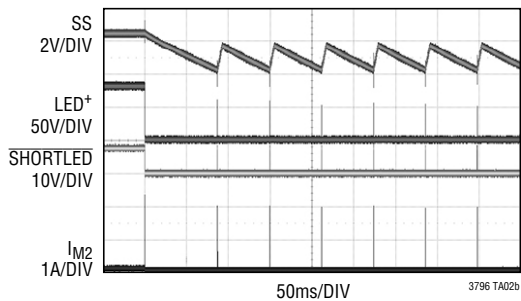

Short LED Protection with R6: Latchoff Mode

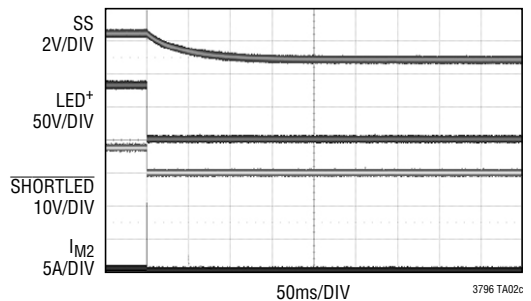

TYPICAL APPLICATIONS

SEPIC LED Driver with Input Current Limit

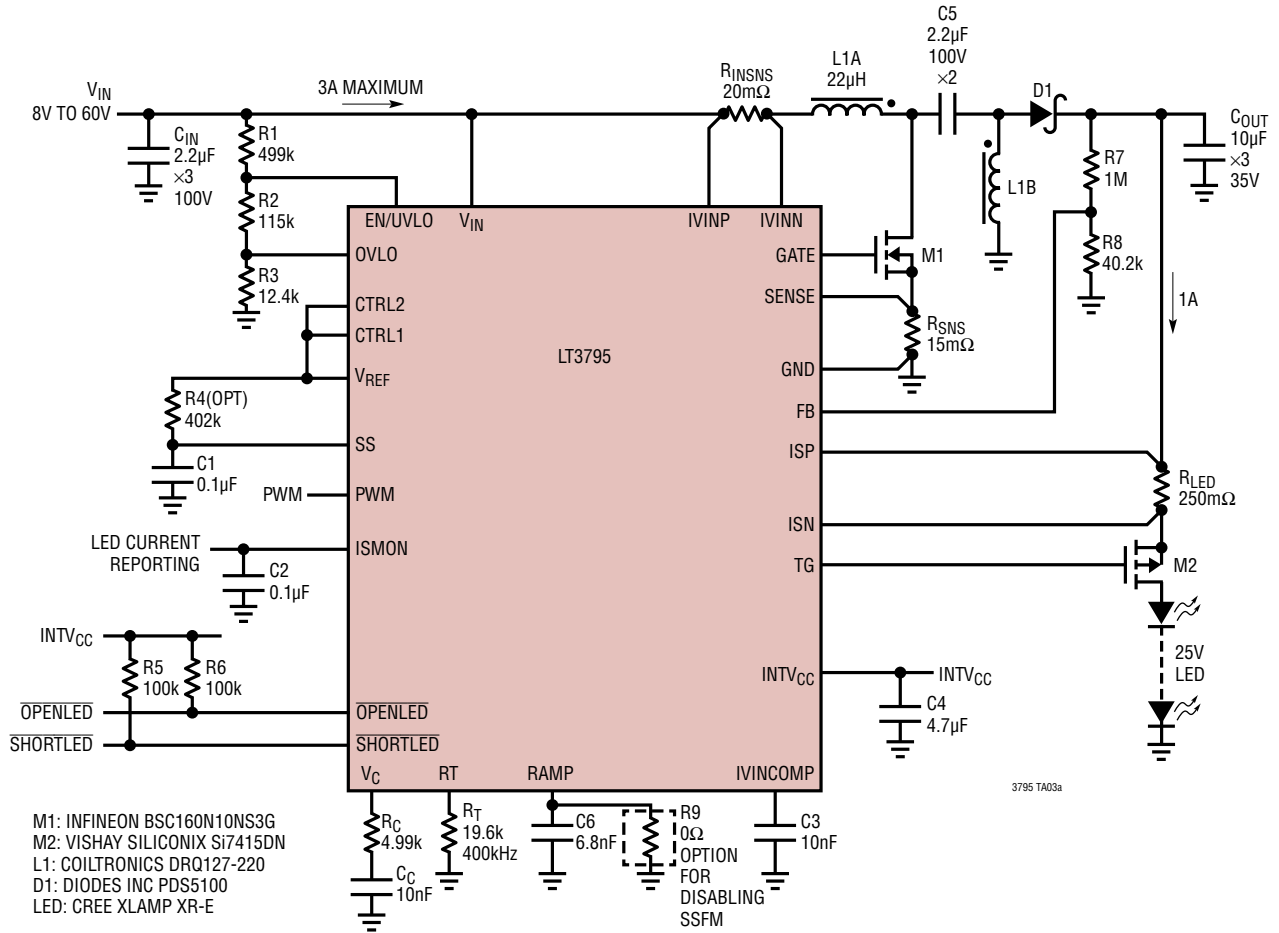

Efficiency

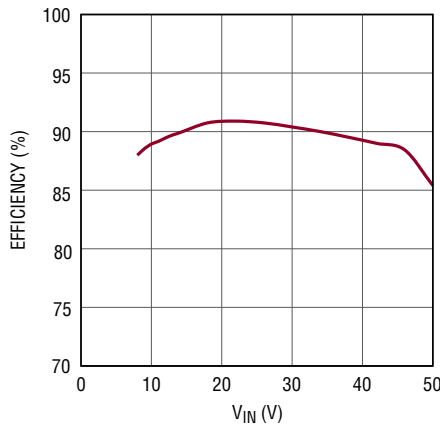

TYPICAL APPLICATIONS

Buck Mode LED Driver

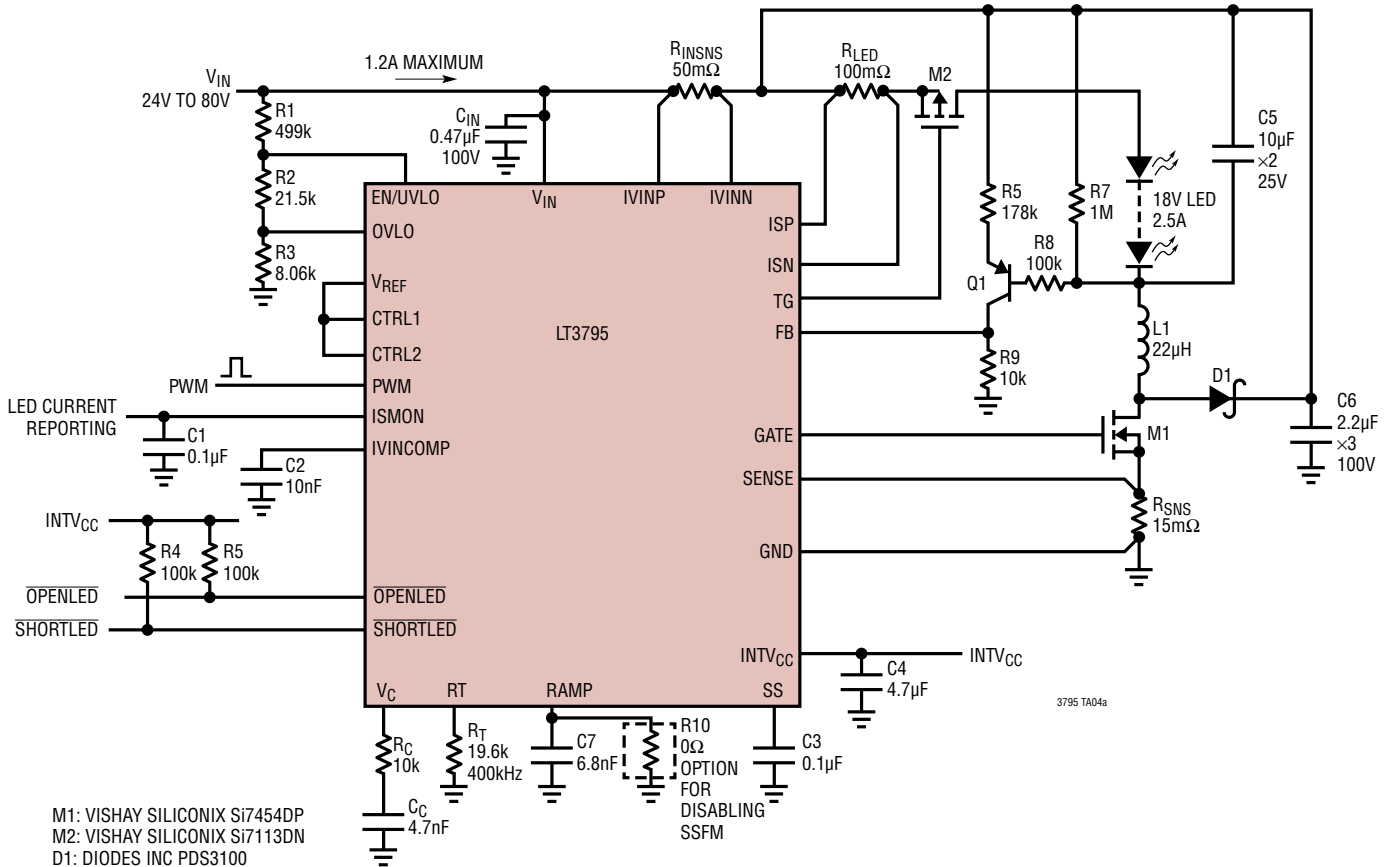

Efficiency

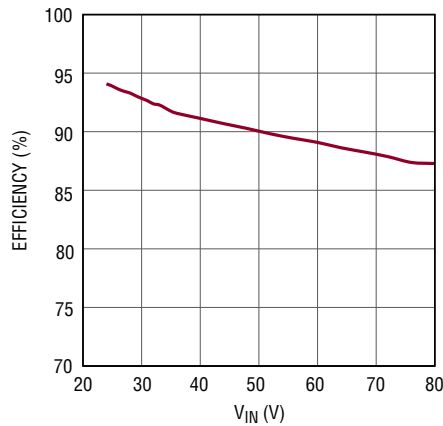

3796 TA04b

TYPICAL APPLICATIONS

Buck Mode LED Driver with 3000:1 PWM Dimming

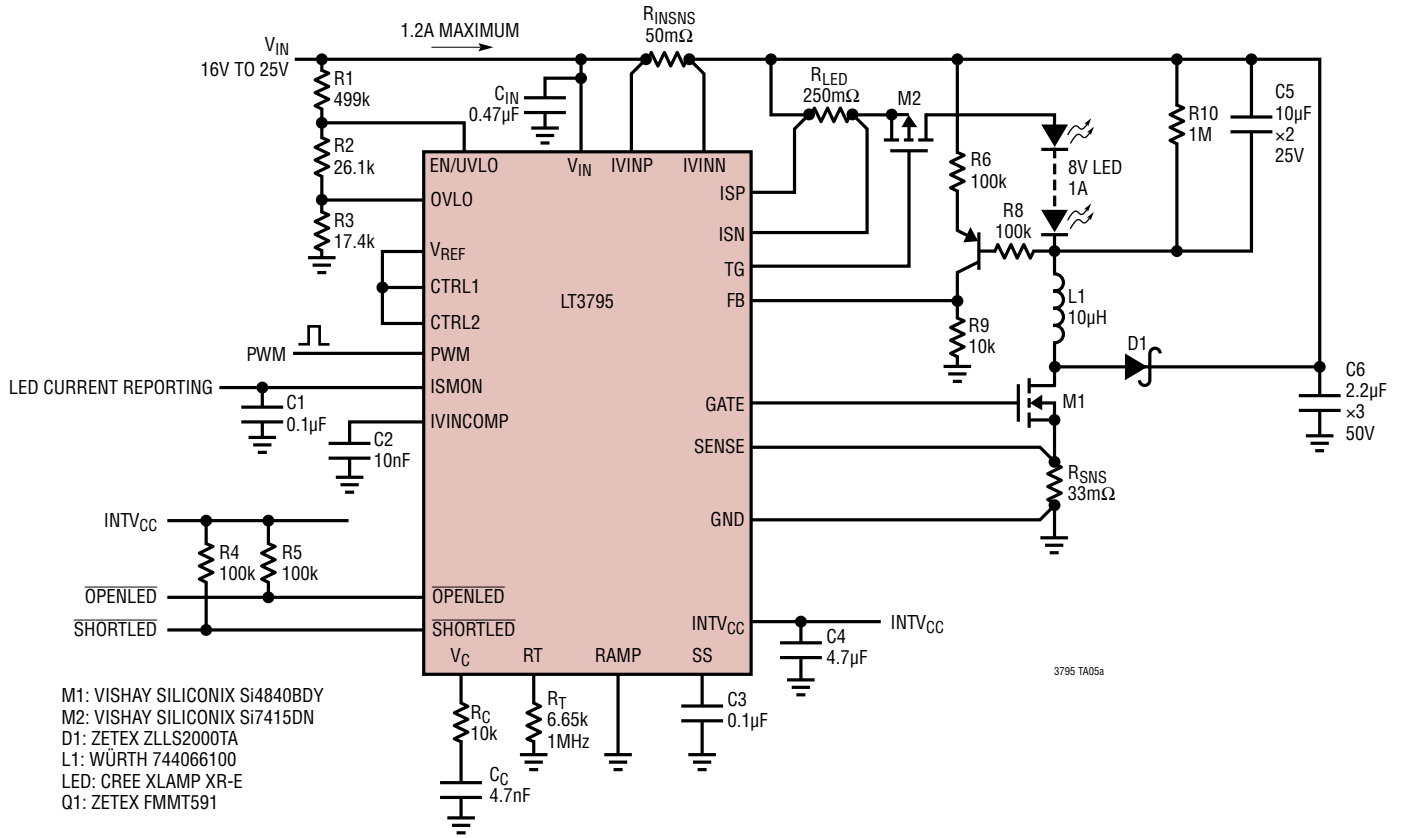

3000:1 PWM Dimming at 100Hz and $V_{IN} = 24V$

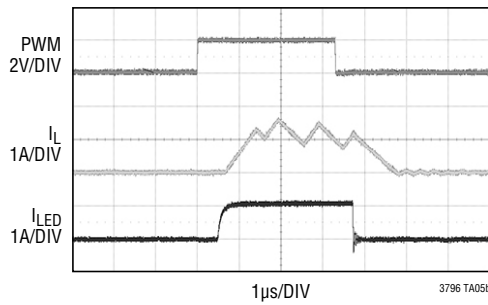

PACKAGE DESCRIPTION

**FE Package
28-Lead Plastic TSSOP (4.4mm)
(Reference LTC DWG # 05-08-1663 Rev L)
Exposed Pad Variation EB**

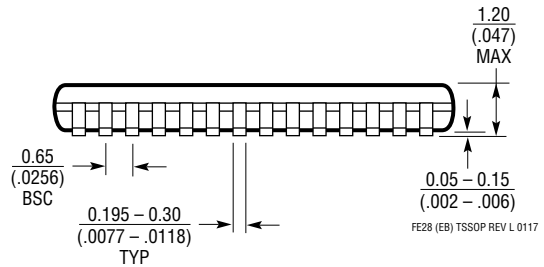
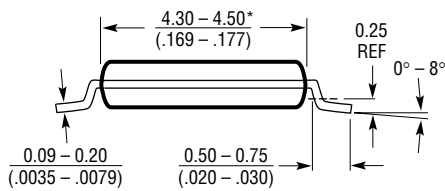
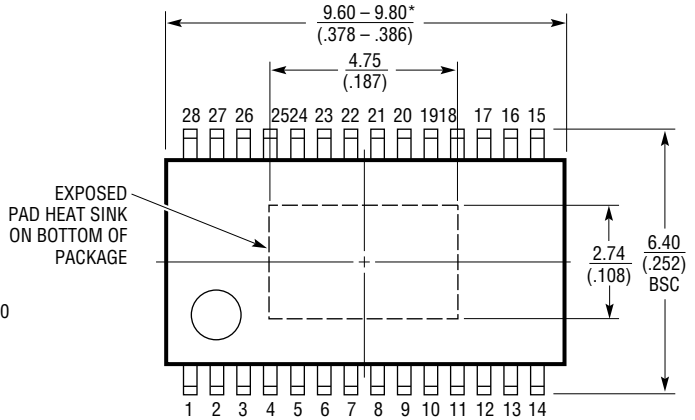
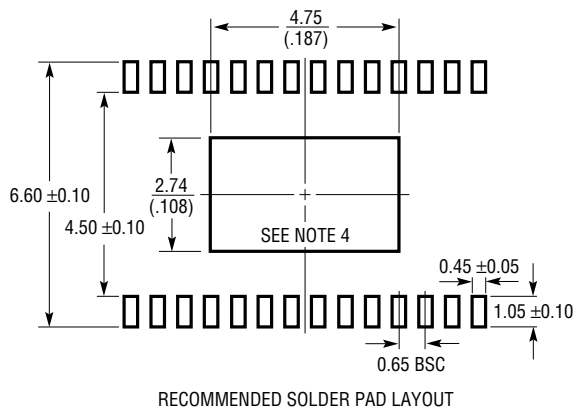

- NOTE:
1. CONTROLLING DIMENSION: MILLIMETERS
 2. DIMENSIONS ARE IN MILLIMETERS (INCHES)
 3. DRAWING NOT TO SCALE
 4. RECOMMENDED MINIMUM PCB METAL SIZE FOR EXPOSED PAD ATTACHMENT
- *DIMENSIONS DO NOT INCLUDE MOLD FLASH. MOLD FLASH SHALL NOT EXCEED 0.150mm (.006") PER SIDE

REVISION HISTORY

REV	DATE	DESCRIPTION	PAGE NUMBER
A	03/14	Clarified Spread Spectrum Description and Figure 10. Clarified Schematic, Graphs.	17 24, 25, 26, 30
B	05/14	Clarified Typical Application schematic. Clarified the Electrical Characteristics section. Clarified the Typical Application schematic.	1 2, 3, 4 30
C	06/16	Clarified Typical Application schematic. Clarified Electrical Characteristics. Clarified Typical Application schematic.	1 2, 3, 4 30
D	10/21	Added AEC-Q100 Qualification as a Feature. Added Automotive Products to Order Information.	1 2

TYPICAL APPLICATION

Buck-Boost Mode LED Driver

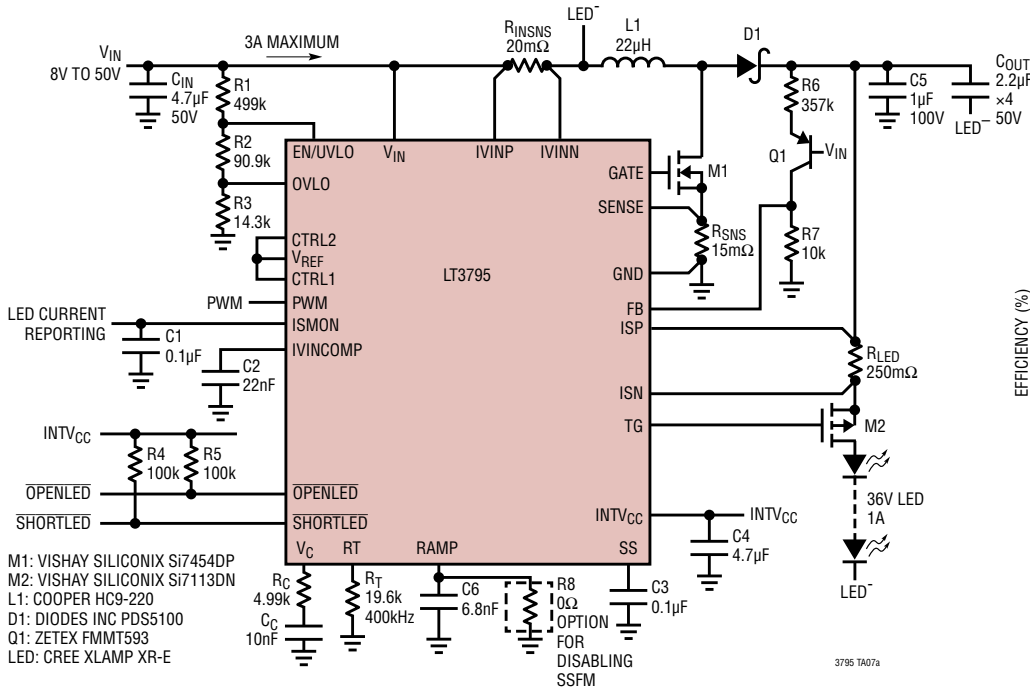

Efficiency vs V_{IN}

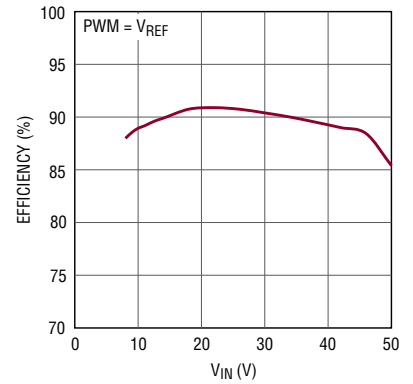

RELATED PARTS

PART NUMBER	DESCRIPTION	COMMENTS
LT3791	60V, Synchronous Buck-Boost 1MHz LED Controller	V_{IN} : 4.7V to 60V, V_{OUT} Range: 0V to 60V, True Color PWM, Analog = 100:1, $I_{SD} < 1\mu A$, TSSOP-38E Package
LT3796/LT3796-1	100V Constant Current and Constant Voltage Controller with Dual Current Sense	V_{IN} : 6V to 100V, $V_{OUT(MAX)} = 100V$, True Color PWM Dimming = 3000:1, $I_{SD} < 1\mu A$, 28-Lead TSSOP Package
LT3755/LT3755-1/LT3755-2	High Side 60V, 1MHz LED Controller with True Color 3,000:1 PWM Dimming	V_{IN} : 4.5V to 40V, V_{OUT} Range: 5V to 60V, True Color PWM, Analog = 3000:1, $I_{SD} < 1\mu A$, 3mm \times 3mm QFN-16, MSOP-16E Packages
LT3756/LT3756-1/LT3756-2	High Side 100V, 1MHz LED Controller with True Color 3,000:1 PWM Dimming	V_{IN} : 6V to 100V, V_{OUT} Range: 5V to 100V, True Color PWM, Analog = 3000:1, $I_{SD} < 1\mu A$, 3mm \times 3mm QFN-16, MSOP-16E Packages
LT3743	Synchronous Step-Down 20A LED Driver with Three-State LED Current Control	V_{IN} : 5.5V to 36V, V_{OUT} Range: 5.5V to 35V, True Color PWM, Analog = 3000:1, $I_{SD} < 1\mu A$, 4mm \times 5mm QFN-28, TSSOP-28E Packages
LT3517	1.3A, 2.5MHz High Current LED Driver with 3,000:1 Dimming	V_{IN} : 3V to 30V, True Color PWM, Analog = 3000:1, $I_{SD} < 1\mu A$, 4mm \times 4mm QFN-16 Package
LT3518	2.3A, 2.5MHz High Current LED Driver with 3,000:1 Dimming	V_{IN} : 3V to 30V, True Color PWM, Analog = 3000:1, $I_{SD} < 1\mu A$, 4mm \times 4mm QFN-16 Package
LT3474/LT3474-1	36V, 1A (I_{LED}), 2MHz, Step-Down LED Driver	V_{IN} : 4V to 36V, V_{OUT} Range = 13.5V, True Color PWM = 400:1, $I_{SD} < 1\mu A$, TSSOP-16E Package
LT3475/LT3475-1	Dual 1.5A (I_{LED}), 36V, 2MHz, Step-Down LED Driver	V_{IN} : 4V to 36V, V_{OUT} Range = 13.5V, True Color PWM, Analog = 3000:1, $I_{SD} < 1\mu A$, TSSOP-20E Package