

## Description

The AP3036B is an inductor-based DC/DC converter designed to drive up to eight white LEDs in series for backlight. Only one feedback resistor is needed to control the LED current and obtain required brightness.

A constant frequency 1.0MHz PWM control scheme is employed in this IC, which means tiny external components can be used. Specifically, 1mm tall inductor and 0.22 $\mu$ F output capacitor for a typical application is sufficient. Additionally, the Schottky diode in boost circuit is integrated on this chip. The AP3036B also provides a disable pin to ease its use for different systems.

The output over-voltage protection is implemented in AP3036B. When any LED is broken or in other abnormal conditions, the output voltage will be clamped.

The AP3036B is available in standard SOT26 package.

## Applications

- Cellular Phones
- Digital Cameras
- LCD Modules
- GPS Receivers
- PDAs, Handheld Computers

## Pin Assignments

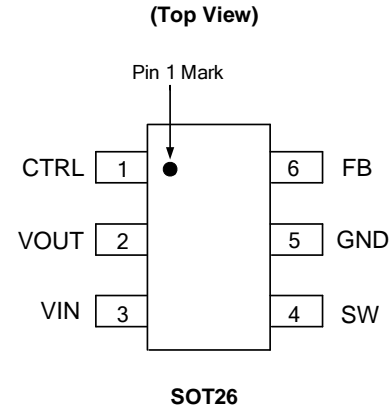

## Features

- Inherently Uniform LED Current
- High Efficiency up to 84%
- No Need for External Schottky Diode
- Output Over-voltage Protection (OVP)
- Fixed 1.0MHz Switching Frequency
- Uses Tiny 1mm Tall Inductor
- Requires Only 0.22 $\mu$ F Output Capacitor
- High Frequency Dimming Control
- **Totally Lead-Free & Fully RoHS Compliant (Notes 1 & 2)**
- **Halogen and Antimony Free. "Green" Device (Note 3)**

- Notes:
1. No purposely added lead. Fully EU Directive 2002/95/EC (RoHS) & 2011/65/EU (RoHS 2) compliant.
  2. See [http://www.diodes.com/quality/lead\\_free.html](http://www.diodes.com/quality/lead_free.html) for more information about Diodes Incorporated's definitions of Halogen- and Antimony-free, "Green" and Lead-free.
  3. Halogen- and Antimony-free "Green" products are defined as those which contain <900ppm bromine, <900ppm chlorine (<1500ppm total Br + Cl) and <1000ppm antimony compounds.

## Typical Applications Circuit (Note 4)

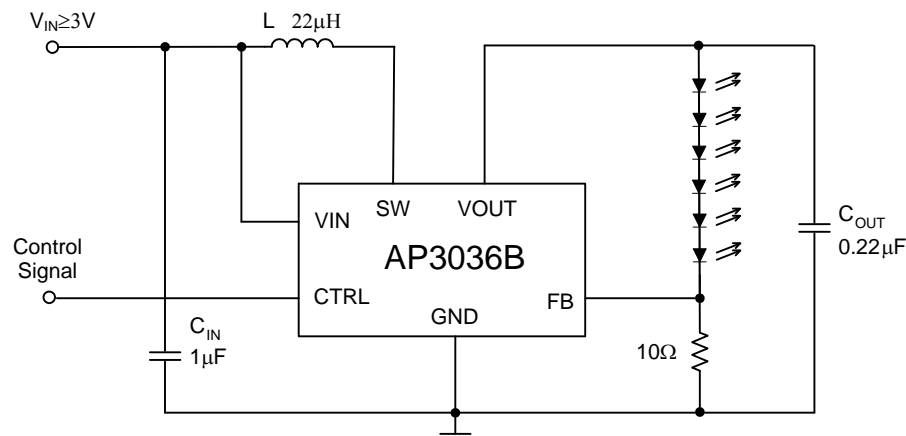

Note 4: C: X5R or X7R type dielectric, L: SUMIDA CDRH5D28R-220NC or equivalent. And, this circuit can work in full temperature.

**Pin Descriptions**

Pin Number	Pin Name	Function
1	CTRL	Shutdown and dimming pin. Connect to 1.5V or higher to enable device; Connect to 0.4V or less to disable device; Connect to a PWM signal to achieve LEDs brightness dimming
2	VOUT	Output pin. Connect to the cathode of internal Schottky diode
3	VIN	Input supply pin. Must be connected to a local bypass capacitor
4	SW	Switch pin. Connect external inductor
5	GND	Ground
6	FB	Voltage feedback pin. The reference voltage is 200mV

NEW PRODUCT

**Functional Block Diagram**

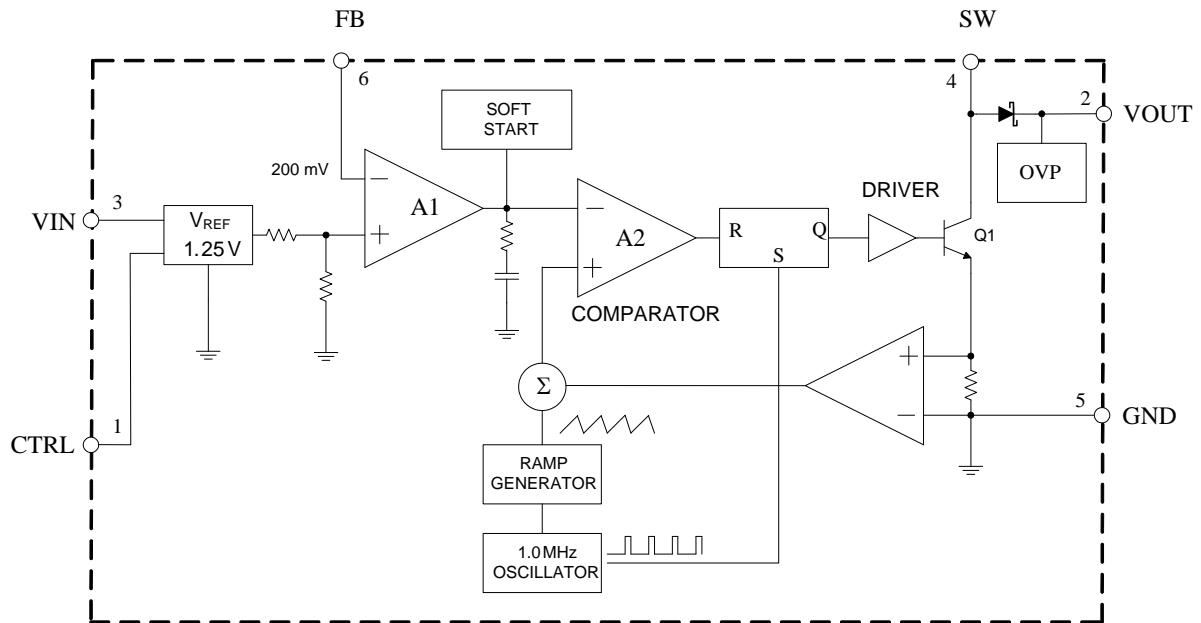

## Absolute Maximum Ratings (Note 5)

Symbol	Parameter	Rating	Unit
$V_{IN}$	Input Voltage	20	V
$V_{SW}$	SW Pin Voltage	38	V
$V_{FB}$	Feedback Voltage	20	V
$V_{CTRL}$	CTRL Pin Voltage	20	V
$\theta_{JA}$	Thermal Resistance (Junction to Ambient, No Heat Sink)	265	°C/W
$T_J$	Operating Junction Temperature	+150	°C
$T_{STG}$	Storage Temperature Range	-65 to +150	°C
$T_{LEAD}$	Lead Temperature (Soldering, 10sec)	+260	°C
–	ESD (Machine Model)	250	V
–	ESD (Human Body Model)	2000	V

Note 5: Stresses greater than those listed under "Absolute Maximum Ratings" may cause permanent damage to the device. These are stress ratings only, and functional operation of the device at these or any other conditions beyond those indicated under "Recommended Operating Conditions" is not implied. Exposure to "Absolute Maximum Ratings" for extended periods may affect device reliability.

## Recommended Operating Conditions

Symbol	Parameter	Min	Max	Unit
$T_{OP}$	Operating Temperature Range	-40	+85	°C
$V_{IN}$	Input Voltage	2.5	16	V
$V_{CTRL}$	CTRL Pin Voltage	–	16	V

**Electrical Characteristics** (@ $V_{IN} = 3V$ ,  $V_{CTRL} = 3V$ ,  $T_A = +25^\circ C$ , unless otherwise specified.)

Symbol	Parameter	Conditions	Min	Typ	Max	Unit
$V_{IN} (Min)$	Minimum Operating Voltage	–	2.5	–	–	V
$V_{IN} (Max)$	Maximum Operating Voltage	–	–	–	16	
$V_{FB}$	Feedback Voltage	$I_{OUT} = 20mA$ , 4 LEDs	188	200	212	mV
$I_{FB}$	FB Pin Bias Current	–	–	35	100	nA
$I_Q$	Quiescent Current	$V_{FB} = V_{IN}$ , No Switching	1.6	3.1	3.9	mA
$I_{SHDN}$	Shutdown Quiescent Current	$V_{CTRL} = 0V$	–	45	75	$\mu A$
f	Switching Frequency	–	–	1.0	–	MHz
$D_{MAX}$	Maximum Duty Cycle	–	90	93	–	%
$I_{LIMIT}$	Switch Current Limit (Note 6)	$D = 40\%$ or $80\%$	–	550	–	mA
$V_{CESAT}$	Switch $V_{CE}$ Saturation Voltage	$I_{SW} = 250mA$	–	360	–	mV
–	Switch Leakage Current	$V_{SW} = 5V$	–	0.01	5	$\mu A$
$V_{CTRL}$	CTRL Pin Voltage	High	1.5	–	–	V
		Low	–	–	0.4	
$I_{CTRL}$	CTRL Pin Bias Current	–	–	100	–	$\mu A$
$V_{OV}$	OVP Voltage	–	–	30	–	V
$V_{DROP}$	Schottky Forward Drop	$I_D = 150mA$	–	0.7	–	V
–	Schottky Leakage Current	$V_R$ (Reverse Voltage) = 23V	–	0.1	4	$\mu A$
		$V_R$ (Reverse Voltage) = 27V	–	–	150	
t	Soft Start Time	–	–	100	–	$\mu s$
$\theta_{JC}$	Thermal Resistance (Junction to Case)	SOT26	–	60	–	$^\circ C/W$

Note 6: The switch current limit is related to duty cycle. Please refer to Figure LED Current vs. Duty (PWM Frequency = 0.5kHz).

**Performance Characteristics** (The WLED forward voltage ( $V_F$ ) is 3.45V at  $I_F = 20\text{mA}$ , unless otherwise noted.)

**Efficiency vs. LED's Number**

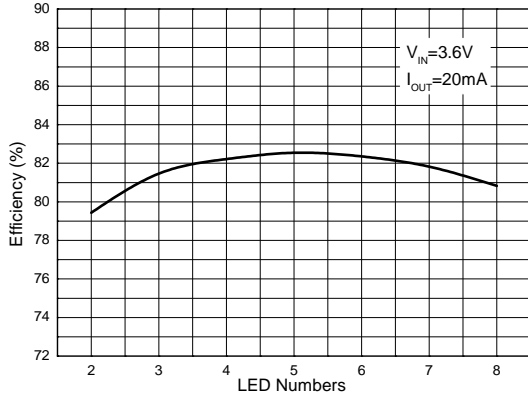

**Schottky Forward Voltage vs. Schottky Forward Current**

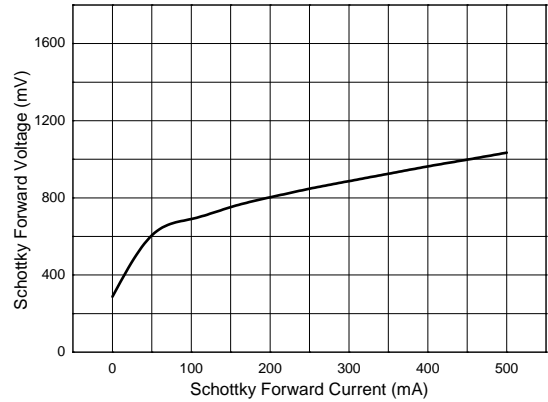

**Shutdown Current vs. Input Voltage**

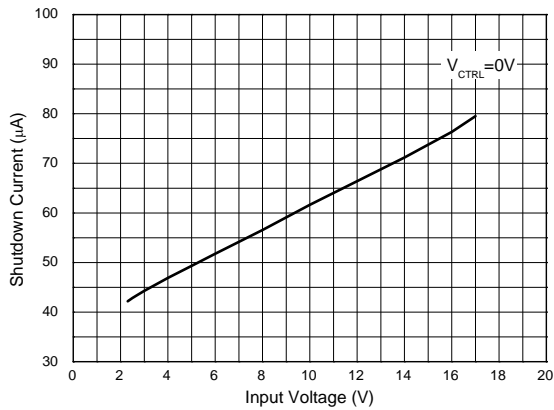

**Quiescent Current vs. Input Voltage**

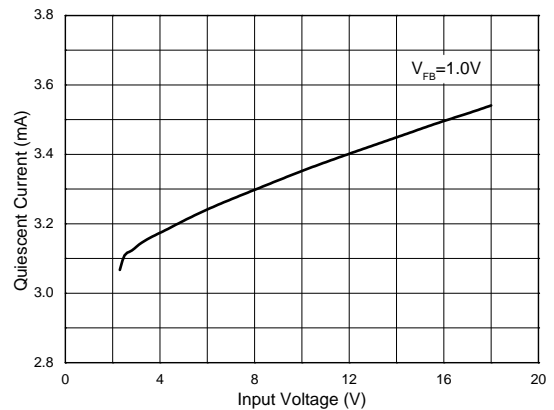

**Feedback Voltage vs. Temperature**

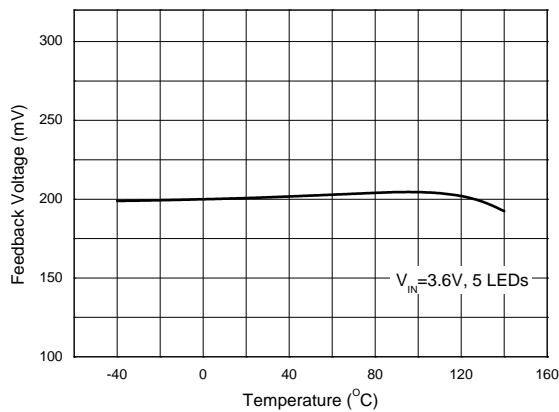

**Current Limit vs. Temperature**

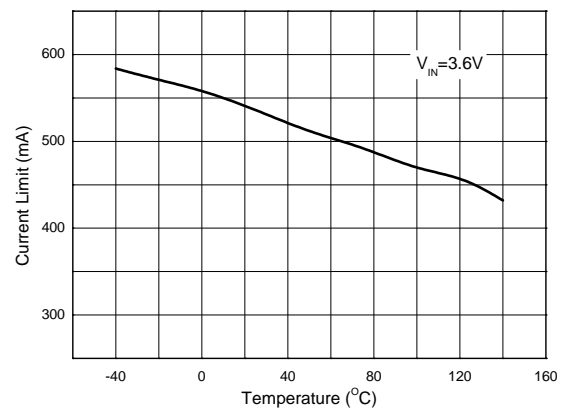

NEW PRODUCT

**Performance Characteristics** (Cont. The WLED forward voltage ( $V_F$ ) is 3.45V at  $I_F = 20\text{mA}$ , unless otherwise noted.)

**Saturation Voltage vs. Switch Current**

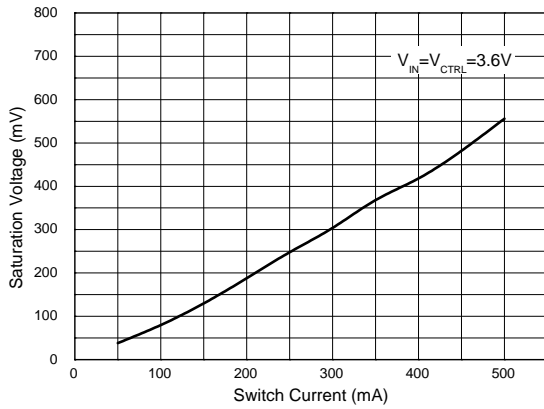

**CTRL Pin Voltage vs. Temperature**

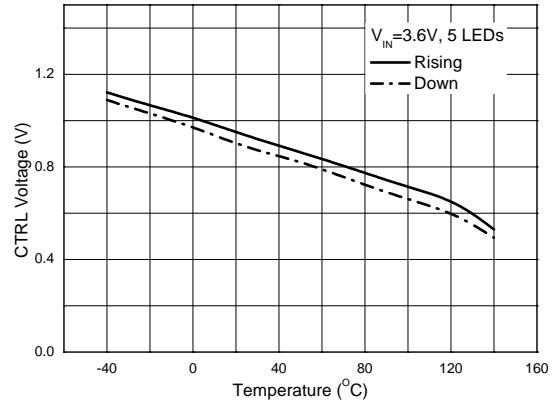

**OVP Voltage vs. Temperature**

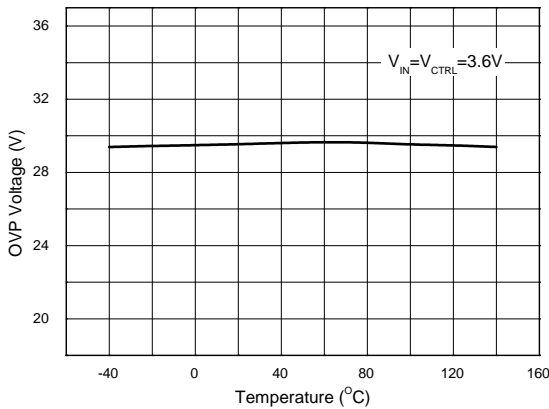

**Operating Frequency vs. Temperature**

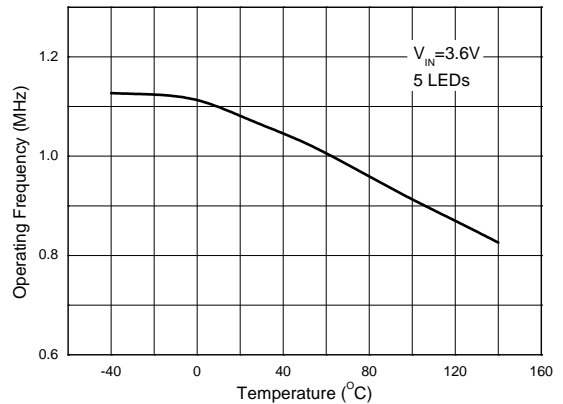

**Efficiency vs. Input Voltage**

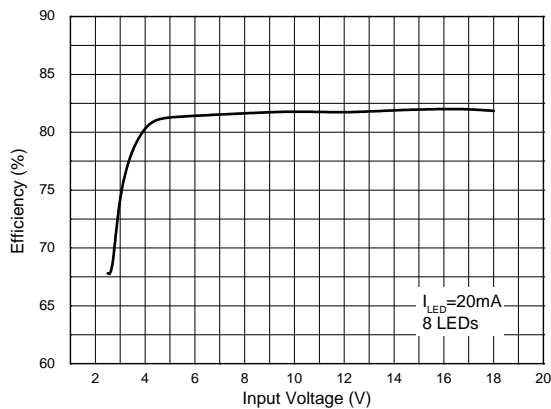

**Efficiency vs. Output Current**

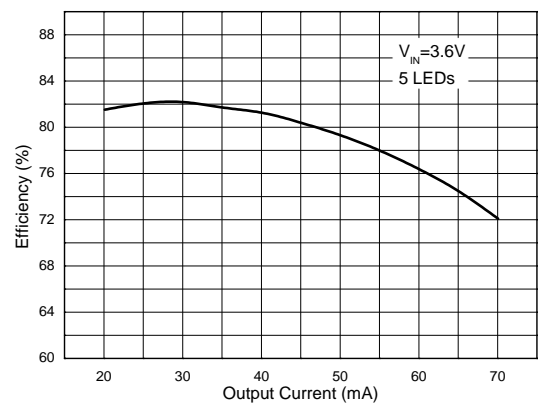

NEW PRODUCT

**Performance Characteristics** (Cont. The WLED forward voltage ( $V_F$ ) is 3.45V at  $I_F = 20\text{mA}$ , unless otherwise noted.)

**LED Current vs. Duty**

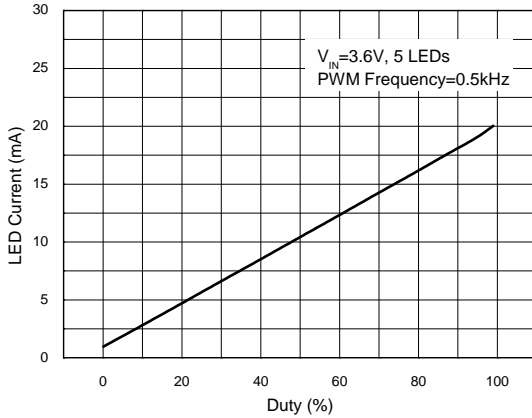

**LED Current vs. Duty**

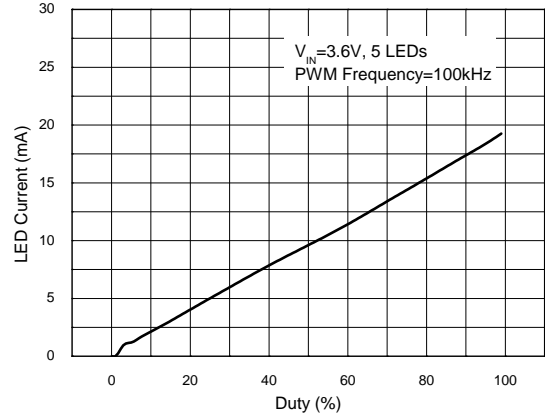

**Powering On**

( $V_{IN} = 3.6\text{V}$ ,  $V_{CTRL} = 2.5\text{V}$ ,  $I_{LED} = 20\text{mA}$ , 5 LEDs)

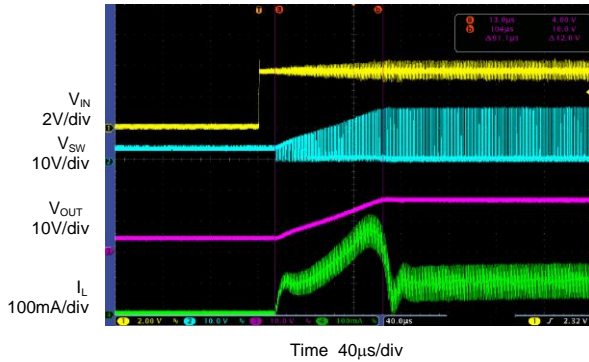

**PWM Dimming**

( $V_{IN} = 3.6\text{V}$ ,  $V_{PWM} = 2.5\text{V}$ ,  $f_{PWM} = 0.5\text{kHz}$ , Duty = 50%, 5 LEDs)

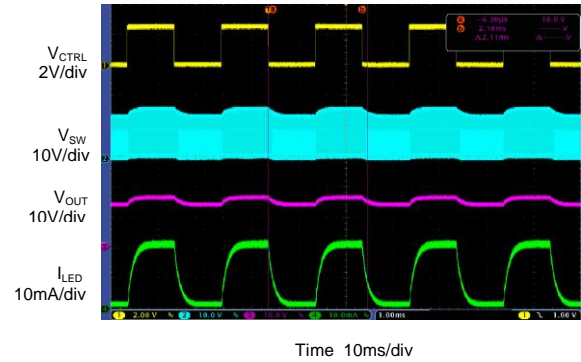

**Output Voltage Ripple**

( $V_{IN} = V_{CTRL} = 3.6\text{V}$ ,  $I_{LED} = 20\text{mA}$ , 5 LEDs)

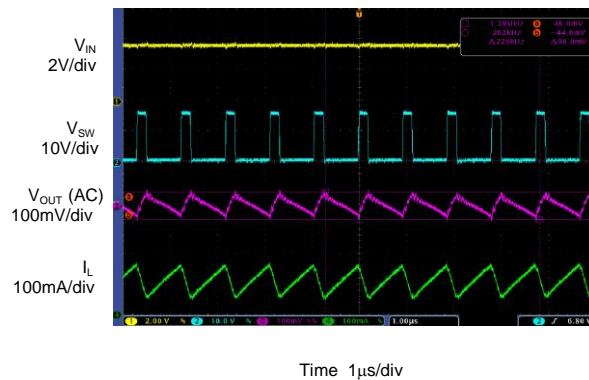

**PWM Dimming**

( $V_{IN} = 3.6\text{V}$ ,  $V_{PWM} = 2.5\text{V}$ ,  $f_{PWM} = 100\text{kHz}$ , Duty = 50%, 5 LEDs)

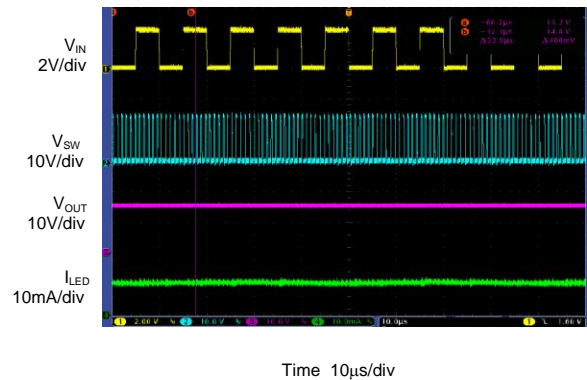

NEW PRODUCT

## Ordering Information

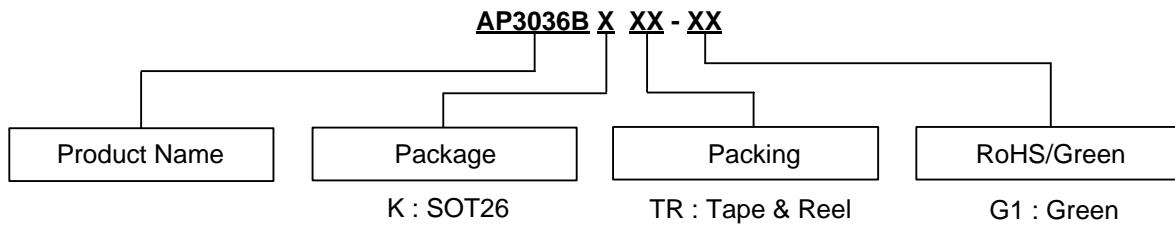



Diodes IC's Pb-free products with "G1" suffix in the part number, are RoHS compliant and green.

Package	Temperature Range	Part Number	Marking ID	Packing
SOT26	-40°C to +85°C	AP3036BKTR-G1	GHR	3000/7" Tape & Reel

## Marking Information

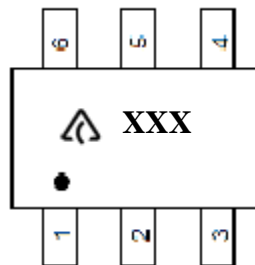
(Top View)



 : Logo  
**XXX**: Marking ID (See Ordering Information)



**Package Outline Dimensions** (All dimensions in mm(inch).)

(1) Package Type: SOT26

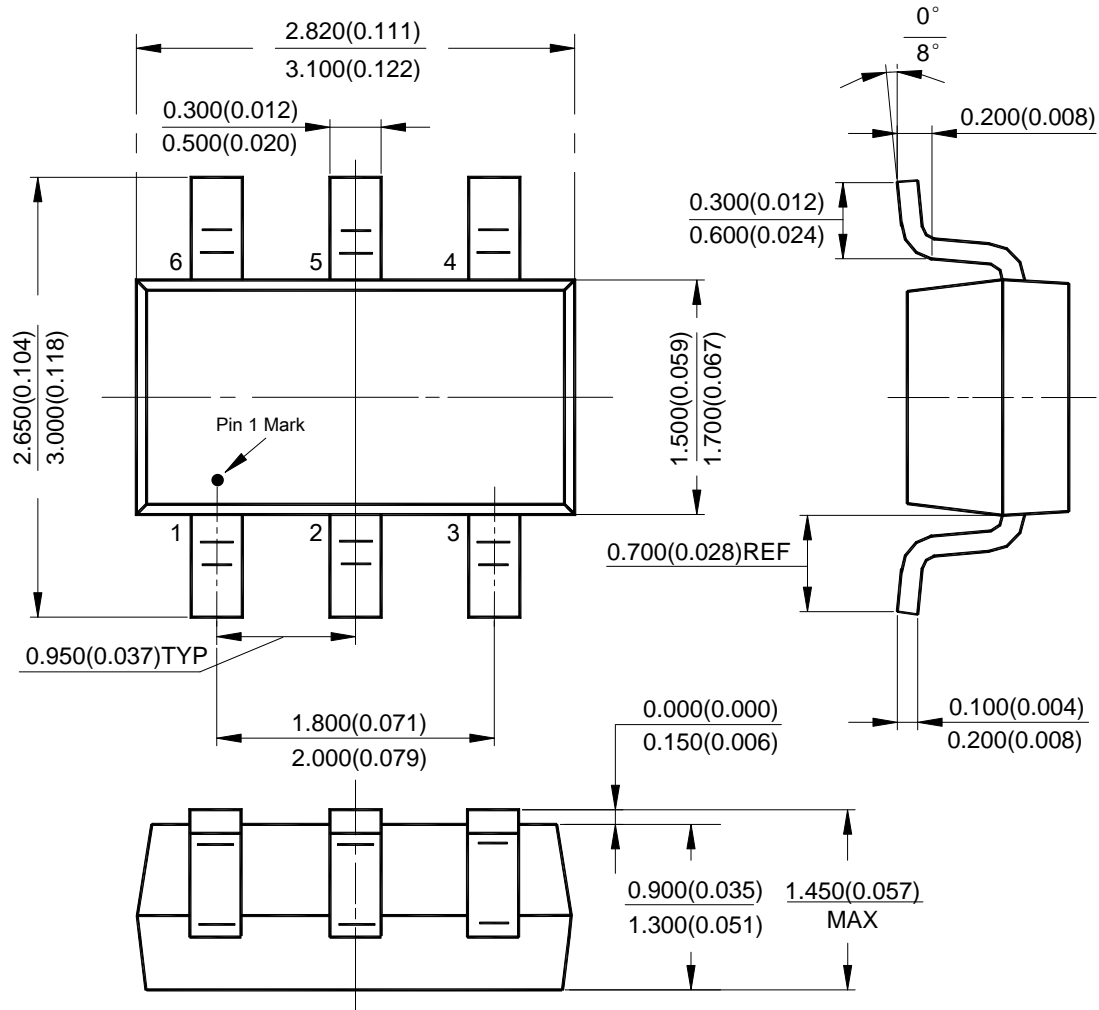

NEW PRODUCT

**Suggested Pad Layout**

(1) Package Type: SOT26

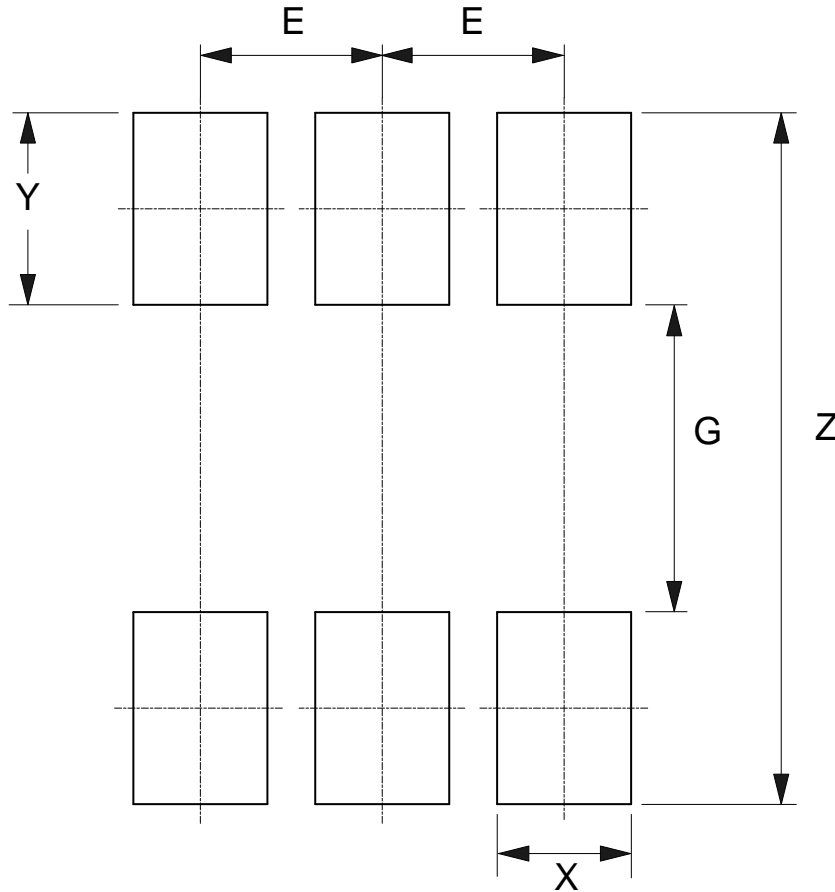

Dimensions	Z (mm)/(inch)	G (mm)/(inch)	X (mm)/(inch)	Y (mm)/(inch)	E (mm)/(inch)
Value	3.600/0.142	1.600/0.063	0.700/0.028	1.000/0.039	0.950/0.037

NEW PRODUCT

#### IMPORTANT NOTICE

DIODES INCORPORATED MAKES NO WARRANTY OF ANY KIND, EXPRESS OR IMPLIED, WITH REGARDS TO THIS DOCUMENT, INCLUDING, BUT NOT LIMITED TO, THE IMPLIED WARRANTIES OF MERCHANTABILITY AND FITNESS FOR A PARTICULAR PURPOSE (AND THEIR EQUIVALENTS UNDER THE LAWS OF ANY JURISDICTION).

Diodes Incorporated and its subsidiaries reserve the right to make modifications, enhancements, improvements, corrections or other changes without further notice to this document and any product described herein. Diodes Incorporated does not assume any liability arising out of the application or use of this document or any product described herein; neither does Diodes Incorporated convey any license under its patent or trademark rights, nor the rights of others. Any Customer or user of this document or products described herein in such applications shall assume all risks of such use and will agree to hold Diodes Incorporated and all the companies whose products are represented on Diodes Incorporated website, harmless against all damages.

Diodes Incorporated does not warrant or accept any liability whatsoever in respect of any products purchased through unauthorized sales channel. Should Customers purchase or use Diodes Incorporated products for any unintended or unauthorized application, Customers shall indemnify and hold Diodes Incorporated and its representatives harmless against all claims, damages, expenses, and attorney fees arising out of, directly or indirectly, any claim of personal injury or death associated with such unintended or unauthorized application.

Products described herein may be covered by one or more United States, international or foreign patents pending. Product names and markings noted herein may also be covered by one or more United States, international or foreign trademarks.

This document is written in English but may be translated into multiple languages for reference. Only the English version of this document is the final and determinative format released by Diodes Incorporated.

#### LIFE SUPPORT

Diodes Incorporated products are specifically not authorized for use as critical components in life support devices or systems without the express written approval of the Chief Executive Officer of Diodes Incorporated. As used herein:

A. Life support devices or systems are devices or systems which:

1. are intended to implant into the body, or
2. support or sustain life and whose failure to perform when properly used in accordance with instructions for use provided in the labeling can be reasonably expected to result in significant injury to the user.

B. A critical component is any component in a life support device or system whose failure to perform can be reasonably expected to cause the failure of the life support device or to affect its safety or effectiveness.

Customers represent that they have all necessary expertise in the safety and regulatory ramifications of their life support devices or systems, and acknowledge and agree that they are solely responsible for all legal, regulatory and safety-related requirements concerning their products and any use of Diodes Incorporated products in such safety-critical, life support devices or systems, notwithstanding any devices- or systems-related information or support that may be provided by Diodes Incorporated. Further, Customers must fully indemnify Diodes Incorporated and its representatives against any damages arising out of the use of Diodes Incorporated products in such safety-critical, life support devices or systems.

Copyright © 2014, Diodes Incorporated

[www.diodes.com](http://www.diodes.com)