

4-String White LED Driver with Boost Regulator

General Description

The RT8575 is a high efficiency LED driver with 40V I/O support. It is designed for LCD panel that employs an array of LEDs as the lighting source. An integrated switch current mode Boost controller drives four strings in parallel and supports up to 18 pieces of LEDs per string. The internal current sinks support typical $\pm 1\%$ current mismatching for excellent brightness uniformity in each LED string. To provide enough headroom for the operating of current sink, Boost controller monitors the minimum voltage of feedback pins and regulates an optimized output voltage for power efficiency.

The RT8575 has a wide input voltage operating range from 4.2V to 24V and provides adjustable 50mA to 150mA LED current. The internal 150m Ω , 60V power switch with current-mode control provides cycle-by-cycle over current protection. RT8575 also integrates PWM dimming function for accurate LED current control. The input PWM dimming frequency can operate from 120Hz to 1kHz without inducing any inrush current in LEDs or inductor. The switching frequency of RT8575 is adjustable from 150kHz to 500kHz, which allows the trade-off between efficiency and component size.

The RT8575 is available in WDFN-16L 5x5 and DIP-16 (BW) packages to achieve optimized solution for PCB space.

Features

- Input Operating Voltage Range 4.2V to 24V
- 60V Maximum Output Voltage
- Adjustable Switching Frequency : 150kHz to 500kHz
- Support Up to 4 LED Strings
- 50mA to 150mA LED Current Per Channel
- 1% Typical LED Current Accuracy
- 1% Typical LED Current Matching
- Programmable Over Voltage Protection
- Built-in Soft-Start, OTP
- LED Short/Open Detection
- RoHS Compliant and Halogen Free

Applications

- White LED Backlighting

Ordering Information

RT8575	□	□	Package Type
			QW : WDFN-16L 5x5 (W-Type)
			N : DIP-16 (BW)
			Lead Plating System
			G : Green (Halogen Free and Pb Free)

Note :

Richtek products are :

- ▶ RoHS compliant and compatible with the current requirements of IPC/JEDEC J-STD-020.
- ▶ Suitable for use in SnPb or Pb-free soldering processes.

Simplified Application Circuit

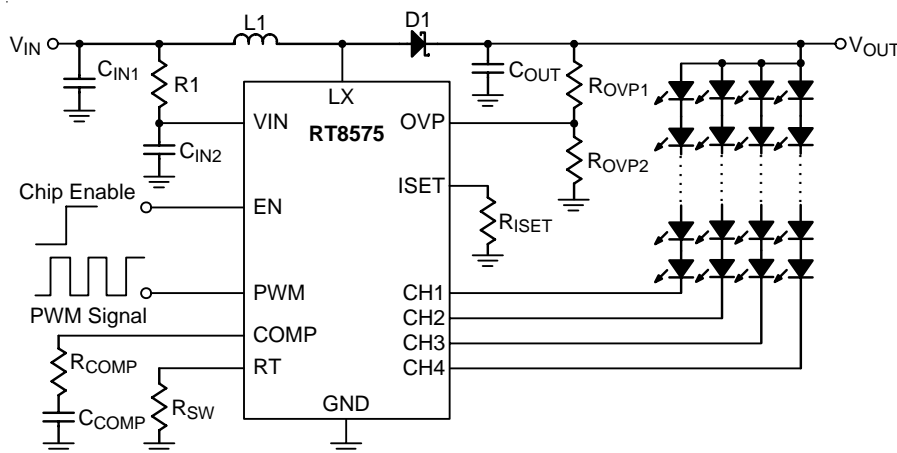

Marking Information

RT8575GQW

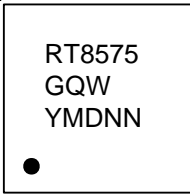

RT8575GQW : Product Number
YMDNN : Date Code

RT8575GN



RT8575GN : Product Number
YMDNN : Date Code

Pin Configurations

(TOP VIEW)

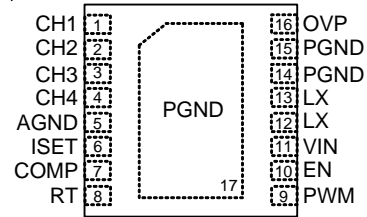

WDFN-16L 5x5

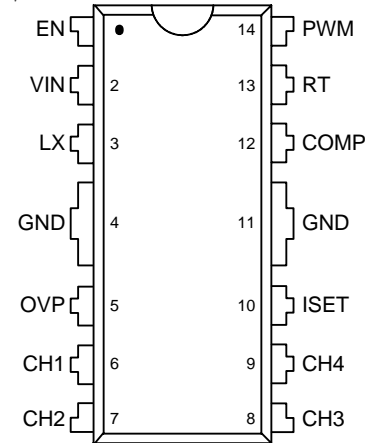

DIP-16 (BW)

Functional Pin Description

Pin No.		Pin Name	Pin Function
WDFN-16L 5x5	DIP-16 (BW)		
1 to 4	6 to 9	CH1 to CH4	Current Sink for LED. (Connect to GND, if not used)
5	--	AGND	Analog Ground.
6	10	ISET	LED current is set by the value of the resistor R_{ISET} connected from the ISET pin to ground. Do not short the ISET pin. V_{ISET} is typically 1V.
7	12	COMP	Compensation Pin for Error Amplifier. Connect a compensation network to ground.
8	13	RT	Switching Frequency Selection Input. The switching frequency is adjustable from 150kHz to 500kHz.
9	14	PWM	Dimming Control Input.
10	1	EN	Chip Enable (Active High). Note that this pin is high impedance. There should be a 100k Ω pull low resistor connected to GND when the control signal is floating.
11	2	VIN	Power Supply Input.
12, 13	3	LX	The Switching Pin for Boost Converter.
14, 15, 17 (Exposed Pad)	--	PGND	Power Ground of Boost Converter. The exposed pad must be soldered to a large PCB and connected to PGND for maximum power dissipation.
16	5	OVP	Over Voltage Protection for Boost Converter. The detecting threshold is 1.2V.
--	4, 11	GND	Ground.

Function Block Diagram

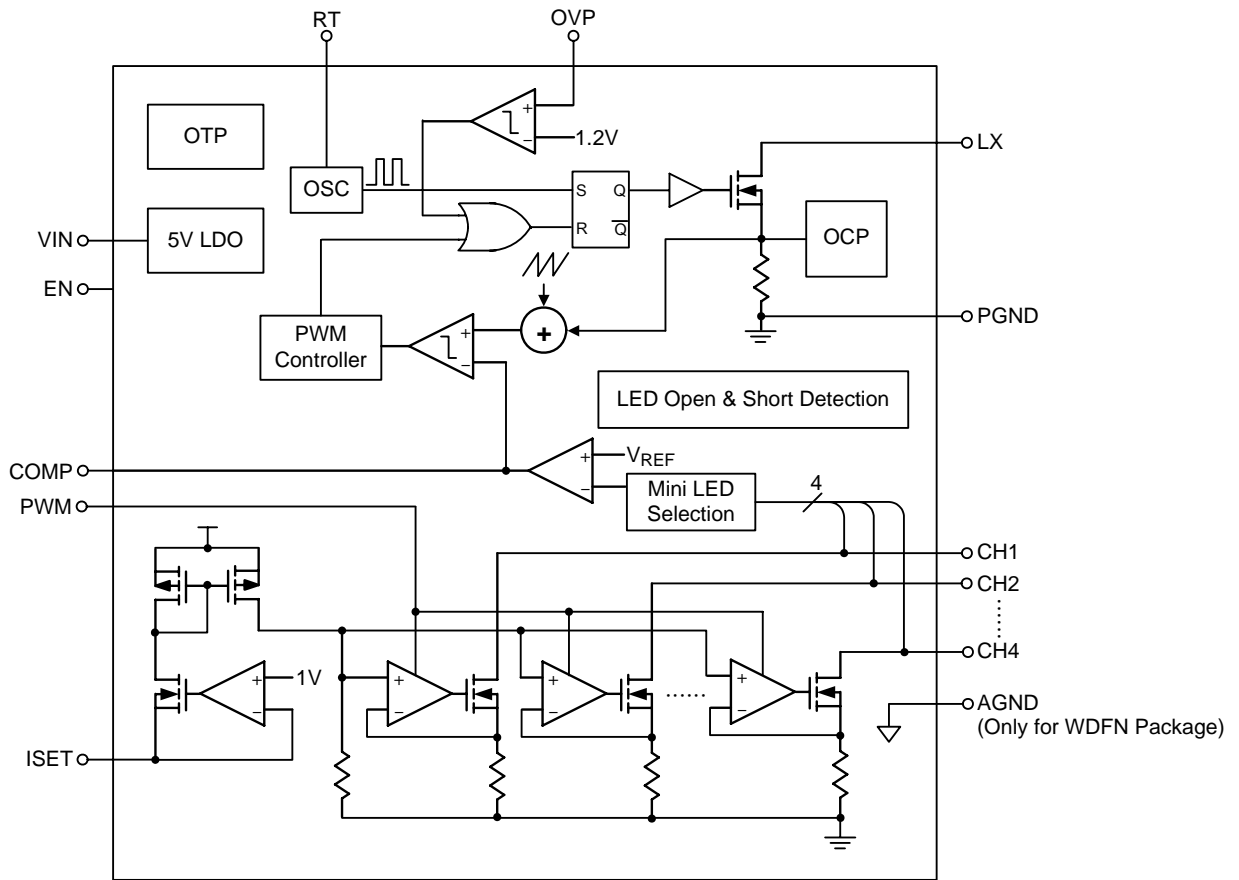

Operation

The RT8575 integrates 4 linear LED drivers and a Boost converter. When EN is High and V_{IN} is higher than the voltage of UVLO, the RT8575 will start operation and detect which channels are using. If the channel is connected to ground, it would be defined as un-used channel. And the driver of this channel will be turned off after the un-used checking.

Then, RT8575 will enter the soft-start mode. V_{ISET} will increase to be 1V slowly, which represents that the I_{LED} also increases slowly. Beside that the OCP is clamped

at lower level, just prevents a large inrush current. RT8575 will choose the min. value of V_{LED} as the feedback voltage of Boost converter, the un-used channel is out of the list.

During normal operation, when LED string is defined as short, the driver of that channel will be turned off. In order to protect the system, "SHORT" status of the channel should only be released by re-start of the system. When LED string is defined as open, the driver of that channel will be turned off, and auto-recovery when "OPEN" is released.

Absolute Maximum Ratings (Note 1)

- Supply Input Voltage, VIN to GND ----- -0.3V to 44V
- EN, ISET, COMP, OVP, RT to GND ----- -0.3V to 44V
- CH1 to CH4, LX to GND ----- -0.3V to 66V
- Power Dissipation, PD @ TA = 25°C
 - WDFN-16L 5x5 ----- 3.47W
 - DIP-16 (BW) ----- 1.8W
- Package Thermal Resistance (Note 2)
 - WDFN-16L 5x5, θJA ----- 28.8°C/W
 - WDFN-16L 5x5, θJC ----- 4.4°C/W
 - DIP-16 (BW), θJA ----- 55.7°C/W
 - DIP-16 (BW), θJC ----- 8.3°C/W
- Lead Temperature (Soldering, 10 sec.) ----- 260°C
- Junction Temperature ----- 150°C
- Storage Temperature Range ----- -65°C to 150°C
- ESD Susceptibility (Note 3)
 - HBM (Human Body Model) ----- 2kV
 - MM (Machine Model) ----- 200V

Recommended Operating Conditions (Note 4)

- Supply Input Voltage, VIN ----- 4.2V to 24V
- Junction Temperature Range ----- -40°C to 125°C
- Ambient Temperature Range ----- -40°C to 85°C

Electrical Characteristics

(VIN = 19V, CIN2 = 1μF, TA = 25°C, unless otherwise specified)

Parameter	Symbol	Test Conditions	Min	Typ	Max	Unit
Input Supply Voltage	VIN		4.2	--	24	V
Under Voltage Lockout Threshold	VUVLO	VIN Rising	--	3.8	--	V
Under Voltage Lockout Hysteresis	DVUVLO		--	500	--	mV
Quiescent Current	IVCC	COMP = 0V, Not Switching	--	2.5	--	mA
	IVCC_SW	COMP = 2V, Switching	--	3.3	--	
Shutdown Current	ISHDN	VIN = 4.5V, EN = 0	--	--	20	μA
EN, PWM Input Voltage	Logic-High	VIH	VIN = 4.2V to 24V	2	--	V
	Logic-Low	VIL	VIN = 4.2V to 24V	--	--	
PWM Dimming Frequency	FPWM		120	--	1k	Hz
Switching Frequency	FOSC	R _{SW} = 51.1kΩ	224	280	336	kHz
LX On-Resistance (N-MOSFET)	RLX	VIN > 4.5V	--	0.15	--	Ω
Minimum On-Time	T _{MON}		--	220	--	ns
Maximum Duty	D _{MAX}	V _{COMP} = 2V, Switching	--	92	--	%
LX Current Limit	ILIM		2.8	3.3	3.8	A

Parameter	Symbol	Test Conditions	Min	Typ	Max	Unit
LED Current Accuracy	I _{LEDA}	0.4V < CHx < 2V, R _{ISET} = 7.5kΩ	116.4	120	123.6	mA
LED Current Matching	I _{LEDM}	0.4V < CHx < 2V, R _{ISET} = 7.5kΩ	--	±1	±3	%
ISET Pin Voltage	V _{ISET}		--	1	--	V
OVP Threshold	V _{OVP}		1.17	1.2	1.23	V
Thermal Shutdown Temperature	T _{OTP}		--	150	--	°C
Thermal Shutdown Hysteresis	T _{OTP_hys}		--	20	--	°C
Un-Connected LED Detection	V _{USE}	Un-Connection	--	0.2	--	V
Opened LED Protection	V _{OLP}		--	0.1	--	V
Shorted LED Protection	V _{SLP}		--	5.6	--	V
Shutdown Delay Time	T _{SD}	f _{OSC} = 280kHz	--	28	--	ms

Note 1. Stresses beyond those listed “Absolute Maximum Ratings” may cause permanent damage to the device. These are stress ratings only, and functional operation of the device at these or any other conditions beyond those indicated in the operational sections of the specifications is not implied. Exposure to absolute maximum rating conditions may affect device reliability.

Note 2. θ_{JA} is measured at T_A = 25°C on a high effective thermal conductivity four-layer test board per JEDEC 51-7. θ_{JC} is measured at the exposed pad of the package.

Note 3. Devices are ESD sensitive. Handling precaution is recommended.

Note 4. The device is not guaranteed to function outside its operating conditions.

Typical Application Circuit

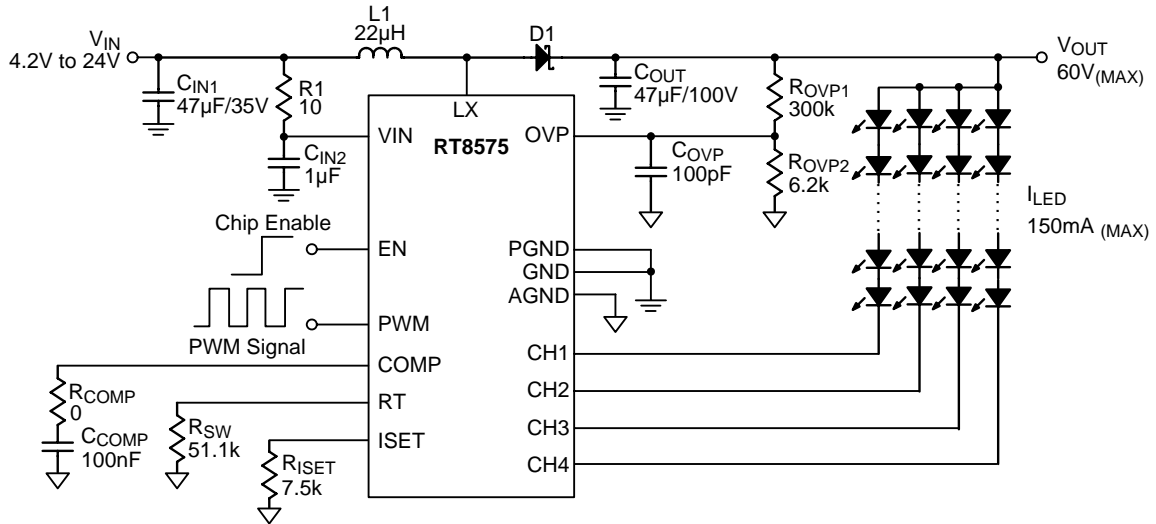

Typical Operating Characteristics

Efficiency vs. Input Voltage

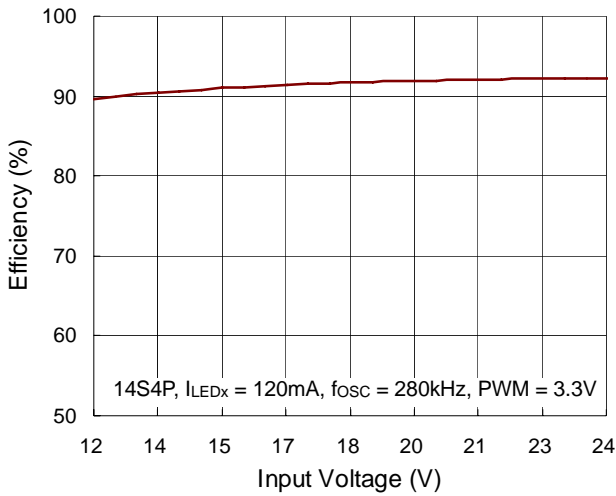

Efficiency vs. Input Voltage

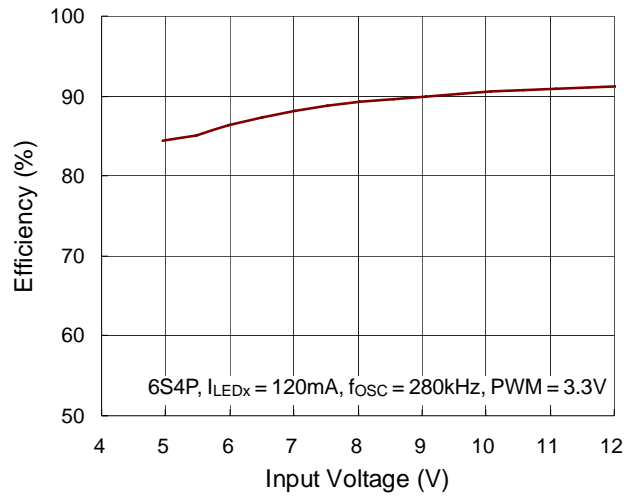

LED Current vs. Input Voltage

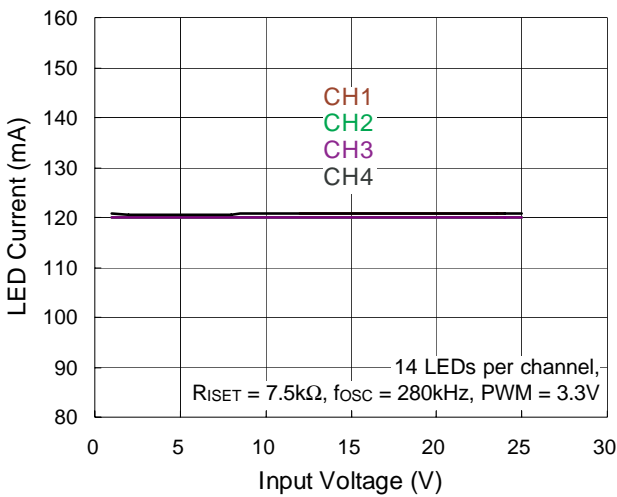

LED Current vs. Input Voltage

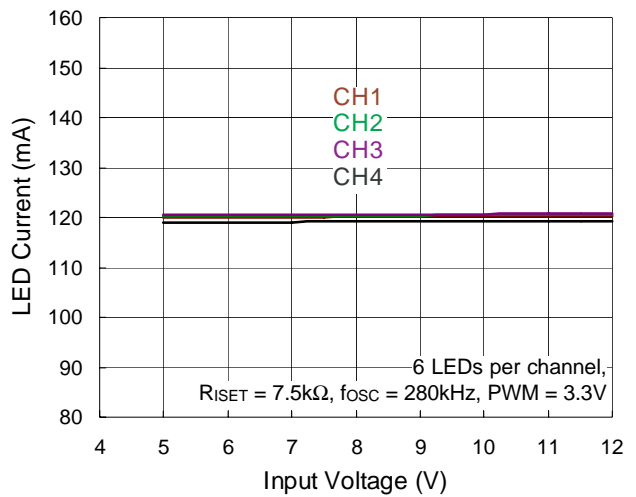

LED Current vs. Temperature

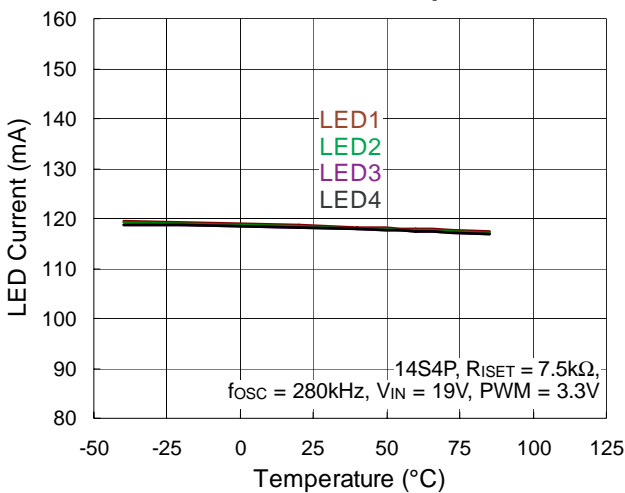

LED Current vs. Dimming Duty

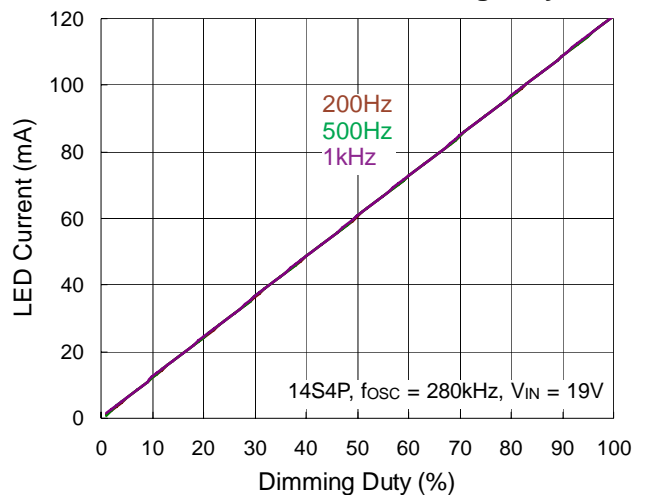

OVP Voltage vs. Input Voltage

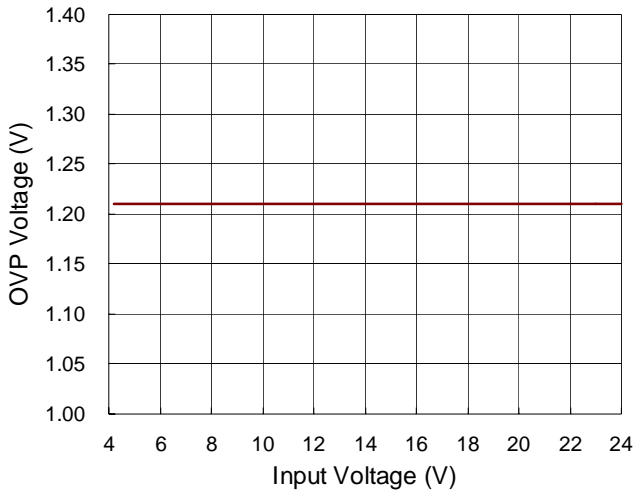

Quiescent Current vs. Input Voltage

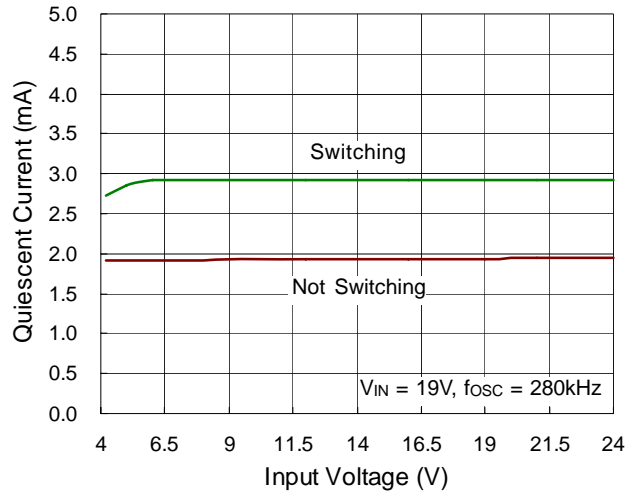

Quiescent Current vs. Temperature

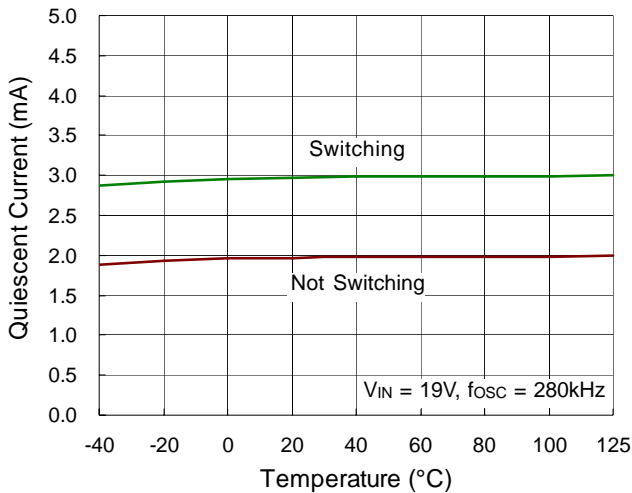

LED Current vs. R_{ISSET}

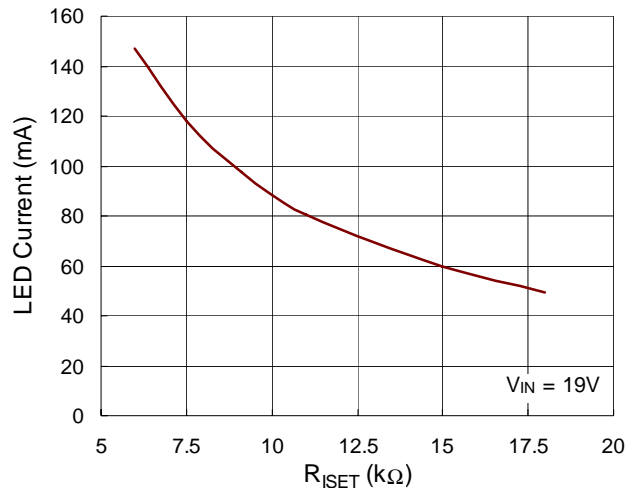

Switching Frequency vs. R_{sw}

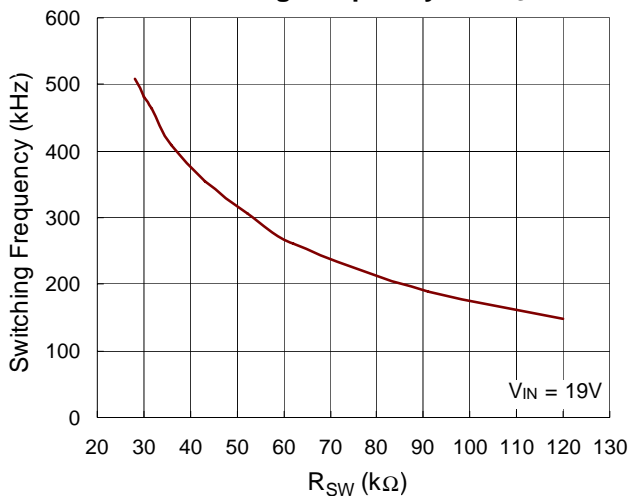

Line Transient Response

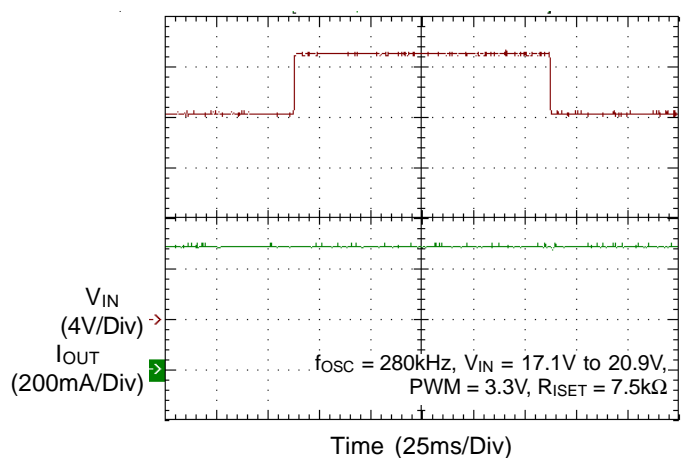

Power On from PWM

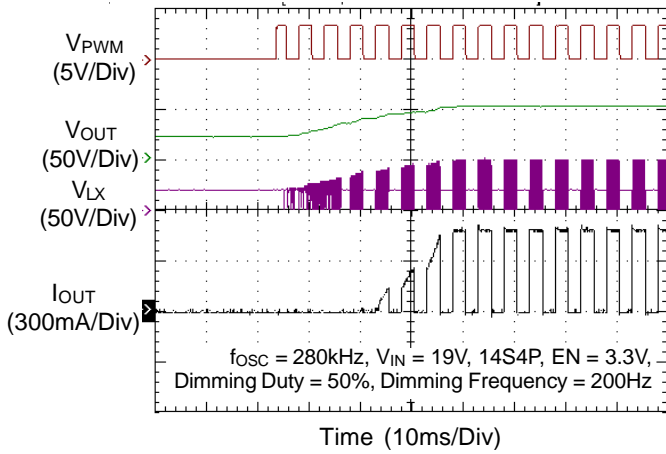

Power Off from PWM

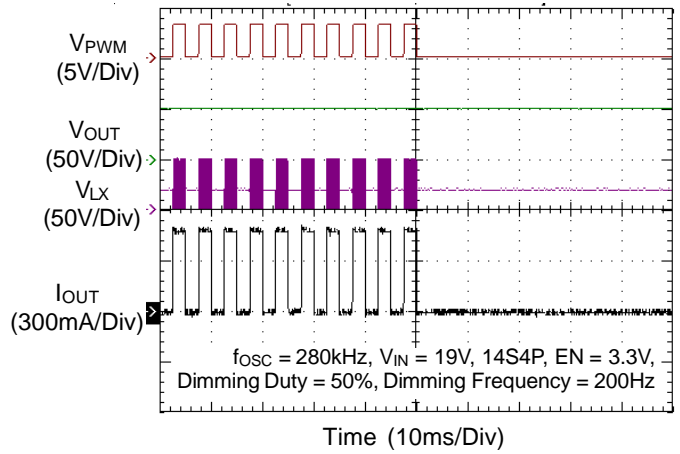

Power On from EN

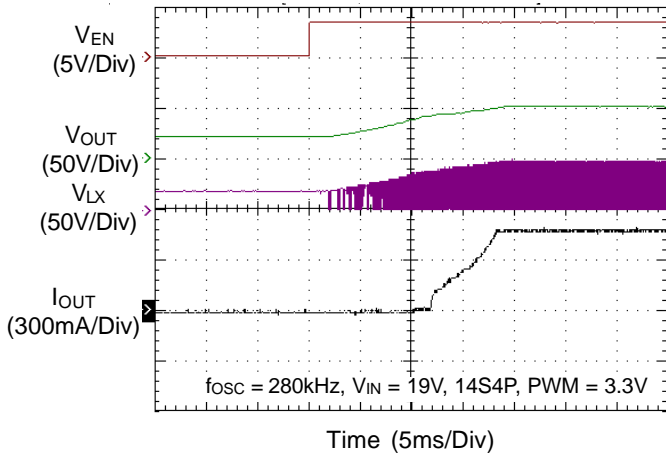

Power Off from EN

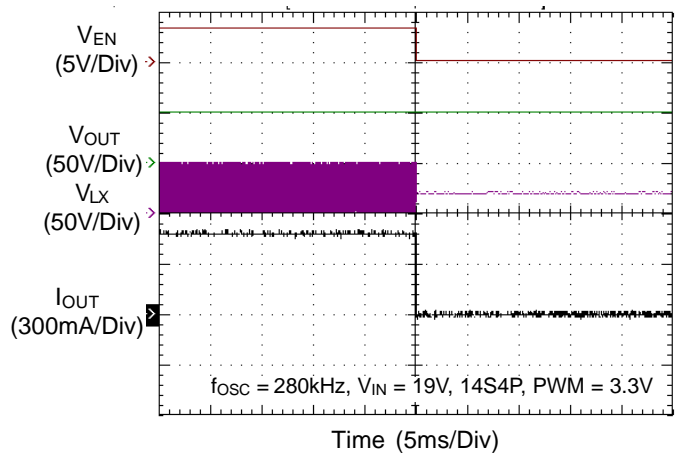

Power On from VIN

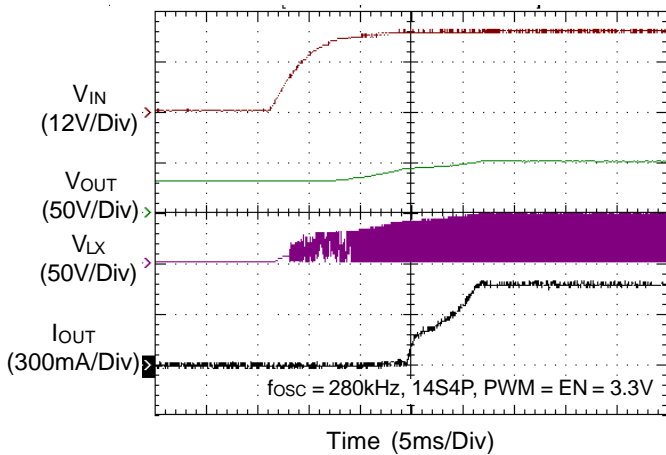

Power Off from VIN

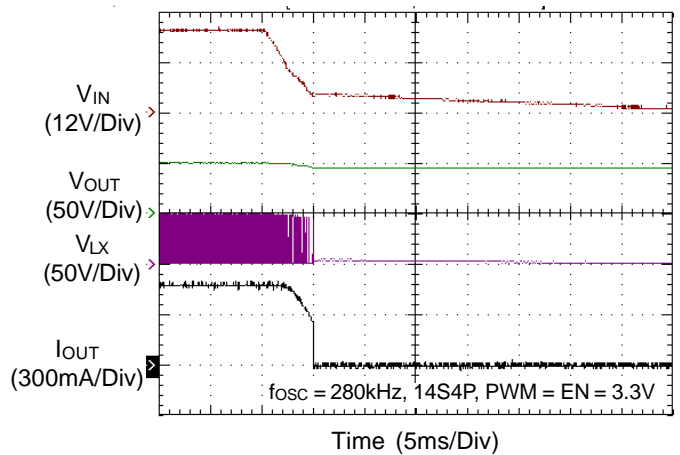

Application Information

The RT8575 is a general purpose 4-CH LED driver capable of delivering an adjustable 50mA to 150mA LED current. The IC is a current mode Boost converter integrated with a 60V/4A power switch and can cover a wide V_{IN} range from 4.2V to 24V. The switching frequency is adjustable by an external resistor from 150kHz to 500kHz. The part integrates built-in soft-start, with PWM dimming control; moreover, it provides over voltage, over temperature, short LED and cycle-by-cycle over current protection features.

Supply Voltage Capacitor Selection

The RT8575 equips a built-in LDO linear regulator to provide the internal logic of IC power. The output of LDO is the pin out of VIN. The VIN pin is recommended to connect at least a 1 μ F/25V bypass capacitor. The bypass capacitor should be used with X5R or X7R type, to assure the bypass capacitance remains stable in over voltage or over temperature.

Soft-Start

The RT8575 equips a soft-start feature to prevent high inrush current during start-up. The soft-start function prevents excessive input current and input voltage droop during power on state.

LED Current Setting

LED current of each channel can be calculated by following equation :

$$I_{LED} \cong \frac{900}{R_{ISET}}$$

Where the R_{ISET} resistor is connected between the ISET pin and GND. This setting is the reference for the LED current at the LED pin and represents the sensed LED current for each string. The LED driver regulates the LED current according to the setting.

Switching Frequency

The LED driver switching frequency is adjusted by the external resistor, R_{SW} . The switching frequency can be calculated by the following equation :

$$f_{OSC} \cong \frac{14.3 \times 10^9}{R_{SW}}$$

Compensation

The regulator loop can be compensated by adjusting the external components connected to the COMP pin. The COMP pin is the output of the internal error amplifier. The compensation capacitor will adjust the integrator zero to maintain stability and the resistor value will adjust the frequency integrator gain for fast transient response. Typical values of the compensation components are $R_{COMP} = 0\Omega$, $C_{COMP} = 100nF$.

LED Connection

The RT8575 equips 4-CH LED drivers and each channel supports up to 18 LEDs ($V_f = 3V$). The LED strings are connected from the output of the Boost converter to pin CHx (x = 1 to 4) respectively. If one of the current sink channels is not used, the CHx pin should be connected to GND. If the un-used channel is not connected to GND, it will be considered that the LED string is opened, the channel will turn light when the LED string is recovering connected.

Over Voltage Protection

The RT8575 integrates over voltage protection. When the voltage at the OVP pin rises above the threshold voltage of approximately 1.2V, The internal switch will be turned off. Once the voltage of OVP pin drop below its threshold voltage, the internal switch will be turned on again. The output voltage can be clamped at a certain voltage level and can be calculated by the following equations :

$$V_{OUT(OVP)} \cong V_{OVP} \times \left(1 + \frac{R_{OVP1}}{R_{OVP2}} \right)$$

where $V_{OVP} = 1.2V$ (typ.).

R_{OVP1} and R_{OVP2} are the resistors in the voltage divider connected to the OVP pin. If at least one string is in normal operation, the controller will automatically ignore the open strings and continue to regulate the current for the strings in normal operation. It is suggested to use near 300k Ω for R_{OVP1} , and use a 100pF bypass capacitor at R_{OVP2} .

Current Limit Protection

The RT8575 can limit the peak current to achieve over current protection. The RT8575 senses the inductor current during the "ON" period that flows through the LX

pin. The duty cycle depends on the current signal and internal slope compensation in comparison with the error signal. The internal switch of Boost converter will be turned off when the peak current value of inductor current is larger than the threshold current 3.3A (typ.). In the "OFF" period, the inductor current will be decreased until the internal switch is turned on by the oscillator.

Brightness Control

The RT8575 features a digital dimming control scheme. A very high contrast ratio true digital PWM dimming is achieved by driving the PWM pin with a PWM signal. The recommended PWM frequency is 120Hz to 1kHz. The LED current can be approximately 100% proportional to duty cycle, but the linearity is not ideal on the high frequency and lower duty ratio.

Over Temperature Protection

The RT8575 has over temperature protection function to prevent the IC from overheating due to excessive power dissipation. The OTP function will shut down the IC when junction temperature exceeds 150°C. When junction temperature cools down to 130°C ($T_{OTP_hys} = 20^{\circ}C$), the LED driver will return to normal work.

Short LED Protection

The RT8575 integrates Short LED Protection (SLP). If one or more of the CH1 to CH4 pin voltages exceeds the threshold of approximately 5.6V during normal operation, the channels will be closed and latch. If the LED of all channels is shorted circuit, the internal switch of Boost converter will be turned off.

Open LED Protection

If the CHx pin voltage is low at 0.1V, the LED driver will determine whether the channel is open. The CHx pin voltage will not be regulated and not latch, until the CHx pin is recovering connected, the CHx pin will start normal work again. If all CHx pins are open (floating), the output voltage will be clamped to the setting voltage of OVP ($V_{OUT(OVP)}$).

Power On/Off Sequence

LED driver is without power sequence concern. Mode1, Mode2 and Mode3 are different power sequences respectively. There is no concern in the above condition.

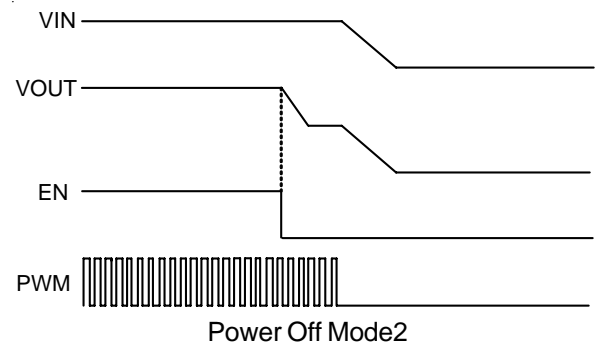
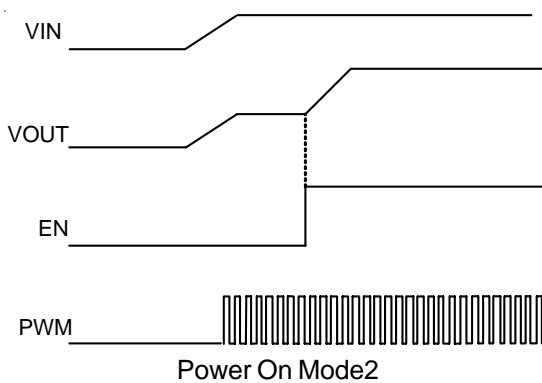
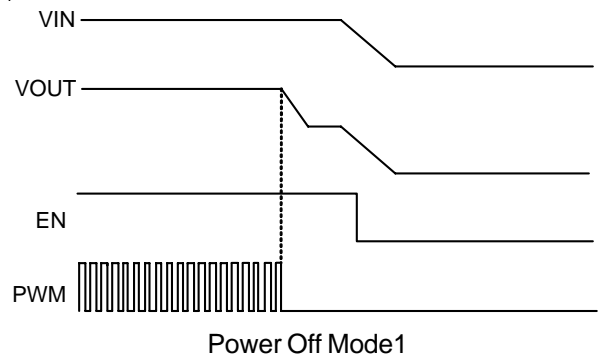
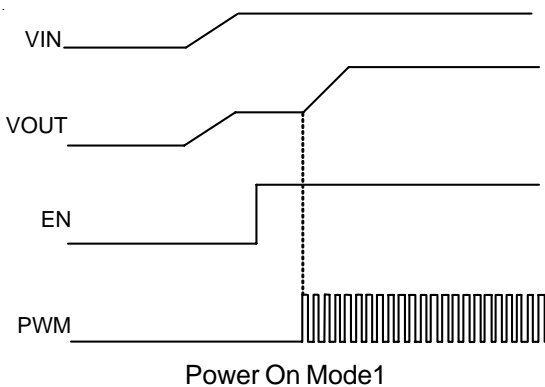

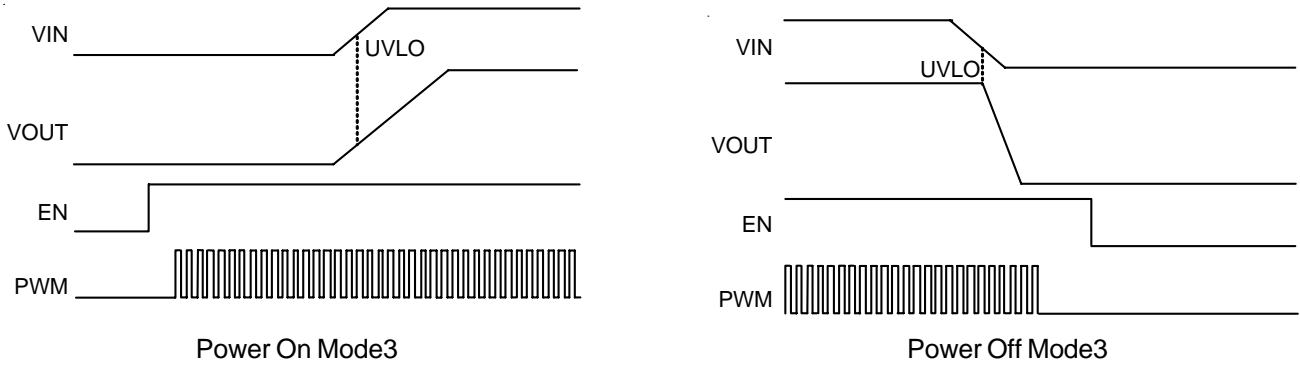

Figure 1. Power On/Off Sequence

Shutdown Delay Time

The EN shutdown delay is about 32ms, it is intended to prevent the glitch of EN. When EN has glitch happening ($T_{glitch} < 32ms$), the IC will not need to recover soft-start again. But the LED current sources will be closed immediately. And after about 32ms, the IC will be shut down. Please refer to the Figure 2.

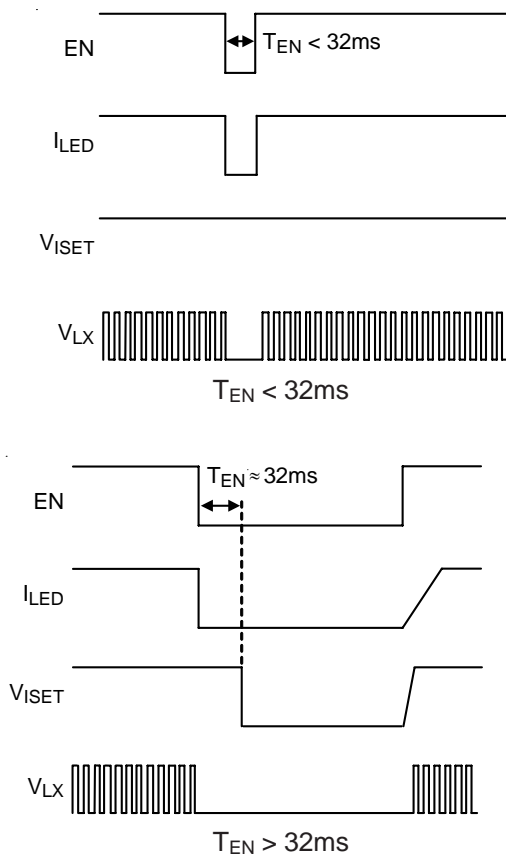

Figure 2. Shutdown Delay Time

Inductor Selection

The value of the inductance, L, can be approximated by the following equation, where the transition is from Discontinuous Conduction Mode (DCM) to Continuous Conduction Mode (CCM) :

$$L = \frac{D \times (1-D)^2 \times V_{OUT}}{2 \times f_{OSC} \times I_{OUT}}$$

The duty cycle, D, can be calculated as the following equation :

$$D = \frac{V_{OUT} - V_{IN}}{V_{OUT}}$$

Where V_{OUT} is the maximum output voltage, V_{IN} is the minimum input voltage, f_{OSC} is the operating frequency, and I_{OUT} is the sum of current from all LED strings. The Boost converter operates in DCM over the entire input voltage range when the inductor value is less than this value, L. With an inductance greater than L, the converter operates in CCM at the minimum input voltage and may be discontinuous at higher voltages.

The inductor must be selected with a saturated current rating that is greater than the peak current as provided by the following equation :

$$I_{PEAK} = \frac{V_{OUT} \times I_{OUT}}{\eta \times V_{IN}} + \frac{V_{IN} \times D \times T_{OSC}}{2 \times L}$$

where η is the efficiency of the power converter.

Diode Selection

Schottky diodes are recommended for most applications because of their fast recovery time and low forward voltage. Power dissipation, reverse voltage rating, and pulsating

peak current are important parameters for consideration when making a Schottky diode selection. Make sure that the diode's peak current rating exceeds I_{PEAK} and reverse voltage rating exceeds the maximum output voltage.

Input Capacitor Selection

Low ESR electrolytic capacitors are recommended for input capacitor applications. Low ESR will effectively reduce the input voltage ripple caused by switching operation. A 47μF/35V is sufficient for most applications. Nevertheless, this value can be decreased for lower output current requirement. Another consideration is the voltage rating of the input capacitor must be greater than the maximum input voltage.

Output Capacitor Selection

Output ripple voltage is an important index for estimating the performance. This portion consists of two parts, one is the ESR voltage of output capacitor, the other part is formed by charging and discharging process of output capacitor. Refer to Figure 3, evaluate ΔV_{OUT1} by ideal energy equalization. According to the definition of Q, the Q value can be calculated as following equation :

$$Q = \frac{1}{2} \times \left[\left(I_{IN} + \frac{1}{2} \Delta I_L - I_{OUT} \right) + \left(I_{IN} - \frac{1}{2} \Delta I_L - I_{OUT} \right) \right] \times \frac{V_{IN}}{V_{OUT}} \times \frac{1}{f_{OSC}} = C_{OUT} \times \Delta V_{OUT1}$$

where f_{OSC} is the switching frequency, and ΔI_L is the inductor ripple current. Move C_{OUT} to the left side to estimate the value of ΔV_{OUT1} as the following equation :

$$\Delta V_{OUT1} = \frac{D \times I_{OUT}}{\eta \times C_{OUT} \times f_{OSC}}$$

Then, take the ESR into consideration, the ESR voltage can be determined as the following equation :

$$\Delta V_{ESR} = \left(\frac{I_{OUT}}{1-D} + \frac{V_{IN} \times D \times T_{OSC}}{2L} \right) \times R_{ESR}$$

Finally, the total output ripple ΔV_{OUT} is combined from the ΔV_{OUT1} and ΔV_{ESR} . In the general application, the output capacitor is recommended to use a 47μF/63V electrolytic capacitor.

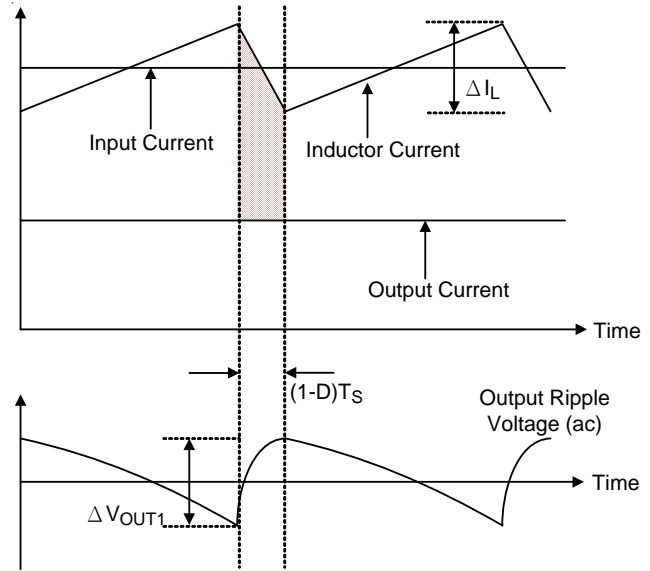

Figure 3. The Output Ripple Voltage without the Contribution of ESR

Thermal Considerations

For continuous operation, do not exceed absolute maximum junction temperature. The maximum power dissipation depends on the thermal resistance of the IC package, PCB layout, rate of surrounding airflow, and difference between junction and ambient temperature. The maximum power dissipation can be calculated by the following formula :

$$P_{D(MAX)} = (T_{J(MAX)} - T_A) / \theta_{JA}$$

where $T_{J(MAX)}$ is the maximum junction temperature, T_A is the ambient temperature, and θ_{JA} is the junction to ambient thermal resistance.

For recommended operating condition specifications, the maximum junction temperature is 125°C. The junction to ambient thermal resistance, θ_{JA} , is layout dependent. For WDFN-16L 5x5 package, the thermal resistance, θ_{JA} , is 28.8°C/W on a standard JEDEC 51-7 four-layer thermal test board. For DIP-16 (BW) package, the thermal resistance, θ_{JA} , is 55.7°C/W on a standard JEDEC 51-7 four-layer thermal test board. The maximum power dissipation at $T_A = 25^\circ\text{C}$ can be calculated by the following formula :

$$P_{D(MAX)} = (125^\circ\text{C} - 25^\circ\text{C}) / (28.8^\circ\text{C/W}) = 3.47\text{W for WDFN-16L 5x5 package}$$

$P_{D(MAX)} = (125^{\circ}\text{C} - 25^{\circ}\text{C}) / (55.7^{\circ}\text{C}/\text{W}) = 1.8\text{W}$ for DIP-16 (BW) package

The maximum power dissipation depends on the operating ambient temperature for fixed $T_{J(MAX)}$ and thermal resistance, θ_{JA} . The derating curve in Figure 4 allow the designer to see the effect of rising ambient temperature on the maximum power dissipation.

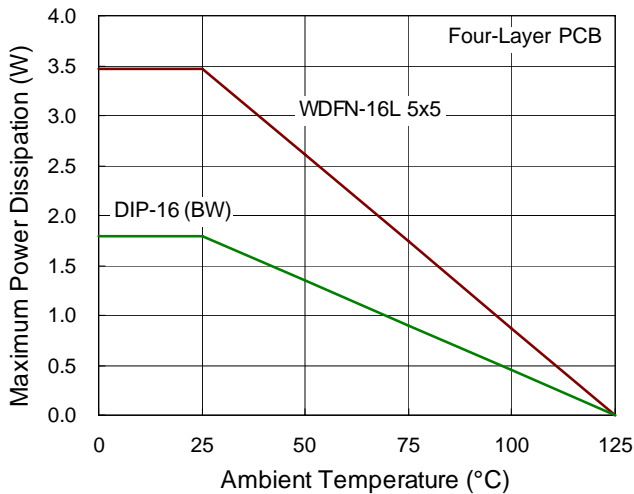

Figure 4. Derating Curve of Maximum Power Dissipation

Layout Consideration

PCB layout is very important for designing switching power converter circuits. The following layout guides should be strictly followed for best performance of the RT8575.

- ▶ The power components, L1, D1, C_{IN1} and C_{OUT} must be placed as close as possible to reduce power loop. The PCB trace between power components must be as short and wide as possible.
- ▶ Place L1 and D1 as close as possible to LX pin. The trace should be as short and wide as possible.
- ▶ The compensation circuit (R_{COMP}, C_{COMP}) should be kept away from the power loops and should be shielded with a ground trace to prevent any noise coupling. Place the compensation components as close as possible to COMP pin.
- ▶ The LED current setting resistor (R_{ISET}) should be kept away from the power loops and should be shielded with a ground trace. Place the LED current resistor as close as possible to ISET pin.

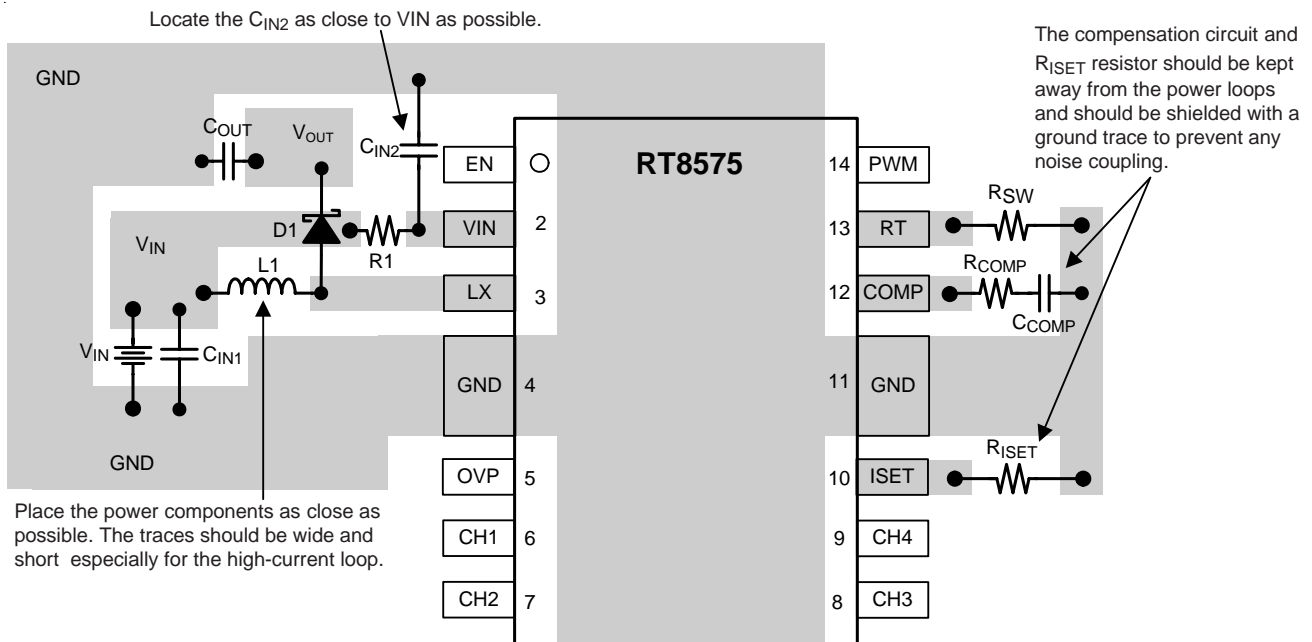

Figure 5. PCB Layout Guide for DIP-16 (BW) Package

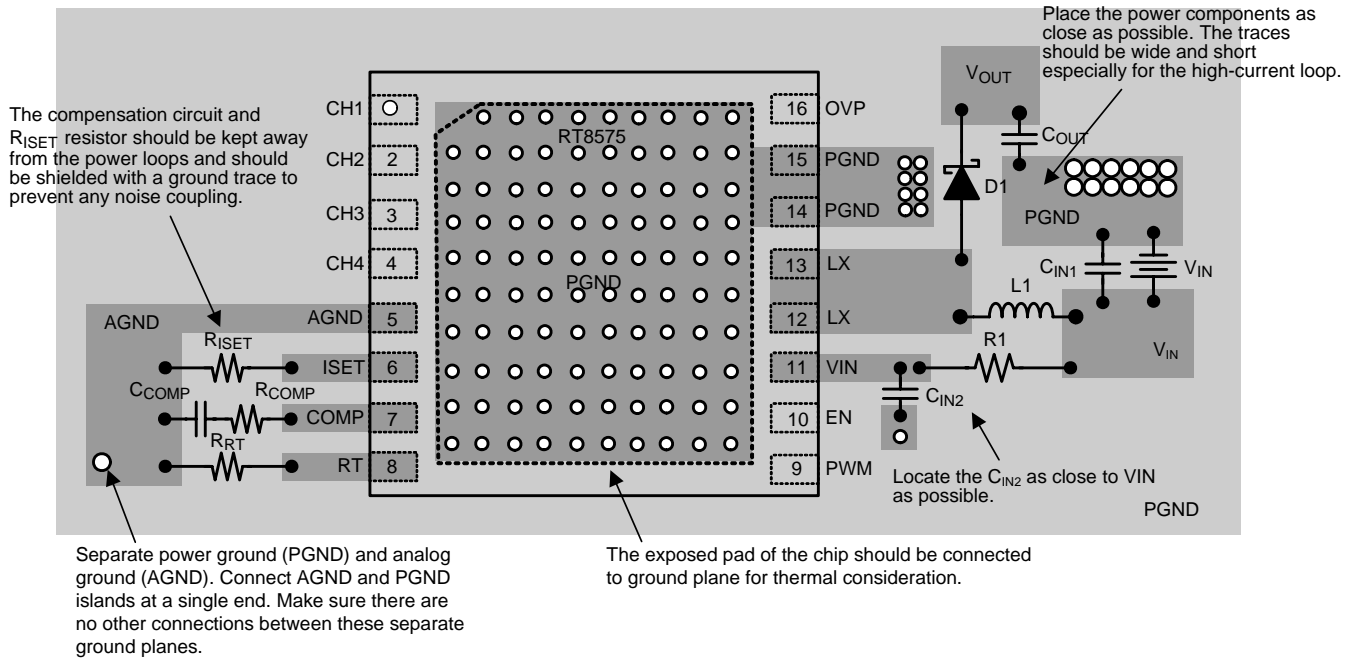
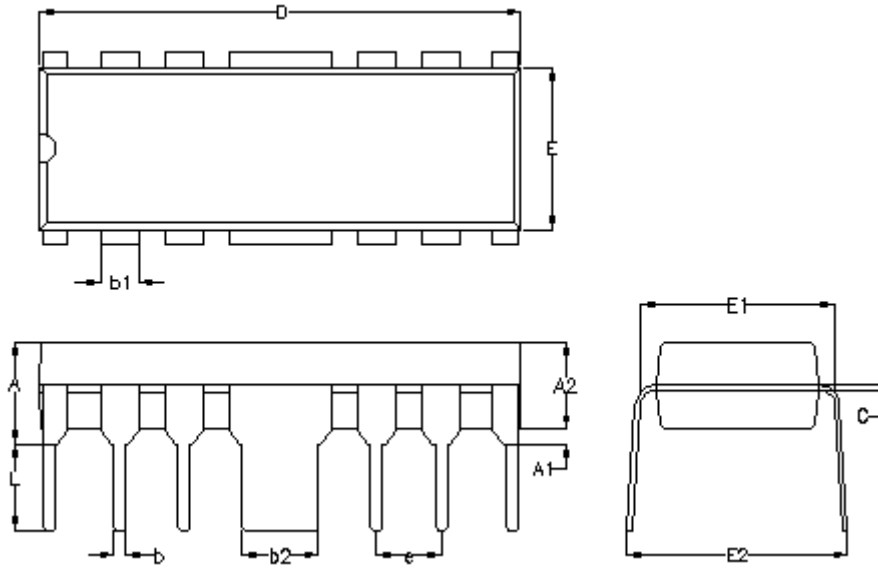

Figure 6. PCB Layout Guide for WDFN-16L 5x5 Package

Outline Dimension



Symbol	Dimensions In Millimeters		Dimensions In Inches	
	Min.	Max.	Min.	Max.
A	3.700	4.320	0.146	0.170
A1	0.381	0.710	0.015	0.028
A2	3.200	3.600	0.126	0.142
b	0.360	0.560	0.014	0.022
b1	1.143	1.778	0.045	0.070
b2	2.920	3.100	0.115	0.122
C	0.204	0.360	0.008	0.014
D	18.800	19.300	0.740	0.760
E	6.200	6.600	0.244	0.260
E1	7.320	7.920	0.288	0.312
E2	8.350	9.250	0.329	0.364
e	2.540		0.100	
L	3.000	3.600	0.118	0.142

16-Lead DIP (BW) Plastic Package

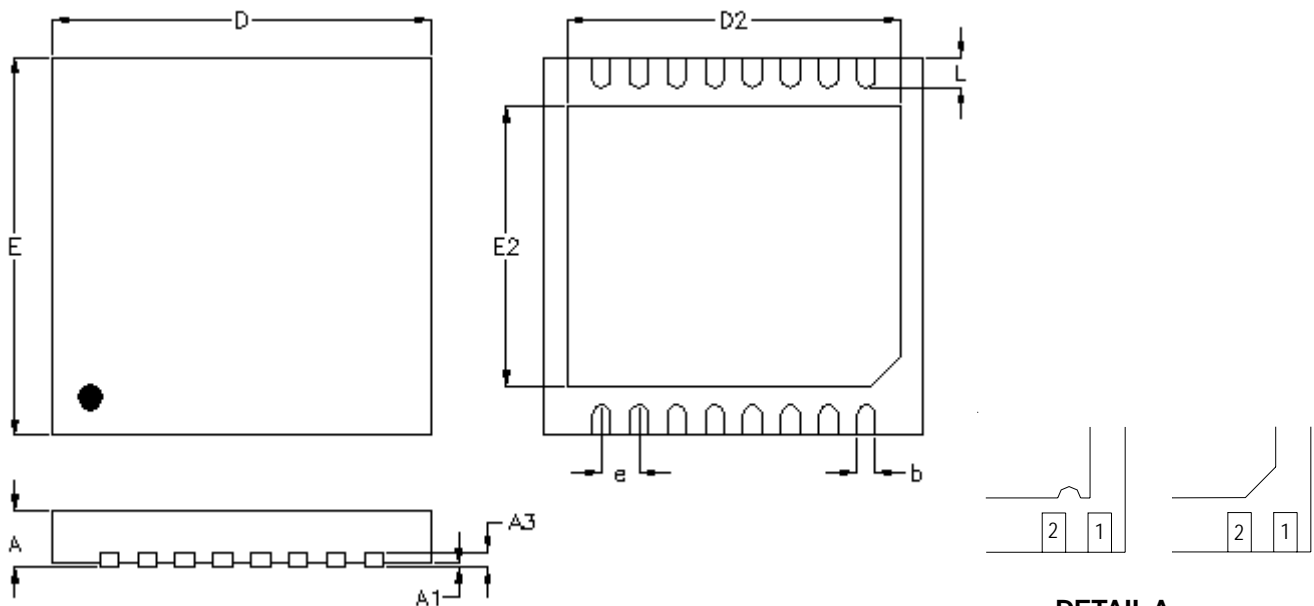

DETAIL A

Pin #1 ID and Tie Bar Mark Options

Note : The configuration of the Pin #1 identifier is optional, but must be located within the zone indicated.

Symbol	Dimensions In Millimeters		Dimensions In Inches	
	Min.	Max.	Min.	Max.
A	0.700	0.800	0.028	0.031
A1	0.000	0.050	0.000	0.002
A3	0.175	0.250	0.007	0.010
b	0.200	0.300	0.008	0.012
D	4.900	5.100	0.193	0.201
D2	4.350	4.450	0.171	0.175
E	4.900	5.100	0.193	0.201
E2	3.650	3.750	0.144	0.148
e	0.500		0.020	
L	0.350	0.450	0.014	0.018

W-Type 16L DFN 5x5 Package

Richtek Technology Corporation

5F, No. 20, Taiyuen Street, Chupei City
 Hsinchu, Taiwan, R.O.C.
 Tel: (8863)5526789

Richtek products are sold by description only. Richtek reserves the right to change the circuitry and/or specifications without notice at any time. Customers should obtain the latest relevant information and data sheets before placing orders and should verify that such information is current and complete. Richtek cannot assume responsibility for use of any circuitry other than circuitry entirely embodied in a Richtek product. Information furnished by Richtek is believed to be accurate and reliable. However, no responsibility is assumed by Richtek or its subsidiaries for its use; nor for any infringements of patents or other rights of third parties which may result from its use. No license is granted by implication or otherwise under any patent or patent rights of Richtek or its subsidiaries.